

# **EXPRESSCLUSTER<sup>®</sup> X 3.3** **for Linux**

## Reference Guide

10/02/2017

6th Edition



## Revision History

Edition	Revised Date	Description
1st	02/09/2015	New manual.
2nd	06/30/2015	Corresponds to the internal version 3.3.1-1.
3rd	01/29/2016	Corresponds to the internal version 3.3.2-1.
4th	10/03/2016	Corresponds to the internal version 3.3.3-1.
5th	04/10/2017	Corresponds to the internal version 3.3.4-1.
6th	10/02/2017	Corresponds to the internal version 3.3.5-1.

© Copyright NEC Corporation 2015. All rights reserved.

## **Disclaimer**

Information in this document is subject to change without notice. No part of this document may be reproduced or transmitted in any form by any means, electronic or mechanical, for any purpose, without the express written permission of NEC Corporation.

## **Trademark Information**

EXPRESSCLUSTER® is a registered trademark of NEC Corporation.

FastSync® is a registered trademark of NEC Corporation.

Linux is a registered trademark or trademark of Linus Torvalds in the United States and other countries.

RPM is a trademark of Red Hat, Inc.

Intel, Pentium and Xeon are registered trademarks or trademarks of Intel Corporation.

Microsoft, Windows, Windows Server, Windows Azure and Microsoft Azure are registered trademarks of Microsoft Corporation in the United States and other countries.

Amazon Web Services and all AWS-related trademarks, as well as other AWS graphic, logo, page header, button icon, script, and service names, are the trademarks, registered trademarks, or trade dresses of AWS in the United States and other countries.

Turbolinux is a registered trademark of Turbolinux, Inc.

VERITAS, VERITAS Logo and all other VERITAS product names and slogans are trademarks or registered trademarks of VERITAS Software Corporation.

Oracle, Java and all Java-based trademarks and logos are trademarks or registered trademarks of Oracle and/or its affiliates.

VMware is a registered trademark or trademark of VMware, Inc. in the United States and other countries.

Novell is a registered trademark of Novell, Inc. in the United States and Japan.

SUSE is a registered trademark of SUSE LINUX AG, a Novell business in the United States.

Citrix, Citrix XenServer, and Citrix Essentials are registered trademarks or trademarks of Citrix Systems, Inc. in the United States and other countries.

WebOTX is a registered trademark of NEC Corporation.

JBoss is a registered trademark of Red Hat, Inc. in the United States and its subsidiaries.

Apache Tomcat, Tomcat, and Apache are registered trademarks or trademarks of Apache Software Foundation.

Android is a trademark or registered trademark of Google, Inc.

Other product names and slogans written in this manual are trademarks or registered trademarks of their respective companies.





# Table of Contents

<b>Preface</b> .....	<b>xxi</b>
Who Should Use This Guide.....	xxi
How This Guide is Organized.....	xxi
EXPRESSCLUSTER Documentation Set.....	xxii
Conventions.....	xxiii
Contacting NEC.....	xxiv
<b>Section I</b> <b>Detailed reference of EXPRESSCLUSTER functions</b> .....	<b>25</b>
<b>Chapter 1</b> <b>Functions of the WebManager</b> .....	<b>27</b>
Window of the WebManager.....	28
Main pane of the WebManager.....	28
Switching the operation modes of the WebManager.....	31
Searching for an alert by using the WebManager.....	32
Collecting logs by using the WebManager.....	35
Updating the WebManager information.....	38
Changing the WebManager screen layout.....	38
Checking the time information from the WebManager.....	39
Executing Integrated WebManager from the WebManager.....	40
Operating a cluster and cluster services on the WebManager.....	41
Confirming the license from the WebManager.....	41
Checking the status of each object in the tree view of WebManager.....	42
The colors of the icons displayed in the WebManager tree view.....	43
Operations from the WebManager.....	58
Checking the cluster status by the WebManager list view.....	76
To display information on the whole cluster.....	76
Checking the whole status of the server in the WebManager list view.....	82
Checking the status of individual server in the WebManager list view.....	83
Checking the status of the whole monitor in the WebManager list view.....	84
Checking alerts using the WebManager.....	85
Alert view fields.....	85
Alert view operation.....	87
Mirror disk helper.....	89
Overview of the mirror disk helper.....	89
Operating Mirror Disk Helper.....	93
Recovering a mirror (forcefully).....	102
Stopping mirror recovery.....	106
Canceling access restriction.....	107
Disconnecting a mirror disk.....	108
Changing a current server (Only for hybrid disk resource).....	109
Manually setting WebManager to stop and start.....	110
Changing the settings without using the WebManager.....	111
Setting usage limitations.....	112
Type of limitation.....	112
Switch authorization of the WebManager.....	115
Operating a cluster by using the WebManager.....	116
Cluster shutdown and cluster shutdown reboot.....	116
Mirror disk resource, hybrid disk resource and mirror disk helper.....	116
Shutting down and rebooting an individual server.....	116
Starting, stopping, and moving an individual group.....	116
Starting and stopping an individual resource.....	116
Suspending and resuming a monitor resource.....	116
Suspending and resuming an individual monitor resource.....	116
Limitations of the WebManager.....	117
Error messages on the WebManager.....	118

## Chapter 2                      Functions of the Builder ..... 141

Overview of the Builder .....	142
Considerations for using the Builder .....	143
Limitations on using the Builder .....	144
Details on the Builder screen.....	145
Overview of the EXPRESSCLUSTER X Builder .....	145
Tree view .....	145
Table view .....	146
Table for cluster name selection .....	146
Table for server selection.....	146
Table for server name selection .....	147
Table for group selection.....	147
Table for group name selection .....	150
Table for monitor resource selection .....	151
Pop-up menu.....	152
Using a tool bar of the Builder .....	153
Using the menu bar of the Builder.....	154
File menu.....	154
Creating a new cluster .....	155
Opening the configuration file.....	155
Saving the configuration file .....	156
Get the configuration file (online version only).....	157
Apply the configuration file (online version only) .....	158
Update Server Data (online version).....	160
Changing communication settings.....	161
Changing the log level settings of Builder.....	162
Collecting Builder log .....	163
Exiting from the Builder.....	163
View menu .....	164
Operation Mode.....	164
Config Mode.....	164
Reference Mode.....	164
Verification Mode .....	164
Edit menu .....	165
Adding an object.....	165
Removing an object.....	166
Renaming an object .....	167
Properties.....	167
Help Menu .....	168
Checking the version information of the Builder.....	168
Parameter details .....	169
Cluster properties.....	169
Info tab .....	169
Interconnect tab .....	171
NP Resolution tab.....	176
Timeout tab.....	180
Port No. tab.....	181
Port No. (Mirror) tab ~ For the Replicator/Replicator DR ~ .....	183
Port No. (Log) tab.....	184
Monitor tab.....	185
Recovery tab.....	188
Alert Service tab.....	198
WebManager tab .....	206
Alert Log tab .....	212
Delay Warning tab.....	213
Exclusion tab .....	214
Mirror Agent tab ~ For the Replicator/Replicator DR~ .....	215
Mirror driver tab ~ For Replicator/Replicator DR ~ .....	217
Power saving tab.....	218
JVM monitor tab.....	219
Oracle Clusterware linkage tab.....	228
Server properties.....	229
Info tab .....	229

Warning Light tab .....	232
BMC tab.....	235
BMC(High-End Server Option) tab .....	237
Disk I/O Lockout tab.....	238
PCI Slot Lockout(High-End Server Option) tab .....	240
Functional differences of the Builder between Linux and Windows .....	241
Parameters list.....	242
Cluster.....	242
Servers .....	247
Server .....	247
Group .....	248
Group Resource (Common) .....	250
Exec resource .....	250
Disk resource .....	251
Floating IP resource .....	252
Virtual IP resource .....	252
NAS resource .....	253
Mirror disk resource.....	254
Hybrid disk resource .....	255
Volume manager resource.....	257
VM resource.....	258
Dynamic DNS resource.....	259
AWS elastic ip resource .....	259
AWS virtual ip resource.....	260
Azure probe port resource.....	260
Monitor resource (common).....	262
Disk monitor resource .....	262
IP monitor resource .....	263
Virtual IP monitor resource.....	263
PID monitor resource .....	264
User-mode monitor resource .....	264
NIC Link Up/Down monitor resource.....	265
Multi target monitor resource.....	265
Mirror disk monitor resource .....	266
Mirror disk connect monitor resource .....	266
Hybrid disk monitor resource.....	267
Hybrid disk connect monitor resource .....	267
ARP monitor resource.....	268
Custom monitor resource .....	268
Volume manager monitor resource .....	269
VM monitor resource .....	270
Message receive monitor resource .....	270
Dynamic DNS monitor resource .....	271
Process name monitor resource .....	271
BMC monitor resource.....	272
DB2 monitor resource .....	273
FTP monitor resource.....	273
HTTP monitor resource.....	274
IMAP4 monitor resource.....	275
MySQL monitor resource .....	275
NFS monitor resource .....	276
Oracle monitor resource.....	277
OracleAS monitor resource.....	278
Oracle Clusterware Synchronization Management monitor resource .....	279
POP3 monitor resource .....	279
PostgreSQL monitor resource .....	280
Samba monitor resource.....	281
SMTP monitor resource .....	282
Sybase monitor resource .....	282
Tuxedo monitor resource .....	283
Weblogic monitor resource .....	284
Websphere monitor resource.....	285
WebOTX monitor resource.....	285
JVM monitor resource.....	286
System Monitor Resource .....	288

Floating IP monitor resources .....	290
AWS elastic ip monitor resource .....	290
AWS virtual ip monitor resource .....	291
AWS AZ monitor resource .....	291
Azure probe port monitor resource .....	292
Azure load balance monitor resource .....	293
Upper limits of registration.....	294
<b>Chapter 3</b> <b>EXPRESSCLUSTER command reference.....</b>	<b>295</b>
Operating the cluster from the command line .....	296
EXPRESSCLUSTER commands .....	297
Displaying the cluster status (clpstat command).....	299
Common entry examples .....	303
Displaying the status of the cluster (-s option).....	303
Displaying a group map (-g option) .....	304
Displaying the status of monitor resources (-m option).....	305
Displaying the status of heartbeat resources (-n option).....	306
Displaying the status of network partition resolution resources (-p option).....	307
Displaying the cluster configuration data (--cl option) .....	308
Displaying only the configuration data of certain servers (--sv option) .....	314
Displaying only the resource information of certain heartbeats (--hb option) .....	315
Displaying only the configuration data of certain server group (--svg option) .....	319
Displaying only the configuration data of certain groups (--grp option) .....	320
Displaying only the configuration data of a certain group resource (--rsc option).....	321
Displaying only the configuration data of a certain monitor resource (--mon option).....	343
Displaying the configuration data of a resource specified for an individual server (--rsc option or --mon option) .....	388
Displaying all configuration data (-i option) .....	389
Displaying the status of the cluster (--local option).....	390
Status Descriptions .....	392
Operating the cluster (clpctl command) .....	395
Shutting down a specified server (clpdown command).....	399
Shutting down the entire cluster (clpstdn command) .....	400
Operating groups (clpgrp command).....	401
Collecting logs (clplogcc command) .....	408
Collecting logs by specifying a type (-t option) .....	411
Syslog generations (-r option) .....	414
Output paths of log files (-o option).....	414
Specifying log collector server (-n option).....	415
Collecting information when a failure occurs.....	415
Changing, backing up, and checking cluster configuration data (clpcfctrl command).....	417
Creating a cluster and changing the cluster configuration data.....	417
Backing up the Cluster configuration data.....	424
Adding a resource without stopping the group .....	428
Checking cluster configuration data .....	433
Adjusting time-out temporarily (clptoratio command).....	438
Modifying the log level and size (clplogcf command) .....	441
Managing licenses (clplcns command).....	451
Locking disk I/O (clproset command) .....	456
Mirror-related commands .....	458
Displaying the mirror status (clpmdstat command).....	458
Display examples.....	463
Operating mirror disk resource (clpmdctrl command) .....	470
Initializing mirror disks (clpmdinit command) .....	485
Hybrid-disk-related commands .....	489
Displaying the hybrid disk status (clphdstat command).....	489
Display examples.....	494
Operating hybrid disk resource (clphdctrl command).....	500
List of operations to switch a current server .....	514
Initializing hybrid disks (clphdinit command) .....	516

Outputting messages (clplogcmd command) .....	520
Controlling monitor resources (clpmonctrl command) .....	523
Controlling group resources (clprsc command) .....	531
Controlling reboot count (clpregctrl command) .....	536
Turning off warning light (clplamp command) .....	539
Controlling CPU frequency (clpcpufreq command) .....	540
Controlling chassis identify lamp (clpledctrl command) .....	542
Processing inter-cluster linkage (clptrnreq command) .....	544
Requesting processing to cluster servers (clprexec command) .....	546
Changing BMC information (clpbmccnf command) .....	550
Controlling cluster activation synchronization wait processing (clpbwctrl command) .....	552
Estimating the amount of resource usage (clpprer command) .....	553
Checking the process health (clphealthchk command) .....	558
<b>Section II                    Resource details .....</b>	<b>561</b>
<b>Chapter 4                    Group resource details .....</b>	<b>563</b>
Group resources and supported EXPRESSCLUSTER versions .....	564
Attributes common to group resources .....	566
Understanding the group type .....	566
Understanding the group properties .....	566
Understanding failover policy .....	571
Operations at detection of activation and inactivation errors .....	576
Script before final action .....	580
Reboot count limit .....	582
Resetting the reboot count .....	586
Group start dependence and group stop dependence .....	587
Displaying and changing the settings of group properties .....	591
Renaming a group (Group properties) .....	591
Displaying and changing the comment of a group (Group properties) .....	591
Displaying and changing the settings of servers that start up the group (Group properties) .....	591
Displaying and changing the settings of server group that starts up the group (Group properties) .....	593
Displaying and changing the group attribute (Group properties) .....	594
Understanding setting of group start dependence and group stop dependence .....	600
Displaying and configuring group start dependence and group stop dependence .....	601
Displaying and changing the settings of group resources .....	605
Renaming a group resource (Group properties) .....	605
Displaying and changing the comment of a group resource (Group properties) .....	605
Understanding the settings of dependency among group resources (Common to group resources) .....	606
Displaying and configuring the settings of dependency among group resources (Common to group resources) .....	607
Displaying and changing the operation settings when a group resource error is detected (Common to group resources) .....	609
Displaying and changing the script when a group resource activation/deactivation failure is detected .....	615
Displaying the property of the whole groups by using the WebManager .....	617
Displaying the property of a certain group by using the WebManager .....	617
Setting group resources for individual server .....	618
Understanding server groups .....	620
Displaying and changing the settings of server groups .....	621
Renaming a server group (Server group properties) .....	621
Displaying and changing the comment of a server group (Server group properties) .....	621
Displaying and changing the settings of servers belonging to a server group (Server group properties) .....	622
Displaying the server group properties with WebManager .....	623
Understanding EXEC resources .....	624
Dependency of EXEC resources .....	624
Method of judging EXEC resource activation/deactivation results .....	624
Scripts in EXEC resources .....	625
Environment variables in EXEC resource script .....	626
Execution timing of EXEC resource script .....	629
Writing EXEC resource scripts .....	643
Tips for creating EXEC resource script .....	647
Notes on EXEC Resource .....	648

Displaying and changing the EXEC resource details.....	649
Displaying and changing the EXEC resource script created by the Builder .....	651
Using the simple selection function of a script template .....	653
Displaying and changing EXEC resource script using a user application .....	654
Tuning EXEC resource.....	656
Displaying EXEC resource properties with the WebManager.....	658
Understanding disk resource .....	660
Dependencies of disk resource .....	660
Switching partitions.....	660
Device region expansion on disk resources .....	661
Notes on disk resources .....	662
Displaying and changing the details of disk resource.....	663
Displaying the disk resource properties with the WebManager.....	671
Understanding floating IP resource .....	674
Dependencies of floating IP resource .....	674
Floating IP .....	674
Notes on floating IP resource .....	676
Waiting process for floating IP resource deactivation .....	679
Displaying and changing the details of floating IP resource.....	681
Displaying the property of floating IP resource with the WebManager.....	686
Understanding virtual IP resources.....	688
Dependencies of virtual IP resources.....	688
Virtual IP resources .....	688
Determining virtual IP address .....	690
Preparing for using virtual IP resources.....	691
Controlling path.....	693
Requirement to use virtual IP address .....	694
Notes on virtual IP resources .....	695
Displaying and changing the details of virtual IP resource.....	696
Displaying the virtual IP resource properties with the WebManager .....	704
Understanding mirror disk resources.....	706
Dependencies of mirror disk resource .....	706
Mirror disk.....	706
Understanding mirror parameters .....	710
Examples of mirror disk construction.....	719
Notes on mirror disk resources .....	724
mount processing flow.....	727
umount processing flow.....	728
Conditions under which the mirror status becomes abnormal .....	729
Displaying and changing the details of mirror disk resource .....	731
Displaying the mirror disk resource property with the WebManager ~For Replicator ~.....	744
Understanding hybrid disk resources.....	747
Dependencies of hybrid disk resource .....	747
What is hybrid disk?.....	748
Mirror parameter settings .....	751
Notes on hybrid disk resources.....	752
mount processing flow.....	756
umount processing flow.....	757
Displaying and changing the details of hybrid disk resource.....	758
Displaying the hybrid disk resource property with the WebManager ~For Replicator DR~ .....	759
Understanding NAS resource .....	763
Dependencies of the NAS resource .....	763
NAS resource .....	763
Notes on NAS resource .....	763
Displaying and changing the details of NAS resource.....	765
Displaying the property of NAS resource with the WebManager .....	769
Understanding volume manager resources .....	771
Dependencies of volume manager resources .....	771
What is a Volume Manager Resource?.....	771
Notes on volume manager resources .....	772
Displaying and changing the details of the volume manager resources.....	778
Displaying the properties of a volume manager resource by using the WebManager .....	781
Understanding VM resources .....	783
Dependencies of VM resources .....	783

What is a VM resource?.....	783
Notes on VM resources.....	784
Displaying and changing the details of the VM resources .....	785
Adjusting the VM resource .....	790
Displaying the properties of a VM resource by using the WebManager .....	791
Understanding Dynamic DNS resources .....	795
Dependencies of Dynamic DNS resources.....	795
What is a Dynamic DNS resource?.....	796
Preparing to use Dynamic DNS resources .....	797
Set up the DDNS server before using Dynamic DNS resources. ....	797
Notes on Dynamic DNS resources .....	798
Displaying and changing the details of the Dynamic DNS resources .....	799
Displaying the properties of a Dynamic DNS resource by using the WebManager .....	800
Understanding AWS elastic ip resources.....	802
Dependencies of AWS elastic ip resources .....	802
What is an AWS elastic ip resource? .....	802
Notes on AWS elastic ip resources .....	802
Applying environment variables to AWS CLI run from the AWS elastic ip resource .....	802
Displaying and changing the AWS elastic ip resource details .....	803
Tuning AWS elastic ip resource.....	804
Displaying the AWS elastic ip resource properties with the WebManager.....	805
Understanding AWS virtual ip resources .....	807
Dependencies of AWS virtual ip resources .....	807
What is an AWS virtual ip resource? .....	807
Notes on AWS virtual ip resources .....	808
Applying environment variables to AWS CLI run from the AWS virtual ip resource.....	808
Displaying and changing the AWS virtual ip resource details .....	809
Tuning AWS virtual ip resources.....	810
Displaying the AWS virtual ip resource properties with the WebManager.....	811
Understanding Azure probe port resources.....	813
Dependencies of Azure probe port resources .....	813
What is an Azure probe port resource? .....	813
Notes on Azure probe port resources .....	814
Displaying and changing the details of Azure probe port resources.....	814
Tuning Azure probe port resource.....	815
Displaying the Azure probe port resource properties with the WebManager.....	816
<b>Chapter 5</b> <b>Monitor resource details .....</b>	<b>819</b>
Monitor resource.....	821
Status of monitor resources after monitoring starts.....	824
Monitor timing of monitor resource .....	825
Suspending and resuming monitoring on monitor resources.....	827
Enabling and disabling dummy failure of monitor resources .....	828
Monitoring interval for monitor resource.....	829
Action when an error is detected by monitor resource .....	834
Returning from monitor error (Normal) .....	848
Activation and deactivation error of recovery target when executing recovery operation .....	852
Recovery/pre-recovery action script .....	860
Delay warning of monitor resources .....	864
Waiting for monitor resource to start monitoring.....	865
Limiting the number of reboots when an error is detected by the monitor resource .....	868
Monitor priority of the monitor resources .....	872
Changing the name of a monitor resource.....	872
Displaying and changing the comment of a monitor resource (Monitor resource properties).....	872
Displaying and changing the settings of a monitor resource (Common to monitor resources) .....	873
Displaying and changing the settings of the time when an error is detected by a monitor resource (Common to monitor resources).....	876
IPMI command .....	883
Setting monitor resources on individual servers.....	885
Common settings for monitor resources of the monitoring option .....	887
Cautions on monitoring option monitor resources .....	888
Understanding the disk monitor resources.....	889
Monitoring by disk monitor resources .....	889
I/O size when READ is selected for disk monitor resources.....	892

Setup example when READ (raw) is selected for the disk monitor resource .....	893
Displaying and changing the details of disk monitor resources .....	894
Displaying the disk monitor resource properties with the WebManager .....	897
Understanding IP monitor resources .....	900
Monitoring by IP monitor resources .....	900
Displaying and changing IP monitor resource details.....	901
Displaying the IP monitor resource property with the WebManager.....	903
Understanding floating IP monitor resources .....	905
Monitoring by floating IP monitor resources.....	905
Note on floating IP monitor resources .....	905
Displaying and changing floating IP monitor resource details .....	906
Displaying the floating IP monitor resource properties with the WebManager .....	907
Understanding NIC Link Up/Down monitor resources .....	910
System requirements for NIC Link Up/Down monitor resource .....	910
Note on NIC Link Up/Down monitor resources .....	910
Configuration and range of NIC Link Up/Down monitoring.....	912
Displaying and changing the NIC Link Up/Down monitor resource details.....	913
Displaying the NIC Link Up/Down monitor resource property with the WebManager .....	914
Understanding mirror disk connect monitor resources .....	917
Note on mirror disk connect monitor resources.....	917
Displaying and changing the mirror disk connect monitor resource details ~For Replicator ~ .....	918
Displaying the mirror disk connect monitor resource property with the WebManager .....	919
Understanding mirror disk monitor resources .....	922
Note on mirror disk monitor resources .....	922
Displaying and changing the mirror disk monitor resource details.....	922
Displaying the mirror disk monitor resource property with the WebManager .....	923
Understanding hybrid disk connect monitor resources .....	926
Note on hybrid disk connect monitor resources.....	926
Displaying and changing the hybrid disk connect monitor resource details ~For Replicator DR~.....	927
Displaying the hybrid disk connect monitor resource property with the WebManager .....	928
Understanding hybrid disk monitor resources .....	931
Note on hybrid disk monitor resources.....	931
Displaying and changing the hybrid disk monitor resource details .....	932
Displaying the hybrid disk monitor resource property with the WebManager .....	933
Understanding PID monitor resources.....	936
Note on PID monitor resources .....	936
Setting PID monitor resources.....	936
Displaying the PID monitor resource property with the WebManager.....	937
Understanding user-mode monitor resources .....	940
Drivers that user-mode monitor resources depend.....	940
rpm that user-mode monitor resources depend .....	940
How monitor user-mode monitor resources perform monitoring .....	941
Advanced settings of user-mode monitor resource .....	941
User-mode monitor resource logic .....	942
Checking availability of IPMI .....	944
IPMI command.....	945
User-mode monitor resources.....	945
Displaying and changing the user-mode monitor resource details.....	947
Displaying the user-mode monitor resource property with the WebManager .....	950
Understanding multi target monitor resources.....	953
Notes on multi target monitor resources .....	953
Multi target monitor resource status .....	953
Example of the multi target monitor resource configuration .....	954
Displaying and changing the details of the multi target monitor resource .....	955
Tuning multi target monitor resource .....	956
Displaying the property of the multi target monitor resource with the WebManager.....	958
Understanding virtual IP monitor resources .....	960
Note on virtual IP monitor resources .....	960
Setting virtual IP monitor resources .....	960
Displaying the virtual IP monitor resource property with the WebManager .....	961
Understanding ARP monitor resources .....	964
Note on ARP monitor resources .....	964
Displaying and changing the ARP monitor resource details.....	965
Displaying the ARP monitor resource property with the WebManager .....	966



Understanding custom monitor resources .....	969
Notes on custom resources .....	969
Monitoring by custom monitor resources .....	969
Displaying and changing the details of the custom monitoring resources .....	970
Displaying the custom monitor resource properties with the Web Manager .....	974
Understanding volume manager monitor resources .....	977
Notes on volume manager monitor resources .....	977
Monitoring by volume manager monitor resources .....	977
Displaying and changing the details of the volume manager monitor resources .....	978
Displaying the properties of a volume manager monitor resource by using the WebManager .....	979
Understanding message receive monitor resources .....	982
Monitoring by message receive monitor resources .....	982
Failover to outside the server group .....	983
Notes on message receive monitor resources .....	984
Displaying and changing the details of the message receive monitor resources .....	985
Displaying and changing the error detection settings of the message receive monitor resources .....	987
Displaying the properties of a message receive monitor resource by using the WebManager .....	989
Understanding VM monitor resources .....	992
Notes on VM monitor resources .....	992
Monitoring by VM monitor resources .....	992
Displaying and changing the details of the VM monitor resources .....	993
Displaying the properties of a VM monitor resource by using the WebManager .....	994
Understanding Dynamic DNS monitor resources .....	996
Notes on Dynamic DNS monitor resources .....	996
Settings for Dynamic DNS monitor resources .....	996
Displaying the properties of a Dynamic DNS monitor resource by using the WebManager .....	997
Understanding process name monitor resources .....	999
Notes on process name monitor resources .....	999
How process name monitor resources perform monitoring .....	1001
Displaying and changing the details of the process name monitor resources .....	1001
Understanding BMC monitor resources .....	1005
Understanding DB2 monitor resources .....	1006
Note on DB2 monitor resources .....	1006
How DB2 monitor resources perform monitoring .....	1007
Displaying and changing the DB2 monitor resource details .....	1008
Displaying the DB2 monitor resource properties with the WebManager .....	1010
Understanding FTP monitor resources .....	1013
FTP monitor resources .....	1013
Monitoring by FTP monitor resources .....	1013
Displaying and changing the FTP monitor resource details .....	1014
Displaying the FTP monitor resource properties with the WebManager .....	1016
Understanding HTTP monitor resources .....	1018
Note on HTTP monitor resources .....	1018
How HTTP monitor resources perform monitoring .....	1018
Displaying and changing the HTTP monitor resource details .....	1019
Displaying the HTTP monitor resource properties with the WebManager .....	1020
Understanding IMAP4 monitor resources .....	1023
Note on IMAP4 monitor resources .....	1023
Monitoring by IMAP4 monitor resources .....	1023
Displaying and changing the IMAP4 monitor resource details .....	1024
Displaying the IMAP4 monitor resource properties with the WebManager .....	1026
Understanding MySQL monitor resources .....	1028
Note on MySQL monitor resources .....	1028
How MySQL monitor resources perform monitoring .....	1029
Displaying and changing the MySQL monitor resource details .....	1030
Displaying the MySQL monitor resource properties with the WebManager .....	1032
Understanding NFS monitor resources .....	1035
System requirements for NFS monitor resource .....	1035
Note on NFS monitor resources .....	1035
How NFS monitor resources perform monitoring .....	1035
Displaying and changing the NFS monitor resource details .....	1036
Displaying the NFS monitor resource properties with the WebManager .....	1038
Understanding Oracle monitor resources .....	1041

Note on Oracle monitor resources .....	1041
How Oracle monitor resources perform monitoring .....	1043
Displaying and changing the Oracle monitor resource details .....	1044
Displaying the Oracle monitor resource properties with the WebManager .....	1048
Understanding OracleAS monitor resources .....	1051
Notes on OracleAS monitor resources .....	1051
How OracleAS monitor resources perform monitoring .....	1051
Displaying and changing the OracleAS monitor resource details .....	1052
Displaying and changing the OracleAS monitor resource properties with the WebManager .....	1054
Understanding Oracle Clusterware Synchronization Management monitor resources .....	1057
Understanding POP3 monitor resources .....	1058
Note on POP3 monitor resources .....	1058
Monitoring by POP3 monitor resources .....	1058
Displaying and changing the POP3 monitor resource details .....	1059
Displaying the POP3 monitor resource properties with the WebManager .....	1061
Understanding PostgreSQL monitor resources .....	1063
Note on PostgreSQL monitor resources .....	1063
How PostgreSQL monitor resources perform monitoring .....	1064
Displaying and changing the PostgreSQL monitor resource details .....	1065
Displaying the PostgreSQL monitor resource properties with the WebManager .....	1067
Understanding Samba monitor resources .....	1070
Note on Samba monitor resources .....	1070
How Samba monitor resources perform monitoring .....	1070
Displaying and changing the Samba monitor resource details .....	1071
Displaying the Samba monitor resource properties with the WebManager .....	1073
Understanding SMTP monitor resources .....	1075
Note on SMTP monitor resources .....	1075
How SMTP monitor resources perform monitoring .....	1075
Displaying and changing the SMTP monitor resource details .....	1076
Displaying the SMTP monitor resource properties with the WebManager .....	1077
Understanding Sybase monitor resources .....	1080
Note on Sybase monitor resources .....	1080
How Sybase monitor resources perform monitoring .....	1081
Displaying and changing the Sybase monitor resource details .....	1082
Displaying the Sybase monitor resource properties with the WebManager .....	1084
Understanding Tuxedo monitor resources .....	1087
Note on Tuxedo monitor resources .....	1087
How Tuxedo monitor resources perform monitoring .....	1087
Displaying and changing the Tuxedo monitor resource details .....	1088
Displaying the Tuxedo monitor resource properties with the WebManager .....	1089
Understanding Weblogic monitor resources .....	1092
Note on Weblogic monitor resources .....	1092
How Weblogic monitor resources perform monitoring .....	1092
Displaying and changing the Weblogic monitor resource details .....	1093
Displaying the Weblogic monitor resource properties with the WebManager .....	1095
Understanding Websphere monitor resources .....	1098
Note on Websphere monitor resources .....	1098
How Websphere monitor resources perform monitoring .....	1098
Displaying and changing the Websphere monitor resource details .....	1099
Displaying the Websphere monitor resource properties with the WebManager .....	1101
Understanding WebOTX monitor resources .....	1104
Note on WebOTX monitor resources .....	1104
How WebOTX monitor resources perform monitoring .....	1104
Displaying and changing the WebOTX monitor resource details .....	1105
Displaying the WebOTX monitor resource properties with the WebManager .....	1108
Understanding JVM monitor resources .....	1111
Note on JVM monitor resources .....	1111
How JVM monitor resources perform monitoring .....	1111
Linking with the load balancer (health check function) .....	1115
Linking with the load balancer (target Java VM load calculation function) .....	1117
Linking with the BIG-IP Local Traffic Manager .....	1119
JVM statistics log .....	1123
Java memory area usage check on monitor target Java VM (jramemory.stat) .....	1123
Thread operation status check on monitor target Java VM (jathread.stat) .....	1124

GC operation status check on monitor target Java VM (jragc.stat) .....	1125
Virtual memory usage check on monitor target Java VM (jraruntime.stat) .....	1126
Operation status check on Work Manager of WebLogic Server (wlworkmanager.stat) .....	1126
Operation status check on Thread Pool of WebLogic Server (wlthreadpool.stat) .....	1127
Java memory pool name .....	1127
Executing a command corresponding to cause of each detected error .....	1132
Monitoring WebLogic Server .....	1137
Monitoring WebOTX .....	1139
Monitoring a Java process of the WebOTX domain agent .....	1140
Monitoring a Java process of a WebOTX process group .....	1140
Receiving WebOTX notifications .....	1141
Monitoring JBoss .....	1141
Monitoring Tomcat .....	1143
Monitoring SVF .....	1144
Monitoring iPlanet Web Server .....	1145
Displaying and changing the JVM monitor resource details .....	1146
Memory tab (when Oracle Java or OpenJDK is selected for JVM Type) .....	1150
Memory tab (when Oracle Java(usage monitoring) is selected for JVM Type) .....	1153
Memory tab (when Oracle JRockit is selected for JVM Type) .....	1155
Thread tab .....	1157
GC tab .....	1158
WebLogic tab .....	1159
Load Balancer Linkage tab .....	1162
Load Balancer Linkage tab .....	1163
Displaying the JVM monitor resource properties with the WebManager .....	1165
Understanding system monitor resources .....	1167
Notes on system monitor resource .....	1167
How system monitor resources perform monitoring .....	1168
Displaying and changing the system monitor resource details .....	1172
Displaying the system monitor resource properties with the WebManager .....	1180
Understanding AWS elastic ip monitor resources .....	1184
Notes on AWS elastic ip monitor resources .....	1184
Applying environment variables to AWS CLI run from the AWS elastic ip monitor resource .....	1184
Displaying and changing the AWS elastic ip monitor resource details .....	1184
Displaying the AWS elastic ip monitor resource property with the WebManager .....	1185
Understanding AWS virtual ip monitor resources .....	1188
Notes on AWS virtual ip monitor resources .....	1188
Applying environment variables to AWS CLI run from the AWS virtual ip monitor resource .....	1188
Displaying and changing the AWS virtual ip monitor resource details .....	1188
Displaying the AWS virtual ip monitor resource property with the WebManager .....	1189
Understanding AWS AZ monitor resources .....	1192
Notes on AWS AZ monitor resources .....	1192
Applying environment variables to AWS CLI run from the AWS AZ monitor resource .....	1192
Displaying and changing the AWS AZ monitor resource details .....	1192
Displaying the property of an AWS AZ monitor resource with the WebManager .....	1193
Understanding Azure probe port monitor resources .....	1196
Notes on Azure probe port monitor resources .....	1196
Displaying and changing the details of Azure probe port monitor resources .....	1196
Displaying the Azure probe port monitor resource properties with the WebManager .....	1197
Understanding Azure load balance monitor resources .....	1200
Note on Azure load balance monitor resources .....	1200
Displaying and changing the details of Azure load balance monitor resources .....	1200
Displaying the Azure load balance monitor resource properties with the WebManager .....	1201
<b>Chapter 6                    Heartbeat resources details.....</b>	<b>1205</b>
What are heartbeat resources? .....	1206
Understanding LAN heartbeat resources .....	1207
LAN heartbeat resources .....	1207
Displaying the property of a LAN heartbeat resource with the WebManager .....	1207
Understanding kernel mode LAN heartbeat resources .....	1208
Environment where the kernel mode LAN heartbeat resources works .....	1208
The settings of the kernel mode LAN heartbeat resources .....	1208
kernel mode LAN heartbeat resources .....	1208
Displaying the property of kernel mode LAN heartbeat resources with the WebManager .....	1209

Understanding disk heartbeat resources .....	1210
Setting the disk heartbeat resources .....	1210
Disk heartbeat resources .....	1212
Displaying the property of the disk heartbeat resource with the WebManager.....	1213
Understanding COM heartbeat resources .....	1214
Note on COM heartbeat resources.....	1214
Displaying the property of the COM heartbeat resource with the WebManager .....	1214
Understanding BMC heartbeat resources .....	1215
Notes on BMC heartbeat resources .....	1215
Displaying the property of the BMC heartbeat resource with the WebManager .....	1215
<b>Chapter 7                   Network partition resolution resources details .....</b>	<b>1217</b>
Network partitions .....	1218
Understanding the network partition resolution resources .....	1219
Understanding network partition resolution by PING method .....	1220
Settings of the PING network partition resolution resources .....	1220
Note on PING network partition resolution resource .....	1220
Displaying the properties of PING network partition resolution resources with the WebManager .....	1221
Not resolving network partition.....	1222
<b>Chapter 8                   Information on other settings .....</b>	<b>1223</b>
Shutdown monitoring .....	1224
Shutdown monitoring .....	1224
Displaying and changing the shutdown monitoring.....	1224
Shutdown monitoring method .....	1224
Setting of SIGTERM .....	1225
Using heartbeat timeout.....	1227
Timeout .....	1227
Bonding .....	1228
Floating IP resource.....	1228
Mirror disk connect .....	1231
Forced stop .....	1232
What is Forced stop? .....	1232
Conditions for performing forced stop .....	1232
Commands to be used for forced stop.....	1232
Notes on the forced stop .....	1233
Supported commands .....	1234
Script for forced stop .....	1235
What is the script for forced stop? .....	1235
Conditions for executing the script for forced stop.....	1235
Features of the script for forced stop .....	1235
Displaying and changing the details of the script for forced stop .....	1235
Notes on the script for forced stop.....	1236
Chassis Identify .....	1237
Chassis identify .....	1237
Conditions for chassis ID lamp to blink .....	1237
Behavior of the chassis ID lamp blinking when the cluster stops.....	1237
Commands to be used for chassis identify.....	1238
Notes on Chassis identify .....	1238
Supported commands .....	1238
Alert Service.....	1239
What is Alert Service?.....	1239
Notes on Alert Service.....	1240
Mail report actions.....	1240
Network Warning Light status.....	1240
Operations of SNMP trap sending .....	1241
SNMP linkage .....	1242
SNMP linkage .....	1242
EXPRESSCLUSTER MIB definitions.....	1242
SNMP trap sending.....	1243
Information acquisition by SNMP .....	1244
MIB objects acquirable with SNMP linkage .....	1245
Cluster service automatic startup prohibition after improper stop.....	1248

Cluster service automatic startup prohibition .....	1248
Displaying and changing the automatic startup prohibition setting .....	1248
Conditions for automatic startup prohibition .....	1248
Notes on automatic startup prohibition .....	1248
<b>NX7700x series linkage .....</b>	<b>1249</b>
NX7700x series linkage .....	1249
<b>Express5800/A1080a or Express5800/A1040a series linkage .....</b>	<b>1250</b>
Express5800/A1080a or Express5800/A1040a series linkage .....	1250
Notes on Express5800/A1080a or Express5800/A1040a series linkage .....	1250
Creating configuration information for using Express5800/A1080a or Express5800/A1040a series linkage .....	1251
Express5800/A1080a or Express5800/A1040a series linkage with message receive monitor resources .....	1257
Notes on Express5800/A1080a or Express5800/A1040a series linkage with message receive monitor resources .....	1257
Displaying and changing the details of message receive monitor resources .....	1258
<b>AWS elastic ip resources, AWS virtual ip resources, AWS elastic ip monitor resources, AWS virtual ip monitor resources and AWS AZ monitor resources .....</b>	<b>1259</b>
<b>Azure probe port resources, Azure probe port monitor resources, and Azure load balance monitor resources .....</b>	<b>1260</b>
Setting of the Microsoft Azure environment .....	1260
To the judgment of network partition resolution .....	1261
For an example of how to configure network partition resolution .....	1262
<b>Chapter 9                   Linkage with Server Management Infrastructure.....</b>	<b>1267</b>
Overview of the server management infrastructure .....	1268
Overview of linkage between the server management infrastructure and EXPRESSCLUSTER .....	1269
Setup of the function to link with the server management infrastructure .....	1270
Message receive monitor resources .....	1271
Notes on message receive monitor resources .....	1271
Category by a message receive monitor resource.....	1272
Displaying and changing the details of the message receive monitor resources .....	1273
Displaying and changing the error detection settings of the message receive monitor resources.....	1274
<b>Section III               Maintenance information.....</b>	<b>1277</b>
<b>Chapter 10               The system maintenance information .....</b>	<b>1279</b>
Directory structure of EXPRESSCLUSTER .....	1280
Log structure of EXPRESSCLUSTER .....	1283
How to delete EXPRESSCLUSTER logs or alerts.....	1285
Mirror statistics information collection function .....	1286
Communication ports.....	1292
Cluster driver device information .....	1295
What causes servers to shut down .....	1296
Final action for an error in resource activation or deactivation .....	1296
Action for resource activation or deactivation stall generation .....	1296
Final action at detection of an error in monitor resource.....	1298
Forced stop action .....	1298
Emergency server shutdown, emergency server reboot .....	1299
Resource deactivation error in stopping the EXPRESSCLUSTER daemon .....	1299
Stall detection in user space .....	1299
Stall detection during shutdown process .....	1299
Recovery from network partitioning .....	1299
Network partition resolution .....	1299
Mirror disk error ~For Replicator~ .....	1300
Hybrid disk error ~For Replicator DR~ .....	1300
Failure in resuming the cluster .....	1300
Configuring the settings to temporarily prevent execution of failover .....	1301
How to replace a mirror disk with a new one .....	1303
In case of replacing a mirror disk constructed with a single disk(non-RAID) .....	1303
In case of replacing a mirror disk constructed with a number of disks(RAID) .....	1306
In case of replacing mirror disks of both servers.....	1309
How to replace a server with a new one ~For a shared disk~ .....	1311
When using online version Builder .....	1311
When using offline version Builder .....	1312

How to replace a server with a new one ~For a mirror disk~ .....	1313
Replacing a server and its mirror disk (when using online version Builder) .....	1313
Replacing a server and its mirror disk (when using offline version Builder).....	1316
Using the mirror disk of the failed server (when using online version Builder) .....	1319
Using the mirror disk of the failed server (when using offline version Builder).....	1321
How to replace a server with a new one ~For a hybrid disk~ .....	1323
Replacing a server and its non-shared hybrid disk (when using online version Builder).....	1323
Replacing a server and a hybrid disk of the shared disk (when using online version Builder) .....	1325
Using the disk of the failed server (when using online version Builder) .....	1329
Replacing a server to which the shared disk is connected (when using online version Builder) .....	1331
Wait time for synchronized cluster startup .....	1332
Changing disk resources file system.....	1333
How to change disk resources file system (when using online version Builder) .....	1333
How to change disk resources file system (when using offline version Builder) .....	1334
Changing offset or size of a partition on mirror disk resource .....	1335
When not changing a device name of a partition on mirror disk resource .....	1335
When changing a device name of a partition on mirror disk resource .....	1340
Changing offset or size of a partition on hybrid disk resource .....	1345
When not changing a device name of a partition on hybrid disk resource .....	1345
When changing a device name of a partition on hybrid resource .....	1350
Changing the server configuration (add/delete).....	1356
Adding a server (when using online version) .....	1356
Adding a server (when using offline version Builder).....	1356
Deleting a server (When using online version Builder).....	1358
Deleting a server (When using offline version Builder) - When no mirror disk resources are used in a cluster - .....	1358
Deleting a server (When using offline version Builder) - When mirror disk resources are used in a cluster - .....	1359
Changing the server IP address.....	1360
Changing the interconnect IP address / mirror disk connect IP address .....	1360
Changing only the subnet mask of the interconnect IP address .....	1361
Changing the integrated WebManager IP address .....	1361
Changing only the subnet mask of the integrated WebManager IP address .....	1361
Changing the host name .....	1362
Changing the host name .....	1362
How to add a resource without stopping the group .....	1363
How to dynamically add a resource.....	1363
<b>Chapter 11                    Troubleshooting .....</b>	<b>1365</b>
Troubleshooting.....	1366
When the EXPRESSCLUSTER system does not start or end .....	1366
When activating or deactivating group resources fails .....	1372
When a monitor resource error occurs.....	1372
When a heartbeat time-out occurs .....	1374
When network partitioning occurs.....	1374
When all interconnection LANs are disconnected.....	1378
Unavailable commands when interconnections are disconnected.....	1380
Mounting mirror disks manually .....	1381
Normally mounting mirror disk when mirroring is available .....	1381
Forcibly mounting mirror disk when mirroring is not available .....	1382
Mounting hybrid disks manually .....	1385
Normally mounting mirror disk when mirroring is available .....	1385
Forcibly mounting mirror disk when mirroring is not available .....	1386
Manually running mkfs to mirror disk or hybrid disk.....	1389
Recovering from mirror breaks.....	1389
Automatically recovering from mirroring.....	1390
Checking the mirror break status with a command.....	1390
Checking the mirror recovery progress with a command .....	1392
Recovering mirror with a command .....	1393
Running the forcible mirror recovery with a command .....	1393
Running the forcible mirror recovery with a command only on one server.....	1399
Checking the mirror break status from the WebManager .....	1400
Checking the mirror recovery progress from the WebManager.....	1401
Recovering mirror using the WebManager.....	1402
Running the forcible mirror recovery using the WebManager .....	1402

Running the forcible mirror recovery from the WebManager only on one Server .....	1404
Changing current server on hybrid disk .....	1405
Changing current server with a command .....	1405
Changing current server with WebManager .....	1405
Troubleshooting problems with VERITAS volume manager .....	1406
Modifying the VERITAS volume manager configuration .....	1406
Operations of EXPRESSCLUSTER when VERITAS volume manager fails .....	1409
When a kernel page allocation error occurs ~ For Replicator / Replicator DR~ .....	1412
To confirm the progress of the fsck / xfs_repair command .....	1413
<b>Chapter 12</b> <b>Error messages.....</b>	<b>1415</b>
Messages.....	1416
Messages reported by syslog, alert, mail, and SNMP trap .....	1416
Driver syslog messages .....	1489
Mirror Driver .....	1490
Kernel mode LAN heartbeat driver.....	1507
Keepalive driver .....	1509
Detailed information in activating and deactivating group resources .....	1511
Floating IP resources .....	1511
Virtual IP resource .....	1512
Disk resources .....	1512
NAS resources .....	1513
EXEC resources .....	1515
Mirror disk resources .....	1516
Hybrid disk resources.....	1517
Volume manager resources .....	1519
VM resources .....	1519
Dynamic DNS resources .....	1520
AWS elastic ip resources .....	1520
AWS virtual ip resources .....	1521
Azure probe port resources .....	1522
Detailed info of monitor resource errors.....	1523
IP monitor resources .....	1523
Disk monitor resources .....	1523
PID monitor resources.....	1526
User-mode monitor resources .....	1526
Custom monitor resource .....	1526
Multi target monitor resources .....	1527
Mirror disk monitor resources.....	1527
Mirror disk connect monitor resources.....	1529
JVM monitor resources .....	1529
System monitor resources .....	1530
Hybrid disk monitor resources .....	1530
Hybrid disk connect monitor resources .....	1532
NIC link up/down monitor resources .....	1533
ARP monitor resources .....	1533
Virtual IP monitor resources .....	1534
VM monitor resources.....	1535
Volume manager monitor resources.....	1535
Dynamic DNS monitor resources.....	1535
Process name monitor resources .....	1536
BMC monitor resource.....	1536
Oracle Clusterware Synchronization Management monitor resource .....	1537
Floating IP monitor resources .....	1538
AWS elastic ip monitor resources .....	1539
AWS virtual ip monitor resources.....	1540
AWS AZ monitor resources .....	1540
Azure probe port monitor resources .....	1541
Azure load balance monitor resources .....	1542
Monitoring option monitor resource .....	1542
JVM monitor resource log output messages .....	1546
JVM operation log .....	1546
JVM load balancer linkage log.....	1557

<b>Appendix A</b>	<b>Glossary .....</b>	<b>1561</b>
<b>Appendix B</b>	<b>Index.....</b>	<b>1565</b>



# Preface

## Who Should Use This Guide

The *EXPRESSCLUSTER X Reference Guide* is intended for system administrators. Detailed information for setting up a cluster system, function of the product, maintenance related information, and how to troubleshoot the problems are covered in this guide. The guide provides supplemental information to the *Installation and Configuration Guide*.

## How This Guide is Organized

### Section I Detailed reference of EXPRESSCLUSTER functions

#### Chapter 1 Functions of the WebManager

Provides information on function of the EXPRESSCLUSTER X WebManager.

#### Chapter 2 Functions of the Builder

Provides information on function of the EXPRESSCLUSTER X Builder.

#### Chapter 3 EXPRESSCLUSTER command reference

Provides information on commands available to use in EXPRESSCLUSTER.

### Section II Resource details

#### Chapter 4 Group resource details

Provides information on group resource which configures a failover group.

#### Chapter 5 Monitor resource details

Provides information on monitor resource which works as a monitoring unit in EXPRESSCLUSTER.

#### Chapter 6 Heartbeat resources details

Provides information on heartbeat resource.

#### Chapter 7 Network partition resolution resources details

Provides information on heartbeat resource.

#### Chapter 8 Information on other settings

Provides information on other monitoring or notification settings.

#### Chapter 9 Linkage with Server Management Infrastructure

Provides information on linkage with Server Management Infrastructure.

### Section III Maintenance information

#### Chapter 10 The system maintenance information

Provides maintenance information for EXPRESSCLUSTER.

#### Chapter 11 Troubleshooting

Provides instruction on how to troubleshoot the problem.

#### Chapter 12 Error messages

Provides explanation on error messages displayed during EXPRESSCLUSTER operation.

### Appendix

#### Appendix A Glossary

#### Appendix B Index

# EXPRESSCLUSTER Documentation Set

The EXPRESSCLUSTER manuals consist of the following five guides. The title and purpose of each guide is described below.

## **Getting Started with EXPRESSCLUSTER**

This guide is intended for all users. The guide covers topics such as product overview, system requirements, and known problems.

## **Installation and Configuration Guide**

This guide is intended for system engineers and administrators who want to build, operate, and maintain a cluster system. Instructions for designing, installing, and configuring a cluster system with EXPRESSCLUSTER are covered in this guide.

## **Reference Guide**

This guide is intended for system administrators. The guide covers topics such as how to operate EXPRESSCLUSTER, function of each module, maintenance-related information, and troubleshooting. The guide is complement to the *Installation and Configuration Guide*.

## **EXPRESSCLUSTER X Integrated WebManager Administrator's Guide**

This guide is intended for system administrators who manage the cluster system using EXPRESSCLUSTER with Integrated WebManager and for system engineers introducing the Integrated WebManager. Details on the actual procedures required when introducing cluster system are described in this guide.

## **EXPRESSCLUSTER X WebManager Mobile Administrator's Guide**

This guide is intended for system administrators who manage a cluster system using EXPRESSCLUSTER with WebManager Mobile, and for system engineers who are introducing WebManager Mobile. Details on the actual procedures required when introducing a cluster system using WebManager Mobile are described in this guide.

## Conventions

In this guide, **Note**, **Important**, **Related Information** are used as follows:

---

**Note:**

Used when the information given is important, but not related to the data loss and damage to the system and machine.

---

---

**Important:**

Used when the information given is necessary to avoid the data loss and damage to the system and machine.

---

---

**Related Information:**

Used to describe the location of the information given at the reference destination.

---

The following conventions are used in this guide.

Convention	Usage	Example
<b>Bold</b>	Indicates graphical objects, such as fields, list boxes, menu selections, buttons, labels, icons, etc.	In <b>User Name</b> , type your name. On the <b>File</b> menu, click <b>Open Database</b> .
Angled bracket within the command line	Indicates that the value specified inside of the angled bracket can be omitted.	<code>clpstat -s[-h <i>host_name</i>]</code>
#	Prompt to indicate that a Linux user has logged in as root user.	<code># clpcl -s -a</code>
Monospace (courier)	Indicates path names, commands, system output (message, prompt, etc), directory, file names, functions and parameters.	<code>/Linux/3.3/en/server/</code>
<b>Monospace bold</b> (courier)	Indicates the value that a user actually enters from a command line.	Enter the following: <code># <b>clpcl -s -a</b></code>
<i>Monospace italic</i> (courier)	Indicates that users should replace italicized part with values that they are actually working with.	<code>rpm -i expressclsbuilder-&lt;version_number&gt;- &lt;release_number&gt;.i686.rpm</code>

# Contacting NEC

For the latest product information, visit our website below:

<http://www.nec.com/global/prod/expresscluster/>

# **Section I Detailed reference of EXPRESSCLUSTER functions**

This section explains the details of EXPRESSCLUSTER functions. Specifically, the function of the EXPRESSCLUSTER X WebManager and the Builder is described. It also gives the description of the available commands on EXPRESSCLUSTER.

- Chapter 1 Functions of the WebManager
- Chapter 2 Functions of the Builder
- Chapter 3 EXPRESSCLUSTER command reference



# Chapter 1      Functions of the WebManager

This chapter describes the functions of the WebManager.

This chapter covers:

• Window of the WebManager.....	28
• Checking the status of each object in the tree view of WebManager .....	42
• Checking the cluster status by the WebManager list view .....	76
• Checking alerts using the WebManager .....	85
• Mirror disk helper.....	89
• Manually setting WebManager to stop and start .....	110
• Changing the settings without using the WebManager .....	111
• Setting usage limitations.....	112
• Operating a cluster by using the WebManager.....	116
• Limitations of the WebManager .....	117
• Error messages on the WebManager .....	118

## Window of the WebManager

This chapter provides information about the WebManager window.

**Note:**

For the language used on the screen, see "Cluster properties Info tab" in Chapter 2 "Functions of the Builder" in this guide.

### Main pane of the WebManager

The WebManager window consists of 2 bars and 3 panes.

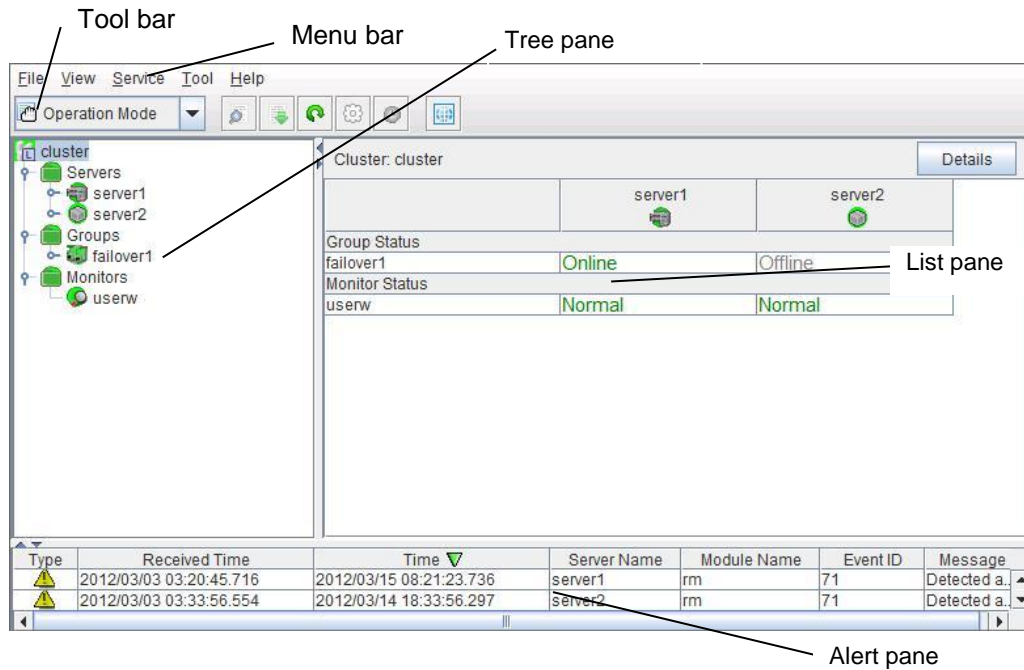

**Menu bars**

The following five menus can be selected.

- ◆ Files
- ◆ View
- ◆ Service
- ◆ Tool
- ◆ Help



## Tool bars

If you click the combo box and icons on the toolbar, you can perform the same operations as some functions of the pull-down menu displayed on the top of the screen.

Icon	Function	Refer to:
	Switches to the WebManager operation mode. This is the same as clicking <b>View</b> on the menu bar and then selecting <b>Operation Mode</b> .	Switching the operation modes of the WebManager (page 31)
	Switches to the WebManager config mode (Builder (online version)). This is the same as clicking <b>View</b> on the menu bar and then selecting <b>Config Mode</b> .	Switching the operation modes of the WebManager (page 31)
	Switches to the WebManager reference mode. This is the same as clicking <b>View</b> on the menu bar and then selecting <b>Reference Mode</b> .	Switching the operation modes of the WebManager (page 31)
	Switches to WebManager verification mode. This is the same as clicking <b>View</b> on the menu bar and then selecting <b>Verification Mode</b> .	Switching the operation modes of the WebManager (page 31)
	Searches alerts. This is the same as clicking <b>Tool</b> on the menu bar and then selecting <b>Filter Alerts</b> .	Searching for an alert by using the WebManager (page 32)
	Collect logs. This is the same as clicking <b>Tool</b> on the menu bar and then selecting <b>Collect</b> cluster logs	Collecting logs by using the WebManager (page 35)
	Performs reloading. This is the same as clicking <b>Tool</b> on the menu bar and then selecting <b>Reload</b> .	Updating the WebManager information (page 38)
	Displays the option. This is the same as clicking <b>Tool</b> on the menu bar and then selecting <b>Option</b> .	Changing the WebManager screen layout (page 38)
 	Displays the time information. This is the same as clicking <b>Tool</b> on the menu bar and then selecting <b>TimeInfo</b> . When the time information has been updated, the icon changes accordingly. The icon reverts to its original form when the time information dialog is displayed.	Checking the time information from the WebManager (page 39)

Icon	Function	Refer to:
	Displays Integrated WebManager. This is the same as clicking <b>Tool</b> on the menu bar and then selecting <b>Integrated WebManager</b> .	Executing Integrated WebManager from the WebManager (page 40)

The current mode is displayed to the right of the icon.

**Tree view**

Allows you to see a status of each cluster’s resources such as server and group resources. For more information, “Checking the status of each object in the tree view of WebManager” on page 42.

**List view**



Provides information on each cluster resource selected in the tree view in the top section and lists each server and group resource, whether each monitor resource is started or stopped, and comments in the bottom section. If you click the **Details** button located on the upper right of the view, further information will be displayed in a dialog. For more information, see “Checking the cluster status by the WebManager list view” on page 76.

**Alert view**

Shows messages describing EXPRESSCLUSTER operating status. For further information, see “Checking alerts using the WebManager” on page 85.

## Switching the operation modes of the WebManager

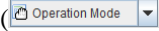
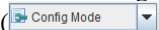
The WebManager has the following four operation modes:

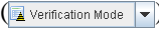
- ◆ **Operation mode**  
This mode allows the user to see the status of and operate the cluster.  
Select **Operation Mode** on the **View** menu or click the **Operation Mode** on the combo box  on the toolbar to switch to the operation mode. However, if you used the reference mode password for login when starting the WebManager or connected to the WebManager from a client that is not allowed to perform operations, it is not possible to switch to the operation mode.
- ◆ **Config mode**  
This mode allows the user to set up the cluster and change the settings. The WebManager in the config mode is called *Builder (online version)*. For details about operations in the config mode, see the next chapter.  
Select **Config Mode** on the **View** menu or click the **Config Mode** on the combo box  on the toolbar to switch to the config mode. However, if you connected to the WebManager from a client that is not allowed to perform operations, it is not possible to switch to the config mode.
- ◆ **Reference mode**  
This mode allows the user to see the cluster status, but not to operate the cluster.  
Select **Reference Mode** on the **View** menu or click the **Reference Mode** on the combo box  on the toolbar to switch to the reference mode.
- ◆ **Verification mode**  
This mode allows the user to enable or disable dummy failure of monitor resource.  
Select **Verification Mode** on the **View** menu or click **Verification Mode** in the combo box  on the toolbar to switch to verification mode. However, if you connected to the WebManager from a client that is not allowed to perform operations, it is not possible to switch to verification mode.  
If you switch from the verification mode to another mode, a dialog box asks if you want to cancel the enabled dummy failure of all the monitor resources. Select **Yes** to place all the monitor resources in the enabled dummy failure back in the normal monitored status. Select **No** to switch to another mode while keeping the monitor resources in the enabled dummy failure.

---

**Note:** When the pop-up window is displayed for **Operation Mode**, **Reference Mode**, or **Verification Mode** in the WebManager, and if switching to **Config Mode** is performed, the open pop-up window closes.

The operation performed on the pop-up window continues.

---

## Searching for an alert by using the WebManager

You can search for an alert by using the WebManager. Searching in this method is useful to view only a specific type alert.

---

**Note:**

For the information on alert logs, see “Checking alerts using the WebManager” on page 85.

---

To search for an alert, click **Filter Alerts** on the Tool menu or click the filter alerts icon (  ) on the toolbar. In the title view, click the **Filter Alerts** button to display the window for setting search conditions for an alert.

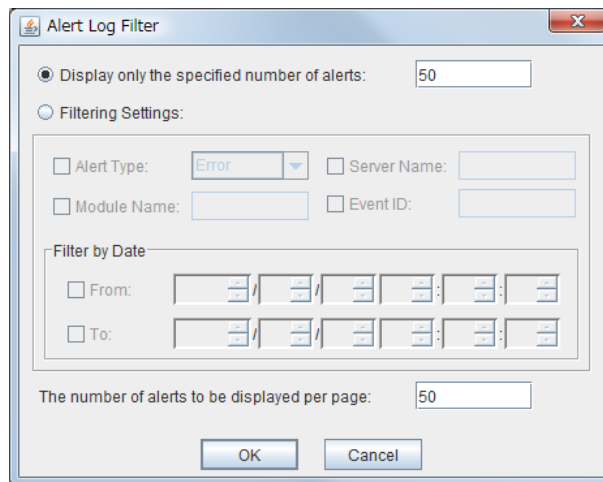

**To search only the specified number of past alert logs:**

1. Select **Display only the specified number of alerts.**
2. Enter the number of past alert logs to search, and then click **OK**. The specified number of past alerts are displayed.

---

**Note:**

The maximum alert number to enter can be configured in **Max Number to Save Alert Records**. To configure **Max Number to Save Alert Records**, right-click the cluster icon in the **Builder** and click **Properties** on the shortcut menu. In the properties dialog box click the **Alert Log** tab.

---

**To search by specifying search conditions:**

1. Click Select the filter option.
2. Enter the search conditions in each field and start searching.

**Alert Type:** Select the type of alerts.

**Module Name:** Enter the module type. The values you can enter are as follows.

Module Type	Category
pm	Whole EXPRESSCLUSTER
monp	Whole EXPRESSCLUSTER
rc	Group/resource related
rm	Monitor resource related
nm	Heartbeat resource related
apisv	API related
lanhb	LAN heartbeat resource
lankhb	Kernel mode LAN heartbeat resource
diskhb	DISK heartbeat resource
comhb	COM heartbeat resource
bmchb	BMC heartbeat resource
disk	Disk resource
fip	Floating IP resource
vip	Virtual IP resource
vipw	VIP monitor resource
ddnsw	Dynamic DNS monitor resource
vmw	VM monitor resource
userw	User-mode monitor resource
trnsv	External monitoring coordination related
mm	External monitoring coordination related
md	Mirror disk resource
hd	Hybrid disk resource
mdagent	Mirror agent related
mdadm	Mirror disk related
mdctrl	Mirror disk control command
mdinit	Mirror disk initialization command
hdctrl	Hybrid disk control command
hdinit	Hybrid disk initialization command
mdw	Mirror disk monitor resource
hdw	Hybrid disk monitor resource
cl	Cluster control command
cfmgr	Cluster configuration information operation library
logcmd	Message output command

Module Type	Category
mail	Mail report related
lamp	Network warning light report related
diskperf	Disk performance information management module
jra	JVM monitor resource
sra	System monitor resource
awseip	AWS elastic ip resource
awsvip	AWS virtual ip resource
awseipw	AWS elastic ip monitor resource
awsvipw	AWS virtual ip monitor resource
awsazw	AWS AZ monitor resource
azurepp	Azure probe port resource
azureppw	Azure probe port monitor resource
azurelbw	Azure load balance monitor resource

Server Name : Type in the name of a server whose alerts you want to see.

Event ID : Type in an event ID whose alerts you want to see.

Start Time and Stop Time: Specify the **Start Time** and **Stop Time** to narrow down the search condition using the time of the event occurrence.

3. Enter the number of alerts to display on one page in **The number of alerts to be displayed per page:** and click **OK**. Research results are displayed based on the time an alert occurred.
4. If the results of research are displayed on more than one page, move the page by clicking **Back**, **Next**, and **Jump**.

## Collecting logs by using the WebManager

Clicking **Collect Cluster Logs** on the **Tool** menu or clicking the Collect Cluster logs icon () on the toolbar opens the log collection dialog box.

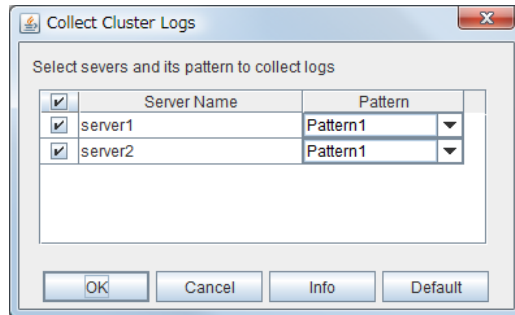

### Check box

Select check boxes of the servers that have the logs you want to collect.

### Pattern

Select the information to be collected. Specify one of Pattern 1 to Pattern 3 as the log collection pattern.

	Pattern1	Pattern2	Pattern3	Pattern4
<b>(1) Default collect Information</b>	y	y	y	y
<b>(2) syslog</b>	y	y	y	n
<b>(3) core</b>	y	y	n	y
<b>(4) OS Information</b>	y	y	y	y
<b>(5) script</b>	y	y	n	n
<b>(6) ESM/PRO/AC</b>	y	y	n	n
<b>(7) HA Logs</b>	n	y	n	n

For (1) to (7) information, see “Collecting logs (clplogcc command)” in Chapter 3, “EXPRESSCLUSTER command reference” in this guide.

### OK

Starts collect cluster logs and displays the dialog box of log collection progress.

### Cancel

Closes this dialog box.

### Info

Displays the information on each pattern.

### Default

Resets the selections of servers and collect patterns to default values.

**Cluster Log Collection Progress dialog box**

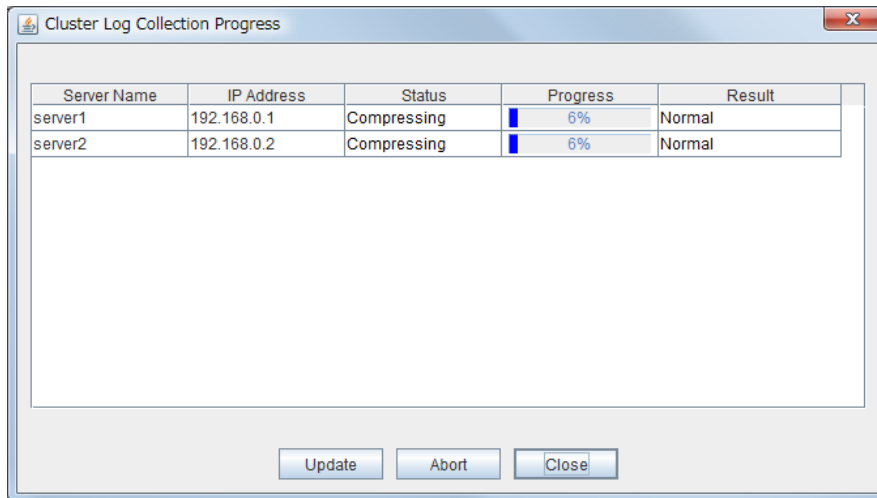

**Update**

Updates the dialog box of the **Cluster** log collection progress.

**Abort**

Aborts the **Cluster** log collection.

**Close**

Closes the dialog box of the **Cluster** log collection progress. **Cluster** Log collection is continued.

At this time, the display of the **Collect Cluster Logs** button has changed to the **Progress** button. Click **Progress** to display the progress of log collection again.

**Collect Cluster Logs Results**

Result	Description
Normal	<b>Cluster</b> Log collection succeeded.
Abort	<b>Cluster</b> Log collection was canceled by user.
Invalid Parameters	Internal error may have occurred.
Communication Error	Connecting error occurred.
Timeout	Time-out occurred.
Busy	Server is busy.
Compression Error	Error occurred when compressing a file.
File I/O Error	File I/O failed.
Not Enough Free Space	There is not enough available space on the disk.
Unknown Error	File does not exist.



When the **Cluster** log collection completes, the browser displays a **Save** dialog box that asks where you want to save the logs. Download the logs to any location.

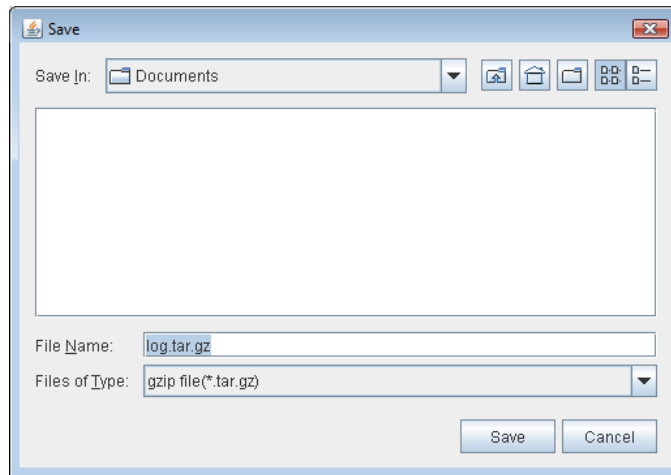

---

**Note:**

Logs may not be downloaded properly if nothing is changed for more than 10 minutes.

When you collect logs, the following message may be displayed in the server console.

```
hda: bad special flag: 0x03
ip_tables: (C) 2000-2002 Netfilter core team
```

This will not affect log collection. Ignore this message.

---

**Note:**

If other modal dialog is displayed while **Cluster** collecting logs, the file saving dialog for the **Cluster** log collection will not be displayed. To display the file saving dialog, close the modal dialog.

---

## Updating the WebManager information

Update the information displayed in the WebManager by clicking the **Reload** button in the title view in the upper part of the WebManager.

Click **Reload** on the **Tool** menu or click the reload icon () on the toolbar.

---

### Note:

When **RealTime** is set for the client data update method, what is displayed for the WebManager is updated automatically

When **Polling** is set for the client data update method, what is displayed for the WebManager is generally updated automatically, however, it does not always display the latest status because of the refresh interval configuration.

To display the latest information, click the reload icon or **Reload** on the **Tool** menu after performing an operation.

To configure the client data update method, from the shortcut menu, select **Properties**. In the properties dialog box, click the **WebManager** tab. Select the **Client Data Update Method** on **Tuning**.

To configure the automatic reload interval of the WebManager, from the shortcut menu, select **Properties**. In the properties dialog box, click the **WebManager** tab. Configure the **Reload Interval**.

Some objects may be displayed in gray when communications to the connecting destination is disabled or EXPRESSCLUSTER is not working at the access destination.



---

## Changing the WebManager screen layout

The WebManager screen layout can be changed by clicking the split bar buttons or dragging the bars.

The split bars divide the views in the WebManager.



On the bar, click  to maximize the view. Click  to minimize it.

To change the display items on the tree view, click **Option** on the **Tool** menu or option icon () on the tool bar.

The following dialog is displayed. Check items you want to display.

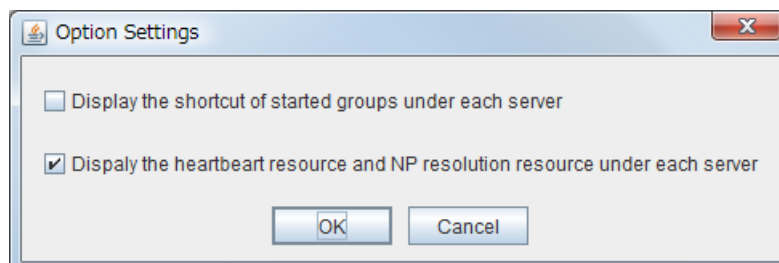

## Checking the time information from the WebManager

Check the time information from the WebManager by clicking **Time info** on the **Tool** menu or by clicking the time information icon (  ) on the toolbar.

### Time information displayed on the Server tab

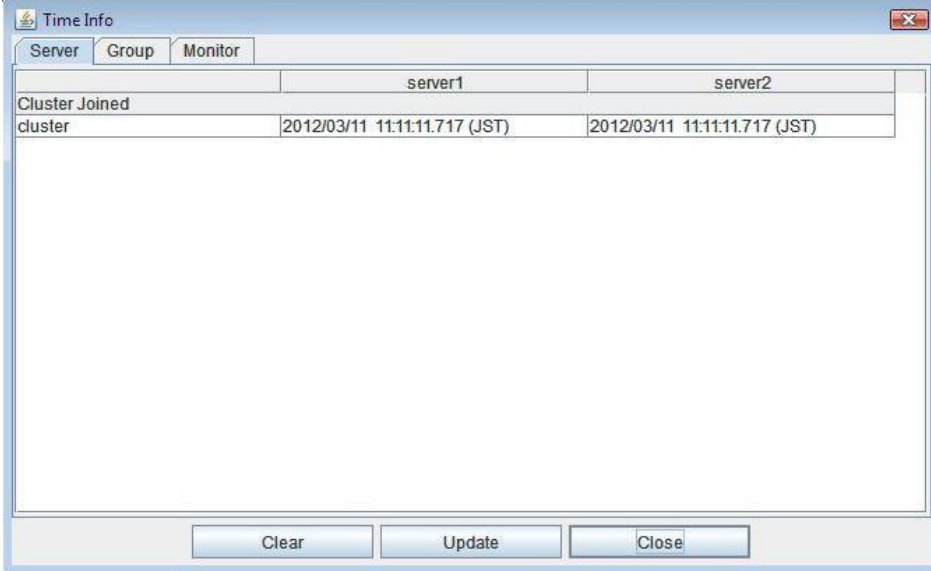

	server1	server2
Cluster Joined		
cluster	2012/03/11 11:11:11.717 (JST)	2012/03/11 11:11:11.717 (JST)

- ◆ Cluster joined  
Displays the most recent time at which each server joined the cluster.

### Time information displayed on the Group tab

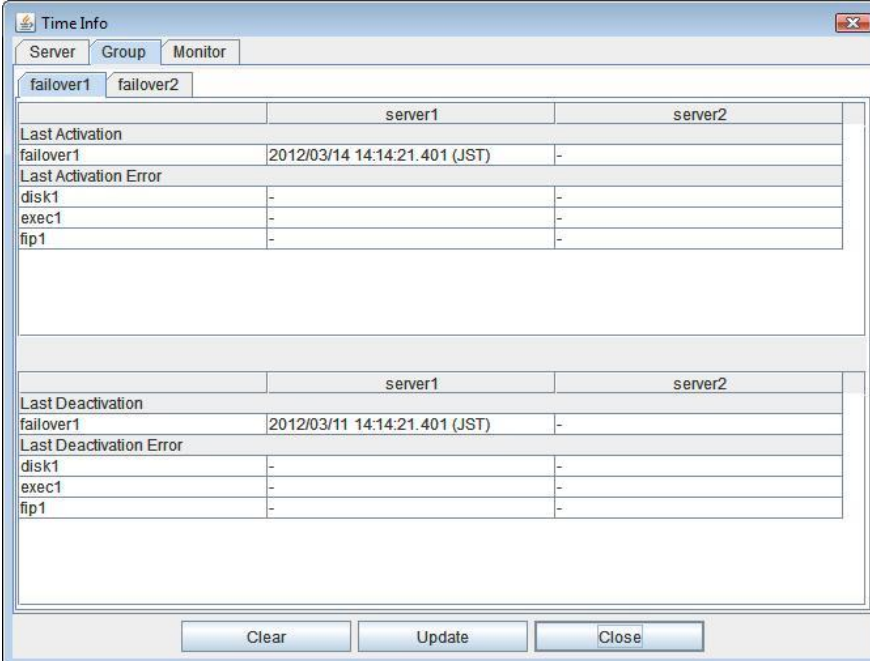

	server1	server2
Last Activation		
failover1	2012/03/14 14:14:21.401 (JST)	-
Last Activation Error		
disk1	-	-
exec1	-	-
fip1	-	-
Last Deactivation		
failover1	2012/03/11 14:14:21.401 (JST)	-
Last Deactivation Error		
disk1	-	-
exec1	-	-
fip1	-	-

- ◆ Last activation  
Displays the time at which the failover group was last activated on each server.

- ◆ Last activation error  
Displays the time at which an activation failure of a group resource was last detected on each server.
- ◆ Last deactivation  
Displays the time at which the failover group was last deactivated on each server.
- ◆ Last deactivation error  
Displays the time at which a deactivation failure of a group resource was last detected on each server.

**Time information displayed on the Monitor tab**

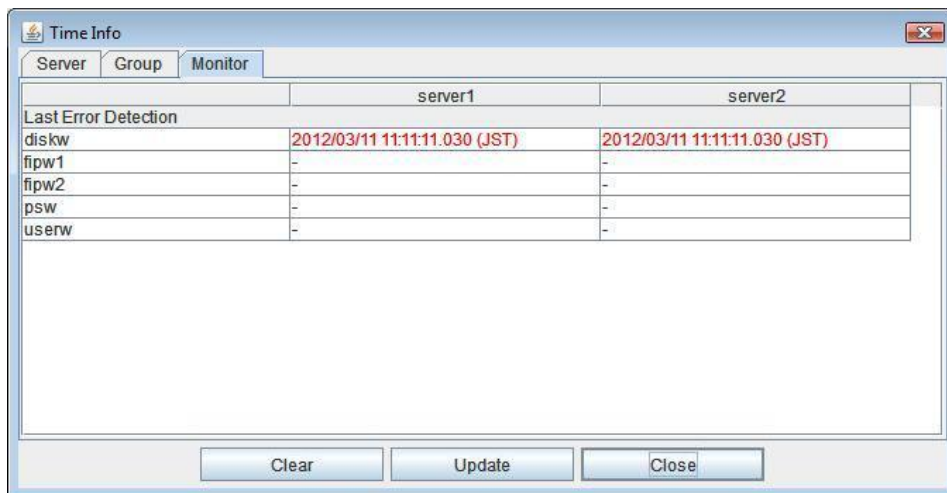

- ◆ Last error detection  
Displays the time at which each monitor resource last transitioned from normal status to abnormal status on each server.

**Clear**

Deletes the time information displayed on the current tab.

**Update**

Acquires the time information for all the tabs.

**Close**

Closes the time information dialog box.

---

**Note:**

When **Client Data Update Method** is set to **Polling**, the time information icon on the toolbar may be blinked if you push **Clear** button. But it's not a problem.

---

## Executing Integrated WebManager from the WebManager

To execute Integrated WebManager from the WebManager, click **Integrated WebManager** on the **Tool** menu or Integrated WebManager icon (  ) on the tool bar.

## Operating a cluster and cluster services on the WebManager

Operate cluster services on the WebManager by clicking each of the following items on the **Service** menu.

**Suspend Cluster, Resume Cluster, Start Cluster, Stop Cluster, Restart Manager, Start Mirror Agent, Stop Mirror Agent** are displayed. Clicking these items perform the following operations.

- ◆ **Suspend Cluster**  
Suspends a cluster. This menu can be selected only when all the servers in a cluster are running.
- ◆ **Resume Cluster**  
Resumes a suspended cluster. This menu can be selected only when all the servers in a cluster are suspended. The status of the group and the group resource of the resumed cluster when suspended is kept.
- ◆ **Start Cluster**  
Starts a cluster. This menu can be selected only when a cluster is stopped.
- ◆ **Stop Cluster**  
Stops a cluster. This menu can be selected only when a cluster is running.
- ◆ **Restart Manager**  
Restarts a manager.
- ◆ **Start Mirror Agent**  
Starts a mirror agent. This menu can be selected when the cluster is stopped regardless of the mirror agent status.
- ◆ **Stop Mirror Agent**  
Stops a mirror agent. This menu can be selected when the cluster is stopped regardless of the mirror agent status.

## Confirming the license from the WebManager

To confirm the license from the WebManager, click **License Info** on the **Help** menu.

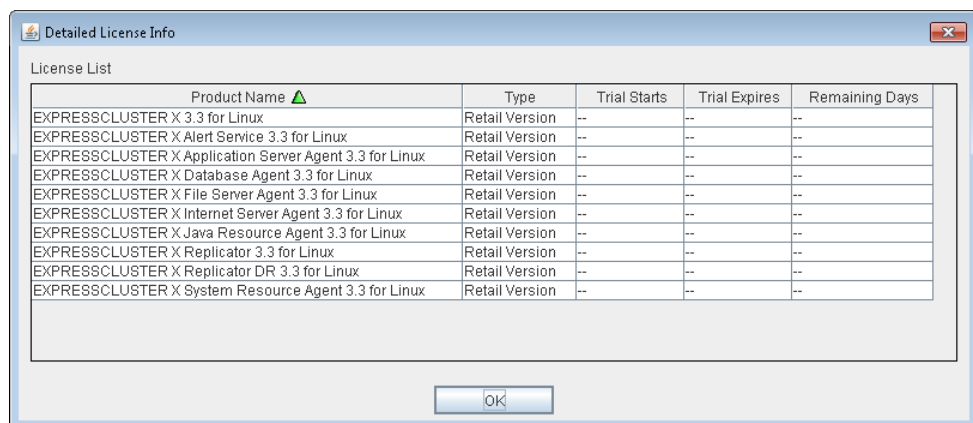

The screenshot shows a dialog box titled "Detailed License Info" with a close button in the top right corner. Below the title bar is a "License List" section containing a table with the following columns: Product Name, Type, Trial Starts, Trial Expires, and Remaining Days. The table lists ten different license products, all of which are "Retail Version" and have "--" in the Trial Starts, Trial Expires, and Remaining Days columns. An "OK" button is located at the bottom center of the dialog box.

Product Name ▲	Type	Trial Starts	Trial Expires	Remaining Days
EXPRESSCLUSTER X 3.3 for Linux	Retail Version	--	--	--
EXPRESSCLUSTER X Alert Service 3.3 for Linux	Retail Version	--	--	--
EXPRESSCLUSTER X Application Server Agent 3.3 for Linux	Retail Version	--	--	--
EXPRESSCLUSTER X Database Agent 3.3 for Linux	Retail Version	--	--	--
EXPRESSCLUSTER X File Server Agent 3.3 for Linux	Retail Version	--	--	--
EXPRESSCLUSTER X Internet Server Agent 3.3 for Linux	Retail Version	--	--	--
EXPRESSCLUSTER X Java Resource Agent 3.3 for Linux	Retail Version	--	--	--
EXPRESSCLUSTER X Replicator 3.3 for Linux	Retail Version	--	--	--
EXPRESSCLUSTER X Replicator DR 3.3 for Linux	Retail Version	--	--	--
EXPRESSCLUSTER X System Resource Agent 3.3 for Linux	Retail Version	--	--	--

- ◆ **Registered License List**  
Displays the licenses registered on the connection destination server. You can rearrange each item by selecting the field name from the list. By default, the items are arranged in descending order of **Product Name**.
- ◆ **OK button**  
Closes the **License Info** dialog box.

## Checking the status of each object in the tree view of WebManager

View the status of objects that configure the cluster on the WebManager.

1. Start the WebManager.
2. On the left pane of the window, a tree is displayed. Check the status by icon and object color.

---



















**Note:**

The configurations of the tree depend on the versions and option products of EXPRESSCLUSTER.

---























## The colors of the icons displayed in the WebManager tree view





















The following table shows icons and their meanings:



No.	Icon	Status	Description
(1)	Cluster	 Normal	All servers, group resources, and monitor resources are in a normal status.
		 Warning	One or more servers, or group resources, or monitor resource has an error or is in a warning status.
		 Error	All servers are down or in the error status.
(2)	All servers	 Normal	All servers have been started.
		 Warning	One or more servers in the cluster are not working.
		 -	-
		 Unknown	No information is acquired.
(3)	Individual server	 Online	The server is running normally.
		 Warning	One or more servers in the cluster cannot be accessed.
		 Offline or Unknown	The server is not working, or no information is acquired.
(4)	Individual server (Virtual machine)	 Online	The server is running normally.
		 Warning	One or more servers in the cluster cannot be accessed.
		 Offline or Unknown	The server is not working, or no information is acquired.
(5)	LAN heartbeat resource	 Normal	The resource can communicate with all servers.
		 Warning	One or more servers in the cluster cannot be accessed.
		 Error	The resource is not working normally.
		 Unknown	No status is acquired.
		 Not Used	The heartbeat resource is not registered.











No.	Icon	Status	Description
(6)		Normal	The resource can communicate with all servers.
		Warning	One or more servers in the cluster cannot be accessed.
		Error	The resource is not working normally.
		Unknown	No status is acquired.
		Not Used	The heartbeat resource is not registered.
(7)		Normal	The resource can communicate with all servers.
		Warning	One or more servers in the cluster cannot be accessed.
		Error	The resource is not working normally.
		Unknown	No status is acquired.
		Not Used	The heartbeat resource is not registered.
(8)		Normal	The resource can communicate with all servers.
		Warning	One or more servers in the cluster cannot be accessed.
		Error	The resource is not working normally.
		Unknown	No status is acquired.
		Not Used	The heartbeat resource is not registered.
(9)		Normal	The resource can communicate with all servers.
		Warning	One or more servers in the cluster cannot be accessed.
		Error	The resource is not working normally.
		Unknown	No status is acquired.
		Not Used	The heartbeat resource is not registered.
(10)		Normal	A response to ping command is sent from a ping target.
		Warning	-
		Error	A response to ping command is not sent from a ping target.
		Unknown	No information is acquired.
		Not Used	The ping network partition resolution resource is not registered.



No.	Icon	Status	Description	
(11)	All groups		Normal	All groups are running normally.
			Warning	One or more groups are not running normally.
			Error	No groups are working normally.
			Unknown	No information is acquired.
(12)	Individual group		Online	The group has been started.
			Error	The group has an error.
			Offline or Unknown	The group is stopped, or no information is acquired.
(13)	Disk resource		Online	The disk resource has been started.
			Error	The disk resource has an error.
			Offline or Unknown	The disk resource is stopped, or no information is acquired.
(14)	EXEC resource		Online	The Exec resource has been started.
			Error	The Exec resource has an error.
			Offline or Unknown	The Exec resource is stopped, or no information is acquired.
(15)	Floating IP resource		Online	The floating IP resource has been started.
			Error	The floating IP resource has an error.
			Offline or Unknown	The floating IP resource is stopped/ no information is acquired.
(16)	Mirror disk resource		Online	The mirror disk resource has been started.
			Error	The mirror disk resource has an error.
			Offline or Unknown	The mirror disk resource is stopped, or no information is acquired.
(17)	Hybrid disk resource		Online	The hybrid disk resource has been started.
			Error	The hybrid disk resource has an error.
			Offline or Unknown	The hybrid disk resource is stopped, or no information is acquired.

No.	Icon	Status	Description	
(18)	NAS resource		Online	The NAS resource has been started.
			Error	The NAS resource has an error.
			Offline or Unknown	The NAS resource is stopped, or no information is acquired.
(19)	Volume manager resource		Online	The volume manager resource has been started.
			Error	The volume manager resource has an error.
			Offline or Unknown	The volume manager resource is stopped, or no information has been acquired.
(20)	Virtual IP resource		Online	The virtual IP resource has been started.
			Error	The virtual IP resource has an error.
			Offline or Unknown	The virtual IP resource is stopped, or no information is acquired.
(21)	Virtual machine resource		Online	The virtual machine resource has been started.
			Error	The virtual machine resource has an error.
			Offline or Unknown	The virtual machine resource is stopped, or no information is acquired.
(22)	Dynamic DNS resource		Online	The Dynamic DNS resource has been started.
			Error	The Dynamic DNS resource has an error.
			Offline or Unknown	The Dynamic DNS resource is stopped, or no information has been acquired.
(23)	AWS elastic ip resource		Normal	The AWS elastic ip resource is running normally.
			Error	The AWS elastic ip resource has an error.
			Offline or Unknown	The AWS elastic ip resource is stopped, or no information is acquired.
(24)	AWS virtual ip resource		Normal	The AWS virtual ip resource is running normally.
			Error	The AWS virtual ip resource has an error.
			Offline or Unknown	The AWS virtual ip resource is stopped, or no information is acquired.



























No.	Icon	Status	Description	
(25)	Azure probe port resource		Normal	The Azure probe port resource is running normally.
			Error	The Azure probe port resource has an error.
			Offline or Unknown	The Azure probe port resource is stopped, or no information is acquired.

























No.	Icon	Status	Description	
(26)	All monitor resources <sup>1</sup>		Normal	All monitor resources are running normally.
			Warning	One or more monitor resources have an error, or monitoring is suspended on a server.
			Error	All monitor resources have errors.
			Normal (Dummy Failure)	In the normal status, dummy failure enabled.
			Warning (Dummy Failure)	In the warning status, dummy failure enabled.
			Error (Dummy Failure)	In the error status, dummy failure enabled.
			Normal (Recovery Action Disabled)	In the normal status, the recovery action disabled.
			Warning (Recovery Action Disabled)	In the warning status, the recovery action disabled.
			Error (Recovery Action Disabled)	In the error status, the recovery action disabled.
			Normal (Dummy Failure and Recovery Action Disabled)	In the normal status, the recovery action disabled and dummy failure enabled.
			Warning (Dummy Failure and Recovery Action Disabled)	In the warning status, the recovery action disabled and dummy failure enabled.































<sup>1</sup> When restraining recovery action at the time of monitor resource abnormality, "Recovery Action Disabled" is indicated next to monitor. When the monitor resource by which pseudo-failures occur exists, "Failure Verification" is indicated.

No.	Icon	Status	Description	
		Error (Dummy Failure and Recovery Action Disabled)	In the error status, the recovery action disabled and dummy failure enabled.	
		Unknown	No information is acquired.	
(27)	Disk monitor resource <sup>2</sup>		Normal	The disk is running normally.
			Warning	There are one or more servers with disk problems, or monitoring is suspended on a server.
			Error	All servers have disk errors.
			Dummy Failure	Dummy failure is enabled.
			Unknown	No information is acquired.
(28)	IP monitor resource <sup>2</sup>		Normal	The IP address of a target has no error.
			Warning	One or more servers cannot communicate with the IP address of the target, or monitoring is suspended on a server.
			Error	No servers can communicate with the IP address of the target.
			Dummy Failure	Dummy failure is enabled.
			Unknown	No information is acquired.
(29)	NIC Link Up/Down monitor resource <sup>2</sup>		Normal	The NIC of a target has no error.
			Warning	One of servers has a problem with the NIC of the target, or monitoring is suspended on a server.
			Error	All servers have errors with the NIC of the target.
			Dummy Failure	Dummy failure is enabled.
			Unknown	No information is acquired.
(30)	Mirror disk connect monitor resource		Normal	The mirror disk connect is running normally.
			Warning	One of the servers has mirror disk connect problems, or monitoring is suspended on a server.
			Error	A mirror disk connect error has occurred on both servers.
			Unknown	No information is acquired.

























<sup>2</sup> When dummy failure, "Dummy Failure" is indicated.

























No.	Icon	Status	Description	
(31)		Normal	The mirror disk is running normally.	
			Warning	Mirroring is now being recovered, or monitoring is suspended on a server.
			Error	The mirror disk has an error. Mirror recovery is needed.
			Unknown	No information is acquired.
(32)		Normal	Hybrid disk connect is running normally.	
			Warning	One of the servers has hybrid disk connect problems, or monitoring is suspended on a server.
			Error	Hybrid disk connect error has occurred on both servers.
			Unknown	No information is acquired.
(33)		Normal	Hybrid disk is running normally.	
			Warning	Mirroring for hybrid disk is now being recovered, or monitoring is suspended on a server.
			Error	Hybrid disk is not working normally. Mirror recovery must be performed.
			Unknown	No information is acquired.
(34)		Normal	AP is running normally.	
			Warning	There are one or more servers on which monitoring is suspended.
			Error	AP is not working normally.
			Dummy Failure	Dummy failure is enabled.
			Unknown	No information is acquired.
(35)		Normal	User space is running normally.	
			Warning	User space is not working on one or more servers, or monitoring is suspended on a server.
			Error	User space is not working on all servers.
			Unknown	No information is acquired.
(36)		Normal	Multi target monitor resource is running normally.	
			Warning	Monitoring is suspended on a server, or one or more monitor resources registered in the multi target monitor resource have errors.
			Error	Multi target has an error.
			Dummy Failure	Dummy failure is enabled.
			Unknown	No information is acquired.



























No.	Icon	Status	Description
(37)	Virtual IP monitor resource		Normal Virtual IP monitor resource is running normally.
			Warning -
			Error Virtual IP monitor resource has an error.
			Unknown No information is acquired.
(38)	ARP monitor resource		Normal ARP monitor resource is running normally.
			Warning -
			Error ARP monitor resource has an error.
			Unknown No information is acquired.
(39)	Custom monitor resource <sup>2</sup>		Normal Custom monitor resource is running normally.
			Warning -
			Error Custom monitor resource has an error.
			Dummy Failure Dummy failure is enabled.
			Unknown No information is acquired.
(40)	VM monitor resource		Normal VM is running normally.
			Warning The Virtual machine is not working on one or more servers, or monitoring is suspended on a server.
			Error VM has an error.
			Unknown No information has been acquired.
(41)	Message receive monitor resource		Normal No error message has been received.
			Warning A server has received an error message, or monitoring is suspended on a server.
			Error An error message has been received.
			Unknown No information has been acquired.
(42)	Dynamic DNS monitor resource		Normal Dynamic DNS is running normally.
			Warning -
			Error Dynamic DNS has an error.
			Unknown No information has been acquired.





















No.	Icon	Status	Description	
(43)	Process name monitor resource <sup>2</sup>		Normal	Process is running normally.
			Warning	There are one or more servers on which monitoring is suspended.
			Error	Process is not working normally.
			Dummy Failure	Dummy failure is enabled.
			Unknown	No information is acquired.
(44)	Oracle monitor resource <sup>2</sup>		Normal	Oracle is running normally.
			Warning	Oracle monitor resource is suspended.
			Error	Oracle has an error.
			Dummy Failure	Dummy failure is enabled.
			Unknown	No information is acquired.
(45)	DB2 monitor resource <sup>2</sup>		Normal	DB2 is running normally.
			Warning	DB2 monitor resource is suspended.
			Error	DB2 has an error.
			Dummy Failure	Dummy failure is enabled.
			Unknown	No information is acquired.
(46)	PostgreSQL monitor resource <sup>2</sup>		Normal	PostgreSQL is running normally.
			Warning	PostgreSQL monitor resource is suspended.
			Error	PostgreSQL has an error.
			Dummy Failure	Dummy failure is enabled.
			Unknown	No information is acquired.
(47)	MySQL monitor resource <sup>2</sup>		Normal	MySQL is running normally.
			Warning	MySQL monitor resource is suspended.
			Error	MySQL has an error.
			Dummy Failure	Dummy failure is enabled.
			Unknown	No information is acquired.
(48)	Sybase monitor resource <sup>2</sup>		Normal	Sybase is running normally.
			Warning	Sybase monitor resource is suspended.
			Error	Sybase has an error.
			Dummy Failure	Dummy failure is enabled.
			Unknown	No information is acquired.















No.	Icon	Status	Description	
(49)	Samba monitor resource <sup>2</sup>		Normal	Samba is running normally.
			Warning	The Samba is not working in one or more servers, or monitoring is suspended on a server.
			Error	Samba has an error.
			Dummy Failure	Dummy failure is enabled.
			Unknown	No information is acquired.
(50)	NFS monitor resource <sup>2</sup>		Normal	NFS is running normally.
			Warning	The NFS is not working in one or more servers, or monitoring is suspended on a server.
			Error	NFS has an error.
			Dummy Failure	Dummy failure is enabled.
			Unknown	No information is acquired.
(51)	HTTP monitor resource <sup>2</sup>		Normal	HTTP is running normally.
			Warning	The PostgreSQL is not working in one or more servers, or monitoring is suspended on a server.
			Error	HTTP has an error.
			Dummy Failure	Dummy failure is enabled.
			Unknown	No information is acquired.
(52)	FTP monitor resource <sup>2</sup>		Normal	FTP is running normally.
			Warning	FTP is not working in one or more servers, or monitoring is suspended on a server.
			Error	FTP has an error.
			Dummy Failure	Dummy failure is enabled.
			Unknown	No information is acquired.
(53)	SMTP monitor resource <sup>2</sup>		Normal	SMTP is running normally.
			Warning	The SMTP is not working in one or more servers, or monitoring is suspended on a server.
			Error	SMTP has an error.
			Dummy Failure	Dummy failure is enabled.
			Unknown	No information is acquired.

No.	Icon	Status	Description	
(54)		Normal	POP3 is running normally.	
			Warning	POP3 is not working in one or more servers, or monitoring is suspended on a server.
			Error	POP3 has an error.
			Dummy Failure	Dummy failure is enabled.
			Unknown	No information is acquired.
(55)		Normal	IMAP4 is running normally.	
			Warning	IMAP4 is not working in one or more servers, or monitoring is suspended on a server.
			Error	IMAP4 has an error.
			Dummy Failure	Dummy failure is enabled.
			Unknown	No information is acquired.
(56)		Normal	Tuxedo is running normally.	
			Warning	Tuxedo monitor resource is suspended.
			Error	Tuxedo has an error.
			Dummy Failure	Dummy failure is enabled.
			Unknown	No information is acquired.
(57)		Normal	WebSphere is running normally.	
			Warning	WebSphere monitor resource is suspended.
			Error	WebSphere has an error.
			Dummy Failure	Dummy failure is enabled.
			Unknown	No information is acquired.
(58)		Normal	WebLogic is running normally.	
			Warning	WebLogic monitor resource is suspended.
			Error	WebLogic has an error.
			Dummy Failure	Dummy failure is enabled.
			Unknown	No information is acquired.

No.	Icon	Status	Description	
(59)	WebOTX monitor resource <sup>2</sup>		Normal	WebOTX is running normally.
			Warning	WebOTX monitor resource is suspended.
			Error	WebOTX has an error.
			Dummy Failure	Dummy failure is enabled.
			Unknown	No information is acquired.
(60)	OracleAS monitor resource <sup>2</sup>		Normal	OracleAS is running normally.
			Warning	OracleAS monitor resource is suspended.
			Error	OracleAS has an error.
			Dummy Failure	Dummy failure is enabled.
			Unknown	No information is acquired.
(61)	JVM monitor resource <sup>2</sup>		Normal	JAVA VM is running normally.
			Warning	The JVM monitor resource is suspended.
			Error	JAVA VM has an error.
			Dummy Failure	Dummy failure is enabled.
			Unknown	No information is acquired.
(62)	System monitor resource <sup>2</sup>		Normal	System Resource Agent is running normally.
			Warning	Monitoring is suspended on a server.
			Error	System Resource Agent has an error.
			Dummy Failure	Dummy failure is enabled.
			Unknown	No information is acquired.
(63)	Floating IP monitor resource <sup>2</sup>		Normal	Floating IP is running normally.
			Warning	Monitoring is suspended on a server.
			Error	Floating IP has an error.
			Dummy Failure	Dummy failure is enabled.
			Unknown	No information is acquired.
(64)	BMC monitor resource <sup>2</sup>		Normal	BMC is running normally.
			Warning	Monitoring is suspended on a server.

No.	Icon	Status	Description	
		Error	BMC has an error.	
		Dummy Failure	Dummy failure is enabled.	
		Unknown	No information is acquired.	
(65)	Oracle Clusterware Synchronization Management monitor resource <sup>2</sup>		Normal	Oracle Clusterware Synchronization Management process is running normally.
			Warning	Monitoring is suspended on a server.
			Error	Oracle Clusterware Synchronization Management process has an error.
			Dummy Failure	Dummy failure is enabled.
			Unknown	No information is acquired.
(66)	AWS elastic ip monitor resource		Normal	The AWS elastic ip monitor resource is running normally.
			Warning	The AWS elastic ip monitor resource has one or more servers on which monitoring is suspended.
			Error	The AWS elastic ip monitor resource has an error.
			Dummy Failure	Dummy failure is enabled.
			Unknown	No information is acquired.
(67)	AWS virtual ip monitor resource		Normal	The AWS virtual ip monitor resource is running normally.
			Warning	The AWS virtual ip monitor resource has one or more servers on which monitoring is suspended.
			Error	The AWS virtual ip monitor resource has an error.
			Dummy Failure	Dummy failure is enabled.
			Unknown	No information is acquired.
(68)	AWS AZ monitor resource		Normal	The AWS AZ monitor resource is running normally.
			Warning	One or more AWS AZ monitor resources have an error, or monitoring is suspended on a server.
			Error	The AWS AZ monitor resource has an error.

No.	Icon	Status	Description
		Dummy Failure	Dummy failure is enabled.
		Unknown	No information is acquired.
(69)		Normal	The Azure probe port monitor resource is running normally.
		Warning	The Azure probe port monitor resource has a monitoring suspended on a server.
		Error	The Azure probe port monitor resource has an error.
		Dummy Failure	Dummy failure is enabled.
		Unknown	No information is acquired.
(70)		Normal	The Azure load balance monitor resource is running normally.
		Warning	The Azure load balance monitor resource has a monitoring suspended on a server.
		Error	The Azure load balance monitor resource has an error.
		Dummy Failure	Dummy failure is enabled.
		Unknown	No information is acquired.

## Operations from the WebManager

You can operate a cluster by right-clicking (1) Cluster, (3) Individual server, (12) Individual group, or (21) VM resource and choosing an operation.

### Objects of the cluster

When you right-click the **cluster** object, the following shortcut menu is displayed.

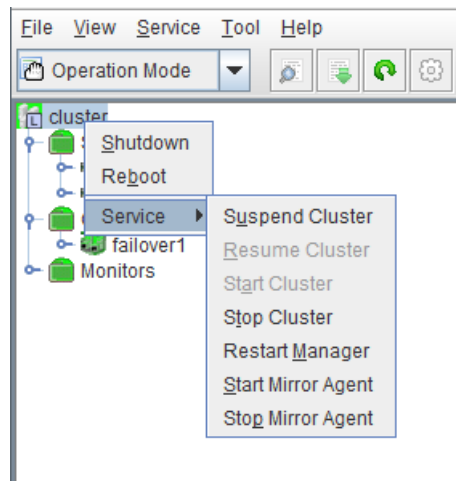

#### ◆ Shut down

Shuts down all running servers. When you select **Shutdown**, the following dialog box is displayed for confirmation.

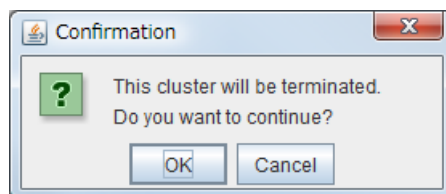

Note that servers that cannot be accessed from the server to which the WebManager is connected (for example, servers that all LAN heartbeat resources are stopped) will not be shut down.

#### ◆ Reboot

Reboots all running servers. When you select **Reboot**, the following dialog box is displayed for confirmation.

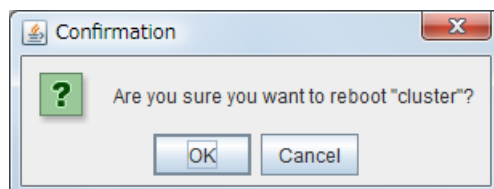

◆ Service

Clicking **Service** displays **Suspend Cluster**, **Resume Cluster**, **Start Cluster**, **Stop Cluster**, **Start Mirror Agent** and **Stop Mirror Agent**.

### Servers object

When you right-click the **servers** object, the following shortcut menu is displayed.

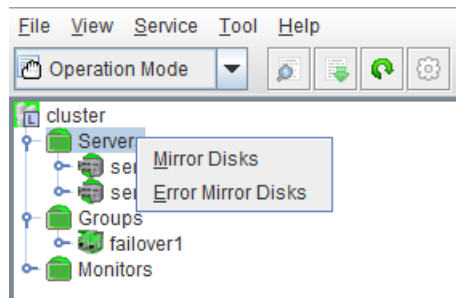

- ◆ **Mirror Disks**

If you select this menu, the following dialog box that all the mirror disk resources and hybrid disk resources are listed is displayed.

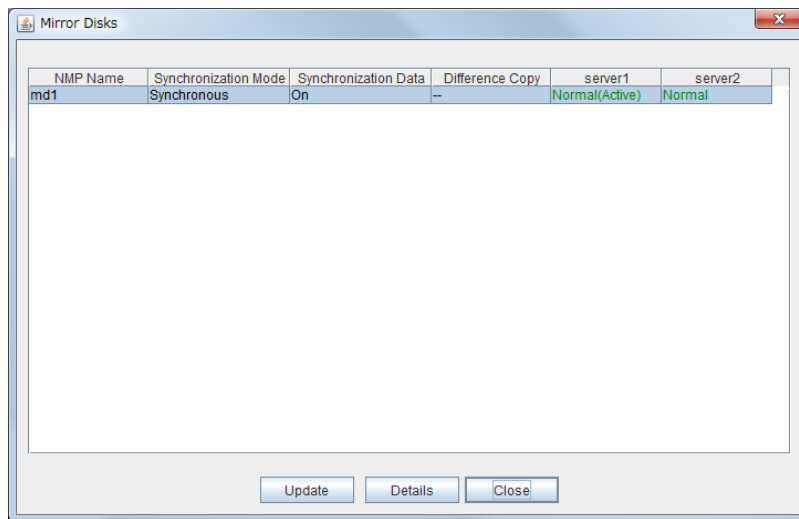

- **Details**

Starts the **Mirror Disk Helper** dialog box for the selected mirror disk resource or hybrid disk resource.

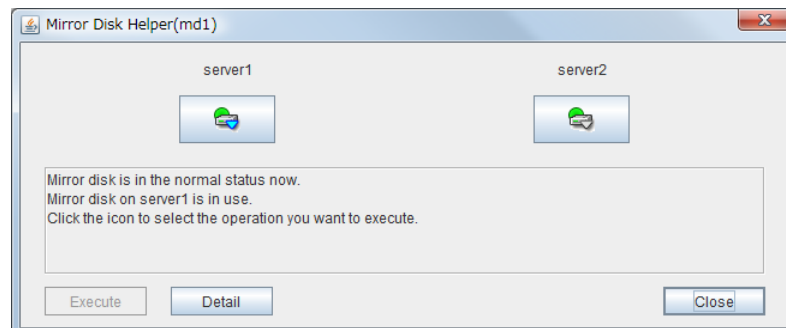

For information on using the Mirror Disk Helper, see "Mirror disk helper" on page 89.



◆ Error Mirror Disks

Lists mirror disk resources and hybrid disk resources with an error in a dialog box.

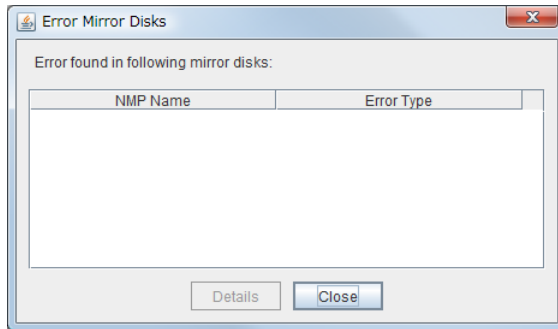

If there is any mirror disk or hybrid disk with an error listed below in the cluster, the above dialog box will be displayed.

The description provides what you should do to correct an error on the mirror disk or hybrid disk.

Error type	Description
Mirror Error	Mirror recovery or forced mirror recovery is necessary. Run the Mirror Helper and perform mirror recovery.  If a communication status error occurs during mirror disk connect, check the communication status.
Mirror Error (Single Server Run)	Only one server is running, and the latest data of a mirror disk/hybrid disk is not completed. To continue the operation, run the Mirror Helper and execute mirror recovery. Be careful since the server that is currently running will be the latest data when the mirror recovery is executed.

When you select **Details**, the Mirror Disk Helper is activated.

### Individual server objects

When you right-click an individual server object, the following shortcut menu is displayed.

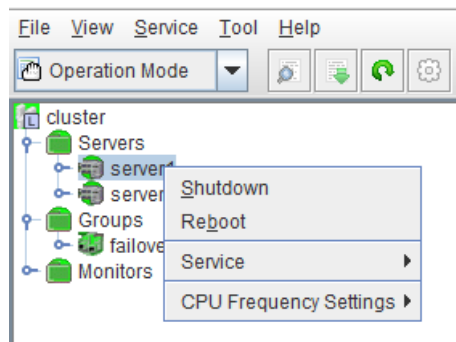

◆ Shut down

Shuts down the selected server. When you select this operation, the following dialog box is displayed for confirmation.

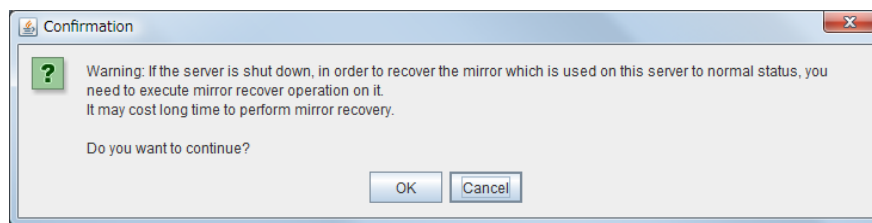

◆ Reboot

Reboots the selected server. When you select this operation, the following dialog box is displayed for confirmation.

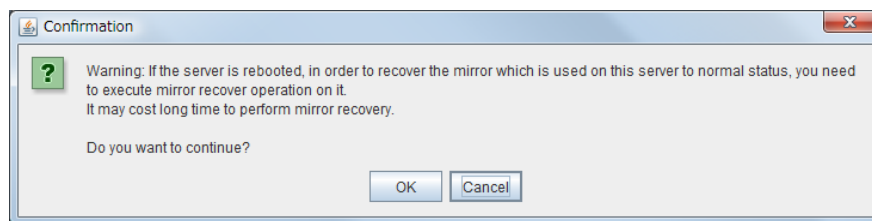

◆ Service

When you click **Start on Service**, the selected server is started. When you select this operation, the following dialog box is displayed for confirmation.

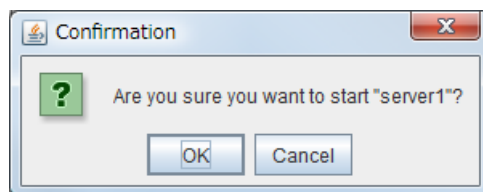

When you click **Stop** on **Service**, the selected server is stopped. When you select this operation, the following dialog box is displayed for confirmation.

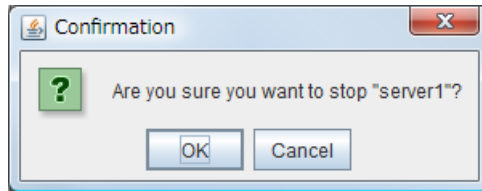

◆ CPU Frequency Settings

Configures the CPU frequency control function of the selected server.

- Highest Frequency  
Sets the CPU frequency to high.

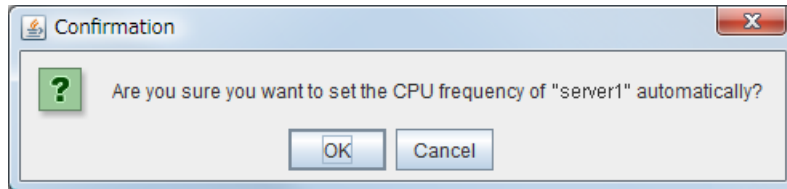

- Low Frequency  
Lowers the frequency to turn it to power-saving mode.

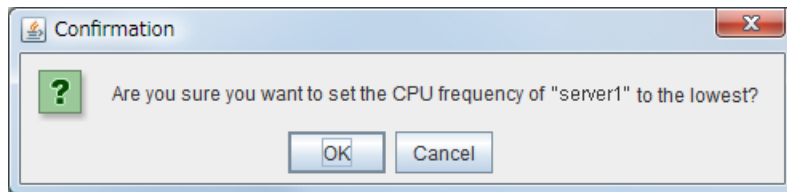

- Auto  
Restores the CPU frequency control to the control by EXPRESSCLUSTER.

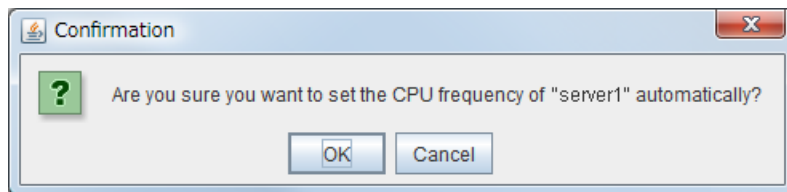

This function cannot be used when the checkbox of "Use CPU Frequency Control" is not selected in the power saving settings in cluster properties.

### Individual failover group objects

When you right-click an individual group object, the following shortcut menu is displayed.

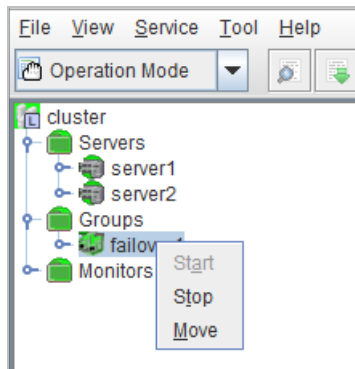

- ◆ Start (enabled only when the group is stopped)

Starts up the selected group. The dialog box for choosing a server that starts up the selected group is displayed.

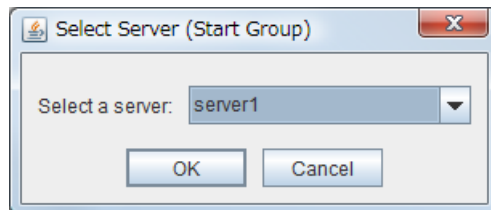

- ◆ Stop (enabled only when the group has been started up or when it has an error)

Stops the selected group. When you select this operation, the following dialog box is displayed for confirmation.

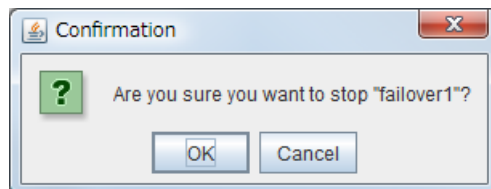

- ◆ Move (enabled only when the group has been started up)

Moves the selected group. The dialog box for choosing a server to which you want to move the selected group is displayed. The status of the group resource of moved group is kept.

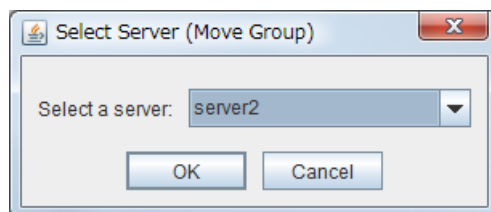

### Objects of the individual VM group

When you right-click a virtual machine group object, the following shortcut menu is displayed.

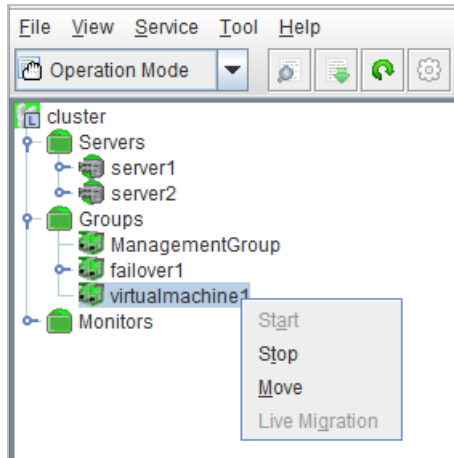

- ◆ Start (enabled only when the group is stopped)

Starts up the selected group. The dialog box for selecting the server that starts up the selected group is displayed.

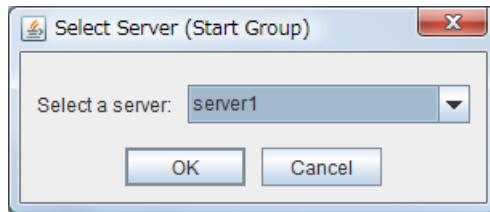

- ◆ Stop (enabled only when the group is running or has an error)

Stops the selected group. When you select this operation, the following confirmation dialog box is displayed.

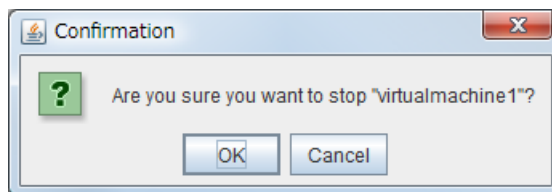

- ◆ Move (enabled only when the group has been started up)

Moves the selected group. The dialog box for selecting the server to which to move the selected group is displayed.

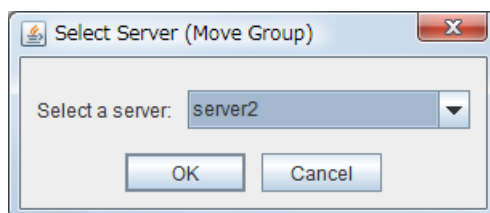

- ◆ Live Migration (enabled only when the group has been started up)

Migrates the selected group. The dialog box for selecting the server to which to migrate the selected group is displayed.

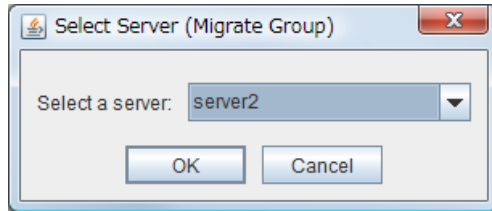

On the server selection screen, servers where groups can be started can be selected as the destination (except the active server and offline servers).

**Individual group resource objects (except mirror disk resources, hybrid disk resources, and VM resources)**

When you right-click an individual group resource object, the following shortcut menu is displayed.

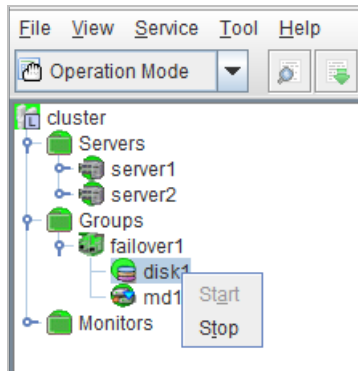

- ◆ Start (enabled only when the group is stopped)

Starts up the selected group resource.

The dialog box for selecting the server that starts up the selected group is displayed.

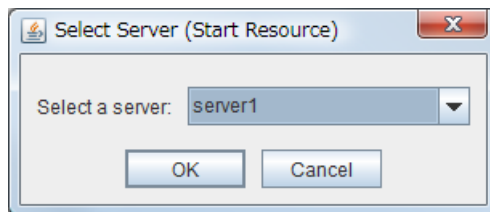

- ◆ Stop (enabled only when the group is running or it has an error)

Stops the selected group. When you select this operation, the following dialog box for confirmation is displayed.

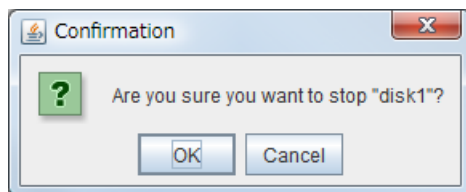

**Mirror disk resource object and hybrid disk resource object**

When you right-click a mirror disk resource object, the following shortcut menu is displayed.

For the start or stop methods, refer to “Individual group resource objects (except mirror disk resources, hybrid disk resources, and VM resources)”.

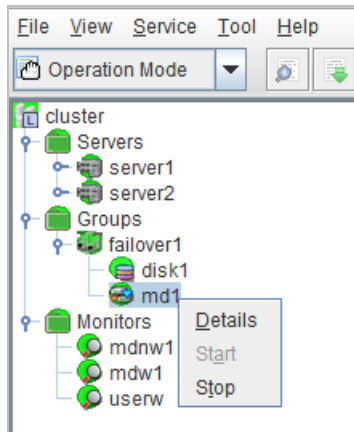

◆ Details

Starts up the Mirror Disk Helper for the selected mirror disk resource or hybrid disk resource, and the following dialog box for the Mirror Disk Helper is displayed.

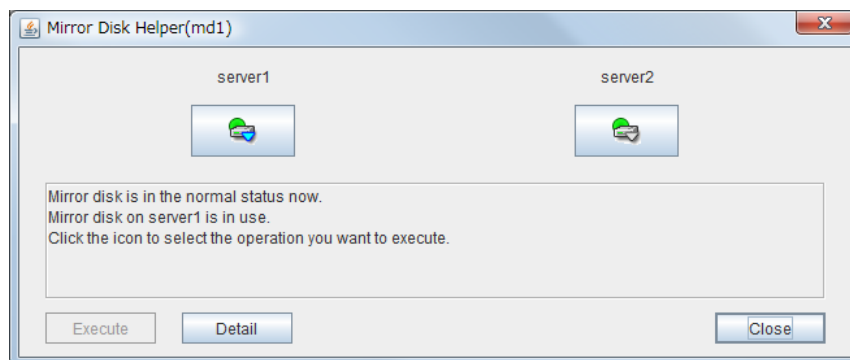

For information on using the Mirror Disk Helper, see “Mirror disk helper.”



### Monitors object

When you right-click the **Monitors** object, the following shortcut menu is displayed.

When operation mode is selected

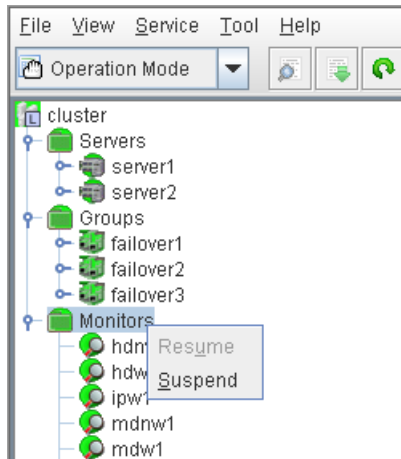

When verification mode is selected

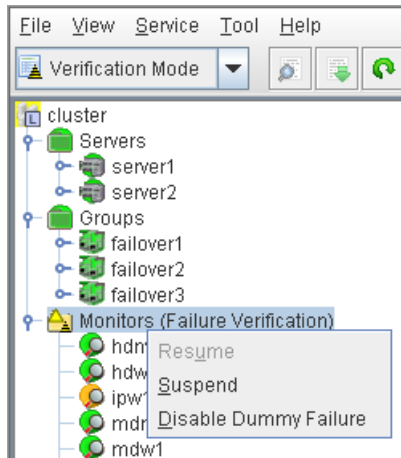

- ◆ Resume (enabled only when the monitor is suspended)

Resumes all the monitor resources that are configured. This operation is not performed on the monitor resources where suspending/resuming the monitoring is not possible. The following dialog box for selecting the server where monitor resources are resumed is displayed.

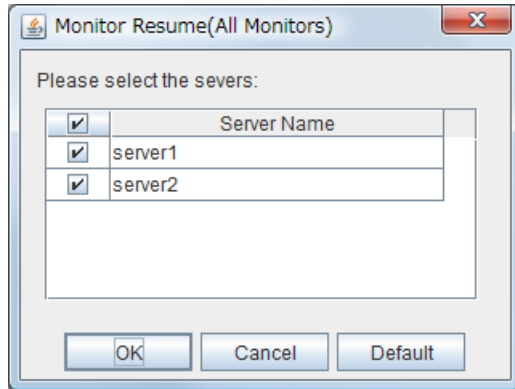

- ◆ Suspend (enabled only when the monitor is running)

Suspends all the monitor resources that are configured. This operation is not performed on the monitor resources where suspending/resuming the monitoring is not possible. The following dialog box for selecting the server where monitor resources are suspended is displayed.

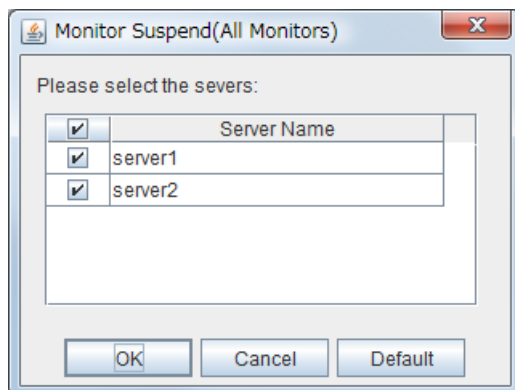

- ◆ Disable Dummy Failure (available only when dummy failure is enabled)

Disable dummy failure for all monitor resources. Select the server on which dummy failure for monitor resources is to cleared from the dialog box shown below.

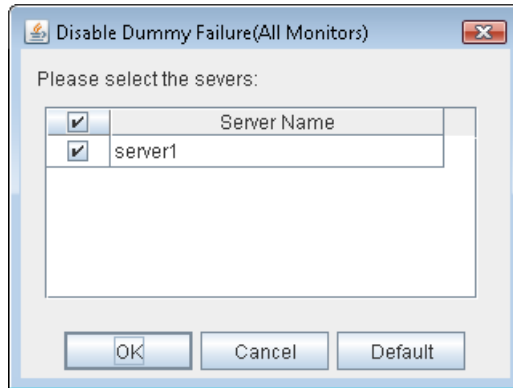

### Individual monitor resource objects

When you right-click an individual monitor resource object, the following shortcut menu is displayed.

When operation mode is selected

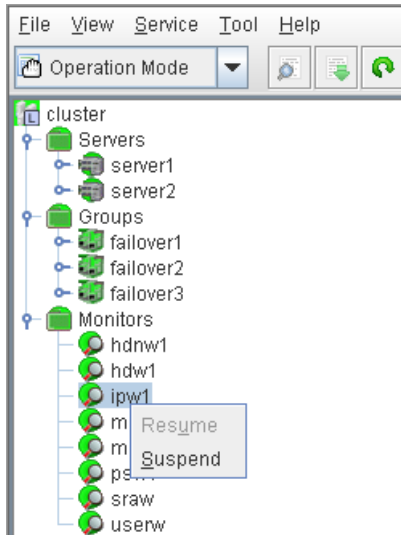

When verification mode is selected

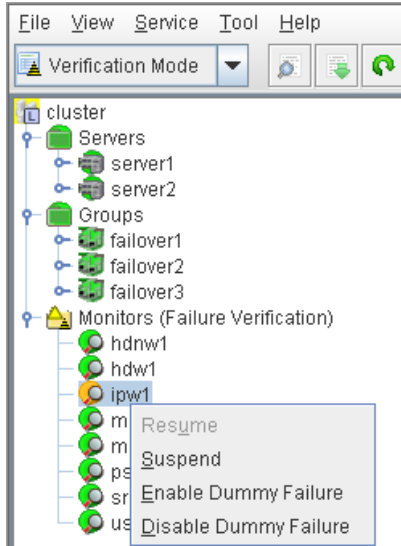

- ◆ Resume (enabled only when the monitor is suspended)

Resumes a selected monitor resource. This operation is not performed on the monitor resources where suspending/resuming the monitoring is not possible. The following dialog box for selecting the server where a selected monitor resource is resumed is displayed.

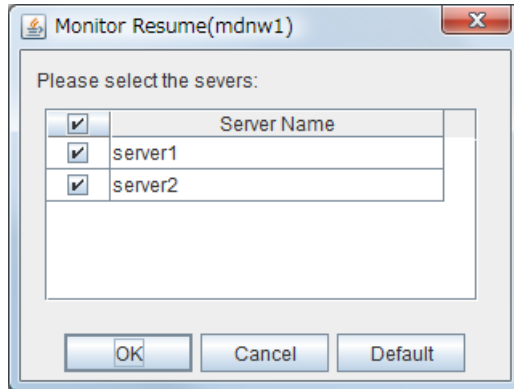

- ◆ Suspend (enabled only when the monitor is running)

Suspends a selected monitor resource. This operation is not performed on the monitor resources where suspending/resuming the monitoring is not possible. The following dialog box for selecting the server where a selected monitor resource is suspended is displayed.

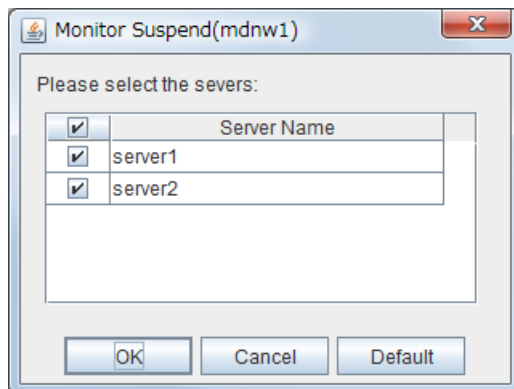

◆ Enable Dummy Failure (available only in verification mode)

Enable dummy failure for a selected monitor resource. Dummy failure can be enabled only on a server on which **Resource Status on Each Server** of the relevant monitor resource indicates a status other than **Error** or **Dummy Failure**.

Note, however, that the following monitor resources cannot be selected:

- Mirror disk connect monitor resources
- Mirror disk monitor resources
- Hybrid disk connect monitor resources
- Hybrid disk monitor resources
- User-mode monitor resources
- Virtual IP monitor resources
- ARP monitor resources
- External coordination monitor resources
- Dynamic DNS monitor resources
- VM monitor resource

Select the server on which to enable dummy failure for the selected monitor resource from the following dialog box.

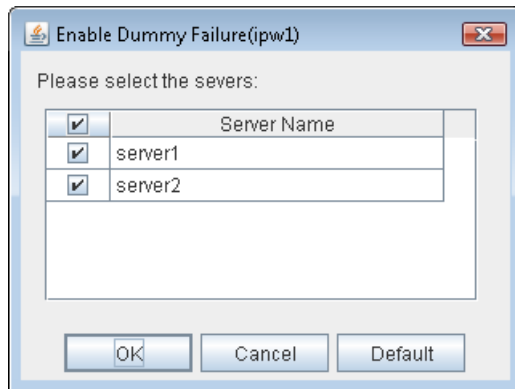

---

**Note:** When an attempt is made to enable dummy failure, and if one or more servers cannot be connected, an error is displayed. Dummy failure cannot be enabled on a server that cannot be connected.

---

- ◆ Disable Dummy Failure (available only in verification mode)

Dummy failure is disabled for the selected monitor resource. Select the server on which the dummy failure is to be disabled for the selected monitor resource from the dialog box shown below.

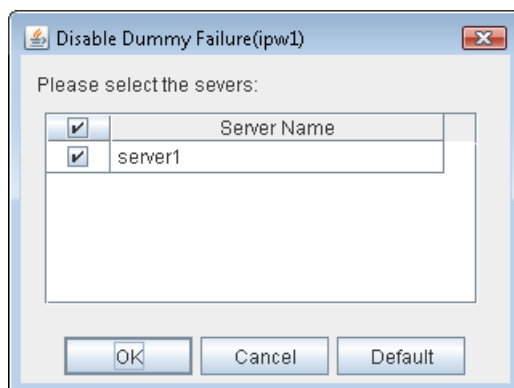

## Checking the cluster status by the WebManager list view

The detailed information on the selected object in the tree view of WebManager can be displayed.

### To display information on the whole cluster

1. Start the WebManager.
2. In this tree view, click the object icon  for the cluster. In the list view in the right pane of the window, the **group status** and **monitor resource status** of each server are displayed.

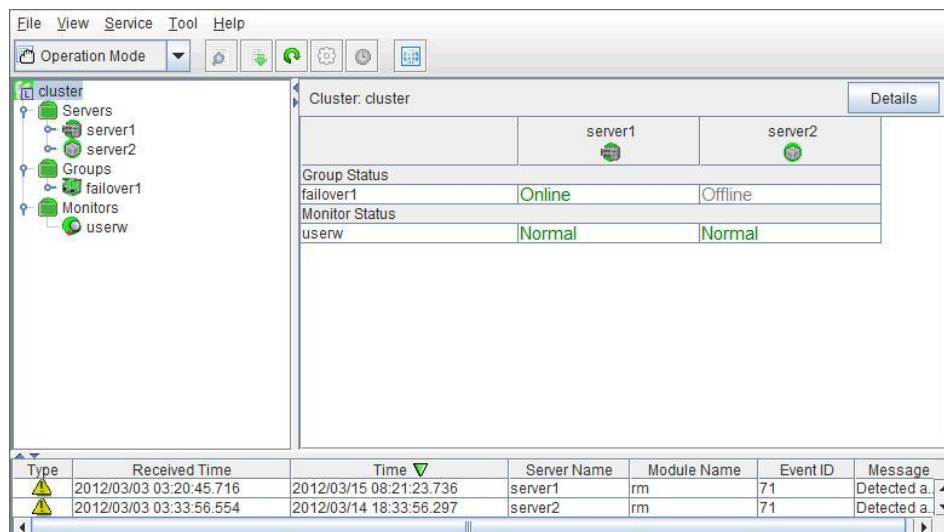

3. In the following dialog box, click **Details** to display the following information.

Properties		Value
Name	cluster	
Comment		
Status	Normal	

**Name:** Cluster name  
**Comment:** Comment for the cluster  
**Status:** Status of the cluster

Properties		Value
Server Down Notification	On	

**Server Down Notification** Server down notification

Properties		Value
Action at NP Occurrence	Stop the cluster service and shutdown OS	

**Action at NP Occurrence** Action to be taken when a network partition occurs



## Checking the cluster status by the WebManager list view

Alert Service	Delay Warning	Exclusion	Mirror Agent	Mirror Driver	Power Saving	JVM monitor		
Info	Heartbeat I/F	NP Resolution	Timeout	Port No.	Port No.(Mirror)	Port No.(Log)	Monitor	Recovery
Properties				Value				
Server Sync Wait Time (sec)				300				
Heartbeat Timeout (msec)				90000				
Heartbeat Interval (msec)				3000				
Server Internal Timeout (sec)				180				
Timeout Ratio				1				

**Server Sync Wait Time (sec):** Time to wait for the other servers to start up (in seconds)

**Heartbeat Timeout (msec):** Heartbeat time-out (in milliseconds)

**Heartbeat Interval (msec):** The interval for sending heartbeats (in milliseconds)

**Server Internal Timeout (sec):** Internal communication time-out (in seconds)

**Timeout Ratio:** Current time-out ratio

Alert Service	Delay Warning	Exclusion	Mirror Agent	Mirror Driver	Power Saving	JVM monitor		
Info	Heartbeat I/F	NP Resolution	Timeout	Port No.	Port No.(Mirror)	Port No.(Log)	Monitor	Recovery
Properties				Value				
Server Internal Port Number				29001				
Data Transfer Port Number				29002				
Heartbeat Port Number				29002				
Kernel Mode Heartbeat Port Number				29006				
WebManager HTTP Port Number				29003				
Alert Sync Port Number				29003				

**Server Internal Port Number:** Port number for internal communication

**Data Transfer Port Number:** Port number for data transfer

**Heartbeat Port Number:** Port number for heartbeat

**Kernel Mode Heartbeat Port Number:** Port number for kernel-mode heartbeat

**WebManager HTTP Port Number:** Port number for WebManager

**Alert Sync Port Number:** Port number for alert synchronization

Alert Service	Delay Warning	Exclusion	Mirror Agent	Mirror Driver	Power Saving	JVM monitor		
Info	Heartbeat I/F	NP Resolution	Timeout	Port No.	Port No.(Mirror)	Port No.(Log)	Monitor	Recovery
Properties				Value				
Communication Method for Internal Logs				UNIX Domain				
Port Number				0				

**Communication method for Internal Logs:**

Communication method used for logs

**Port Number:**

Port number used for logs

Alert Service	Delay Warning	Exclusion	Mirror Agent	Mirror Driver	Power Saving	JVM monitor		
Info	Heartbeat I/F	NP Resolution	Timeout	Port No.	Port No.(Mirror)	Port No.(Log)	Monitor	Recovery
Properties				Value				
Shutdown Monitor				Always execute				
Shutdown Monitoring Method				softdog				
Action				RESET				
Enable SIGTERM Handler				Off				
Use HB Timeout				On				
Timeout (sec)				90				
Collect System Resource Information				Off				

**Shutdown Monitor:** Whether or not to monitor shutdown

**Shutdown Monitoring Method:** Method for monitoring shutdown

**Action:** Operation at time-out

**Enable SIGTERM Handler:** Whether or not to enable SIGTERM

**Use HB Timeout:** Whether or not to use HB time-out

**Timeout (sec):** Timeout (in seconds)

**Collect System Resource Information:** Whether or not to collect System Resource Information

Monitor	Recovery	Alert Service	Delay Warning	Exclusion	Mirror Agent	Mirror Driver	Power Saving	JVM monitor
Info	Heartbeat I/F	NP Resolution	Timeout	Port No.	Port No.(Mirror)	Port No.(Log)	Monitor	Recovery
Properties							Value	
Max Reboot Count							0	
Max Reboot Count Reset Time (min)							0	
Use Forced Stop							Off	
Forced Stop Action							BMC Reset	
Forced Stop Timeout (sec)							3	
Execute Script for Forced Stop							Off	
Action When the Cluster Service Process Is Failure							Shut down the OS	
Recovery Action for HA Agents: Max Restart Count							3	
Recovery Action for HA Agents: Recovery Action over Max Restart Count							No operation	
Start Automatically After System Down							On	
Disable Recovery Action Caused by Monitor Resource Failure							Off	
Action at Group Resource Activation or Deactivation Stall							Stop the cluster service and shutdown OS	
Restrain the shutdown action if only one server is alive (when active group resource abnormality detected)							Off	
Restrain the shutdown action if only one server is alive (when deactive group resource abnormality detected)							Off	
Restrain the shutdown action if only one server is alive (when monitoring resource abnormality detected)							Off	

- Max Reboot Count:** Maximum reboot count
- Max Reboot Count Reset Time (min):** Maximum reboot count reset time (in minutes)
- Use forced stop:** Whether or not to use a forced stop function
- Max Reboot Count:** Maximum reboot count
- Forced stop timeout (sec):** Wait time till the activation of failover group is started after a forced stop function is performed (in seconds)
- Execute Script for Forced Stop** Whether to execute a script for forced stop
- Action When the Cluster Service Process Is Failure** Action to be taken when a cluster service process fails
- Recovery Action for HA Agents: Max Restart Count** Maximum count to restart an HA process if the process fails
- Recovery Action for HA Agents: Recovery Action over Max Restart Count** Action to be taken when the HA process fails and the process cannot be restarted even after retrying restart of the process for the maximum number of retries
- Start Automatically After System Down:** Whether or not to prohibit automatic startup of the cluster service when it is stopped abnormally
- Disable Recovery Action Caused by Monitor Resource Failure** Whether or not to disable the recovery action when the monitor resource fails
- Action at Group Resource Activation or Deactivation Stall** Action to be taken when group resource activation/deactivation is stalled
- When active group resource abnormality detected:** Whether or not to disable shutdown at activation failure in the case of the last one server
- When non active group resource abnormality detected:** Whether or not to disable shutdown at deactivation failure in the case of the last one server
- When monitoring resource abnormality detected:** Whether or not to disable shutdown at monitoring error in the case of the last one server

Alert Service	Delay Warning	Exclusion	Mirror Agent	Mirror Driver	Power Saving	JVM monitor		
Info	Heartbeat I/F	NP Resolution	Timeout	Port No.	Port No.(Mirror)	Port No.(Log)	Monitor	Recovery
Properties							Value	
E-mail Address								
Use Network Warning Light							Off	
Use Alert Extension							Off	
Use Chassis Identify							Off	
Enable Alert Setting							Off	

- E-mail Address:** Destination e-mail address for sending alerts
- Use Network Warning Light:** Whether or not to use a network warning light
- Use Alert Extension:** Whether or not to use an alert extension function
- Use Chassis Identify** Whether or not to use a chassis identify function
- Enable Alert Setting** Whether or not to use the alert setting

Checking the cluster status by the WebManager list view

Alert Service		Delay Warning	Exclusion	Mirror Agent	Mirror Driver	Power Saving	JVM monitor		
Info	Heartbeat I/F	NP Resolution	Timeout	Port No.	Port No.(Mirror)	Port No.(Log)	Monitor	Recovery	
Properties					Value				
Heartbeat Delay Warning					80				
Monitor Delay Warning					80				

Heartbeat Delay Warning: Heartbeat delay warning (%)  
 Monitor Delay Warning: Monitor delay warning (%)

Alert Service		Delay Warning	Exclusion	Mirror Agent	Mirror Driver	Power Saving	JVM monitor		
Info	Heartbeat I/F	NP Resolution	Timeout	Port No.	Port No.(Mirror)	Port No.(Log)	Monitor	Recovery	
Properties					Value				
Mount,Umount Exclusion					On				

Mount, Umount Exclusion: Whether or not to exclude a mount or unmount command

Alert Service		Delay Warning	Exclusion	Mirror Agent	Mirror Driver	Power Saving	JVM monitor		
Info	Heartbeat I/F	NP Resolution	Timeout	Port No.	Port No.(Mirror)	Port No.(Log)	Monitor	Recovery	
Properties					Value				
Use CPU Frequency Control					Off				

Use CPU Frequency Control: Whether or not to use CPU frequency control

Alert Service		Delay Warning	Exclusion	Mirror Agent	Mirror Driver	Power Saving	JVM monitor		
Info	Heartbeat I/F	NP Resolution	Timeout	Port No.	Port No.(Mirror)	Port No.(Log)	Monitor	Recovery	
Properties					Value				
Java Install Path									
Maximum Java Heap Size (MB)					7				
Load Balancer Connection Setting					Off				
Log Level					INFO				
Generation Count for Stored Log Files					10				
Log Rotation Type					File Size				
Log File Maximum Size (KB)					3072				
Time of First Log Rotation					00:00				
Log Rotation Interval (Hours)					24				
Resource Measurement: Retry Count					10				
Resource Measurement: Threshold for Abnormal Judgment					5				
Resource Measurement: Default Interval					60				
Resource Measurement: Interval for Full GC					120				
WebLogic Monitoring: Retry Count					3				
WebLogic Monitoring: Threshold for Abnormal Judgment					5				
WebLogic Monitoring: Request Count Measurement Interval					60				
WebLogic Monitoring: Interval for Average measurement					300				
Management Port					25500				
Connection Retry Count					3				
Time until Reconnect					60				
Management Port for Load Balancer Linkage					25550				
Health Check Linkage Function					Off				
Directory containing HTML files									
HTML File Name									
HTML Renamed File Name									
Retry count for renaming					3				
Wait time for retry					3				
Management IP Address									
Connection Port					443				

Java Install Path: Java installation path  
 Maximum Java Heap Size (MB): Maximum Java heap size (MB)  
 Load Balancer Linkage Settings: Load balancer linkage settings  
 Log Level: Log level  
 Generation Count for Stored Log Files: Number of generations of log files to be stored  
 Log Rotation Type: Log rotation type  
 Log File Maximum Size (KB): Maximum log file size (KB)  
 Time of First Log Rotation: Time of the first log rotation  
 Log Rotation Interval (Hours): Log rotation interval (hours)  
 Resource Measurement: Retry Count: Measurement retry count  
 Resource Measurement: Threshold for Abnormal Judgment: Threshold for abnormal judgment

- Resource Measurement: Default Interval:
  - Interval for memory and thread measurement (sec)
- Resource Measurement: The time and count in Full GC:
  - Interval for Full GC measurement (sec)
- WebLogic Monitoring: Retry Count:
  - Measurement retry count
- WebLogic Monitoring: Threshold for Abnormal Judgment:
  - Threshold for abnormal judgment
- WebLogic Monitoring: Request Count Measurement Interval:
  - Interval for measuring the number of requests (sec)
- WebLogic Monitoring: Interval for Average measurement:
  - Interval for measuring the average (sec)
- Management Port:
  - Management port number
- Connection Retry Count:
  - Connection retry count
- Time until Reconnect:
  - Time to wait for reconnection (sec)
- Management Port for Load Balancer Linkage:
  - Management port number for load balancer linkage
- Health Check Linkage Function:
  - Whether or not to use the health check linkage function
- HTML Path:
  - HTML storage directory
- HTML File Name:
  - HTML file name
- HTML Renamed File Name:
  - Renamed HTML file name
- Retry Count:
  - Retry count if renaming fails
- Retry Interval:
  - Time to wait for a renaming retry (sec)
- Management IP address:
  - BIG-IP LTM management IP address
- Connection Port:
  - Communication port number for BIG-IP LTM

**When Replicator and/or Replicator DR are used:**

Only the information which is different from that of EXPRESSCLUSTER X (above) is described below.

Alert Service	Delay Warning	Exclusion	Mirror Agent	Mirror Driver	Power Saving	JVM monitor		
Info	Heartbeat I/F	NP Resolution	Timeout	Port No.	Port No.(Mirror)	Port No.(Log)	Monitor	Recovery
Properties				Value				
Mirror Agent Port Number				29004				

**Mirror Agent Port Number:** Port number used by a mirror agent

Alert Service	Delay Warning	Exclusion	Mirror Agent	Mirror Driver	Power Saving	JVM monitor		
Info	Heartbeat I/F	NP Resolution	Timeout	Port No.	Port No.(Mirror)	Port No.(Log)	Monitor	Recovery
Properties				Value				
Auto Mirror Recovery				On				
Collect Mirror Statistics				On				
Receive Timeout (sec)				10				
Send Timeout (sec)				120				
Recovery Data Size (kbyte)				4096				
Recovery Retry Count				0				
Start Wait Time (sec)				10				
Cluster Partition I/O Timeout (sec)				30				

- Auto Mirror Recovery:
  - Whether or not to perform auto mirror recovery
- Collect Mirror Statistics:
  - Whether or not to collect mirror statistics
- Receive Timeout (sec):
  - Receive time-out (in seconds)
- Send Timeout (sec):
  - Send time-out (in seconds)
- Recovery Data Size (kbyte):
  - Recovery data size (in kilobytes)
- Recovery Retry Count:
  - Recovery retry count
- Start Wait Time (sec):
  - Wait time for starts of servers in a server group. (sec)
- Cluster Partition I/O Timeout (sec) :
  - I/O timeout (sec) of the cluster partition

## Checking the cluster status by the WebManager list view

Alert Service		Delay Warning		Exclusion		Mirror Agent		Mirror Driver		Power Saving		JVM monitor			
Info	Heartbeat I/F	NP Resolution	Timeout	Port No.	Port No.(Mirror)	Port No.(Log)	Monitor	Recovery							
Properties								Value							
Request Queue Maximum Number								2048							
Bitmap Update Interval (sec)								100							
Cluster Partition								RESET							
Data Partition								RESET							

**Request Queue Maximum Number:**

Maximum number of request queues

**Bitmap Update Interval (sec):**

Interval for updating bitmap (in seconds)

**Cluster Partition:**

Action to be taken when an I/O error occurs in a cluster partition.

**Data Partition:**

Action to be taken when an I/O error occurs in a data partition.

## Checking the whole status of the server in the WebManager list view

1. Start the WebManager.
2. In the top section of the right window pane, the heartbeat status and the network partition resolution status list on each server are displayed.

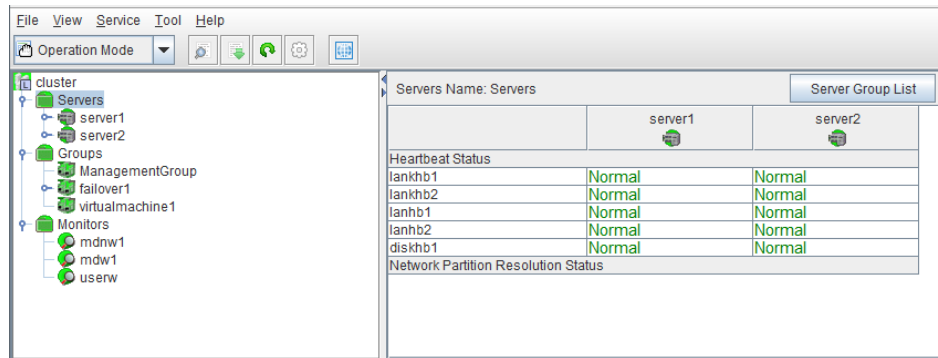

Additionally, click **Server Group List** to display the information of the server group on the pop up dialog.

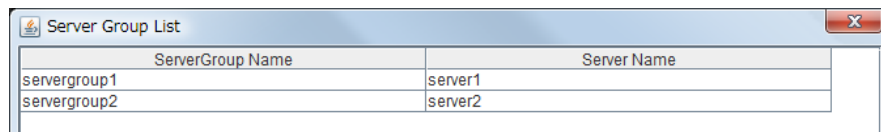

## Checking the status of individual server in the WebManager list view

1. Start the WebManager.
2. In the tree view, select the object of an individual server . The **Server Comment**, **Product**, **Version**, **Platform**, **Status** of the server are displayed.

Server Name: server1		Details
Properties	Value	
Comment		
Virtual Infrastructure		
Product	EXPRESSCLUSTER X 3.3 for Linux	
Version	3.3.0-1	
Platform	Red Hat Enterprise Linux Server release 6.5 (Santiago)	
Status	Online	
Heartbeat Status		
lankhb1	Normal	
lankhb2	Normal	
lankhb3	Normal	
Network Partition Resolution Status		

Comment:	Comment for the server
Virtual Infrastructure	Virtual infrastructure name
Product:	Product name
Version:	Version (identical to the RPM version value)
Platform	Platform
Status:	Status of the server

When you click **Details**, the following information is displayed.

Properties	Value
Name	server1
Edition	X
Mirror Disk Connect IP Address mdc[1]	192.168.0.1
Network Warning Light IP Address(Type)	
Disk I/O Lockout Device	
BMC IP Address	
CPU Frequency Status	-
No shutdown when double activation detected	Off

Name:	Server name
Edition:	Edition
Mirror Disk Connect IP Address mdc[1] <sup>3</sup> :	IP address of mirror disk connect
Network Warning Light IP Address:	IP address of network warning light
Disk I/O Lockout Device:	Name of disk device which locks disk IO
BMC IP Address:	IP address of BMC
CPU Frequency Status:	Current setting status of CPU frequency control
No shutdown when double activation detected:	Whether or not to disable shutdown when activation of both disks is detected

<sup>3</sup> The number in brackets represents the mirror disk connect I/F number.

## Checking the status of the whole monitor in the WebManager list view

1. Start the WebManager.
2. In the tree view, select the object icon . The **Monitor Name** and the list of statuses on each server are displayed in the list view.



## Checking alerts using the WebManager

You can view alerts in the bottom part of the WebManager.

Each field of the alert view is configured as follows.

Receive Time	Time	Server Name	Module Name	Event ID	Message
2005/09/14 11:11:08.123	2005/09/14 11:11:06.367	server1	rm	26	Status of mdw1 changed normally.
2005/09/14 11:11:03.197	2005/09/14 11:11:02.962	server1	rm	26	Status of mdw1 changed normally.
2005/09/14 11:11:04.327	2005/09/14 11:11:01.857	server1	rm	26	Status of mdw2 changed normally.
2005/09/14 11:10:59.204	2005/09/14 11:10:58.917	server1	nm	3	Resource lanhb2 of server server2 up.
2005/09/14 11:11:01.680	2005/09/14 11:10:58.917	server1	nm	3	Resource comhb1 of server server2 up.
2005/09/14 11:11:01.607	2005/09/14 11:10:58.917	server1	nm	3	Resource lanhb1 of server server2 up.
2005/09/14 11:10:59.844	2005/09/14 11:10:57.460	server1	mdadmn	6	Building of switch mirror disk has finished successfully.(Device: md2)
2005/09/14 11:10:59.394	2005/09/14 11:10:56.902	server1	nm	3	Resource lankhb2 of server server2 up.
2005/09/14 11:10:57.139	2005/09/14 11:10:56.902	server1	nm	1	Server server2 up.
2005/09/14 11:10:59.283	2005/09/14 11:10:56.902	server1	nm	3	Resource lankhb1 of server server2 up.
2005/09/14 11:10:57.024	2005/09/14 11:10:56.807	server1	mdadmn	6	Building of switch mirror disk has finished successfully.(Device: md1)
2005/09/14 11:10:52.258	2005/09/14 11:10:53.485	server1	mdw	7	Recovery mode is FAST mode.(Device: md1)
2005/09/14 11:10:53.007	2005/09/14 11:10:51.593	server1	mdw	7	Recovery mode is FAST mode.(Device: md2)
2005/09/14 11:10:51.713	2005/09/14 11:10:51.577	server1	mdw	17	Recovery started.(Device: md2)
2005/09/14 11:10:51.130	2005/09/14 11:10:50.838	server1	mdw	17	Recovery started.(Device: md1)
2005/09/14 11:09:57.655	2005/09/14 11:09:57.317	server1	rm	1	Monitor pidw2 start.

For meanings of alert messages, see Chapter 11, "Error messages." For information about searching for alert messages, see "Searching for an alert by using the WebManager" on page 32 in this chapter.

### Alert view fields

The meaning of each of the fields in the alert view of the WebManager are the following.

- (1) Alert type icon

Alert type	Description
	Informational message
	Warning message
	Error message

- (2) Alert received time

The time the alert was received. The time in the server to which the WebManager connects is applied.

- (3) Alert sent time

The time the alert was sent from a server. The time in the alert sender server is used.

- (4) Alert sender server

The name of a server that sent the alert.

- (5) Alert sender module

The type of a module that sent the alert.

For a list of module name types, see "Searching for an alert by using the WebManager" on page 32 in this chapter.

(6) Event ID

The event ID number set to each alert.

(7) Alert message



The alert messages.

## Alert view operation

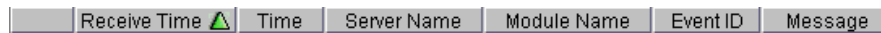
By clicking an item on the bar showing name of each field, you can change the alert order.



Whenever you select an item, the  or  mark is displayed in each field.

Mark	Purpose
	Sorts alerts in the ascending order of the selected field.
	Sorts alerts in the descending order of the selected field.

By default, alerts are displayed in the **Time** descending order.

When you right-click this bar, the following pop-up window is displayed so that you can select the items to be displayed. All items are selected by default.

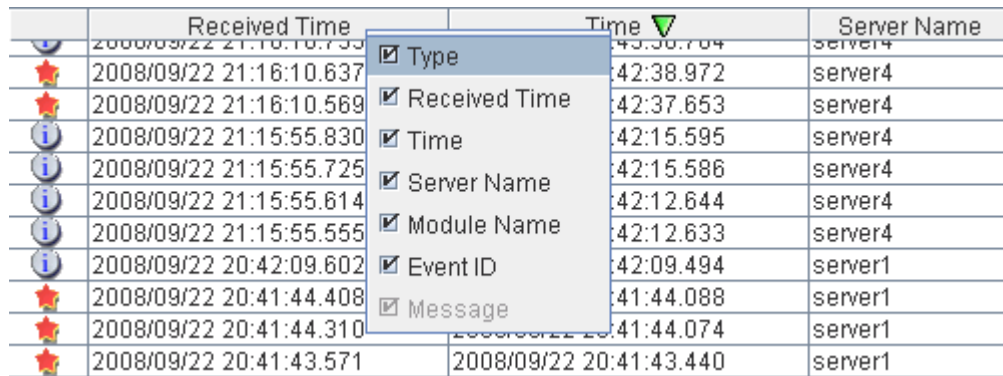

When you double-click the displayed alert, the following window is displayed where you can check the detail of the alert.

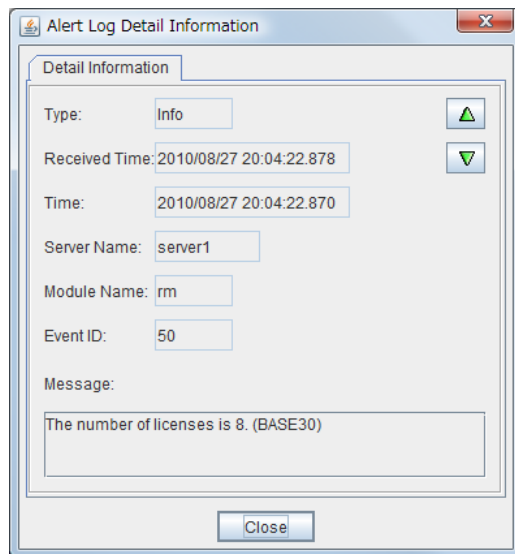

When you right-click the alert, the following pop-up window is displayed where you can select the type of the alert to be displayed. All items are selected by default.

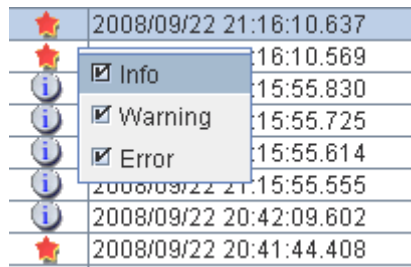

# Mirror disk helper

## Overview of the mirror disk helper

The Mirror Disk Helper is a tool to help recovery process of mirror disk/hybrid disk from the WebManager. The following shows the layout of the Mirror Disk Helper.

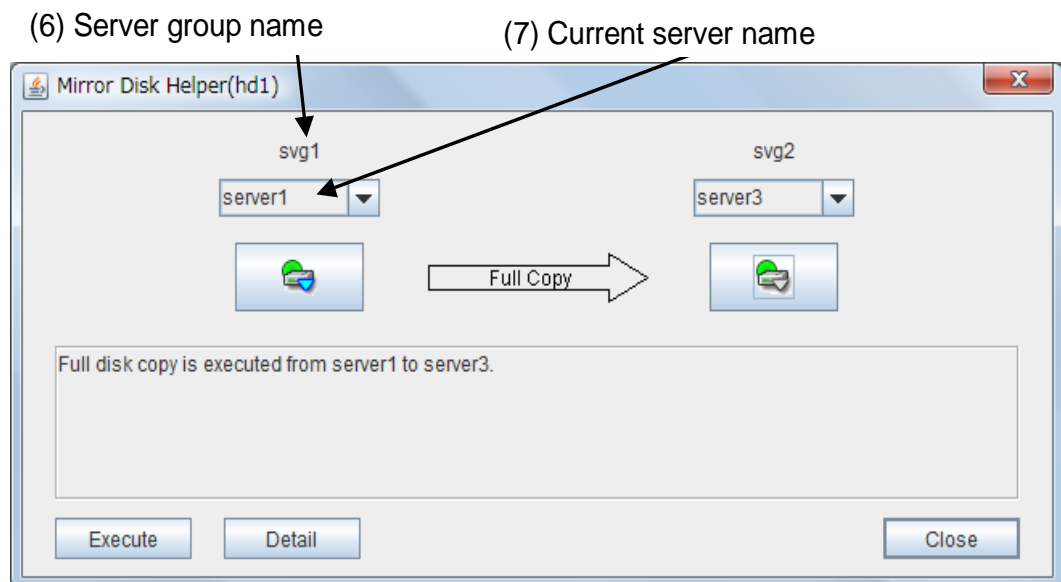
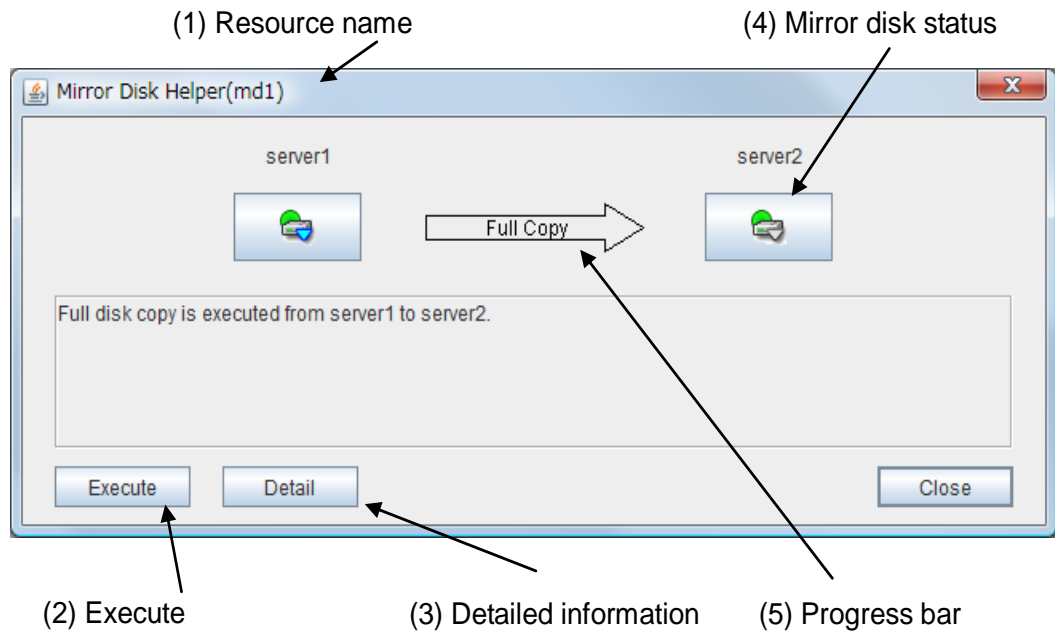

The Mirror Disk Helper can be started by the mirror disk list or mirror disk resource/hybrid disk resource of a group.

The following is the description of the each field of the Mirror Disk Helper.

(1) Resource name

Displays the name of a mirror disk resource/hybrid disk resource.

(2) Mirror recovery

You can perform various operations by clicking the mirror disk status icon. The **Execute** button is enabled when you select the operation. For the available operations, see "Operating Mirror Disk Helper" on page 93.

(3) Detailed information

When you click **Details**, detailed information is displayed.

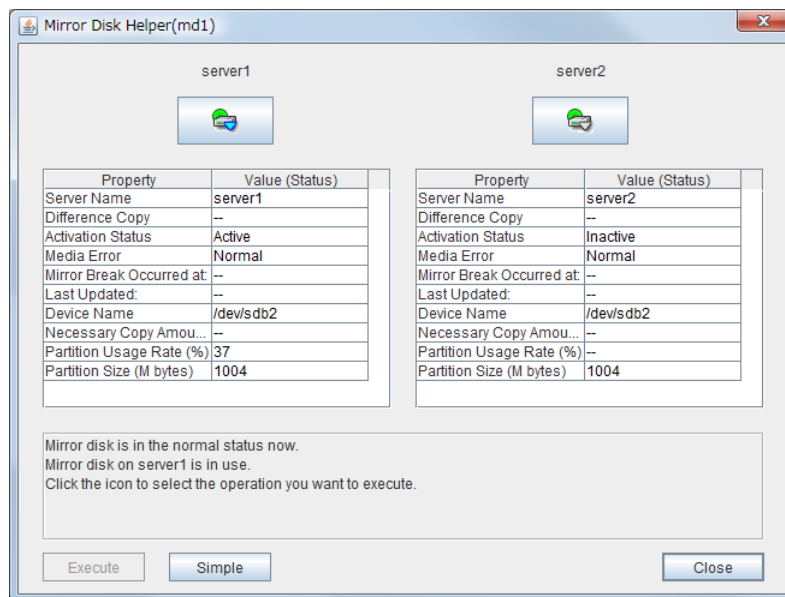

- Server Name: Server name
- Diff Status: Whether differential copying of the mirror disk device is possible
- Activation Status: Active status of the mirror disk device on the server
- Media Error: Media error of the mirror disk resource
- Mirror Break Occurred at: Error break time
- Last Update: The time that the data was updated the last time
- Device Name: The name of the mirror disk device
- Diff Percent: Amount of data that must be copied again to restart mirroring
- NMP Size (M bytes): NMP usage of each server's file system
- Disk Size (M bytes): Each server's NMP size











**Last Data Update Time** is displayed when only one of the servers is updated.

**Mirror Break Time** is displayed when mirror disks cannot be synchronized because mirror disk connect is disconnected.

If the size of the DP partition is different depending on a server, the smaller partition size is NMP Size.

## (4) Mirroring disk status

The following table shows the mirroring disk status of servers:

Icon	Mirroring disk status	Mirror color*
	Mirroring status of the server is normal. A mirror disk resource is inactive.	Green
	Mirroring status of the server is normal. A mirror disk resource is active. The server is in the normal mirroring status and has the latest data. It may not be synchronized with the other server.	Green
	Mirror recovery or forced mirror recovery is underway. A mirror disk resource is inactive.	Yellow
	Mirror recovery or forced mirror recovery is underway. A mirror disk resource is active.	Yellow
	The server has an error. Mirror recovery is required.	Red
	The server has an error. Limiting accesses to a mirror disk has been released.  (This also appears if a mirror disk resource is already active and it is not possible to automatically determine whether the server has the latest data because another server has started, for example, and if forced mirror recovery is required.)	Red
	Suspended. Determining the server with the latest data is suspended.	Orange
	The server is stopped or its status is unknown. Information on the server status cannot be acquired.	Gray
	Both systems are active.	Blue
	Cluster partition has an error.	Black

- To see the mirror color, run the `clpmdstat` or `clphdstat` command.

(5) Progress bar

When performing the mirror recovery or forced mirror recovery, the progress bar shows an arrow from a source server with the latest data to copy to the destination server.



How far the mirror recovery or forced mirror recovery has progressed and expected time required for copying are displayed in the progress bar.



(6) Server Group Name

Displays the name of server group.

(7) Current Server Name

Displays the name of current server. For information on the procedure for replacing the current server, see "Changing a current server (Only for hybrid disk resource)" on page 109.



## Operating Mirror Disk Helper

Available operations on the Mirror Disk Helper window differ depending on the mirror status of servers. Consider what you want to operate referring to this guide before starting the operation. The operation is executed by clicking **Execute** with the desired operation selected. The dialog boxes shown in this section are the ones taken from the mirror disk resource.

---

### Note:

Figures in the following description are simplified. Those differ from the actual Mirror Disk Helper screens.

The following description is for operating mirror disk status icon on server1. When operating the icon on server2, replace server1 with server2.

---

### (1) Operation available when server1 is normal

---

#### Note:

The following operation is available only when server1 is normal and mirror disk resource/hybrid disk resource is inactive. It cannot be performed on the server where any mirror disk resource/hybrid disk resource is activated normally.

---

1. When server2 is normal and mirror disk resources/hybrid disk resources are inactive

The following describes the operations which can be performed when mirror disk resources/hybrid disk resources are inactive on both servers. The figure on the upper left indicates the initial screen. Allows in the figure indicates transitions made when the mirror disk status icon of server1 is clicked.

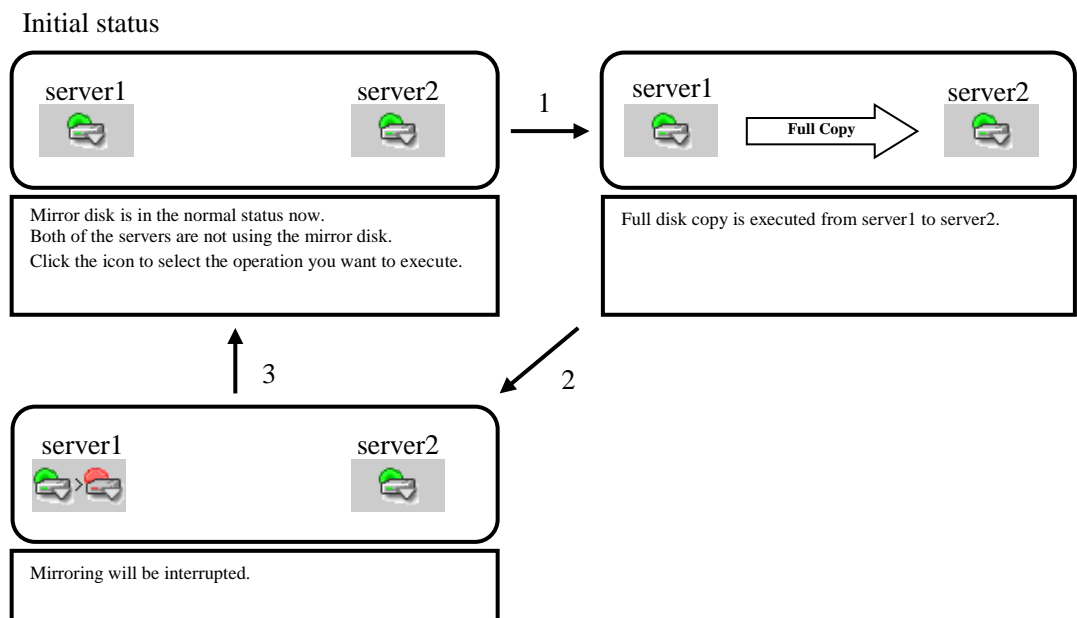

- A) Mirror recovery  
Recovers a mirror from server2 to server1. Full mirror recovery can be performed.
  - B) Mirror disk disconnection  
Disconnects a mirror disk of server1. Mirror synchronization is not performed when any mirror disk resource/hybrid disk resource is activated on server2.
  - C) Initialization  
Returns to the initial status. The current status is displayed.
2. When server2 is normal and any mirror disk resource/hybrid disk resource is active
- The following describes the operations which can be performed when any mirror disk resource/hybrid disk resource is active on server2. The figure on the upper left indicates the initial screen. Arrows in the figure indicates transitions made when the mirror disk status icon of server1 is clicked.

Initial status

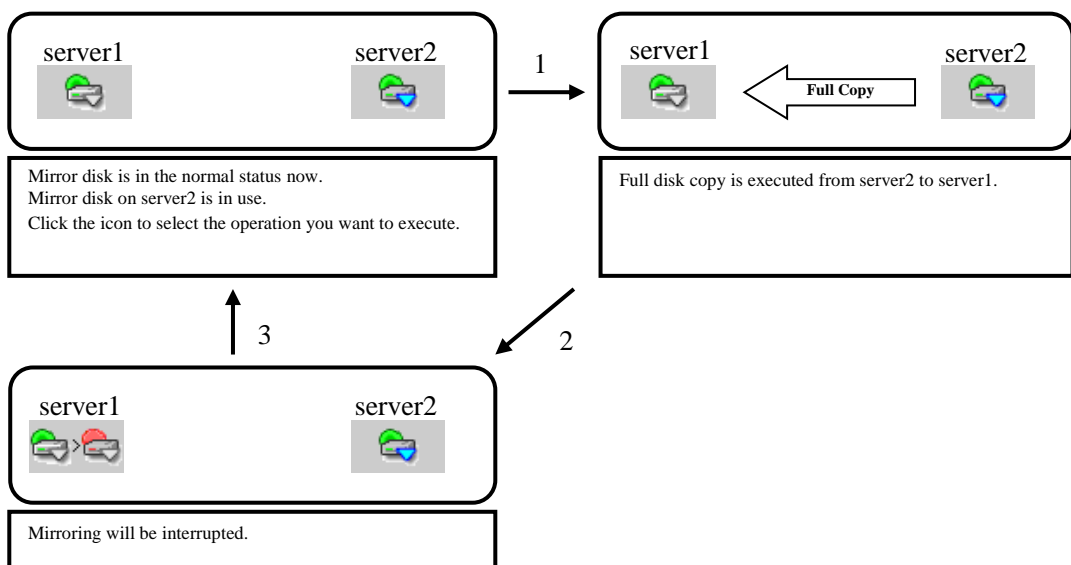

- A) Mirror recovery  
Recovers a mirror from server2 to server1. Full mirror recovery can be performed.
- B) Mirror disk disconnection  
Disconnects a mirror disk resource/hybrid disk resource of server1. Mirror synchronization is suspended.
- C) Initialization  
Returns to the initial status. The current status is displayed.

## 3. When server2 is not normal

The following describes the operations which can be performed when mirror disk resource/hybrid disk resource is inactive on server1. The figure on the upper left indicates the initial screen. Arrows in the figure indicates transitions made when the mirror disk status icon of server1 is clicked.

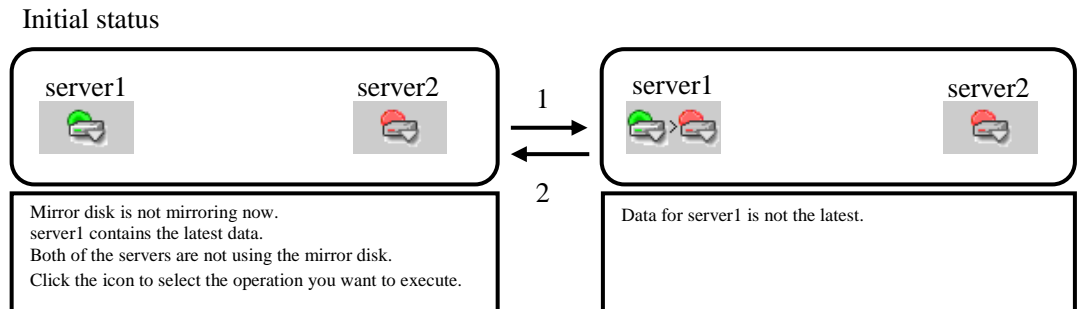
**Note:**

In the figure above, server2 is in abnormal status. Same transitions are made when the status of server2 is not normal.

- A) Mirror disk disconnection  
Disconnects a mirror disk/hybrid disk of server1. Causes a change from the state in which server1 contains the latest data to the state in which server1 does not contain the latest data.
- B) Initialization  
Returns to the initial status. The current status is displayed.

(2) Operation available when server1 is abnormal

1. When server2 is abnormal

The following describes the operations which can be performed when both servers are abnormal. The figure on the upper left indicates the initial screen. Arrows in the figure indicates transitions made when the mirror disk status icon of server1 is clicked.

Initial status

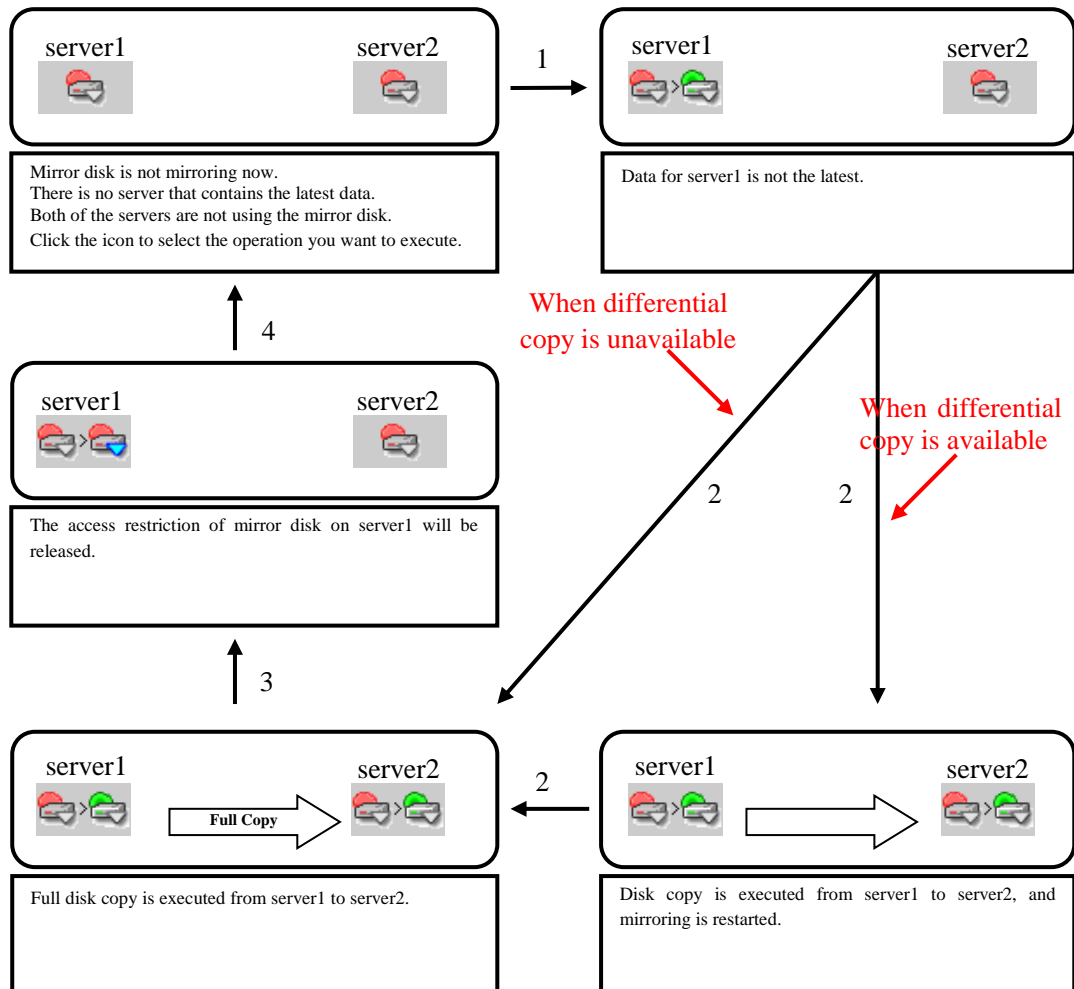

- A) Forcible mirror recovery on only server1  
 Makes the status of a mirror disk/hybrid disk normal forcibly. (Causes a change to the state in which server1 contains the latest data.)  
 When the status of a mirror disk/hybrid disk becomes normal, mirror disk resource/hybrid disk resource can be activated on server1.
- B) Mirror recovery  
 Recovers a mirror from server1 to server2. If differential copy can be performed, differential or full mirror recoveries are available. Mirror disk resource/hybrid disk resource cannot be activated while a mirror is being recovered.
- C) Access restriction cancellation  
 Usually, the mirror and hybrid disks, which are in the abnormal status, cannot be accessed.  
 Forcibly cancel the access restriction for the mirror and hybrid disks of server1 and then mount the file system so that they can be temporarily accessed.

(This does not place them in the normal active status.)

Mirror data is not synchronized even if any writes are made.

D) Initialization

Returns to the initial status. The current status is displayed.

2. When server2 is normal

The following describes the operations which can be performed when mirror disk resource/hybrid disk resource is inactive on server2. The figure on the upper left indicates the initial screen. Arrows in the figure indicates transitions made when the mirror disk status icon of server1 is clicked.

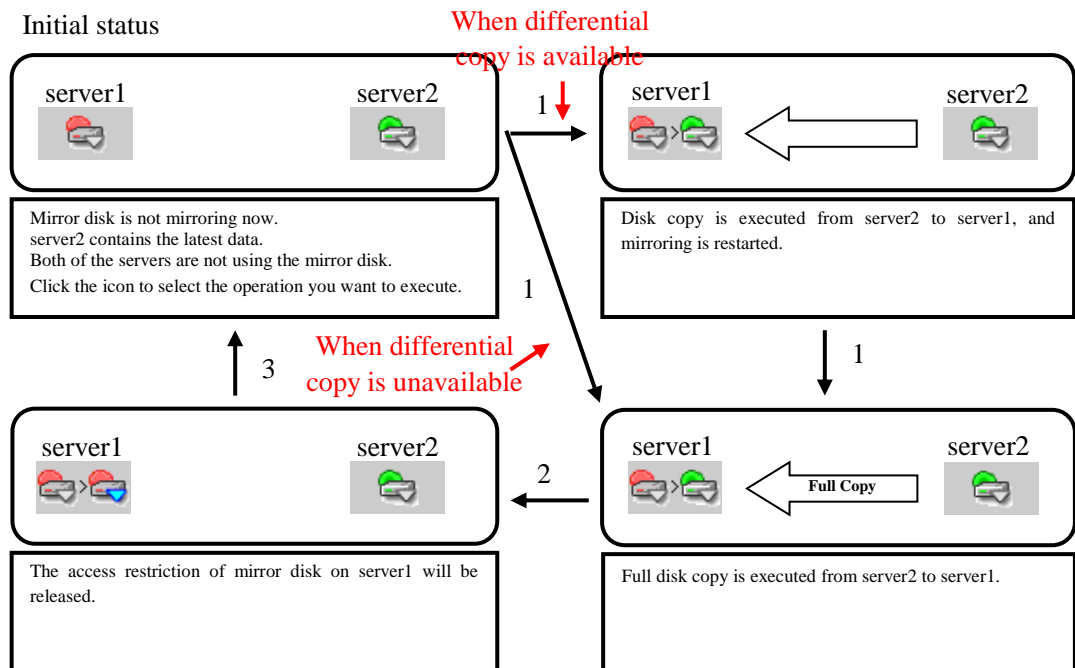

**Note:**

In the figure above, mirror disk resource/hybrid disk resource is inactive. Same transitions are made when a mirror disk resource/hybrid disk resource is active.

A) Mirror recovery

Recovers a mirror from server2 to server1. If differential copy can be performed, differential or full mirror recoveries are available. Mirror disk resource/hybrid disk resource cannot be activated while a mirror is being recovered.

When mirror recovery is started, mirror disk resource/hybrid disk resource cannot be activated while mirror recovery is being executed.

B) Access restriction cancellation

Usually, the mirror and hybrid disks, which are in the abnormal status, cannot be accessed.

Forcibly cancel the access restriction for the mirror and hybrid disks of server1 and then mount the file system so that they can be temporarily accessed.

(This does not place them in the normal active status.)

Mirror data is not synchronized even if any writes are made.

C) Initialization

Returns to the initial status. The current status is displayed.

3. When the status of server2 is unknown

The following describes the operations which can be performed when the status of server2 cannot be checked. The figure on the upper left indicates the initial screen. Arrows in the figure indicates transitions made when the mirror disk status icon of server1 is clicked.

Initial status

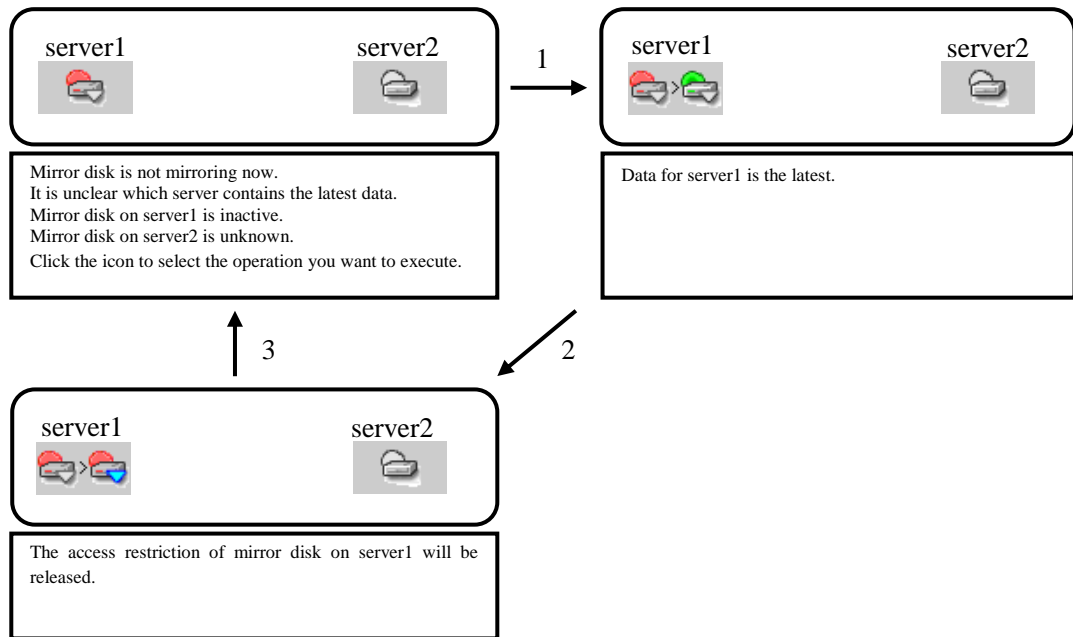

- A) Forcible mirror recovery on only server1  
Makes the status of a mirror disk/hybrid disk on server1 normal forcibly. When the status of a mirror disk/hybrid disk becomes normal, mirror disk resource/hybrid disk resource can be activated on server1.
- B) Access restriction cancellation  
Usually, the mirror and hybrid disks, which are in the abnormal status, cannot be accessed. Forcibly cancel the access restriction for the mirror and hybrid disks of server1 and then mount the file system so that they can be temporarily accessed. *(This does not place them in the normal active status.)* Mirror data is not synchronized even if any writes are made.
- C) Initialization  
Returns to the initial status. The current status is displayed.

**(3) Operation available while a mirror is being recovered****Note:**

The following operations can be performed only when mirror disk resource/hybrid disk resource is not activated on server1.

The following describes the operations which can be performed when mirror has been recovered. The figure on the upper left indicates the initial screen. Arrows in the figure indicates transitions made when the mirror disk status icon of server1 is clicked.

Initial status

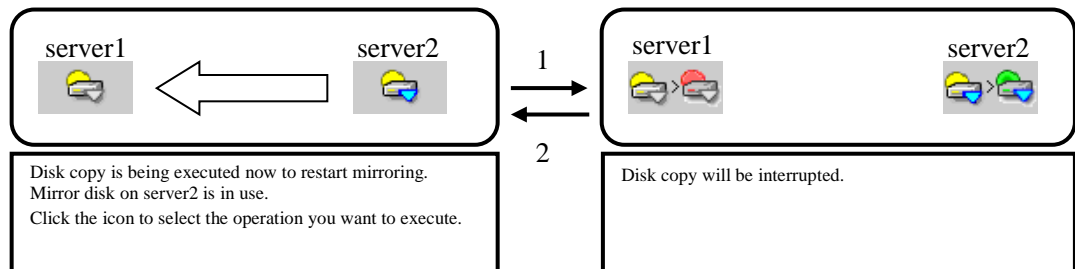
**Note:**

In the figure above, mirror disk resource/hybrid disk resource is active on server2. Same transitions are made when mirror disk resource/hybrid disk resource is inactive on server2.

- A) **Mirror recovery suspension**  
Suspends a mirror recovery. When the recovery is suspended, the status of a copy source mirror becomes normal and of a copy destination mirror becomes abnormal.
- B) **Initialization**  
Returns to the initial status. The current status is displayed.

**(4) Operation available when the access restriction is canceled**

The following describes the operations which can be performed when the access restriction of a mirror disk/hybrid disk is canceled. The figure on the upper left indicates the initial screen. Arrows in the figure indicates transitions made when the mirror disk status icon of server1 is clicked.

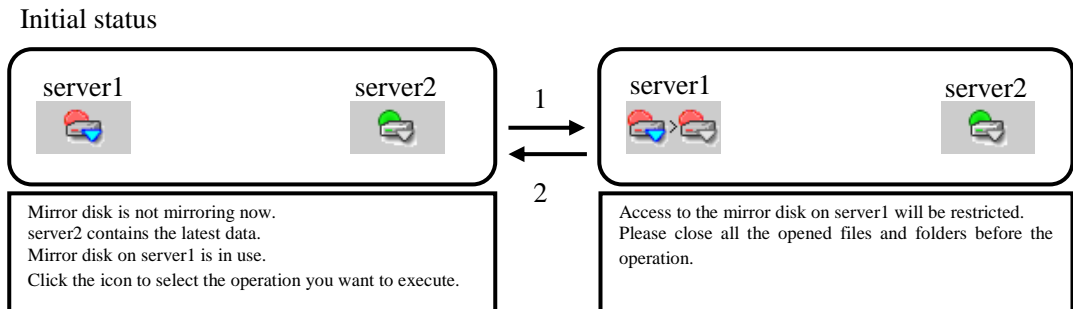

---

**Note:**

In the figure above, a mirror disk/hybrid disk on server2 are normal. Same transitions are made regardless of its status.

---

**Note:**

Even if access restriction is not canceled, the status shown in the figure above may be assumed.

This situation arises when a mirror disk resource on server1 is operating alone in the normal active status and server2, which contains the latest data, starts up. At this time, the mirror disk resources on both servers will contain the latest data, but server1 changes from the normal active status to the abnormal active status, and server2 changes from unknown status to the abnormal inactive status, assuming the status in the figure above.

In this case, the mirror disk resource on server1 is in the normal active status, not the access restriction canceled status that is assumed is the case of a temporary forcible operation. Thus, do not perform the operation described here, but forced mirror recovery. For an explanation of forced mirror recovery, see “Performing forced mirror recovery with the WebManager”, "Troubleshooting”, and “Performing forced mirror recovery with a command” in Chapter 11.

---

- A) Access restriction  
Return the mirror disk and hybrid disk on server1 from the access restriction status to the original status, and then restrict access. Unmount the mounted file system.
- B) Initialization  
Returns to the initial status. The current status is displayed.



**(5) Operation available when server1 is suspended.**

## 1. When server2 is suspended

The following describes the operations which can be performed when the hybrid disks on the both servers are suspended. The figure on the upper left indicates the initial screen. Arrows in the figure indicates transitions made when the mirror disk status icon of server1 is clicked.

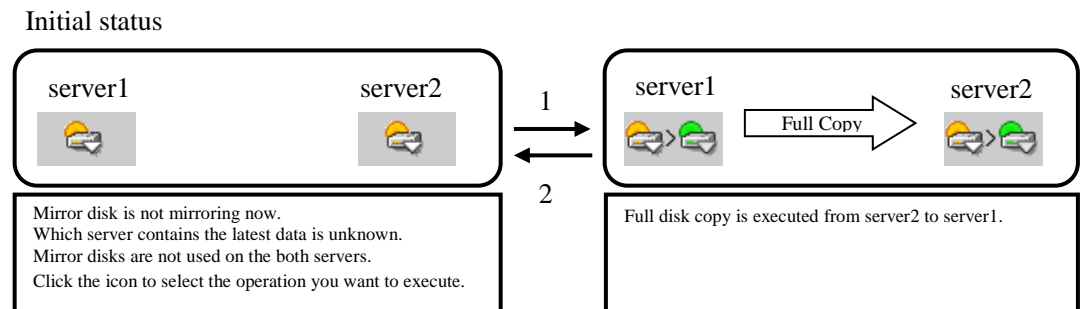

- A) Mirror recovery  
Recovers a mirror from server1 to server2. Full mirror recovery is performed. Hybrid disk resource cannot be activated while mirror is being recovered.
- B) Initialization  
Returns to the initial status. The current status is displayed.

## 2. When the status of server2 is unknown:

The following describes the operations which can be performed when the status of server2 cannot be checked. The figure on the upper left indicates the initial screen. Arrows in the figure indicates transitions made when the mirror disk status icon of server1 is clicked.

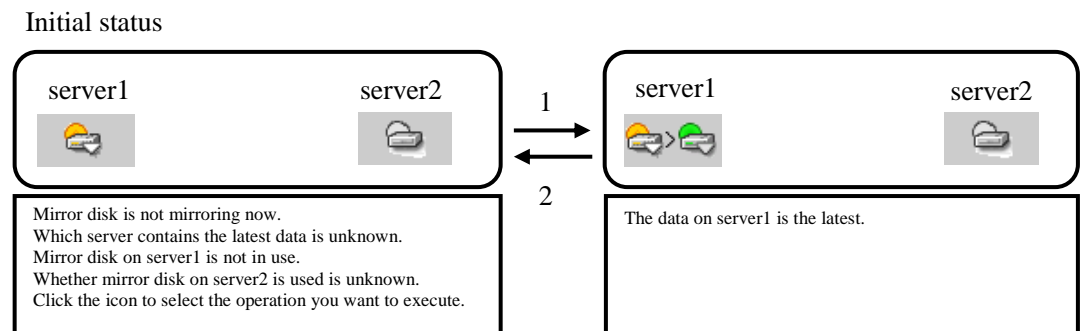

- A) Forcible mirror recovery on only server1  
Makes the status of a hybrid disk normal forcibly. When the status of a hybrid disk becomes normal, hybrid disk resource can be activated on server1
- B) Initialization  
Returns to the initial status. The current status is displayed.

## Recovering a mirror (forcefully)

### 1. Mirror recovery

**If there is a difference between the mirror disks on both servers:**

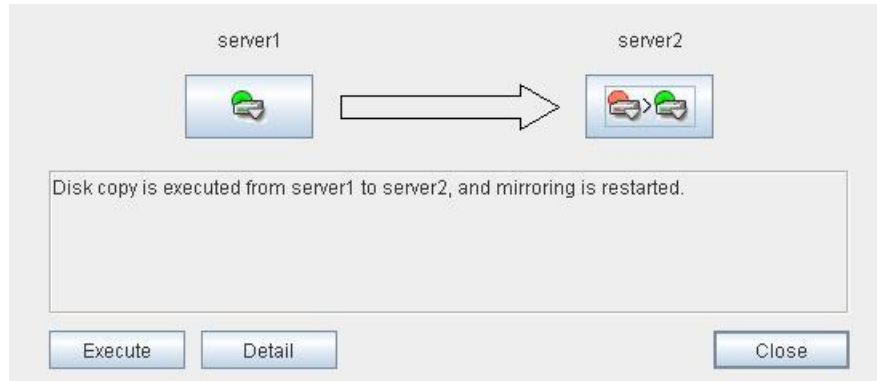

If there is a difference between the mirror disks on both servers, and one of the servers has an error, the progress bar direction is fixed. If the group is active, the server on which the group is active becomes the copy source server.

When you click **Execute**, mirror recovery starts.

**If there is no difference between the mirror disks on both servers:**

If there is no difference, full copy is performed to recover a mirror.

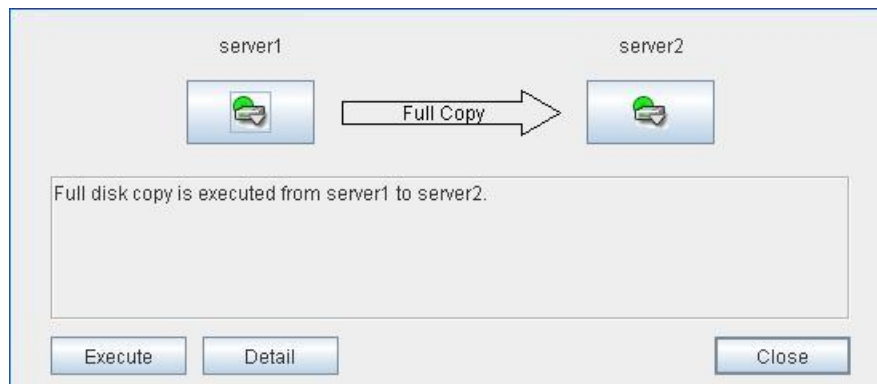

If there is no difference between the mirror disks of both servers, and both servers are running normally, the progress bar arrow is displayed when a source server is specified in the dialog box above. If the group is active, the server on which the group is active becomes the copy source server.

When you click **Execute**, forced mirror recovery starts.

## 2. Forced mirror recovery

If both servers have errors, click **Details** to determine a source server. When you click **Details**, the following detailed information is displayed.

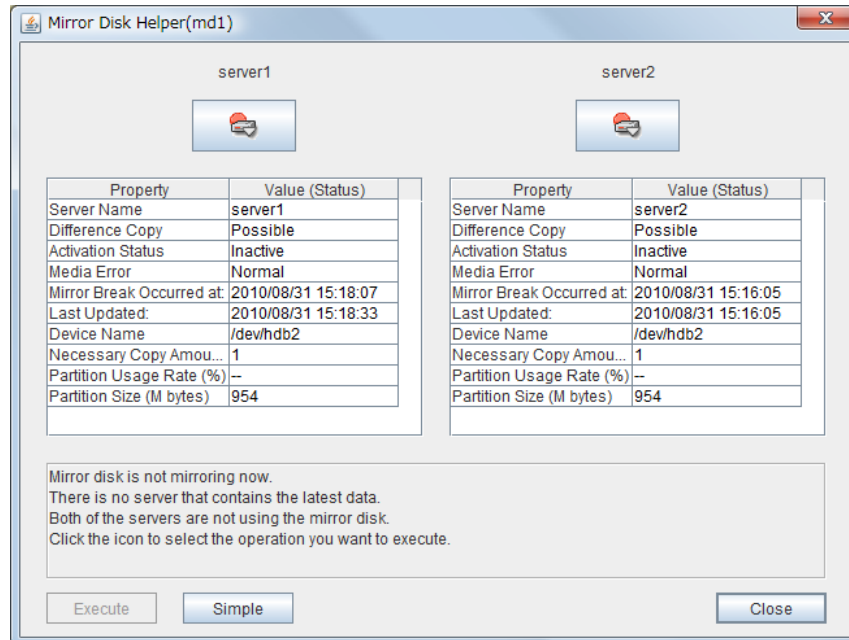

Check the **Last Data Update Time**, and choose a server with the latest data as the source server. Note that the time you see here is of the OS.

If you select an icon whose status is mirrored disk as the source, the progress bar is displayed. Click **Execute** to start forced mirror recovery.

### Note:

If the mirror disk is active, and if you want to perform forced mirror recovery with WebManager, you must first deactivate the group and then perform the operation described above.

For an explanation of forced mirror recovery, see “Performing forced mirror recovery with the WebManager”, “Troubleshooting”, and “Performing forced mirror recovery with a command” in Chapter 11.

3. Forced mirror recovery only for a single server

When one server has an error while the other is in the unknown status or stopped, the Mirror Disk Helper is displayed.

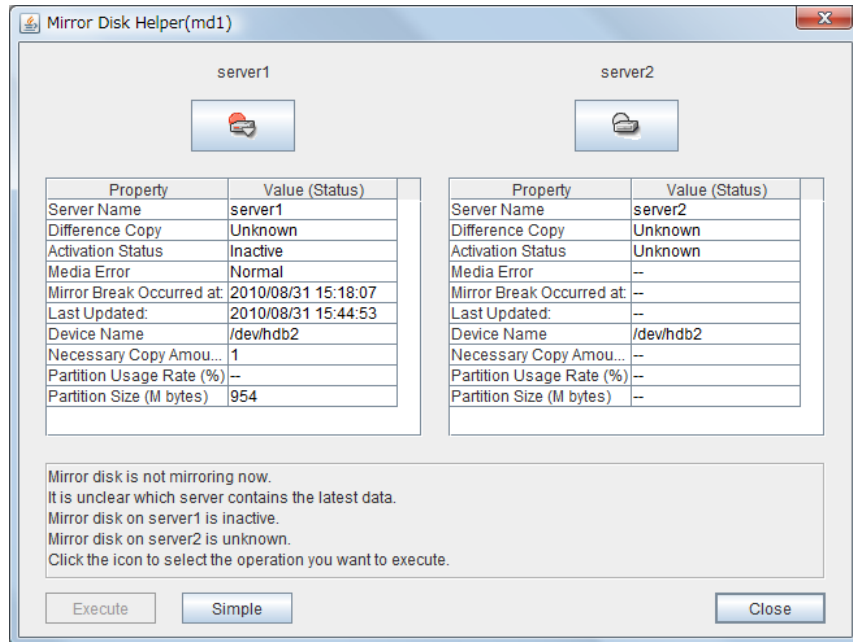

Click the icon of the server with an error to display the following:

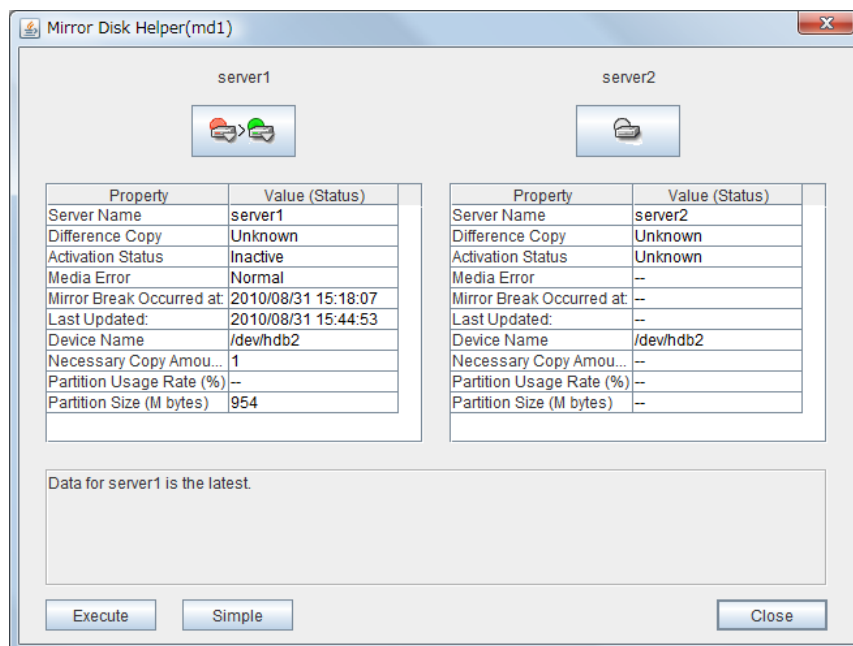

When you click **Execute**, the following dialog box is displayed. Clicking **OK** starts forced recovery only for one of the servers.



## Stopping mirror recovery

What is similar to the following is displayed during mirror recovery:

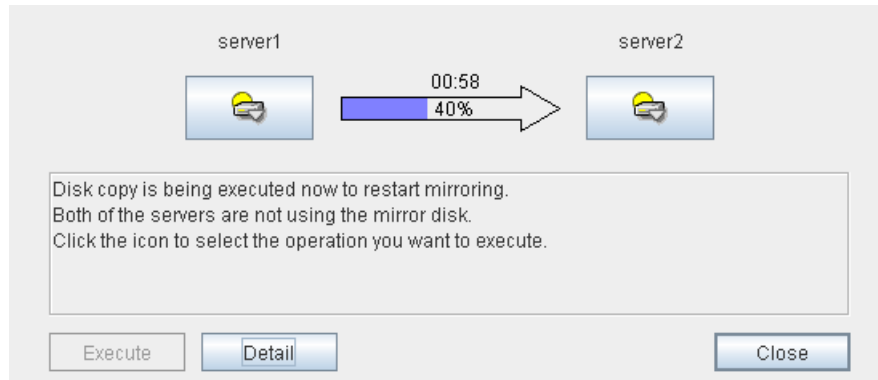

When you click the icon of the server where data will be copied to or from, the following is displayed:

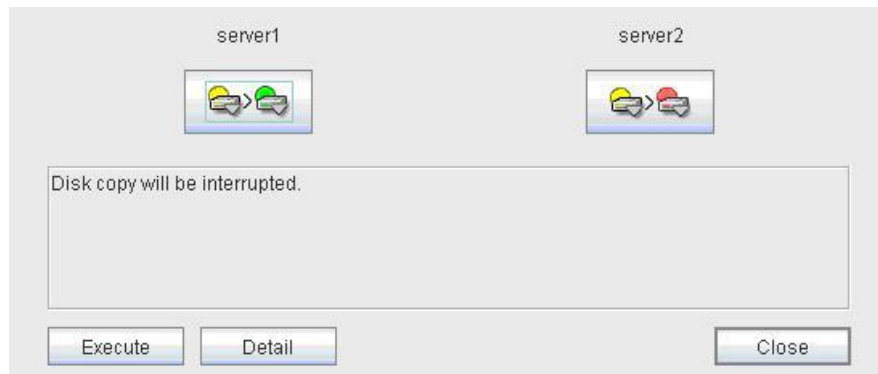

When you click **Execute**, the following dialog box is displayed. If you click **OK**, mirror recovery stops. The server where data is copied from becomes normal status and copied to become error status:



## Canceling access restriction

Canceling the access restriction can be performed only when the status of server is error. When the status of one server is normal and other server is error, the following is displayed:



Click the icon of the server with an error a few times to display the following:



When you click **Execute**, access restriction is canceled in the server with an error and a file system is temporarily mounted and becomes accessible. Mirror data is not synchronized even when any writes are made.

To perform mirror recovery, click the icon corresponding to the server for which access restriction has been canceled, apply access restriction again, and then follow the procedure described in "Recovering a mirror (forcefully)" on page 102.

## Disconnecting a mirror disk

Disconnecting a mirror disk can be performed on the server where a mirror disk is not activated and its status is normal. Mirror is not synchronized while a mirror disk is disconnected.

When the status of one server is normal and another is error, the following is displayed:



Click the icon of a server in normal status a few times to display the following:



When you click **Execute**, a mirror disk on the selected server is disconnected.

Even if both servers are in the normal status and inactive status, a mirror disk can be disconnected by performing a similar operation.



## Changing a current server (Only for hybrid disk resource)

You can change a current server on the status like below.

Hybrid disk status		Whether or not current server can be changed		Possible operation	
Server group 1	Server group 2	Server group 1	Server group 2	Server group 1	Server group 2
normal/inactive	normal/ inactive	Yes	Yes	1	1
normal/inactive	error/ inactive	Yes	Yes	1	1, 3
normal/active	error/ inactive	No	Yes	-	1, 3
error/ inactive	error/ inactive	Yes	Yes	1,3	1, 3
error/ inactive	error/forcibly activated	Yes	No	3	-
error/ inactive	Unknown	Yes	No	3	-
suspended/ inactive	suspended/ inactive	Yes	Yes	1	1

1	Recovering mirror (differential/entire data)
2	Forcefully recovering mirror on one server
3	Canceling access restriction (Forcible activation)
4	Disconnecting a mirror disk

When the both servers are normal or inactive, the servers are indicated as follows:

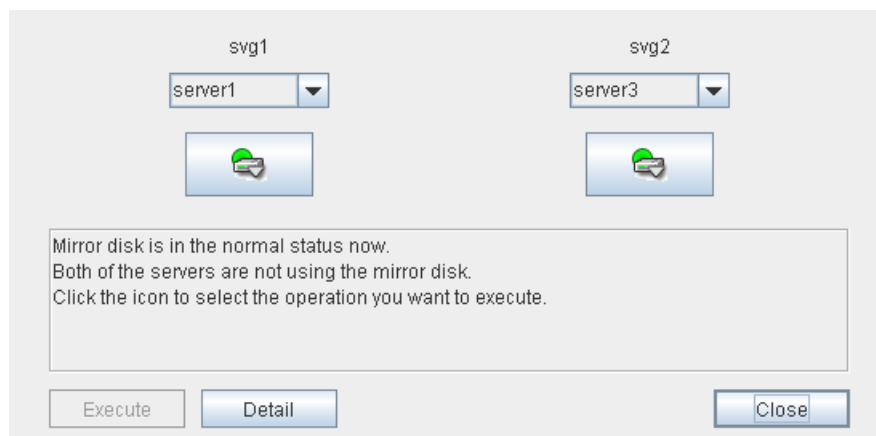

Select the operation to be executed and a name of the target server from the list box of server group containing the current server, and then select **Execute**. The current server will be switched.

## Manually setting WebManager to stop and start

After EXPRESSCLUSTER is installed, the WebManager on servers is configured to start up or stop as the OS starts up or stops.

Run the following commands from the server console to stop and start the WebManager manually.

### To stop

```
[root@server1 root]# /etc/init.d/clusterpro_alertsync stop  
Shutting down clusterpro webalert: OK  
[root@server1 root]# /etc/init.d/clusterpro_webmgr stop  
Shutting down clusterpro webmanager server: OK
```

### To start

```
[root@server1 root]# /etc/init.d/clusterpro_webmgr start  
Starting clusterpro webmanager server: OK  
[root@server1 root]# /etc/init.d/clusterpro_alertsync start  
Starting clusterpro webalert: OK
```

---

### Note:

For the above commands, only type the bold characters.

---

## Changing the settings without using the WebManager

If you do not want to use the WebManager for security reasons, change the settings of your OS or that of the Builder not to start the WebManager.

You can use the `chkconfig / update-rc.d` command to control startup and stop of the WebManager-related daemon.

### To prevent WebManager from starting up

```
[root@server1 root]# chkconfig --del clusterpro_alertsync
[root@server1 root]# chkconfig --del clusterpro_webmgr
```

For Ubuntu, run the following.

```
[root@server1 root]# update-rc.d -f clusterpro_alertsync remove
[root@server1 root]# update-rc.d -f clusterpro_webmgr remove
```

### To get WebManager to start up

```
[root@server1 root]# chkconfig --add clusterpro_webmgr
[root@server1 root]# chkconfig --add clusterpro_alertsync
```

For Ubuntu, run the following.

```
[root@server1 root]# update-rc.d clusterpro_webmgr defaults 91 4
[root@server1 root]# update-rc.d clusterpro_alertsync defaults 92 3
```

---

### Note:

For the above commands, only type the bold characters.

---

The WebManager can be configured on the **WebManager** tab in **Cluster Properties** of the Builder. For information on how to configure and apply the settings, see “Cluster properties WebManager tab” in Chapter 2 “Functions of the Builder” in this guide.

## Setting usage limitations

The limitation in connection and operation of the WebManager can be configured in **Cluster Properties** in the Builder. For details, see "Cluster properties WebManager tab" in Chapter 2 "Functions of the Builder" in this guide.

### Type of limitation

There are two ways to set usage limitations:

- ◆ Limiting the access by using client IP addresses
- ◆ Limiting the operation by using a password

#### Limiting the access by using client IP addresses

This function limits clients who can access the WebManager and operations on the WebManager by using client IP addresses.

Add IP addresses to **IP Addresses of the Accessible Clients** on the **WebManager** tab in the **Cluster Properties** of the Builder.

When setting the limitation of the connection of the WebManager, if you attempt to access to the WebManager from the IP address that is not added to **IP Addresses of the Accessible Clients** , the following error messages are displayed.

Example: when using the Internet Explorer

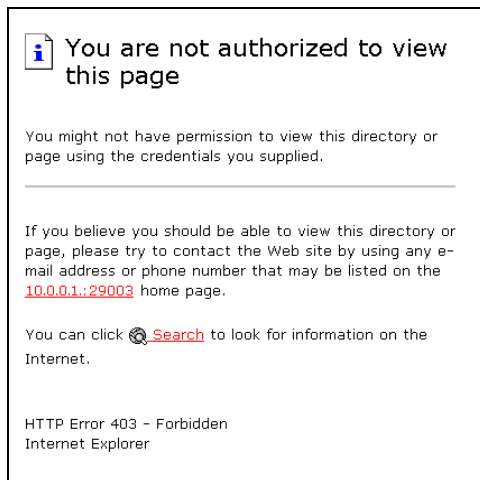

The following **Reference Mode** is displayed to the WebManager that is connected from the client registered to limit the operation.

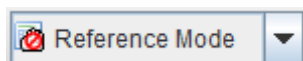

If you limit operations, you cannot perform the following operations from the WebManager.

- ◆ Shutdown and shutdown reboot of a cluster
- ◆ Shutdown and shutdown reboot of servers
- ◆ Starting, stopping, and moving of groups
- ◆ Operation using the Mirror Disk Helper (only when the Replicator/Replicator DR is used)
- ◆ Change to operation mode
- ◆ Change to config mode
- ◆ Change to verification mode

#### The limitation by using a password

This function limits viewing and operations on the WebManager by using a password.

To configure this limitation: in **Cluster Properties** of the Builder, click the **WebManager** tab and then **Control connection by using password**.

Once password limitation of the WebManager is set, the following authorization dialog box is displayed when trying to access the WebManager by setting a password.

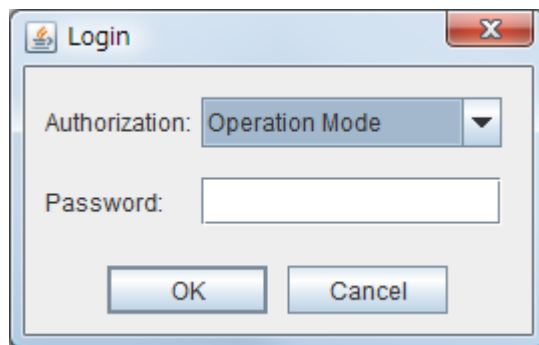

You can log on to the WebManager by selecting **Operation Mode** or **Reference Mode** in **Authorization** and entering a correct password.

- ◆ The authorization dialog box is not displayed when the password limitation is not configured (you can log on to the WebManager without authorization).
- ◆ You cannot log on to the WebManager if you enter a wrong password three consecutive times.

When you log on with a reference-only authorization, the following **Reference Mode** is displayed.

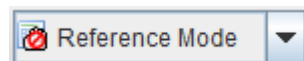

The following operations cannot be performed from the WebManager when operations are limited.

- ◆ Shutdown and shutdown reboot of a cluster
- ◆ Shutdown and shutdown reboot of servers
- ◆ Starting, stopping, and moving of groups
- ◆ Operation using the Mirror Disk Helper (only when the Replicator or Replicator DR is used)

For the information on switching the authorization after log on and/or log out, “Switch authorization of the WebManager” in Chapter 2 “Functions of the Builder”.

**Combination of the IP address and password**

The operational limitations when using both IP addresses and passwords are the following:

	Password limitation		
Client IP address limitation	Operable mode	Reference only	Unable to operate/view (authorization failed)
Operable Mode	Operable mode	Reference only	Unavailable
Reference Only	Reference only*	Reference only	Unavailable
Cannot Access	Cannot access	Cannot access	Cannot access

\* Authorization cannot be selected.

---

**Note:**

Changing the configuration data with the online version Builder is possible only when the WebManager is on the operable mode.

---

## Switch authorization of the WebManager

The chart below describes the flow of accessing the WebManager and switching authorization.

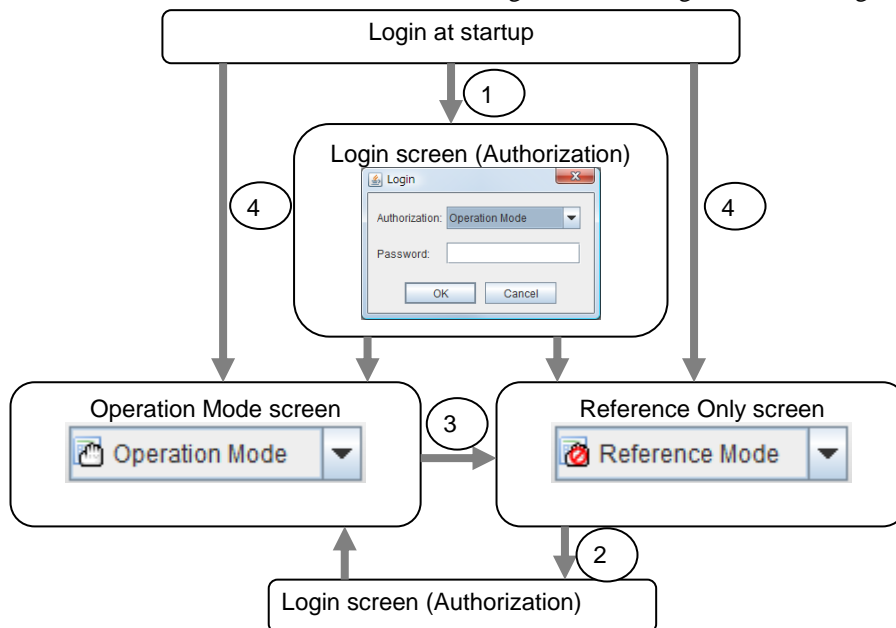

### 1. Log on to the WebManager

The log on authorization dialog box is displayed when a password for operation mode or reference only is set. You can log on to the WebManager by selecting the authorization of either **Operation Mode** or **Reference Only** and entering the correct password.

### 2. Switch the authorization from the reference only screen to the operation mode screen

The dialog box for password authorization is displayed. You can log on by entering the correct password. When password limitation is not configured, log on without entering a password.

### 3. Switch the authorization from the operation screen to the reference only screen

Authorization can be switched without authentication. You can do so even when the password limitation is configured.

### 4. Log on when a password for both operation mode and reference only is not set

Log on by following the client IP limitation. If the client IP limitation is not configured, log on to the WebManager whose authorization is in the operation mode. In this case, you cannot switch the authorization to reference only.

## Operating a cluster by using the WebManager

### Cluster shutdown and cluster shutdown reboot

For information on performing cluster shutdown and cluster shutdown reboot from the WebManager, see "Objects of the cluster" on page 58.

### Mirror disk resource, hybrid disk resource and mirror disk helper

For information on how to use the mirror disks, hybrid disk resources, and Mirror Disk Helper from the WebManager, see "Servers object" on page 60.

### Shutting down and rebooting an individual server

For information on how to shut down and reboot an individual server from the WebManager, see "Individual server objects" on page 62.

### Starting, stopping, and moving an individual group

For information on how to start, stop, and move an individual group from the WebManager, see "Individual failover group **objects**" on page 64.

### Starting and stopping an individual resource

For information on how to start and stop an individual resource from the WebManager, see "Individual group resource objects (except mirror disk resources, hybrid disk resources, and VM resources)" on page 67 or "Mirror disk resource object and hybrid disk resource object" on page 68.

### Suspending and resuming a monitor resource

For information on how to suspend and resume a monitor resource from the WebManager, see "**Monitors object**" on page 69.

### Suspending and resuming an individual monitor resource

For information on how to suspend and resume an individual monitor resource from the WebManager, see "**Individual monitor resource objects**" on page 72.



## Limitations of the WebManager

- ◆ Information displayed by the WebManager does not always apply the latest status. To acquire the latest information, click the reload icon on the toolbar or **Reload** on the **Tool** menu.
- ◆ If a server fails while the WebManager is acquiring information, the information acquisition fails, which may result in the failure to show some objects. You can either wait until the next auto refresh starts or click the reload icon on the toolbar or **Reload** on the **Tool** menu to acquire the latest information.
- ◆ If you use a Linux browser, some window manager combinations may put a dialog box behind other windows. Switch windows by pressing the **ALT + TAB** keys or by other means.
- ◆ The EXPRESSCLUSTER logs cannot be collected from two or more WebManager servers simultaneously.
- ◆ If you work on the WebManager when no connectivity is established, it may take a while to regain control.
- ◆ While the mouse pointer is the hourglass which indicates that the OS is processing something, moving the cursor outside the browser may return to the arrow icon even if the process is still underway.
- ◆ When you collect logs, the following message may be displayed in a server console:

```
hda: bad special flag: 0x03
ip_tables: (C) 2000-2002 Netfilter core team
```

You can ignore this message because it does not affect log collection.
- ◆ If a proxy server is used, configure the proxy server so that the port number of the WebManager can be relayed.
- ◆ When a reverse proxy server is used, the WebManager does not run normally.
- ◆ When you update EXPRESSCLUSTER, close the browser. Clear the cache of Java and restart the browser.
- ◆ If the client PC to connect to WebManager uses Java Runtime Environment (JRE) 7 Update 25 or later, and cannot be connected to the Internet, it may take time to start WebManager. This can be avoided by setting **Execute Certificate Revocation Check** to **Not Check** on Detailed Settings on the Java Control Panel. For details of how to set it, check the Java website.

## Error messages on the WebManager

The following is a list of error messages displayed when using the WebManager.

Level	Message	Cause	Solution
Error	Could not start the group because necessary responses have not been made.	No status is acquired because EXPRESSCLUSTER is now being started up.	Try reloading the status later.
Error	Could not connect to the server.	Connecting the WebManager to the EXPRESSCLUSTER server failed.	Check if the destination server is running.
Error	Connection Timeout	Internal time-out occurred.	Internal time-out may occur when a time-consuming task is performed. Check the status after the time-out and if there is no problem, you can continue your operations.
Error	Connection is terminated.	The connection between the WebManager and the EXPRESSCLUSTER is disconnected.	Check if the connection destination server has failed.
Error	Could not activate some resources.	Failed to start some resources under the group.	Solve the problem that caused the resource error.  See the alert log for the detailed information on the error.
Error	Could not deactivate some resources.	Failed to stop some resources under the group.	Solve the problem that caused a resource error.  For the detailed information on the error, see the alert log.
Error	Failed to collect cluster logs from the server.	Failed to collect cluster logs.  Some servers may have been shut down during the cluster log collection.  There is a possibility that there is an error and some servers cannot be accessed.	Retry cluster log collection.  If logs from a certain server cannot be collected, run the <code>clplogcc</code> command on the server to collect logs.
Error	Failed to connect to server(%1 : %2)	Failed to connect to the WebManager.	Check if the WebManager is running on the server.
Error	Failed to find group online server.	Failed to detect the server whose group is online.	The server status may have changed during the operation. Reload the status.
Error	Failed to get data for the cluster tree view from the server.	Failed to acquire the cluster configuration.	Check if EXPRESSCLUSTER is running on the server by using a command.

Level	Message	Cause	Solution
Error	Failed to get the latest alert log.	1) The alertlog. alt file does not exist or is corrupted. 2) The number of the alert viewer records in the cluster configuration data is over the limitation. (Up to 999)	1) Temporarily store all the files under the <i>/installation_path/alert/log</i> on the server, and then restart the alert synchronization service. 2) Check the maximum number of the alert view records set in the Builder.
Error	Failed to get property from the server.	Failed to acquire a cluster property value.	Run a command on the server to check if EXPRESSCLUSTER is running.
Error	Failed to search the alert logs.	Failed to open alert log files on a server.	Temporarily store the files under the <i>/installation_path/alert/log</i> on the server, and then restart the alert synchronization service.
Error	The response content is invalid.	Connection to the server is disconnected.	Check the server operating status and network connectivity.
Error	Failed to move group "Group Name" to server "Server Name".	Moving the group failed. [Group Name] group_name [Server Name] server_name	Solve the problem causing the failure of moving a group. For the detailed information on the error, see the alert log.
Error	The group is already started.	The target group has already been started up. Other manager or command on the server may have performed operations to the same group.	Try reloading the group status later to update it, and then perform operations to the group.
Error	The group is already stopped.	The target group has already been stopped. Other manager or command on the server may have performed operations to the same group.	
Error	Group is updating its status.	The status of the target group is changing. Other manager or command on the server may have performed operations to the same group.	
Error	Internal error.	An internal error of the WebManager occurred.	Perform reloading. If the same error occurs even after reloading, restart the WebManager daemon.

Level	Message	Cause	Solution
Error	Invalid configuration data.	Failed to acquire the cluster configuration data.	Check the information on the cluster configuration.
Error	Invalid group name.	An internal error of the WebManager occurred.	Perform reloading. If the error occurs even after reloading, restart the WebManager daemon.
Error	Invalid group name or server name.	An internal error of the WebManager occurred.	
Error	Invalid parameter.	An internal error of the WebManager occurred.	
Error	Invalid server name.	An internal error of the WebManager occurred.	
Error	An error occurred in server or group operation.	Some operations failed.	Run a command to check the server status. If there is no problem, you can continue your operations.
Error	Operatable group does not exist.	The operation to the group failed.	Solve the problem that caused the failure of the operation to the group.  For the detailed information on the error, see the alert log.
Error	Enter the number of alert logs displayed on each page.	The number of the alert log filter result to be displayed (for example, the number of logs in a window) is not set.	Specify the number of the alert log filter result to be displayed.
Error	Enter the event ID.	The ID for alert log search is not set.	Specify the ID for alert log search.
Error	Enter the module name.	The name of the module for the alert log search is not set.	Specify the name of a module for the alert log search.
Error	Enter the number of searches.	The number of alert logs to be searched is not set.	Specify the number of alert logs to be searched for.
Error	Enter the page number.	The page to show the results of the alert log research is not set.	Specify the page to show the results of the alert log research.
Error	Enter the server name.	The name of a server for alert log search is not set.	The name of the target server for the alert log search is not specified.
Error	Specified server is not active.	The server that initiated the operation is not active.	Wait for a while to perform reloading to update the group, and then perform the operation the group.
Error	Specified server is not active.	The server that initiated the operation is not active.	Wait for a while to perform reloading to update the group, and then perform the operation.

Level	Message	Cause	Solution
Warning	The cluster tree obtained from the server may not be completed.	An error occurred while acquiring the server's status.	Try reloading later.
Error	The number of alert logs per page you have entered is not in the specified range (1 to 300).	The specified number of alert log filter results displayed per page is out of the range.	Specify a value between 1 and 300.
Error	The value in "To" is incorrect. Enter the correct value.	The time specified for end of alert log search is invalid.	Set a correct time.
Error	Event ID entered is less than 1.	The ID set for the target of the alert log search is smaller than one.	Specify a value of 1 or greater.
Error	There are no groups that can be started.	Failed to start up a group.	Solve the problem that caused the failure of the operation to the group.  For the detailed information on the error, see the alert log.
Error	There are no groups that can be stopped.	Failed to stop the group.	Solve the problem that caused the failure of the operation to the group.  For the detailed information on the error, see the alert log.
Error	There are groups that failed to start.	Some operations failed.	Run a command to check the server status. If there is no problem, you can continue your operations.
Error	There are groups that failed to stop.	Some operations have failed.	Run a command to check the server status. If there is no problem, you can continue your operations.
Warning	The number of searches entered is less than 1.	The ID set for alert log search is smaller than one.	Specify a value of 1 or greater.
Error	Page number entered is less than 1.	The number of pages specified for the alert log search is smaller than one.	Specify a value of 1 or greater.
Error	The page number entered is greater than the total page number.	The number of pages specified for alert log search is greater than the number of total pages.	Specify the number that is smaller than the number of the total pages.
Warning	The properties got from server may not be completed.	Some information acquisition failed.	Try reloading later.

Level	Message	Cause	Solution
Error	There are groups that failed to stop.	There is a server that may have failed to shut down the cluster.	Check if the server has failed. If it has not failed, make sure that EXPRESSCLUSTER is running.
Error	The value in "From" is incorrect. Enter the correct value.	The time set for start of alert log search is invalid.	Set a correct time.
Error	The value set in "From" is later than the value in "To".	The time set for start of the alert log search is later than the time set for end.	Set a correct time.
Info	The total number of pages has been changed. The server alert log will be updated.	The number of total pages of alert log filter results is updated. New alerts may have been issued while the search results were being displayed.	To apply added alerts to the search results, close the window displaying the search results and perform search again.
Error	Failed to get mirror disk list from the server.	An internal error of the Mirror Agent occurred. Communication from the WebManager server to the Mirror Agent failed. The process on the server timed out.	Make sure that the Mirror Agent is working. If the Mirror Agent is not started, reboot the server.
Error	Failed to get mirror status.	The Mirror Agent failed to acquire mirror disk status. An internal error of the Mirror Agent occurred. Communication from the WebManager server to the Mirror Agent has failed. The process in the server timed out.	Check if the Mirror Agent is active. If the Mirror Agent is not started, reboot the server.
Error	Failed to recover the mirror since mirror status has changed.	An error occurred while performing mirror recovery.	Make sure that the Mirror Agent is operating. If the Mirror Agent is not started, restart the server.
Confirmation	Data on two disks are identical. Do you want to execute a mirror recovery?	The mirror disks on both servers have no difference.	-
Confirmation	%1 is recovering now. Are you sure you want to stop?	It was requested to stop during recovering.	-
Error	The local applet version does not match the server's. Close the browser and clear the applet cache.	A mismatch between the applet and the server occurred because the browser cache remains.	Exit the browser. Clear the cache of Java and restart the browser.

Level	Message	Cause	Solution
Error	Failed to get server list.	Failed to get a server list.	Check if other log collections are performed. Retry after others are completed. Reload after waiting for a while.
Error	Server is collecting cluster logs. Try again after cluster log collection is completed.	The server is collecting cluster logs.	Try again after other cluster log collections are completed.
Error	Failed to collect cluster logs from the server.	An error occurred while acquiring cluster logs.	Check the result in dialog box showing the progress of cluster log collection (see "Collecting logs")
Error	Failed to log on (Internal error)	An internal error occurred when logging on to the WebManager.	Try logging on to WebManager again. Start the WebManager daemon if the error still occurs.
Error	Failed to log on	Incorrect password was entered three consecutive times.	Try logging on to WebManager again with a correct password.
Error	Incorrect password.	Incorrect password was entered.	Enter a correct password.
Error	Authorization failed.	Password was changed when accessing the WebManager.	Try logging on to WebManager again.
Error	Authorization failed. (Internal error.)	An internal error occurred when accessing to the WebManager.	Try logging on to WebManager again. Reboot the WebManager daemon if the error still occurs.
Error	Failed to connect to the server.	Failed to access to the WebManager.	Check if the WebManager is running on the server. Check if the WebManager can be connected to the server successfully.
Error	Failed to get the list of mirror disk error.	The Mirror Agent failed to acquire the mirror disk information. An internal error of the Mirror Agent occurred. Failed to access from the WebManager server to the Mirror Agent. The process timed out on the server.	Check if the Mirror Agent is working. If not, restart the server.

Level	Message	Cause	Solution
Confirmation	Could not obtain the status of the other server. Are you sure you want to execute a forced recovery?	Forced mirror recovery was performed.	-
Confirmation	This cluster will be terminated. Do you want to continue?	The confirmation message for shutting down the cluster.	-
Confirmation	Are you sure you want to suspend "{0}"?	The confirmation message for suspending the cluster.  {0} is where the name of the cluster is described.	-
Confirmation	Are you sure you want to resume "{0}"?	The confirmation message for resuming the cluster.  {0} is where the name of the cluster is described.	-
Confirmation	Are you sure you want to start "{0}"?	The confirmation message for starting the cluster daemon.  {0} is where the name of the cluster is described.	-
Confirmation	Are you sure you want to stop "{0}"?	The confirmation message for stopping the cluster daemon.  {0} is where the name of the cluster is described.	-
Confirmation	Are you sure to restart the manager daemon?	The confirmation message for restarting the server-side service of WebManager.	-
Confirmation	Are you sure to start the mirror agent daemon?	The confirmation message for starting the mirror agent.	-
Confirmation	Are you sure to stop the mirror agent daemon?	The confirmation message for stopping the mirror agent.	-
Confirmation	Are you sure to suspend the cluster?	The confirmation message for suspending the cluster.	-
Confirmation	Are you sure to resume the cluster?	The confirmation message for resuming the cluster.	-
Confirmation	Are you sure to start the cluster?	The confirmation message for starting the cluster daemon.	-
Confirmation	Are you sure to stop the cluster?	The confirmation message for stopping the cluster daemon.	-



Level	Message	Cause	Solution
Confirmation	Warning: If the server is shut down, in order to recover the mirror which is used on this server to normal status, you need to execute mirror recover operation on it. It may cost long time to perform mirror recovery. Do you want to continue?	The confirmation message for shutting down some of the servers in the cluster. {0} is where the name of the server is described.	-
Confirmation	Warning: If the server is rebooted, in order to recover the mirror which is used on this server to normal status, you need to execute mirror recover operation on it. It may cost long time to perform mirror recovery.  Do you want to continue?	The confirmation message for rebooting some of the servers in the cluster. {0} is where the name of the server is described.	-
Confirmation	Are you sure you want to start "{0}"?	The confirmation message for starting a cluster daemon of some of the servers in the cluster. {0} is where the name of the server is described.	-
Confirmation	Are you sure you want to stop "{0}"?	The confirmation message for stopping a cluster daemon of some of the servers in the cluster. {0} is where the name of the server appears.	-
Confirmation	Are you sure you want to stop "{0}"?	The confirmation message which suspends a failover group. {0} is where the name of the group is described.	-
Confirmation	Are you sure you want to start "{0}"?	The confirmation message for starting some of the resources in the fail over group. {0} is where the name of the resource is described.	Note that the resources in dependency are also started.
Confirmation	Are you sure you want to stop "{0}"?	The confirmation message for stopping some of the resources in the fail over group. {0} is where the name of the resource is described.	Note that the resources in dependency are also stopped.

Level	Message	Cause	Solution
Confirmation	The file system of mirror disk on {0} maybe abnormal. Are you sure to execute a force recovery?	<p>Mirror recovery has stopped while performing the last mirror recovery. This disk was where to be copied.</p> <p>The mirror disk data of this server may be going to be abnormal when the mirror disk is forcibly recovered. If you execute a mirror recovery, this data is taken as the latest one.</p> <p>The name of the mirror resource is displayed where {0} is represented.</p>	It is recommended to forcibly recover a mirror disk of the other server.
Confirmation	The file system of mirror disk on {0} maybe abnormal. Could not obtain the status of the other server. Are you sure to execute a forced recovery?	<p>Mirror recovery has stopped while performing the last mirror recovery. This disk was where to be copied.</p> <p>The status of the other server cannot be obtained.</p> <p>The mirror disk data of this server may be going to be abnormal when the mirror disk is forcibly recovered. If you execute a mirror recovery or forcible recovery, this data is taken as the latest one.</p> <p>The name of the mirror resource is displayed where {0} is represented.</p>	It is recommended to forcibly recover a mirror disk of the other server.
Confirmation	The file system of mirror disk on {0} may have an error. Are you sure to connect to the mirror disk?	<p>Displayed when a mirror disk is manually performed to be active.</p> <p>Mirror recovery has stopped while performing the latest mirror recovery. This disk was where to be copied.</p> <p>The mirror disk data of this server may be abnormal.</p>	It is not recommended to continue activating a mirror disk because the file system of this disk may not be normal.
Confirmation	Are you sure you want to disable the dummy failures of all monitors?	Confirms whether dummy failure is disabled for all monitors when changing from verification mode to a different mode.	
Error	Error Cause:{0}	Failed in operations for mirror. For specific cause, refer to the descriptions in where {0} represents.	Refer to the description in where {0} represents.
Error	Failed to communication with mirror disk agent.	Failed to communicate between WebManager and mirror agent.	Make sure the mirror agent is running on each server in the cluster. If not running, restart a server.

Level	Message	Cause	Solution
Error	Communication between mirror disk agent timeout.	Timeout has occurred in communication between WebManager and the mirror agent.	Make the values of send/receive timeout of mirror agent of the cluster property larger.  When the load is temporarily high, change the ratio of timeout using the <code>clptoratio</code> command.
Error	Internal error.	Failed to allocate the memory, attach the shared memory or perform <code>ioctl ()</code> to the mirror driver.	Make sure that the setting value related to the mirror disk is properly configured.  Shut down and reboot the cluster.
Error	Invalid mirror disk alias.	The specified mirror disk is not found.	Click <b>Reload</b> to display the latest status of a cluster, and try again.
Error	Failed to get mirror disk information.	Failed to acquire the mirror disk information from the mirror agent.	Make sure that the setting value related to mirror disk is properly configured.  Shut down and reboot the cluster.
Error	Specified server name was not found.	The specified server is not found.	Click <b>Reload</b> to display the latest status of a cluster, and try again.
Error	Failed to get the diff percent of mirror disk.	Failed to acquire difference information of mirror disk from the mirror agent.	Make sure that the setting value related to mirror disk is properly configured.  Shut down and reboot the cluster.
Error	Invalid license.	Failed in operation because the registered license is invalid or expired.	Confirm the license.  Make sure the valid date when using a license for trial.
Error	Mirror disk has already been mounted.	The status of mirror activation operation from another WebManager or by the <code>clpmdctrl</code> command may not be applied on the display.	Click <b>Reload</b> to display the latest status of a cluster, and try again.
Error	Failed to get mirror disk status.	Failed to acquire the mirror disk status from the mirror agent.	Make sure that the setting value related to mirror disk is properly configured.  Shut down and reboot the cluster.

Level	Message	Cause	Solution
Error	Mirror disk status is not proper.	Possible cause is that the status of mirror is not applied on the display when any operation or transmission that would affect its status occurred.	Click <b>Reload</b> to display the latest status of a cluster, and try again.
Error	Failed to read date for cluster partition.	Failed to access a cluster partition.	Make sure that the cluster partition of mirror disk is properly configured.  Make sure the partition device set as a cluster partition is normal.
Error	Failed to write date to cluster partition.	Failed to access a cluster partition.	Make sure that the cluster partition of mirror disk is properly configured.  Make sure the partition device that set as a cluster partition is normal.
Error	Mirror disk is not mounted.	Failed in operation because a mirror disk is not mounted.  Possible cause is that the status of mirror deactivation operation from another WebManager or by the <code>clpmdctrl</code> command is not applied on the display.	Click <b>Reload</b> to display the latest status of a cluster, and try again.
Error	Failed to create mount point.	An error has occurred in the process of creating mount point when a mirror resource is being activated.	Make sure that setting value of mount point of mirror resource is properly configured.
Error	Failed to activate mirror disk, because mirror disk size of both server are not same.	The size of partition set to data partition is not the same between the both servers. Default mirror configuration is not operated in the specified direction.	Follow the steps below. 1. Inactivate the failover group that the mirror resource belongs to. 2. Make sure the data partition size of both servers. 3. Make sure that the server data with small size of data partition is the latest. 4. Operate a mirror recovery from the server with the small size of data partition to the server with the big size of data partition. 5. Activate the failover groups that the mirror resource belongs to.

Level	Message	Cause	Solution
Error	Failed to recover mirror disk in force mode.	Failed to forcibly recover the mirror disk.	<p>Make sure that mirror disk setting (especially cluster partition, port number) is not wrong.</p> <p>Make sure that the partition device set as a cluster partition is normal.</p>
Error	Failed to set mirror disk.	Failed in mirror disk-related operation.	<p>Make sure that mirror disk setting (especially cluster partition, port number) is not wrong.</p> <p>Make sure that the partition device set as a cluster partition is normal.</p> <p>Shut down and reboot a cluster.</p>
Error	Failed to get server list.	Failed to acquire the server list.	<p>Make sure that the setting of mirror disk does not contain any error.</p> <p>Shut down and reboot a cluster.</p>
Error	Mirror driver is abnormal.	Failed in operation due to a failure of driver of the mirror disk.	<p>Make sure that the driver of mirror disk (liscal) is loaded on each server by executing the <code>lsmmod</code> command.</p> <p>Make sure the version information of kernel supported by Replicator option/Replicator DR option and kernel version being used by referring to the startup guide.</p> <p>Shut down and reboot a cluster.</p>
Error	Failed to mirror driver status.	Failed in operation due to the failure of driver.	<p>Make sure that the driver of mirror disk (liscal) is loaded on each server by executing the <code>lsmmod</code> command.</p> <p>Make sure the version information of kernel supported by Replicator option/Replicator DR option and kernel version being used by referring to the startup guide.</p> <p>Shut down and reboot a cluster.</p>

Level	Message	Cause	Solution
Error	Specified recovery mode is invalid.	Failed to operate the mirror recovery because the specified reconfiguration mode is invalid.  Possible cause is that the status of mirror is not applied on the display when any operation or transition that would affect its status occurred.	Click <b>Reload</b> to display the latest status of a cluster, and try again.
Error	Failed to send recovery data.	Failed in mirror recovery because sending a recovery data failed.	Make sure the setting of mirror disk does not contain any error (especially in mirror connect).  Make sure that the network set to mirror connect is in normal state.
Error	Detected disk error while recovering the mirror.	Failed in mirror recovery because the disk error is detected.	Replace an error disk, and then try again.
Error	Failed to cancel recovery of mirror disk.	Failed to stop the process of mirror recovery.	Click <b>Reload</b> to display the latest status of a cluster, and try again.
Error	Failed to get sector number of mirror disk.	Failed in operation because acquiring the sector number of mirror disk failed.	Make sure that the setting of mirror disk (especially in partition) does not contain any error.
Error	Specified mirror disk is recovering now.	Failed in operation due to mirror recovery.  The status of mirror activation operation from another WebManager or by the <code>clpmdctrl</code> command may not be applied on the display.	Click <b>Reload</b> to display the latest status of the cluster.
Error	Mirror disk status is normal, it is not needed to recover.	Mirror recovery is not needed.  The status of mirror may not be applied on the display when any operation or transition that would affect its status occurred.	Click <b>Reload</b> to display the latest status of the cluster.
Error	Failed to fork process.	Failed in mirror recovery, because generating the process required for mirror recovery failed.	Confirm the status of the server where mirror is to be recovered.

Level	Message	Cause	Solution
Error	Recovery direction is not correct.	Failed in mirror recovery, because a direction of mirror recovery is invalid.  The status of mirror may not be applied on the display when any operation or transition that would affect its status occurred.	Click <b>Reload</b> to display the latest status of a cluster, and try again.
Error	Mirror disk has not been initial constructed.	Failed in operation, because default mirror is not configured for mirror disk.  The status of mirror may not be applied on the display when any operation or transition that would affect its status occurred.	Click <b>Reload</b> to display the latest status of a cluster, and try again.
Error	Recovery is canceled.	The status of mirror active operation from another WebManager or by the <code>clpmdctrl</code> command may not be applied on the display.	Click <b>Reload</b> to display the latest status of a cluster, and try again.
Error	Failed to recover mirror disk, because recovery source does not contain the latest data.	Failed in mirror recovery, because the disk which is a source of mirror recovery does not have the latest data.  The status of mirror may not be applied on the display when any operation or transition that would affect its status occurred.	Click <b>Reload</b> to display the latest status of a cluster, and change a source of reconfiguration and reconfigure it.
Error	Failed to recover since NMP size of recovery target is smaller than recovery source.	Failed in mirror recovery, because the size of data partition of mirror target is smaller than the one of recovery source.	This message is usually not displayed because the size of data partition is automatically adjusted at the time of initial mirror configuration.
Error	Failed to read configuration.	Failed in operation due to the error of cluster configuration information file.	Make sure that setting of mirror disk does not contain any error.
Error	System command return error.	Failed in operation, because the execution result of the command that is performed from mirror agent is error.  There is no EXPRESSCLUSTER executable file to be executed from mirror agent.	Make sure that the <code>bin/clprelpath</code> file is stored under the install directory of EXPRESSCLUSTER.
Error	Command(fsck) timeout.	Failed in operation, because timeout has occurred in executing the command ( <code>fsck</code> ).	Set a larger value for the <code>fsck</code> timeout of mirror resource.

Level	Message	Cause	Solution
Error	Command(mount) timeout.	Failed in operation, because timeout has occurred in executing the command (mount).	Set a larger value for the mount timeout of mirror resource.
Error	Command(umount) timeout.	Failed in operation, because timeout has occurred in executing the command (umount).	Set a larger value for the <code>umount</code> timeout of mirror resource.
Error	Command(clprelpath) timeout.	Failed in operation, because timeout has occurred in executing the command (clprelpath).	System is highly loaded. Take the cause of high load off.
Error	Command(mount) return error.	Failed in operation, because an error occurred in executing the mount command.	Make sure that mount option of mirror resource is properly configured.  Make sure that mount option that is supported by file system is configured.  Make sure that the directory of mount point of the mirror resource exists.
Error	Command(umount) return error.	Failed in operation, because an error occurred in executing the <code>umount</code> command.	Make sure that the directory of mount point of the mirror resource exists.
Error	Command(fsck) return error.	Failed in operation, because an error occurred in executing the <code>fsck</code> command.	Make sure that fsck option of mirror resource is properly configured.  Make sure that the <code>fsck</code> option supported by file system exists.
Error	Mirror disk is busy in activate.	Failed in operation, because the mirror disk is now being activated.	Click <b>Reload</b> to display the latest status of a cluster, and try again.
Error	Failed to get the diff bitmap of mirror disk.	Failed to acquire the difference information of mirror disk from the mirror agent.	Make sure that the setting value related to the mirror disk is not wrong.  Shut down and reboot a cluster.
Error	Failed to get the device size of mirror disk.	Failed in operation, because acquiring the device size of mirror disk failed.	Make sure that mirror disk setting (especially in data partition) does not contain any error.



Level	Message	Cause	Solution
Error	Failed to start the cluster "{0}". Click the Reload button, or try again later.	The status of a cluster may not be the latest.  The status of the cluster when being operated from another WebManager or by the <code>clpctl</code> command may not be applied on the display.  The name of the cluster is displayed where {0} is represented.	Click <b>Reload</b> to display the latest status of a cluster, and try again.
Error	Failed to stop the cluster "{0}". Click the Reload button, or try again later.	The status of a cluster may not be the latest.  The status of the cluster when being operated from another WebManager or by the <code>clpctl</code> command may not be applied on the display.  The name of the cluster is displayed where {0} is represented.	Click <b>Reload</b> to display the latest status of a cluster, and try again.
Error	Failed to suspend the cluster "{0}". Click the Reload button, or try again later.	The status of a cluster may not be the latest.  The status of the cluster when being operated from another WebManager or by the <code>clpctl</code> command may not be applied on the display.  The name of the cluster is displayed where {0} is represented.	Click <b>Reload</b> to display the latest status of a cluster, and try again.
Error	Failed to resume the cluster "{0}". Click the Reload button, or try again later.	The status of a cluster may not be the latest.  The status of the cluster at when being operated from another WebManager or by the <code>clpctl</code> command may not be applied on the display.  The name of the cluster is displayed where {0} is represented.	Click <b>Reload</b> to display the latest status of a cluster, and try again.
Error	Failed to restart the manager service. Click the Reload button, or try again later.	An error occurred on the data transfer server of EXPRESSCLUSTER.	Check the status of the data transfer server of EXPRESSCLUSTER.

Level	Message	Cause	Solution
Error	Failed to start the server "{0}". Click the Reload button, or try again later.	The status of a cluster may not be the latest.  The status of cluster at when the cluster is operated from other WebManager, or the status of server is changed may not be applied.  The name of the server is displayed where {0} is represented.	Click <b>Reload</b> to display the latest status of a cluster, and try again.
Error	Failed to stop the server "{0}". Click the Reload button, or try again later.	The status of a cluster may not be the latest.  The status of cluster at when the cluster is operated from other WebManager, or the status of server is changed may not be applied.  The name of the server is displayed where {0} is represented.	Click <b>Reload</b> to display the latest status of a cluster, and try again.
Error	Failed to start group "{0}" at server "{1}".	The status of a group may not be the latest.  It may be that the status of cluster has been altered from a different WebManager or by a <code>clpgrp</code> command, but the display has not yet reflected these changes.  The name of the group is displayed where {0} is represented.	Click <b>Reload</b> to display the latest status of a group, and try again.
Error	Failed to stop group "{0}".	The status of a group may not be the latest.  It may be that the status of cluster has been altered from a different WebManager or by a <code>clpgrp</code> command, but the display has not yet reflected these changes.  The name of the group is displayed where {0} is represented.	Click <b>Reload</b> to display the latest status of a group, and try again.

Level	Message	Cause	Solution
Error	Failed to migrate group "{0}" to server "{1}".	<p>The status of a group may not be the latest.</p> <p>It may be that the status of cluster has been altered from a different WebManager or by a <code>clpgrp</code> command, but the display has not yet reflected these changes.</p> <p>The name of the group is displayed where {0} is represented.</p>	Click <b>Reload</b> to display the latest status of a group, and try again.
Error	Failed to suspend the monitor "{0}". Click the Reload button, or try again later.	<p>The status of a cluster may not be the latest.</p> <p>The status of the cluster when being operated from another WebManager or by the <code>clpmonctrl</code> command may not be applied on the display.</p> <p>The name of the monitor resource is displayed where {0} is represented.</p>	Click <b>Reload</b> to display the latest status of a cluster, and try again.
Error	Failed to resume the monitor "{0}". Click the Reload button, or try again later.	<p>The status of a cluster may not be the latest.</p> <p>The status of the cluster when being operated from another WebManager or by the <code>clpmonctrl</code> command may not be applied on the display.</p> <p>The name of the monitor resource is displayed where {0} is represented.</p>	Click <b>Reload</b> to display the latest status of a cluster, and try again.
Error	Failed to suspend the monitor. Click the Reload button, or try again later.	<p>The status of a cluster may not be the latest.</p> <p>The status of the cluster when being operated from another WebManager or by the <code>clpmonctrl</code> command may not be applied on the display.</p>	Click <b>Reload</b> to display the latest status of a cluster, and try again.
Error	Failed to resume the monitor. Click the Reload button, or try again later.	<p>The status of a cluster may not be the latest.</p> <p>The status of the cluster when being operated from another WebManager or by the <code>clpmonctrl</code> command may not be applied on the display.</p>	Click <b>Reload</b> to display the latest status of a cluster, and try again.

Level	Message	Cause	Solution
Error	Failed to update the data in real time. Trying to connect to the server again.	Connection may have already reached the maximum number.	Change the setting on <b>IP Addresses of the Accessible Client</b> of WebManager.  Terminate the unneeded WebManager.
Error	Failed to start the resource "{0}". Click the Reload button, or try again later.	The status of a cluster may not be the latest.  The status of the cluster when being operated from another WebManager may not be applied on the display.  The name of the resource is displayed where {0} is represented.	Click <b>Reload</b> to display the latest status of a cluster, and try again.
Error	Failed to stop the resource "{0}". Click the Reload button, or try again later.	The status of a cluster may not be the latest.  The status of the cluster when being operated from another WebManager may not be applied on the display.  The name of the monitor resource is displayed where {0} is represented.	Click <b>Reload</b> to display the latest status of a cluster, and try again.
Error	Failed to suspend any monitor. Click the Reload button, or try again later.	The status of a cluster may not be the latest.  The status of the cluster when being operated from another WebManager or by the <code>clpmonctrl</code> command may not be applied on the display.	Click <b>Reload</b> to display the latest status of a cluster, and try again.
Error	Failed to resume any monitor. Click the Reload button, or try again later.	The status of a cluster may not be the latest.  The status of the cluster when being operated from another WebManager or by the <code>clpmonctrl</code> command may not be applied on the display.	Click <b>Reload</b> to display the latest status of a cluster, and try again.
Error	Failed to disable dummy failure of monitors. Click the Reload button, or try again later.	The status of a cluster may not be the latest.  The status of the cluster when being operated from another WebManager or by the <code>clpmonctrl</code> command may not be applied on the display.	Click <b>Reload</b> to display the latest status of a cluster, and try again.

Level	Message	Cause	Solution
Error	Failed to disable a part of dummy failure of monitors. Click the Reload button, or try again later.	The status of a cluster may not be the latest. The status of the cluster when being operated from another WebManager or by the <code>clpmonctrl</code> command may not be applied on the display.	Click <b>Reload</b> to display the latest status of a cluster, and try again.
Error	Failed to disable dummy failure of monitor "{0}". Click the Reload button, or try again later.	The status of a cluster may not be the latest. The status of the cluster when being operated from another WebManager or by the <code>clpmonctrl</code> command may not be applied on the display.	Click <b>Reload</b> to display the latest status of a cluster, and try again.
Error	Failed to start mdagent. Click the Reload button, or try again later.	EXPRESSCLUSTER daemon is not started. The status of the cluster when being operated from another WebManager or by the <code>clpcl</code> command may not be applied on the display.	Make sure the EXPRESSCLUSTER daemon of each server is up and running. Click <b>Reload</b> to display the latest status of a cluster, and try again.
Error	Failed to stop mdagent. Click the Reload button, or try again later.	The status of the cluster when being operated from another WebManager or by the <code>clpcl</code> command may not be applied on the display.	Click <b>Reload</b> to display the latest status of a cluster, and try again.
Error	Could not start the group because it has recovering mirror disk. Try again after mirror recovery is completed.	Starting failover group will be stopped because there is a mirror disk resource processing mirror recovery on the failover group.	Perform the same operation after mirror recovery is completed.
Error	Could not move the group because it has recovering mirror disk. Try again after mirror recovery is completed.	Moving failover group will be stopped because there is a mirror disk resource processing mirror recovery on the failover group.	Perform the same operation after mirror recovery is completed.
Error	Could not start the mirror disk because it is recovering now. Try again after mirror recovery is completed.	Starting a resource will be stopped because the mirror disk resource is processing mirror recovery.	Perform the same operation after mirror recovery is completed.

Level	Message	Cause	Solution
Error	An internal error occurred.	A memory shortage, network error, file system capacity shortage or other OS resource shortage occurred on the server where the WebManager is connected to.	Make sure that there is enough space of OS resource, network or file system in the server.
Error	Mirror Agent service is not running.	Mirror agent daemon is not started.	Start the mirror agent daemon, and then try it again.
Error	The operation timeout period has expired.	Timeout has occurred when the WebManager is collecting data from the mirror agent.	The system is highly loaded. Take the cause of high load off.  When the system is temporarily in high load, change the ratio of timeout using the <code>clptoratio</code> command.
Error	Because server "{0}" has I/O error in accessing cluster partition, the action you selected cannot be executed. Please select another server.	The I/O error has occurred in connecting the cluster partition at the server; {1}.	- Select the other server. - Check the shared disk.
Error	Because server "{0}" has I/O error in accessing cluster partition, the action you selected cannot be executed. Please select another server.	The I/O error has occurred in connecting the cluster data partition at the server; {1}.	Select the other server. - Check the shared disk.
Warning	The mirror disk list data may have not been fully obtained from the server.	An error has occurred in acquiring the failed mirror disk list data.	Check to see the status of mirror disk agent, and then, perform the reload.
Error	Failed to start mdagent.  Check the cluster and mdagent status.  Click the Reload button, or try again later.	EXPRESSCLUSTER daemon/mirror agent is already started.  The status of the cluster when being operated from another WebManager or by the <code>clpcl</code> command may not be applied on the display.	Check to see the status of the cluster and mirror disk agent.  Click <b>Reload</b> to display the latest status of a cluster, and try again.
Error	Failed to stop mdagent.  Check the cluster status.  Click the Reload button, or try again later.	The EXPRESSCLUSTER daemon is up and running.  The status of the cluster when being operated from another WebManager or by the <code>clpcl</code> command may not be applied on the display.	Check to see the status of the cluster and mirror disk agent.  Click <b>Reload</b> to display the latest status of a cluster, and try again.

Level	Message	Cause	Solution
Error	Failed to change to current server.	Failed to change the current right.	Check to see the status of the mirror agent. Click <b>Reload</b> to display the latest status of a cluster, and try again.
Error	Cannot get the current server information.	An error has occurred in acquiring the current server information.	Check to see the status of mirror agent, and try again.
Error	This server is not current server. Cannot perform this action.	The server you specified is not the current server.	Click <b>Reload</b> to display the latest status of a cluster, and try again.
Error	A server is changing the current server. This action cannot be performed.	A server is changing the current server.	Wait for a while, and try again.
Error	Not connected to the server now. The settings will be displayed when the connection recovers. Wait for a moment.	Failed to communicate with WebManager.	Make sure that the EXPRESSCLUSTER Web Alert service is running on the server side. Make sure that it can normally connect to a server.
Error	Failed to get the license information.	Failed to obtain the license information.	Check to see the license. Shut down and then reboot the cluster.
Error	The license information obtained from the server may be incomplete.	Part of the license information could not be obtained.	Check to see the license. Shut down and then reboot the cluster.
Error	The request to resume the cluster failed on some servers.	Some servers failed to resume the clusters.	Check the status of the server which failed to resume the clusters.
Error	Failed to get the time info from the server.	The time information could not be obtained.	Click <b>Reload</b> to display the latest status of a cluster, and then reexecute the same operation.
Error	Failed to clear the time info.	Failed to clear the time information.	Click <b>Reload</b> to display the latest status of a cluster, and then reexecute the same operation.





# Chapter 2      Functions of the Builder

This chapter provides information on functions of the EXPRESSCLUSTER X Builder.

This chapter covers:

- Overview of the Builder ..... 142
- Details on the Builder screen ..... 145
- Pop-up menu..... 152
- Using a tool bar of the Builder ..... 153
- Using the menu bar of the Builder..... 154
- File menu ..... 154
- View menu ..... 164
- Edit menu ..... 165
- Help Menu ..... 168
- Parameter details ..... 169
- Cluster properties..... 169
- Server properties..... 229
- Functional differences of the Builder between Linux and Windows..... 241
- Parameters list ..... 242
- Upper limits of registration..... 294

## Overview of the Builder

The EXPRESSCLUSTER X Builder is a tool for creating and changing the cluster configuration data (config and scripts).

There are two versions of the Builder; online version and offline version.

- ◆ Online version

Click **Config Mode** on the **View** menu or select the config mode icon  from the dropdown menu on the toolbar.

With the online version Builder, you can connect to the server directly to create a cluster, change its configuration and distribute the cluster configuration data.

- ◆ Offline version

With the offline version Builder, you can create or change the cluster configuration data on the machine which cannot connect to a server.

To distribute the cluster configuration data, you need to use the `clpcfctrl` command.

---

**Note:**

In this document, *Builder* refers to the online version of Builder, which runs in the WebManager config mode, and the offline version of Builder, which runs on the management PC.

“Linux version” in this guide represents the Builder that runs on the Linux browser. “Windows version” represents the Builder that runs on the Windows browser. “Host name” in this guide represents the short name that excludes the domain name from a frequently qualified domain name (FQDN).

---

## Considerations for using the Builder

- ◆ The following products' cluster configuration data is not compatible.  
The Builder of other than the EXPRESSCLUSTER X 3.3 for Linux
- ◆ Cluster configuration data created using a later version of this product cannot be used with this product.
- ◆ Cluster configuration data of EXPRESSCLUSTER X1.0/2.0/2.1/3.0/3.1/3.2/3.3 for Linux can be used with this product.  
You can use such data by clicking **Import** from the **File** menu in the Builder.
- ◆ If you close the Web browser (by clicking **Exit** from the **File** menu or clicking **X** at the top right-hand corner of the window frame), the dialog box to confirm to save is displayed.



Are you sure you want to navigate away from this page?

The settings that have not been applied will be destroyed.

Press OK to continue, or Cancel to stay on the current page.



When you continue to edit, click the **Cancel** button.

---

### Note:

This dialog box is not displayed if JavaScript is disabled.

---

- ◆ If you reload data on the Web browser (by selecting **Reload** from the **Tool** menu or clicking reload icon on the toolbar), the dialog box to confirm to save is displayed.



Are you sure you want to navigate away from this page?

The settings that have not been applied will be destroyed.

Press OK to continue, or Cancel to stay on the current page.



When you continue to edit, click the **Cancel** button.

---

### Note:

This dialog box is not displayed if JavaScript is disabled.

---

- ◆ Do not specify a number smaller than 30 seconds for **Reload Interval** in the **WebManager** tab (See “WebManager tab” on page 206 for details). If you have to set a smaller number for this field than the default value, test thoroughly to see if it works properly before you start the operation.
- ◆ When creating the cluster configuration data using the Builder, do not enter the value starting with 0 on the text box. For example, if you want to set 10 seconds for a timeout value, enter “10” but not “010.”

## Limitations on using the Builder

- ◆ If you change the screen resolution while the Builder is running, the Java VM stack trace (example: NullPointerException) may be logged on the Java console. The Builder can keep running.
- ◆ If you press **Esc** while a pull-down menu of your browser is displayed, the Java VM stack trace (example: NullPointerException) may be logged on the Java console. The Builder can keep running.
- ◆ In some cases, you cannot use the keyboard because the keyboard focus of the Builder becomes disabled (the focus changes to the Web browser). Click the Builder window and get the focus back to the Builder.
- ◆ When you are using the multi-display function, do not run the Builder on the secondary display. Otherwise, it may not work properly. For example, the screen is not displayed. Use the Builder on the primary display.
- ◆ When using the browser on Linux, depending on the combination with the Window Manager, the dialog may be placed behind other windows. Switch the window with **ALT + TAB**.
- ◆ When opening or saving the cluster configuration data on Linux, general users cannot use a 1.44MB FAT (VFAT) formatted floppy disk. If you want to handle the cluster configuration data on the Builder running on the Windows Web browser as well, log on as a root user.
- ◆ On the **Alert Log** tab (see “Alert Log tab” on page 212), for **Max. Number to Save Alert Records**, if you set a number smaller than the current one, all alert logs will be deleted. Take into account the available disk space, and specify the number before you start the operation.
- ◆ In the environment where Internet Explorer is used, disable **Protected Mode** on the security setting of Internet Explorer.
- ◆ The JIS 2004-unique characters supported by Microsoft Windows Vista® are not supported. Thus, you cannot enter or view the characters added by JIS 2004.
- ◆ The Builder does not run normally through the Reverse Proxy server.
- ◆ The mnemonic key may not work normally when Java™ Runtime Environment Version 7.0 Update2 (1.7.0\_2) or later is being used.

## Details on the Builder screen

This topic explains the Builder screen layout.

### Overview of the EXPRESSCLUSTER X Builder

The screen layout of the Builder is displayed below.

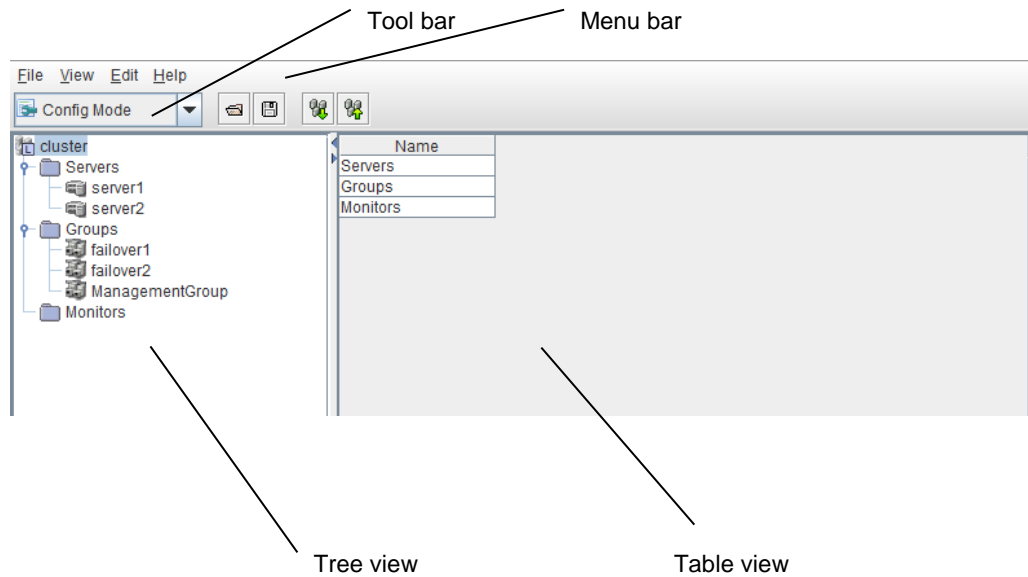

The tree view on the left pane shows the cluster objects in the hierarchical order. If you select an object from the tree view, its subordinate objects are displayed in the table view on the right

### Tree view

The following objects are displayed in the tree view:

Hierarchy	Object	Contents	Table view when the object is selected
1	cluster	Represents the cluster.	Displays cluster names.
2	Servers	Represents a set of servers in the clusters	Displays servers.
3	server1 server2	Represents each server	Displays server names.
2	Groups	Represents a set of groups in the clusters	Displays groups.
3	failover1 failover2 ManagementGroup	Represents each group.	Displays group names.
2	Monitors	Represents a set of monitor resources in the clusters	Displays monitors.

## Table view

### Table for cluster name selection

Displays objects under the root hierarchy.

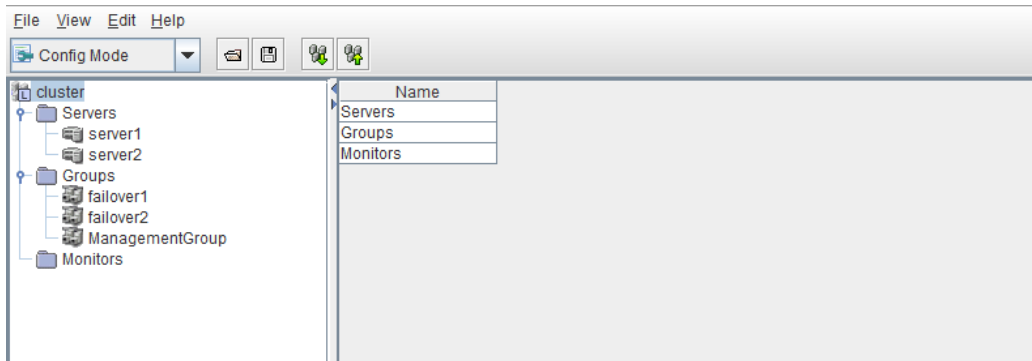

### Table for server selection

Displays the list of servers.

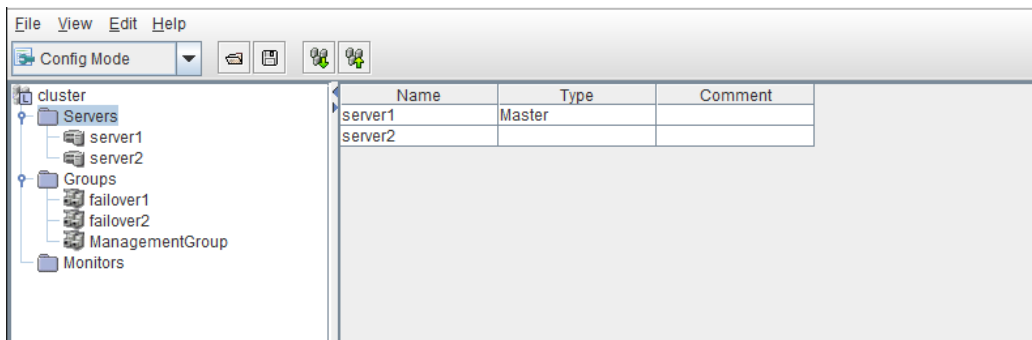

Column name	Overview
Name	Displays server names in alphanumerical order.
Type	If the server is specified as the master server, "Master" is displayed.
Comment	Displays comments specified for the server.

## Table for server name selection

Displays the list of groups allowed to start on the selected server.

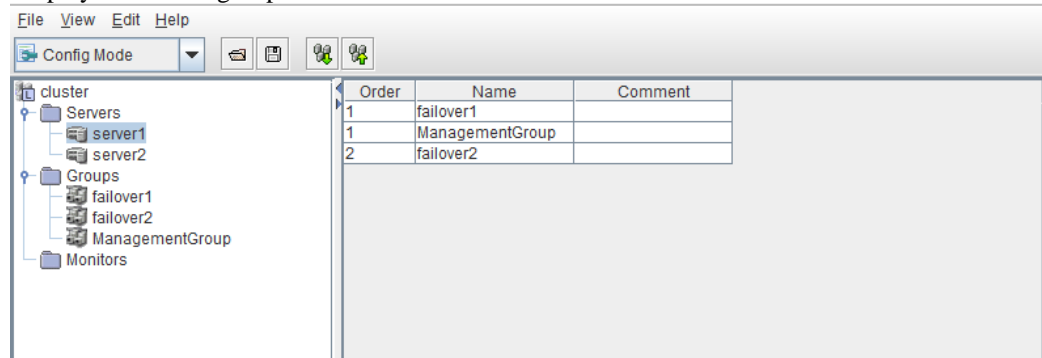

Column name	Overview
Order	Displays the server priority. The groups in the name cells start on servers in this order. “1” is displayed for the top priority. This list is displayed in the descending order of priority.
Name	Displays the group name.
Comment	Displays comments specified for the group.

## Table for group selection

### Group list

Displays the failover priorities of the groups.

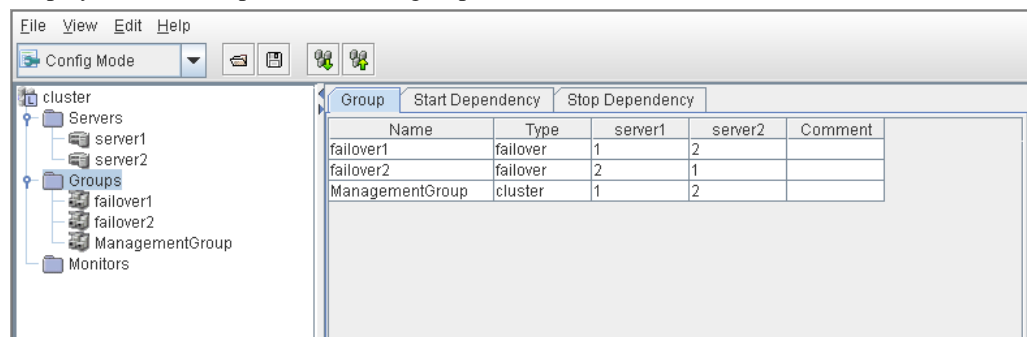

Column name	Overview
Name	Displays the group names in alphanumerical order.
Type	Displays the group type.
Server names (The number of columns dynamically increases or decreases according to the number of servers)	Represents the startup order of groups on the servers displayed by column names. The top priority is represented with “1.”
Comment	Displays comments specified for the groups.

**Start dependence**

The dependencies included in the group start dependence are listed.

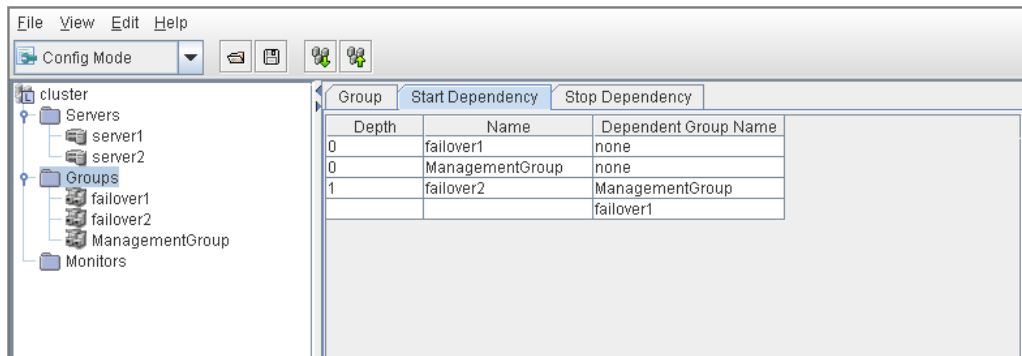

Column name	Overview
Depth	Represents the target start order of groups in the name cells. If start dependence is not applied to any group, "0" is displayed. Groups are displayed in the depth order.
Name	Displays group names.
Dependent Group Name	Displays the group start dependence names in the name cells. If start dependence is not applied to any group, "none" is displayed. If there are multiple start dependence groups, they are displayed on separate rows.

The levels of depth are illustrated below. Arrows (->) in the figure represent group start dependence targets.

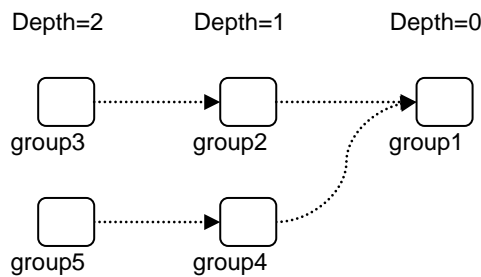

The dependencies represented by this figure are listed below.

Depth	Name	Start dependence group name
0	Group1	None
1	Group2	group1
1	Group4	group1
2	Group3	group2
2	Group5	group4



### Stop dependence

The dependencies included in the group stop dependence are listed.

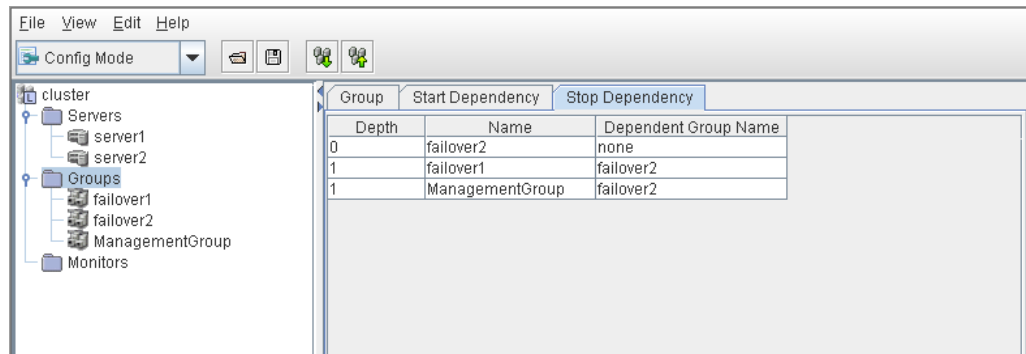

Column name	Overview
Depth	Represents the target stop order of groups in the name cells. If stop dependence is not applied to any group, "0" is displayed. Groups are displayed in the depth order.
Name	Displays group names.
Dependent Group Name	Displays the group stop dependence names in the name cells. If stop dependence is not applied to any group, "none" is displayed. If there are multiple stop dependence groups, they are displayed on separate rows.

The levels of depth are illustrated below. Arrows (->) in the figure represent group stop dependence targets.

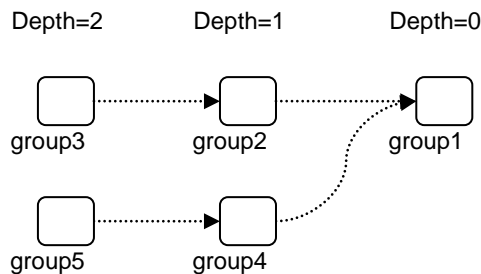

The dependencies represented by this figure are listed below.

Depth	Name	Stop dependence group name
0	group1	none
1	group2	group1
1	group4	group1
2	group3	group2
2	group5	group4

## Table for group name selection

### Resources

Group resources in the selected group are listed.

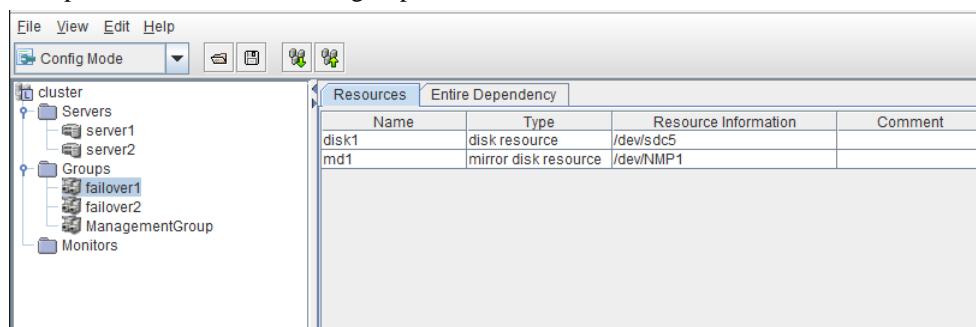

Column name	Overview
Name	Displays group resource names in alphanumerical order.
Type	Displays a group resource type.
Resource Information	Displays objects to be activated or deactivated for the group resource.
Comment	Displays comments specified for the group resource.

### Dependency List

Dependency among group resources in a selected group is listed.

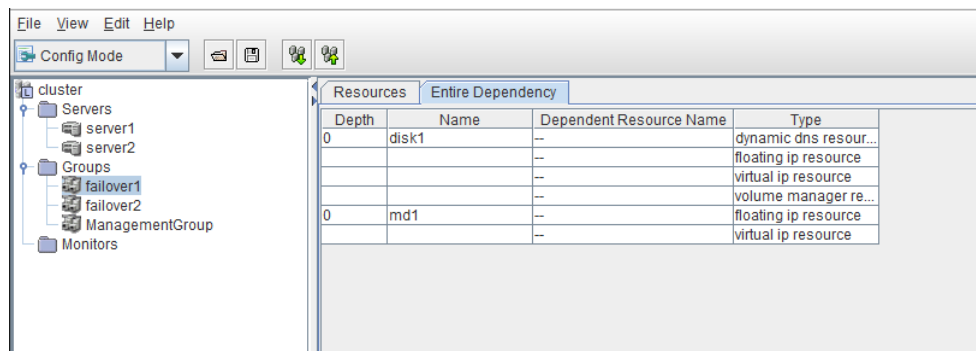

Column name	Overview
Depth	Represents the target activation order of group resources in the name cells. If a group resource does not depend on any group resource, "0" is displayed. Group resources are displayed in the depth order.
Name	Displays the group resource name.
Dependent Resource Name	Displays the group resource names that the group resources in the name cells depend on. If a group resource does not depend on any group resource, "none" is displayed. When following the default dependency, "--" is displayed. If there are multiple dependent resources, they are displayed in separate rows.
Type	Displays the group resource type in Dependent Resource Name. When following the default dependency, the dependent type is displayed.

The levels of depth are illustrated below. Arrows (->) in the figure represent the group resource activation order.

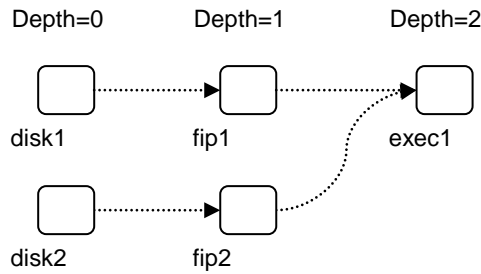

The dependencies in this figure are listed below. These are not the default dependencies, but specified with resource names.

Depth	Name	Dependent Resource Name	Type
0	disk1	none	
0	disk2	none	
1	fip1	disk1	disk resource
1	fip2	disk2	disk resource
2	exec1	fip1	floating ip resource
		fip2	floating ip resource

### Table for monitor resource selection



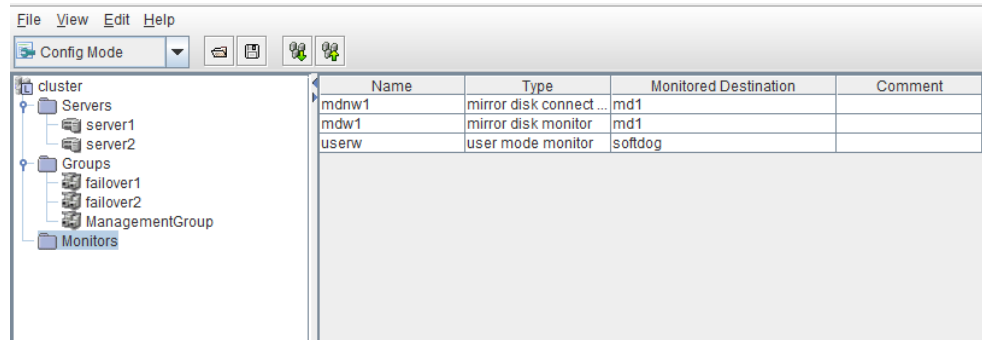



Displays the list of monitor resources.



Column name	Overview
Name	Displays monitor resource names in alphanumerical order.
Type	Displays the monitor resource type.
Monitored Destination	Displays the monitor resource to be monitored.
Comment	Displays comments specified for the monitor resource.

## Pop-up menu

Pop-up menus are displayed by right-clicking a tree object or table row.

If select	Displayed menu	Refer to
 <i>no_cluster_name</i>	Cluster Generation Wizard	Creating a new cluster (on page 155)
 <i>cluster_name</i>	Remove Cluster	Removing an object(on page 166)
	Rename Cluster	Renaming an object (on page 167)
	Properties	Properties (on page 167)
 Servers	Server Definition	Adding an object (on page 165)
	Properties	Properties (on page 167)
 <i>server_name</i>	Remove Server	Removing an object(on page 166)
	Rename Server	Renaming an object (on page 167)
	Properties	Properties (on page 167)
 Monitor Resources	Add monitor resource	Adding an object (on page 165)
 Groups	Add Group	Adding an object (on page 165)
	Add Group for WebManager	Chapter 5 “Creating the cluster configuration data” in the <i>Installation and Configuration Guide</i>
 <i>group_name</i>	Add Resource	Adding an object (on page 165)
	Remove Group	Removing an object(on page 166)
	Rename Group	Renaming an object (on page 167)
	Properties	Properties (on page 167)
<i>group_resource_name</i>	Remove Resource	Removing an object(on page 166)
	Rename Resource	Renaming an object (on page 167)
	Properties	Properties (on page 167)
<i>monitor_resource_name</i>	Remove Monitor Resource	Removing an object(on page 166)
	Rename Monitor Resource	Renaming an object (on page 167)
	Properties	Properties (on page 167)





## Using a tool bar of the Builder

The Builder provides a toolbar:



For details about the icons used to switch to the operation mode, the config mode, or the reference mode, which are common to the WebManager, see the WebManager windows in Chapter 1, “Functions of the WebManager” in this guide.

If you click the combo box and icons on the toolbar specific to the Builder screen, you can perform the same operations as some functions of the pull-down menu displayed on the top of the screen.

Button	Function	Refer to
	Opens a file. This is the same as clicking <b>File</b> on the menu bar and then selecting <b>Open</b> .	“Opening the configuration file” (on page 155)
	Saves a file. This is the same as clicking <b>File</b> on the menu bar and then selecting <b>Save</b> .	“Saving the configuration file” (on page 156)
	Get the configuration. This is the same as clicking <b>Download the Configuration File</b> on the <b>File</b> menu.	“Get the configuration file (online version only)” (on Page 157)
	Apply the configuration. This is the same as clicking <b>Upload the Configuration File</b> on the <b>File</b> menu.	“Apply the configuration file (online version only)” (on Page 158)

## Using the menu bar of the Builder

You can perform various operations by using the menu bar of the Builder. This topic explains the operations to be executed using the menu bar.

### File menu

Select **File** to display the following menu.

Menu	Functional overview
New File	Creates a cluster.
Cluster Generation Wizard	Opens the cluster generation wizard.
Import	Read the cluster configuration information file.
Export	Save the configuration information as the cluster configuration information file.
Get the Configuration File	Connect to the cluster and get the current configuration information (online version only).
Apply the Configuration File	Apply the configuration information to the cluster (online version only).
Update Server Data	Update the server IP address and the device information (online version only).
Option	Starts the Option dialog box.
Save log files	Starts the Save Logs dialog box.
Exit	Exits the Builder.

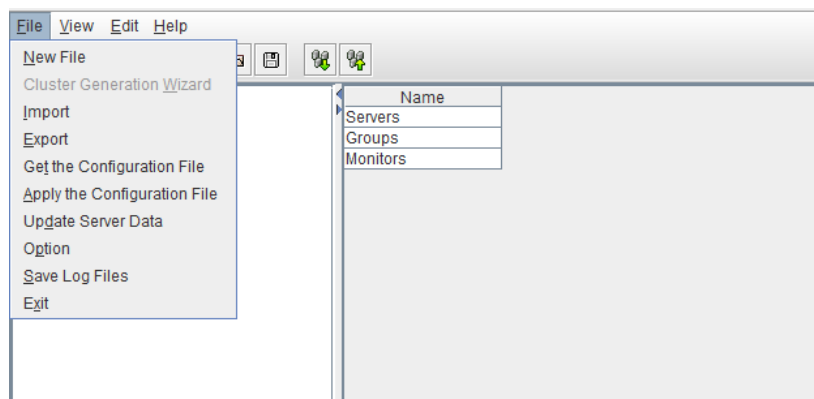

## Creating a new cluster

Create a new cluster using the Builder.

---

### Important:

If you create a new cluster, the cluster configuration data that has been edited will be discarded. Be sure to save the required data before you create a new cluster.

---

1. On the menu bar, click **File** and then click **Create New File**.
2. If you made changes in the cluster configuration data, a dialog box asks if you want to save them before they are discarded. Click **Yes** to save the changes. A dialog where you can specify a folder to save the cluster configuration data is displayed. If you do not want to save the changes, click **No**. For how to save the data, see “Saving the configuration file” on page 156.
3. Right-click the cluster icon on the tree view on the left pane, click **Cluster Generation Wizard** to create a cluster using a wizard.

For details about the cluster generation wizard, refer to Chapter 5, “Creating the cluster configuration data” in the *Installation and Configuration Guide*.

## Opening the configuration file

Select **Import** to open the saved cluster configuration data. A tree view is displayed by the configuration file that has been read.

Select this to restart editing a temporary file saved while editing the configuration data.

### How to use:

- ◆ For Linux

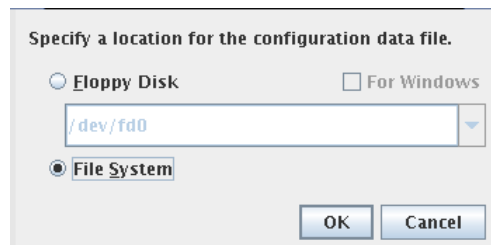

### Floppy Disk

If your floppy disk contains the cluster configuration data, select **Floppy Disk**. Select the floppy disk device from the combo box. If you cannot find it in the combo box, type the device path.

### For Windows

This is enabled when **Floppy Disk** is selected. To open a cluster configuration data that was made by the Builder running on the Windows browser, select **For Windows**.

This function is available only for root users.

The Builder mounts or unmounts the floppy disk.

### File System

Select this to read a cluster configuration data temporarily saved on the file system. Click **OK** to move to the “For Windows” screen.

- ◆ For Windows

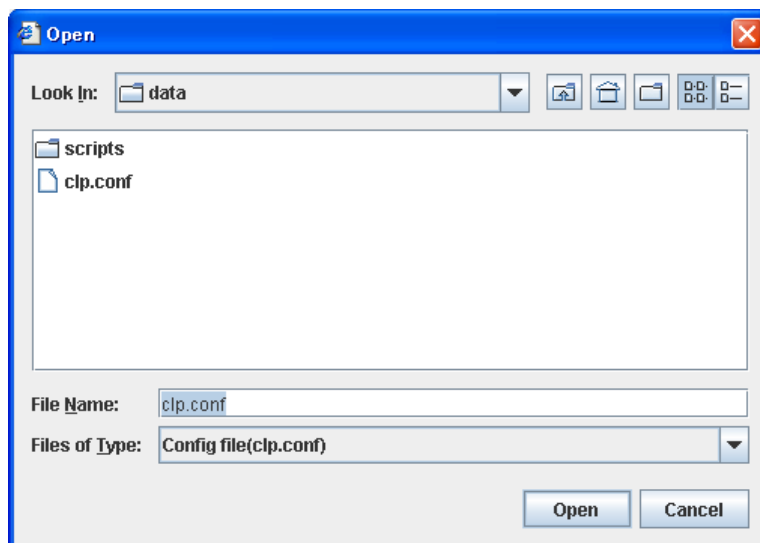

For **File Name**, select or type “clp.conf.”

## Saving the configuration file

Click **Export** to save the cluster configuration data you are editing. This menu becomes available if you have created a cluster configuration data. Save the file as “clp.conf.”

To save a cluster configuration data, the following conditions should be satisfied.

- ◆ The server exists.
- ◆ LAN heartbeat resource or kernel-mode LAN heartbeat resource exists.

### How to use:

- ◆ For Linux

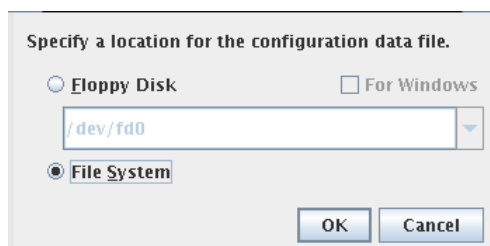

#### Floppy Disk

To save the cluster configuration data in a floppy disk, click **Floppy Disk**. Select the floppy disk device from the combo box. If you cannot find it in the combo box, type the device path.

#### For Windows

This is enabled when **Floppy Disk** is selected. If you want to edit the data also by the Builder running on the Windows browser, select **For Windows**. This function is available only for root users. The Builder mounts or unmounts a floppy disk. Prepare a Windows FAT (VFAT)-format 1.44-MB floppy disk.



### File System

Select this to save the cluster configuration data on the file system. Click **OK** to move to the “For Windows” screen.

---

#### Note:

When using Builder on the server on which EXPRESSCLUSTER is operated, do not edit `/opt/nec/clusterpro/etc/clp.conf` on the server directory. Otherwise, messages regarding how to apply the changes are not properly displayed, and/or EXPRESSCLUSTER may not work properly. Save the file on a different directory temporarily.

When uploading is performed by using the `clpcfctrl` command, specify the directory where the file is saved by using the `-x` option.

---

#### ◆ For Windows

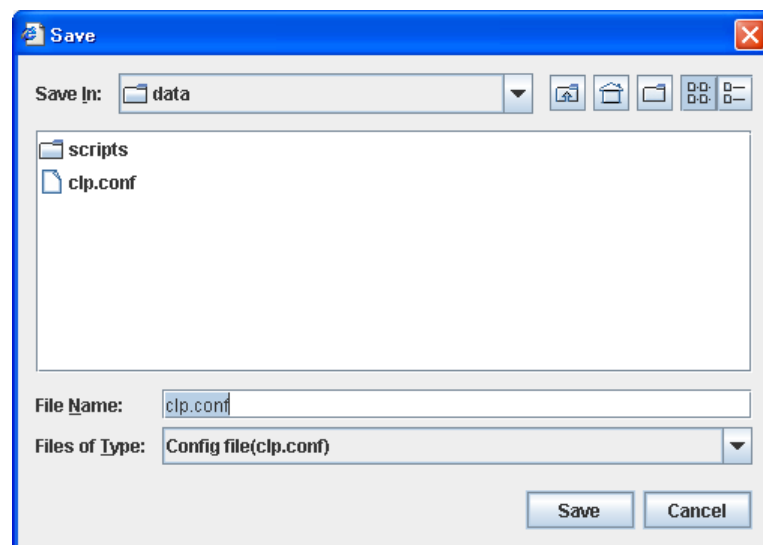

For **File Name**, select or type “clp.conf”. The server reads this file by “clp.conf”.

## Get the configuration file (online version only)

Get the cluster configuration file from the cluster server. The tree view is displayed according to the configuration file,

If any changes have been made in the data which is being edited, a dialog box that asks if you want to save the data is displayed.

Click **Yes** to save the changes. A dialog where you can specify a folder to save the cluster configuration data is displayed. For how to save the data, see “Saving the configuration file” on page 156.

If you do not need to save the changes, click **No**. The cluster configuration that is being edited is discarded and Builder gets the configuration file from the cluster server.

If you want to cancel getting, click **Cancel**.

## Apply the configuration file (online version only)

Apply the cluster configuration data that is being edited to the connected server. You can select this menu when you open a valid cluster configuration file.

The following conditions must be satisfied to apply the configuration file.

- ◆ The EXPRESSCLUSTER data transfer (clusterpro\_trn) in all the servers in the cluster is properly operated.
- ◆ A LAN heartbeat resource or kernel mode LAN heartbeat resource is configured.

---

### Note:

If this condition is not met, connecting to other server fails, so applying the cluster configuration data fails. In this case, you can only apply the cluster configuration data to a server that can be connected to. For details, see “Creating a cluster and backing up configuration data (clpcfctrl command)” in Chapter 3 “EXPRESSCLUSTER command reference” in this guide.

---

The following message is displayed while applying the cluster configuration data. If the applying the data fails, take an action according to the error message, and apply the data again.

Message	Solution
The application finished successfully.	-
Changes applied successfully. Some services have been stopped in order to apply the changes. Use the following steps to resume the stopped services.  <Necessary steps>  Execute now?	If you select <b>Yes</b> , the steps will be executed.
The apply was stopped. Applying the cluster configuration file failed in one or more servers.	Since the resource whose settings have been changed has not been stopped, applying the cluster configuration data has been canceled. Stop the resource whose settings have been changed, and then apply the data again.
The apply was stopped. There is one or more servers that cannot be connected to. To apply cluster configuration information forcibly, run the clpcfctrl command on the server.	Since there is a server that cannot be connected to exist in the cluster, applying the cluster configuration data has been canceled. Make sure that all the servers in the cluster have been started, and then apply the cluster configuration data. If you want to apply the cluster configuration data forcibly even though there is a server that cannot be connected in the cluster, see “Creating a cluster and backing up configuration data (clpcfctrl command)” in Chapter 3 “EXPRESSCLUSTER command reference” in this guide.
An error occurred when applying data to the cluster. Cfctrl (%0)	Since an error has occurred while performing processing, applying the cluster configuration data has been canceled. Apply the data again.

Message	Solution
Checking the cluster configuration file failed. Check the following settings. Server Name, IP address for interconnect, IP address for Integrated WebManager	There are differences between the IP addresses included in the cluster configuration information and the IP addresses currently set to each server. Check correct IP addresses are set or not.

**Related Information:**

If a server that cannot be connected to exists in the cluster, the cluster configuration data cannot be applied from the Builder. In this case, by running the `clpcfctrl` command, you can forcibly apply the cluster configuration data only on the server that can be connected to.

Follow the steps below to forcibly apply the cluster configuration data.

- (1) Save the cluster configuration data to an appropriate directory of the local disk from the Builder.

Example) Save the configuration data to C:\config

- (2) Save the cluster configuration data that you have saved on a server in the cluster.

Example) Save the data in C:\config that you have saved in step (1) in the `/root/tmp` directory on a server in the cluster.

- (3) Run the following command on the server where the cluster configuration data has been saved.

```
clpcfctrl --push -w -x "Directory where the cluster configuration data has been saved" --force
```

Example) Run the following command on the server where step (2) has been performed.

```
clpcfctrl --push -w -x "/root/tmp" --force
```

## Update Server Data (online version)

Get the information of the specified server.

The license information is also obtained when getting the IP list or device information. If the license for Java Resource Agent is registered, the **JVM monitor** tab will appear in **Cluster Properties**. You will be able to create resources and monitor resources corresponding to the registered licenses.

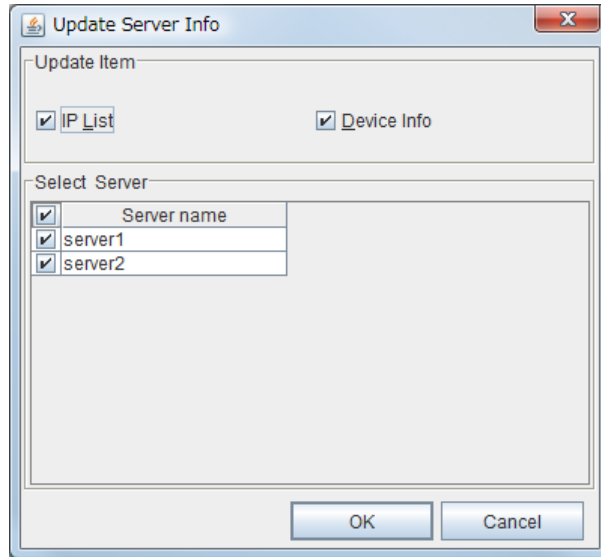

### Update Item

- ◆ IP List  
Get the IP address list.
- ◆ Device Info  
Get the device information of disk and COM.

---

### Note:

The device information for the disk managed with GPT cannot be acquired.

---

### Select Server

Specify the servers from which the information is gotten. By clicking the check box on the table title, the status of all the server check box can be changed at once.

## Changing communication settings

Select **Option** and then click the **Online** tab to change settings for server communications. These settings are not recognized in the offline version.

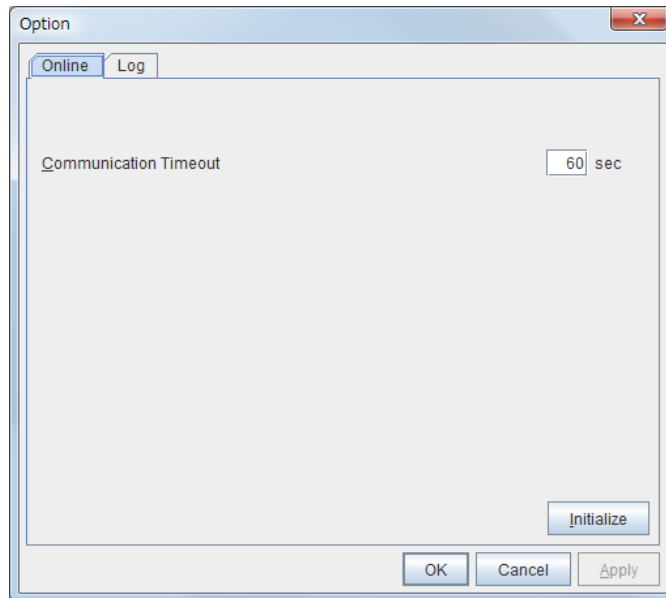

### **Communication Timeout (0 to 999)**

This is the time-out value when accessing a server.

## Changing the log level settings of Builder

Select **Option** and then click the **Log** tab to change the Builder log level.

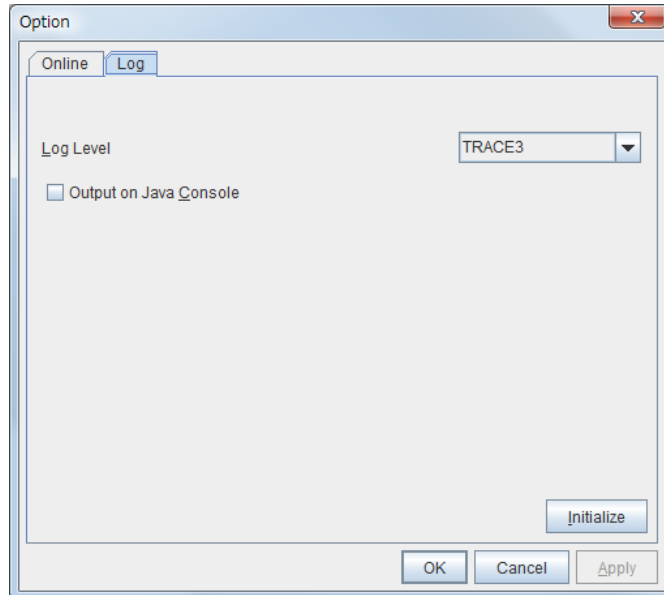

### Log Level

Configures the level of internal logs that Builder produces during operation.

- **ERROR**  
Select this to read only error-level logs.
- **WARNING**  
Select this to read warning-level and error-level logs.
- **INFORMATION**  
Select this to read information-level, warning-level, and error-level logs.
- **TRACE1,2,3**  
Select this to read logs of internal trace, and those from the information, warning and error levels. The greater the number is, more detailed the trace is.

### Output on JAVA Console

Click this to configure whether or not to output on JAVA console.

## Collecting Builder log

Select **Save Log Files** to collect the Builder logs.

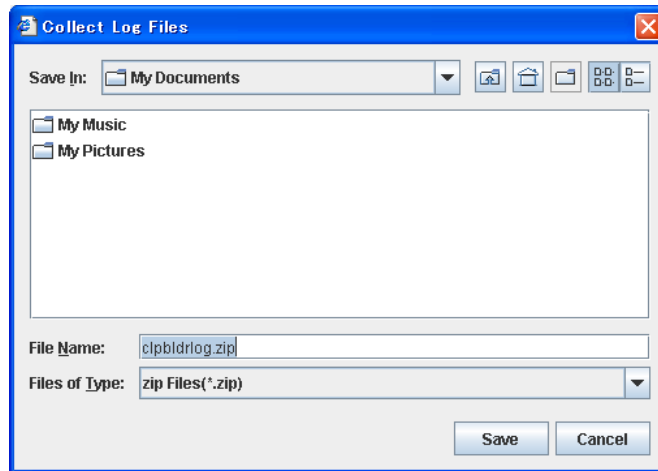

Specify the destination where logs are to be stored and then click **Save**.

## Exiting from the Builder

Exit from the Builder by selecting **Exit**. Do not exit from your Web browser.

If any change was made in the cluster configuration data, a dialog box asks if you want to save the changes.

Click **Yes** to save the changes. You see a dialog box where you can specify a folder to save the file. For how to save the file, see "Saving the configuration file" on page 156.

Click **No** if you do not need to save the changes. Exit from the Builder discarding the changes you made in the cluster configuration data.

Click **Cancel** to cancel exit.

## View menu

Select **View** menu and the following pull down menu is displayed.

**View** menu is not displayed on offline version.

Menu	Function description
Operation Mode	Switch to the Operation Mode
Config Mode	Switch to the Config Mode
Reference Mode	Switch to the Reference Mode
Verification Mode	Switch to the Verification Mode.

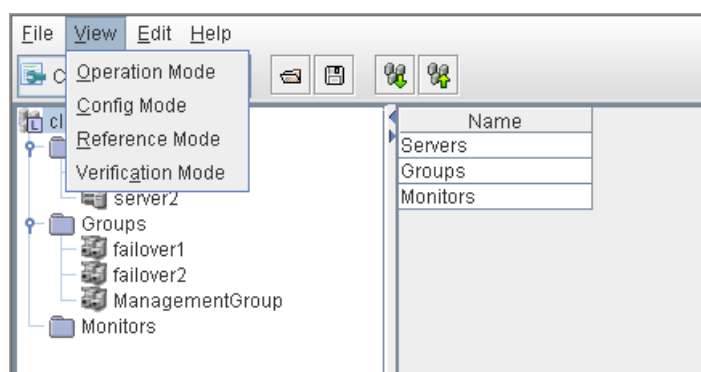

## Operation Mode

Switches from the currently displayed mode to the WebManager operation mode.

This is the same as selecting the  icon from the drop-down menu on the toolbar.

This icon is grayed out if the password for the reference mode is used to log in to the WebManager.

## Config Mode

Switches from the currently displayed mode to the Builder config mode.

This is the same as selecting the  icon from the drop-down menu on the toolbar.

## Reference Mode

Switches from the currently displayed mode to the WebManager reference mode.

This is the same as selecting the  icon from the drop-down menu on the toolbar.

## Verification Mode

Switches from the currently displayed mode to the WebManager verification mode.

This is the same as clicking the  icon from the drop-down menu on the toolbar.



## Edit menu

To open the **Edit** menu, click Edit on the following menu bar.

Menu	Functional overview
Add	Adds an object.
Remove	Deletes the selected object.
Rename	Renames the selected object.
Properties	Displays the properties of the selected object.
Add Management Group	Adds a management group.

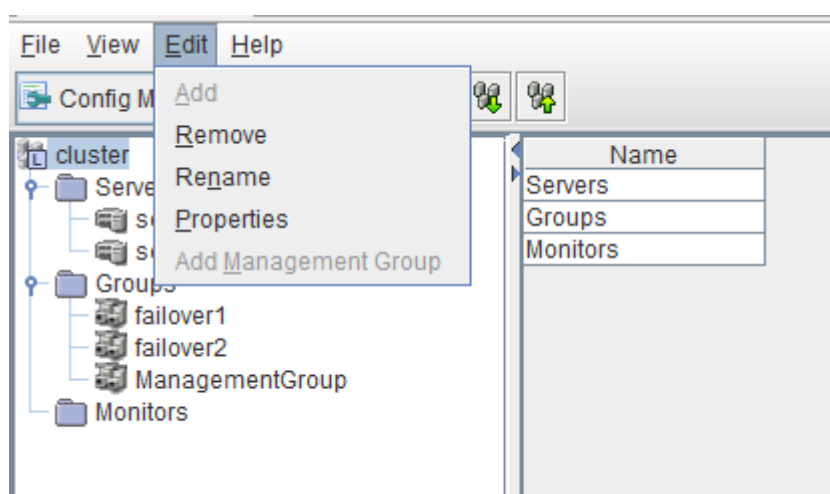

## Adding an object

Displays the wizard for adding a cluster, server, group, group resource, or monitor resource. For details, see Chapter 5, “Creating the cluster configuration data” in the *Installation and Configuration Guide*.

What you can add varies depending on what you select as shown below.

If select	Object to be added
Groups	Group Management group
<i>group_name</i>	Group resource
Monitor Resources	Monitor resource
Servers	Server

### Note:

If Auto Failback is set to **Failback Attribute** in **Group Properties**, a mirror disk resource/hybrid disk resource cannot be added. Set **Failback Attribute** to **Manual Failback** and add a mirror disk resource/hybrid disk resource.

## Removing an object

Displays a dialog box that asks if you want to remove the selected cluster, server, group, group resource, or monitor resource. Click **Yes** to remove it or **No** to not remove it.

To remove a cluster, follow the same procedures described in “Creating a new cluster.”

You cannot remove an object if any of the following conditions is met:

If select	Conditions	How to change
Cluster Name	None	
Server Name	<ul style="list-style-type: none"> <li>- There is no other server.</li> <li>- The server is the only server where the group can start up.</li> <li>- The server is registered with a server group.</li> </ul>	Cluster stop, start
Group Name	<ul style="list-style-type: none"> <li>- A recovery target of monitor resource<sup>1</sup>.</li> <li>- Has group resources.</li> </ul>	Cluster stop, start
Group Resource Name	<ul style="list-style-type: none"> <li>- A recovery target of monitor resource<sup>1</sup>.</li> <li>- A target object of monitor resource monitoring timing<sup>1</sup>.</li> <li>- Other group resources in the same group depend on it.</li> </ul>	For other than mirror disk resources/hybrid disk resource: Cluster stop, start For mirror disk resources/hybrid disk resources:  Cluster stop Mirror agent stop Mirror agent start Cluster start
Monitor Resource Name	<ul style="list-style-type: none"> <li>- <b>Auto Mirror Recovery</b> is selected on the <b>Mirror Agent</b> tab of <b>Cluster Properties</b> for mirror disk monitor resource.</li> <li>- A virtual IP monitor resource</li> </ul>	Cluster suspend, resume

<sup>1</sup> A message asks if you want to delete the specified object’s monitor resources. If you select **Yes** (delete), the specified object’s monitor resources will be deleted, and the object will be deleted.

## Renaming an object

Displays a dialog box for renaming the selected cluster, server, group, group resource, or monitor resource.

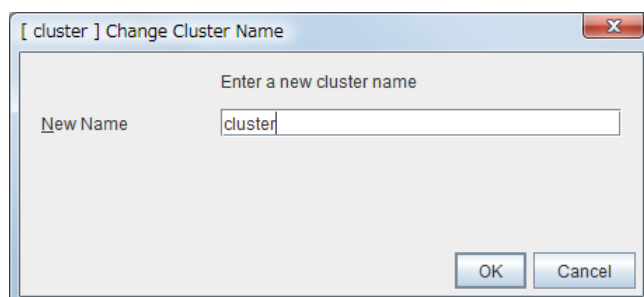

The following are restrictions for each of the objects.

If select	Naming rules	How to change
Group Name	<ul style="list-style-type: none"> <li>-Only alphanumeric characters, hyphen (-), underscore (_) and space are allowed for names.</li> <li>-Up to 31 characters (31 bytes)</li> <li>-Names cannot start or end with a hyphen (-) or space.</li> </ul>	Cluster stop, start
Group Resource Name		For other than mirror disk resource/hybrid disk resource. Cluster stop, start For mirror disk resource/hybrid disk resource Cluster stop Mirror agent stop Mirror agent start Cluster start
Cluster Name Monitor Resource Name		Cluster suspend, resume
Server Name	<ul style="list-style-type: none"> <li>- There are naming rules that are the same as the host name of TCP/IP that can be set by the OS. It should be completely the same as the name set to the server.</li> <li>- Up to 255 characters (255 bytes)</li> <li>- Neither hyphen (-) nor space can be the first or last letter in names.</li> <li>- Underscores (_) cannot be used.</li> <li>- A name consisting of only numbers is not allowed.</li> <li>- "localhost" cannot be used as a server name.</li> </ul>	When changing a server name, you have to be careful. For the procedure for changing the server name, see "Changing the host name" in Chapter 10, "The system maintenance information" in the <i>Reference Guide</i> .

Names should be unique (case-insensitive) by categories such as cluster, server, server group, group, group resource and monitor resource.

## Properties

Displays properties of a selected cluster, server, group, group resource, monitor resource, Servers.

For details, see "Parameter details" on page 169.

## Help Menu

### Checking the version information of the Builder

To check the version information of the Builder, click the Help icon on the toolbar, or click Help in the menu bar and select **Version Information**.

## Parameter details

### Cluster properties

In **Cluster Properties**, you can view and change the cluster's settings.

#### Info tab

You can view the cluster name, and enter or change a comment for this cluster.

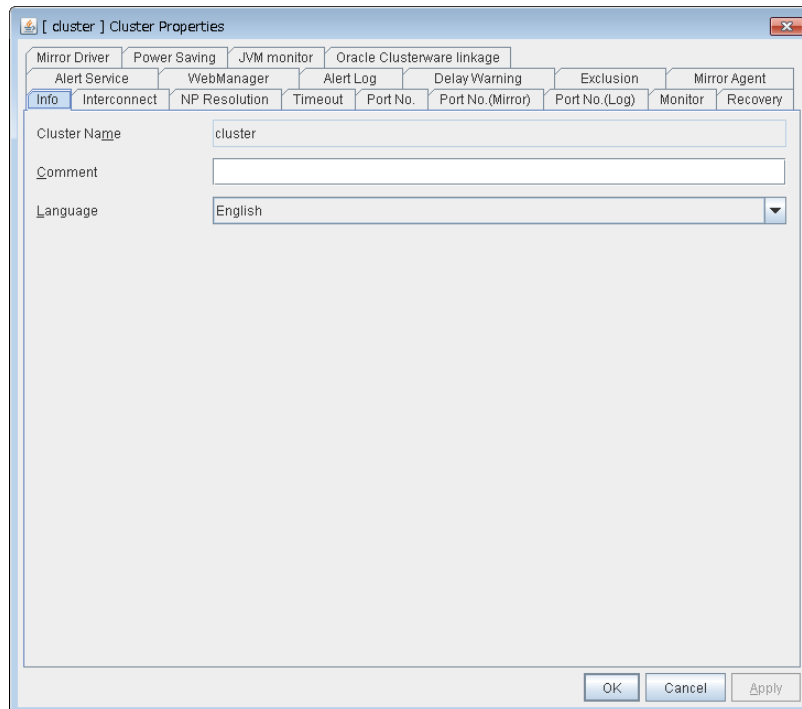

#### Cluster name

The cluster name is displayed. You cannot change the name here.

#### Comment (Within 127 bytes)

You can enter a comment for the cluster. Only alphanumeric characters are allowed.

#### Language

Select a language for cluster from the following. Set the language (locale) of OS on which the WebManager runs.

- ◆ English
- ◆ Japanese
- ◆ Chinese

WebManager and the results of `clpstat` command are displayed in the language set in the **Language** settings on the cluster properties.

---

**Notes:** Run the `clpstat` command in the environment where the font of the specified language can be displayed.

On the console which is connected to a server directly, setting a frame buffer is required. When logging on to the server remotely using `ssh`, a terminal emulator which can display the specified language may be needed.

---

## Interconnect tab

This tab allows you to set up network communication paths between cluster servers.

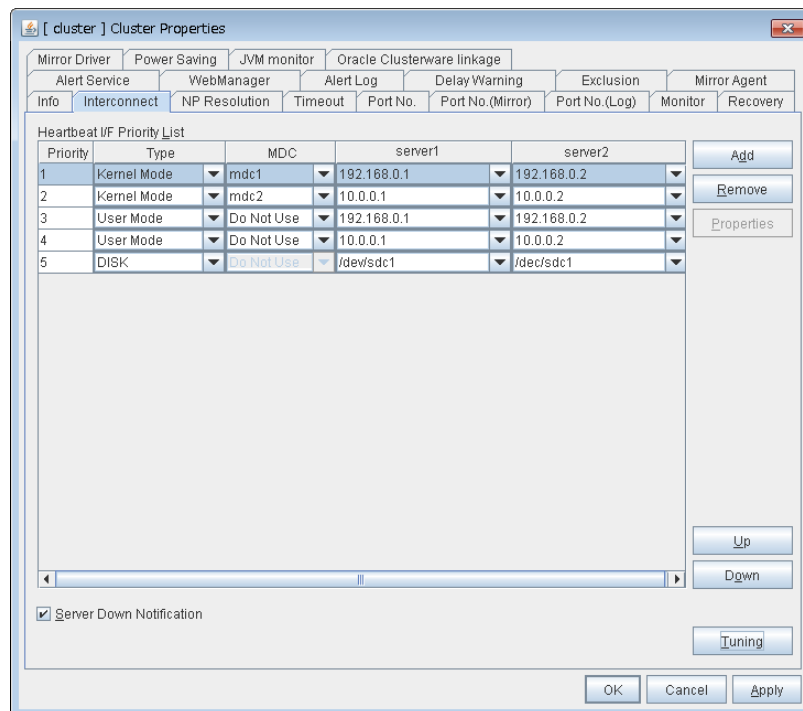

The **Communication paths between servers list** displays network communication paths between servers in the cluster.

### Add

Adds a communication path. To specify the IP address of the communication path for each server, click a cell in each server's column, and then select or enter the address. If some servers are not connected on the communication path, leave the cells for all the unconnected servers empty.

### Remove

Removes a communication path. Select the column of the communication path to remove, and then click **Remove** to remove the selected path.

### Properties

Displays DISK heartbeat properties window. This is only available only when the type is DISK.

### Up, Down

When multiple interconnects are configured, the communication path with the smallest number in the **Priority** column is used preferentially for the internal communication among cluster servers. To change the priority, change the order of selected rows with **Up** or **Down**.

It is recommended to specify a higher priority for the interconnect communication path than any other paths.

**Note:**

**Priority** is used to decide on the priority of communication routes used for internal communication between the servers in the cluster. Heartbeat between the servers in the cluster is implemented on all communication routes that are set up for heartbeat, regardless of **Priority**.

---

**Tuning**

Displays heartbeat I/F tuning property window.

**Priority**

Displays the priority order of the interconnect.

**Type**

Select the path to be used for heartbeat from **Kernel Mode**, **User Mode**, **DISK**, **COM**, **BMC**, or **Mirror Communication Only**

- ◆ **Kernel mode** performs alive monitoring by using kernel mode LAN heartbeat resources.
- ◆ **User Mode** performs alive monitoring by using LAN heartbeat resources.
- ◆ **DISK** performs alive monitoring by using disk heartbeat resources.
- ◆ **COM** performs alive monitoring by using COM heartbeat resources.
- ◆ **BMC** performs alive monitoring by using BMC heartbeat resources.

For details about the heartbeat resources, see “Heartbeat resources details” of Chapter 6, in this guide.

**MDC**

To use a communication path as the mirror disk connect, click **MDC** and then select **Mirror Connect Disk**.

The contents to be entered differ by type.

◆ **Kernel Mode, User Mode, Mirror Communication Only**

Select **Mirror Disk Connect** from the combo box.

When the mirror disk connect is not used, select **Do Not Use**.

---

**Note:**

A combination of IPv4 and IPv6 is not allowed for the IP addresses that are used for mirror disk connects. Specify IP addresses in either IPv4 only or IPv6 only for all mirror disk connects.

---

◆ **DISK, COM, BMC**

The mirror disk connect cannot be used.

**MDC** automatically changes to **Do Not Use** and can no longer be edited.



**Server column**

Entry differs depending on the type.

**◆ Kernel Mode, User Mode, Mirror Communication Only**

Enter IP address. Set blank to the not used communication path.

**◆ DISK**

Enter disk device. Set blank when not using DISK device.

**◆ COM**

Enter COM device. Set blank when not using COM device.

**◆ BMC**

Enter the IP address of the BMC. Set blank when not using the BMC.

---

**Notes:** More than one IP addresses which belong to the same network address cannot exist in a single server. And also, inclusive relation cannot exist like the following relation.

IP address:10.1.1.10, subnet mask:255.255.0.0

IP address:10.1.2.10, subnet mask:255.255.255.0

---

**Server down notification**

When a server stops successfully (including a shutdown or reboot), the server is reported to be down to other servers in the cluster. You can perform failovers faster by reporting this in advance.

When there is a failure to deactivate groups when a server stops (including a shutdown or reboot), or when other abnormalities occur, other servers are not notified of the server that went down regardless of the server down notification settings.

**◆ When Follow the default dependence is selected:**

A server going down is reported.

**◆ When Follow the default dependence is not selected:**

A server going down is not reported.

---

**Note:**

Do not use server down notification when using a hybrid disk resource.

---

### DISK HeartBeat Properties

Displays DISK heartbeat properties.

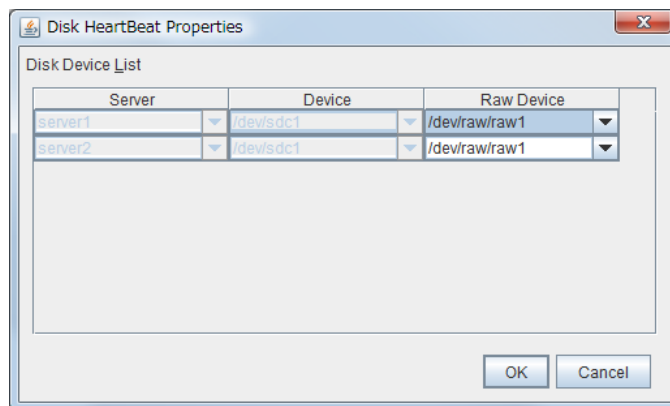

#### Server

Displays server list.

#### Device

Displays the device configured in the previous window.

#### Raw Device

When using RAW device, set RAW device by selecting or entering directly.

When not using RAW device, set blank.

### Heartbeat I/F Tuning Properties

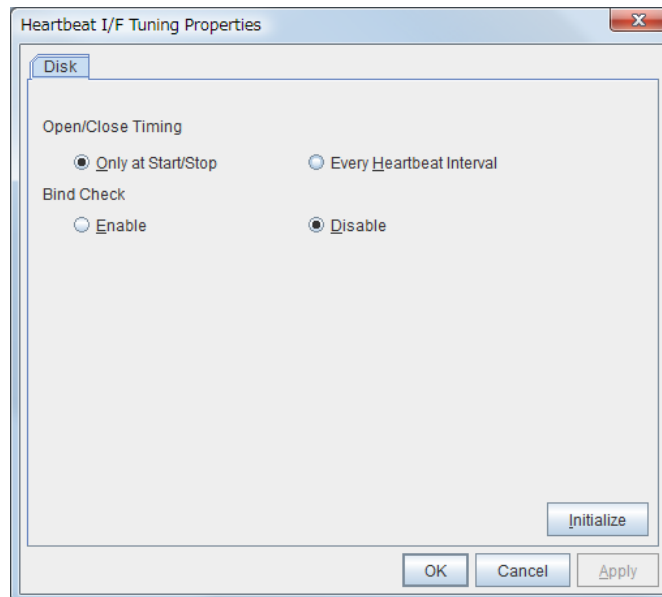

#### ◆ Open/Close Timing

- Only at Start/Stop  
Opens raw device when a cluster starts and close it when a cluster stops. Performs only reads and writes of raw device at each heartbeat interval.
- Every Heartbeat Interval  
Opens raw device when a cluster starts, and closes it when a cluster stops. Performs open, reads, writes and close of raw device at each heartbeat interval.

#### ◆ Bind Check

- Enable  
Checks if raw device for disk heartbeat is not bound to the actual device other than for disk heartbeat. Binding raw device is not performed if it is bound to the actual device other than for disk heartbeat. When binding a disk is not performed, the status of disk heartbeat resource becomes offline.
- Disable  
Does not check if raw device for disk heartbeat is not bound to the actual device other than for disk heartbeat. If raw device is bound to the actual device other than for disk heartbeat, the bind is canceled and raw device is bound to the actual device for disk heartbeat.

#### ◆ Check File System

This cannot be used with this version

## NP Resolution tab

Change the setting of the network partition interface. The network partition resolution interface used for EXPRESSCLUSTER is displayed on the **NP**.

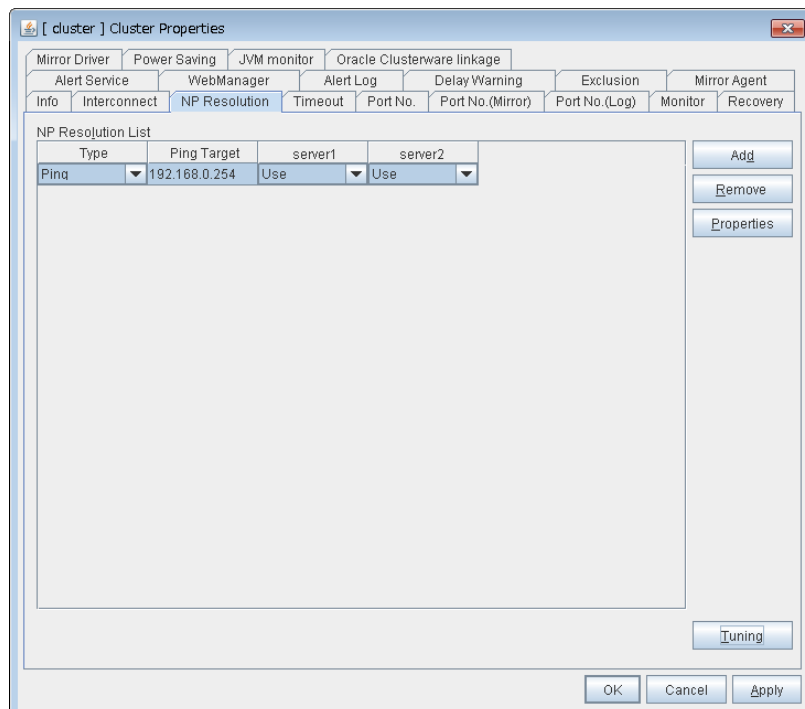

### Add

Add network partition resolution I/F. Click the Ping target column cell and set the IP address. Click the cell of each server and set **Use** or **Do Not Use**.

### Remove

Remove network partition resolution I/F. Select network partition resolution I/F to be removed and click **Remove**, then the selected network partition resolution I/F is removed.

### Properties

Display the Ping NP property window.

### Tuning

Display network partition resolution tuning property window.

### Type

Set the type of network partition resolution I/F. Ping is selectable.

### Ping Target

Set Ping target.

### Server name

Select either **Use** or **Do Not Use**.

### Ping NP Properties

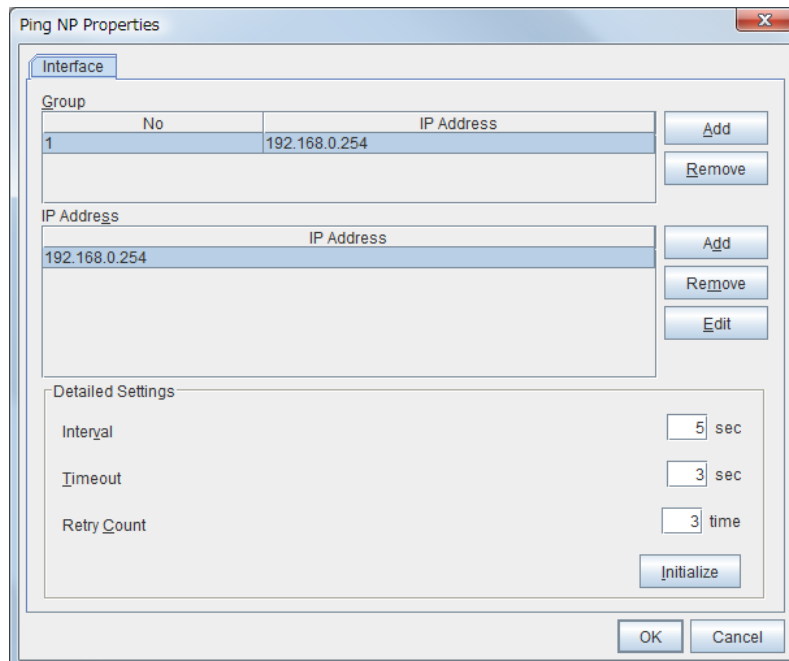

- ◆ Add Group List
  - Add group.
  - The maximum number of registered group is 16.
  - If multiple IP addresses are registered in one group, and if the state in which no response to the Ping command is returned from all the IP addresses is maintained, NP resolution processing cannot be performed (if there is even one IP address responding to the Ping command, NP resolution processing can be performed). Also, if multiple groups are registered, and if the state in which no response to the Ping command is returned from any one group is maintained, NP resolution processing cannot be performed (if all groups respond to the Ping command, NP resolution processing can be done).
- ◆ Remove Group List
  - Remove the selected group.
- ◆ Add IP Address List
  - Add IP address to the selected group.
  - The maximum number of registered IP address is 16.
  - Maximum 256 IP addresses are able to be registered to a single Ping NP, and 16 kinds of IP addresses can be registered. (The same IP addresses can be used.)
- ◆ Remove IP Address List
  - Remove the selected IP address from the list.
- ◆ Edit
  - Edit the selected IP address.
- ◆ Interval
  - Set the Ping interval.

- ◆ Timeout
  - Set the Ping timeout.
- ◆ Retry Count
  - Set the retry count.
- ◆ Initialize
  - Set the interval, timeout and retry count to the default values. Note that, when an interval and retry count are specified, the following conditional expression must be satisfied. If not satisfied, NP resolution processing cannot be performed normally.  
**Conditional expression) Heartbeat timeout > (Ping NP Interval × Ping NP Retry Count) + Ping NP Timeout**

### Network Partition Resolution Tuning Properties

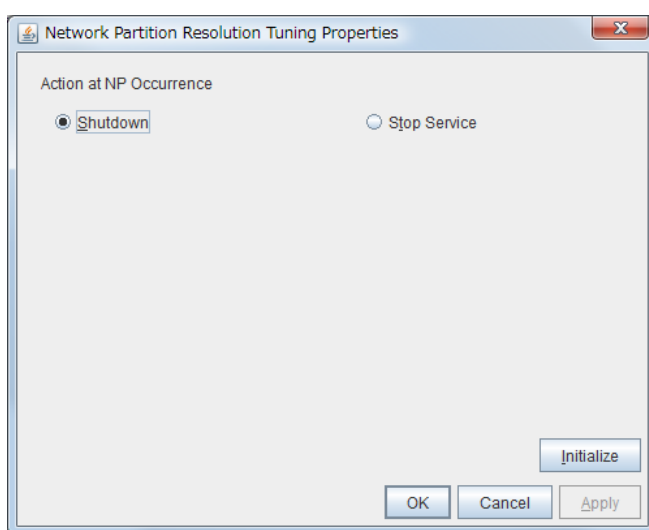

- ◆ Action at NP Occurrence
  - Stop Cluster Service  
Stop the cluster service of the server in network partition.
  - Stop cluster service and shutdown OS  
Stops the cluster service of the server in network partition, and then shuts down the OS.
  - Stop cluster service and reboot OS  
Stops the cluster service of the server in network partition, and then reboots the OS.
  - sysrq Panic  
Performs a sysrq panic on the server in network partition.
  - keepalive Reset  
Use this on the server in network partition to perform an OS reset by using the clpkhb and clpka drivers.
  - keepalive Panic  
Use this on the server in network partition to perform an OS panic by using the clpkhb and clpka drivers.
  - BMC Reset  
Use this on the server in network partition to perform a hardware reset of the server by using the ipmi command.

- **BMC Power-Off**  
Use this on the server in network partition to power off the server by using the `ipmi` command. The OS may be shut down depending on how the ACPI of OS is configured.
  - **BMC Power Cycle**  
Use this on the server in network partition to perform the Power Cycle (powering on/off) by using the `ipmi` command. The OS may be shut down depending on how the ACPI of OS is configured.
  - **BMC NMI**  
Use this on the server in network partition to generate NMI in the server by using the `ipmi` command. The behavior after the generation of NMI depends on the OS setting.
  - **I/O Fencing(High-End Server Option)**  
Use this on the server in network partition to generate I/O Fencing and NMI.
- ◆ **Initialize**
- Set the actions at NP occurrence to the default settings.

## Timeout tab

Specify values such as time-out on this tab.

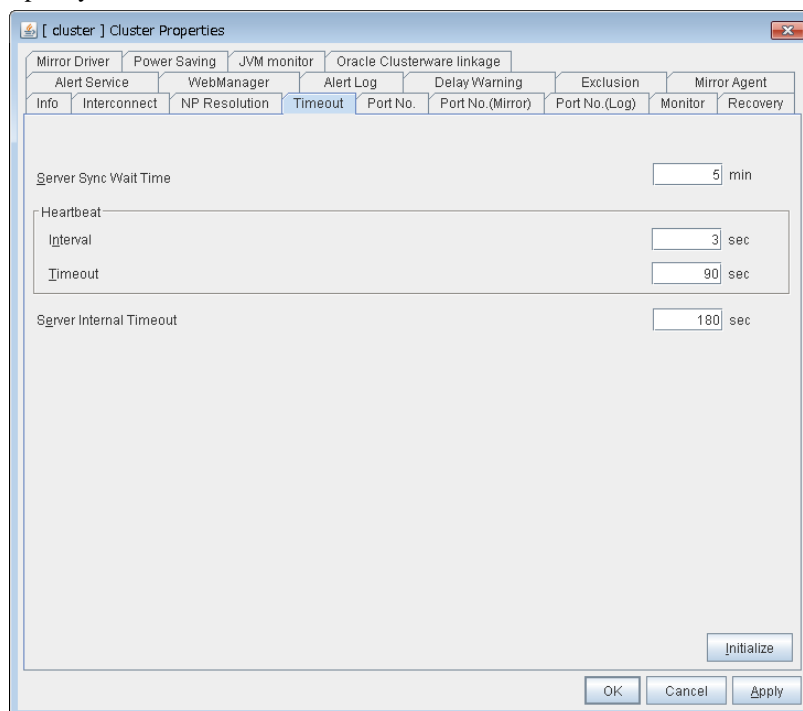

### Server Sync Wait Time (0 to 99)

For the time specified here, the server will wait at startup until other servers are started.

### Heartbeat

Heartbeat interval and heartbeat time-out.

#### ◆ Interval (1 to 99)

Interval of heartbeats

#### ◆ Timeout (2 to 9999)

A failed server is determined if there is no response for the time specified here.

- This time-out should be longer than the interval.
- To perform the shutdown monitoring (see Monitor tab on page 185), this time-out should be longer than the time it takes to shut down applications and the operating system.
- When a hybrid disk resource is used, the time-out value must be longer than the value specified at the cluster partition I/O time-out in the **mirror agent** tab.

### Server Internal Timeout (1 to 9999)

The timeout to be used in the EXPRESSCLUSTER Server internal communications that are performed while an EXPRESSCLUSTER command is executed, or an operation is performed or a screen is displayed by WebManager.

### Initialize

Used for initializing the value to the default value. Click **Initialize** to initialize all the items to their default values.



## Port No. tab

Specify TCP port numbers and UDP port numbers.

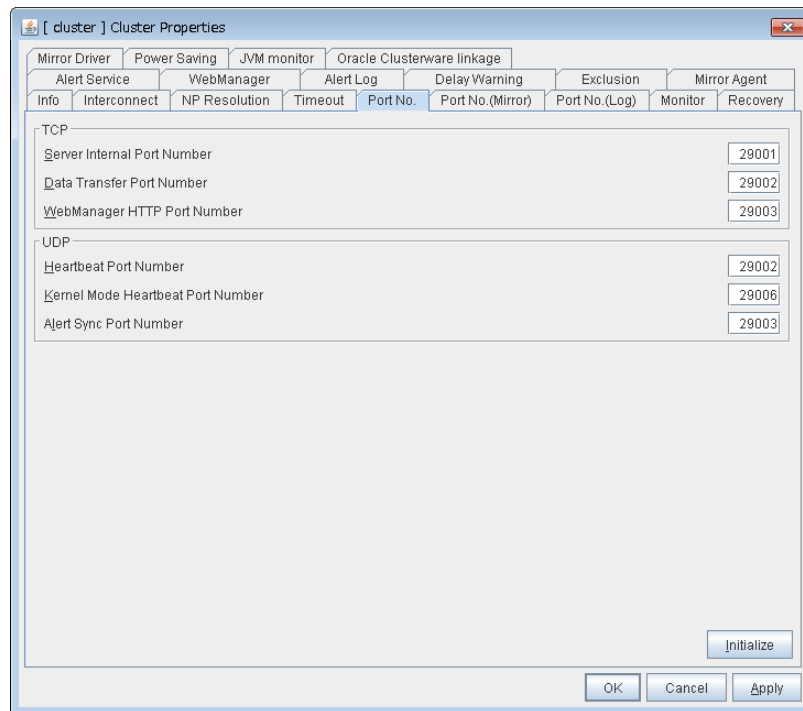

### TCP

No TCP port numbers can be overlapped. When the Replicator is used, TCP port numbers on the **Port No.(Mirror)** tab and any mirror data port number of any mirror disk resources/hybrid disk resources cannot be overlapped.

- ◆ **Server Internal Port Number** (1 to 65535<sup>2</sup>)  
This port number is used for internal communication.
- ◆ **Data Transfer Port Number** (1 to 65535<sup>2</sup>)  
This port number is used for transactions such as applying and backing up the cluster configuration data, sending and receiving the license data and running commands.
- ◆ **WebManager HTTP Port Number** (1 to 65535<sup>2</sup>)  
This port number is used for a browser to communicate with the EXPRESSCLUSTER Server.

### UDP

No UDP port numbers can be overlapped. When the communication method for internal logs is UDP on the **Port No.(Log)** tab, UDP port numbers cannot be overlapped with the port numbers.

- ◆ **Heartbeat Port Number** (1 to 65535<sup>2</sup>)  
This port number is used for heartbeat.
- ◆ **Kernel Mode Heartbeat Port Number** (1 to 65535<sup>2</sup>)  
This port number is used for kernel mode heartbeat.

<sup>2</sup> It is strongly recommended not to use well-known ports, especially reserved ports from 1 to 1023. Section I Detailed reference of EXPRESSCLUSTER functions

◆ **Alert Sync Port Number** (1 to 65535<sup>2</sup>)

This port number is used for synchronizing alert messages among servers.

**Initialize**

This is used for initializing the value to the default value. Click **Initialize** to initialize all items to their default values.

## Port No. (Mirror) tab ~ For the Replicator/Replicator DR ~

Specify TCP port numbers.

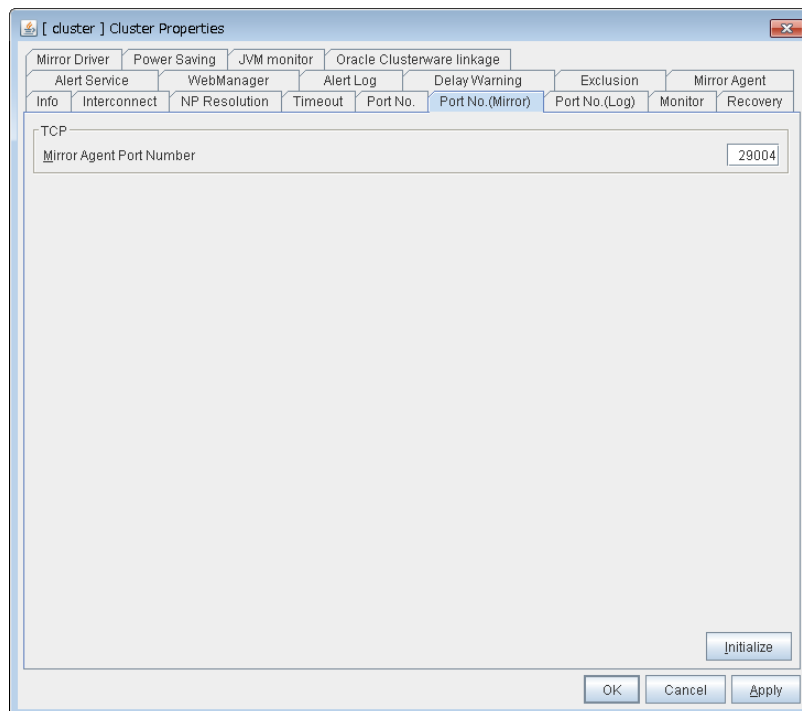

### TCP

No TCP port numbers can be overlapped. TCP port numbers on the **Port No.** tab and any mirror data port number of any mirror disk resources/hybrid disk resources cannot be overlapped.

---

**Note:** Port numbers are not used when mirror disk resource/hybrid disk resource is not used.

---

- ◆ Mirror Agent Port Number (1 to 65535<sup>2</sup>)

Mirror agent is a user mode module for controlling mirror disk resource/hybrid disk resource. The Mirror Agent uses this port number to communicate with servers.

### Initialize

Used for initializing the value to the default value. Click **Initialize** to initialize all the items to their default values.

## Port No. (Log) tab

Specify the communication method for internal logs.

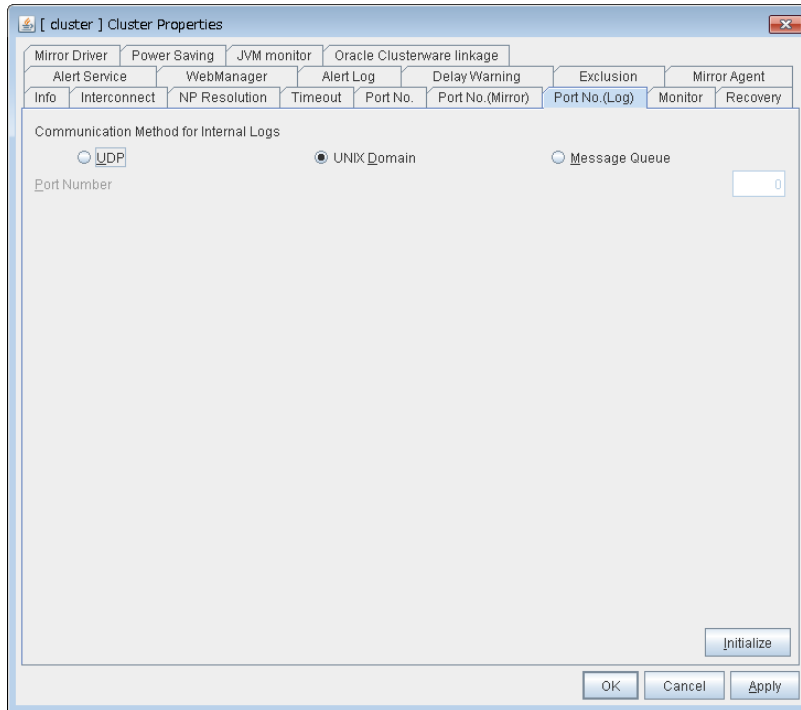

### Communication Method for Internal Logs

- ◆ UDP  
Use UDP for the communication method for internal logs.
- ◆ UNIX Domain  
Use UNIX Domain for the communication method for internal logs.
- ◆ Message Queue  
Use Message Queue for the communication method for internal logs.

---

### Note:

UDP cannot be used with SuSE Linux Enterprise Server 11.

---

### Port No.(1 to 65535)

This is the port number used when UDP is selected for the communication method for internal logs.

### Initialize

Used for initializing the value to the default value. Click **Initialize** to initialize all the items to their default values.

## Monitor tab

Configure the settings for monitoring. For details about the shutdown monitor and reboot limit, see Chapter 5, “Monitor resource details” in this guide.

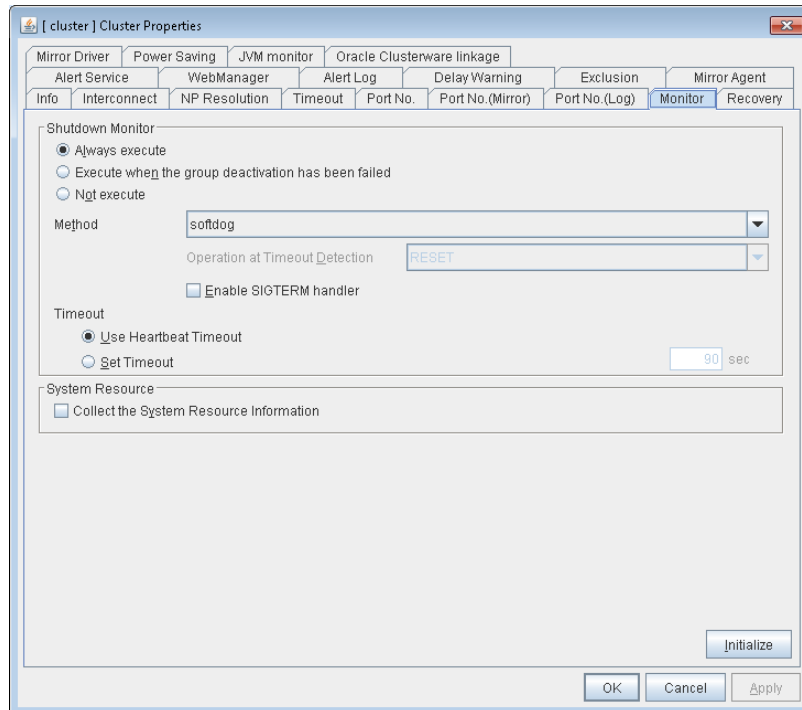

### Shutdown Monitor

Monitors whether or not the operating system is stalling when an EXPRESSCLUSTER command to shut down the cluster or servers is run. The cluster service forcibly resets the operating system or performs a panic of the operating system if it determines the OS stall. Server panic can be set when the monitoring method is keepalive.

#### ◆ Always execute:

If selected, the shutdown monitor is performed. For the heartbeat time-out, specify a longer time than the time required to shut down every application and the operating system (see “Timeout tab” on page 180). If you use shared disks or mirror disks, it is recommended to select **Always execute**.

#### ◆ Execute when the group deactivation has been failed:

The shutdown monitor is applied only when a group cannot be deactivated. For the heartbeat time-out, specify a longer time than the time required to shut down every application and the operating system (see “Timeout tab” on page 180).

#### ◆ Not execute:

If selected, the shutdown monitor is not performed.

##### • Method

Select the shutdown monitor method from:

softdog

ipmi

ipmi (High-End Server Option)

keepalive

For details about the shutdown monitoring method, see “Shutdown monitoring Shutdown monitoring method” in Chapter 8, “Information on other settings” in this guide.

- **Operation at Timeout Detection**

Selects the operation performed when the operating system is determined to be stalled. This can be set only when the monitoring method is keepalive.

RESET

Resets the server.

PANIC

Performs a panic of the server.

- **Enable SIGTERM handler**

Select this to enable SIGTERM handler when performing the shutdown monitor.

For details about the SIGTERM settings, see “Shutdown monitoring Setting of SIGTERM” in Chapter 8, “Information on other settings” in this guide.

---

**Note:**

If you select ipmi in **Method** and set **Enable SIGTERM handler** to **Off**, this may be reset even if the operating system is successfully shut down.

---

- **Use Heartbeat Timeout**

Select this for heartbeat time-out to work in conjunction with shutdown monitoring time-out.

- **Timeout (2 to 9999)**

Specify a time-out when the heartbeat time-out value is not used as shutdown monitoring time-out.

A value smaller than the heartbeat timeout value must be specified to prevent both systems from activating when a failover occurs upon detection of a server down.

### System Resource

Select whether to collect system resource information.

System resource information is collected regularly so as to improve system operability. System resource information is useful for investigating the operation status of EXPRESSCLUSTER, and makes it easy to determine the cause of a failure attributable to a shortage of system resources.

- When the check box is selected

System resource information related to the CPU, memory, processes, and others is collected regularly while the cluster is running.

The collected system resource information are collected as a log by the `clplogcc` command or WebManager.

Specify type 1 to collect the log by the `clplogcc` command; specify Pattern 1 to collect the log by the WebManager. For details about log collection, see “Collecting logs (`clplogcc` command)” in Chapter 3, “EXPRESSCLUSTER command reference,” as well as “Collecting logs by using the WebManager” in Chapter 1, “Functions of the WebManager” in this guide.

A disk area of 450 MB or more is required to store the resource information, depending on the system operating conditions such as the number of processes that are running.

- When the check box is cleared

No system resource information is collected.

## Recovery tab

Configure the settings for cluster recovery.

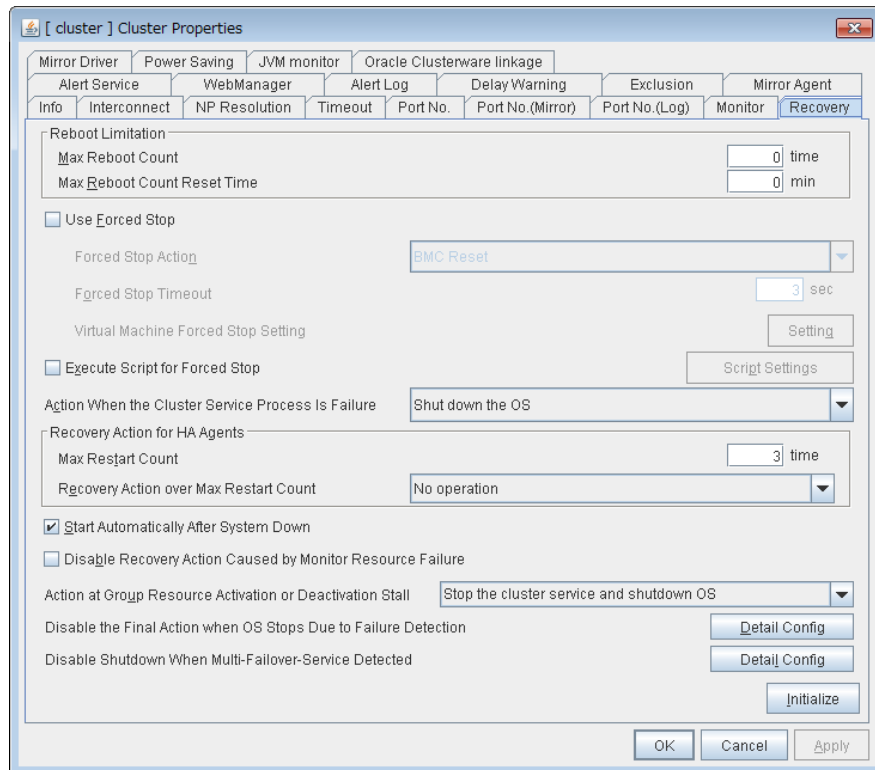

### Reboot Limitation

If the final action at abnormality detection for group resources and monitor resources is specified with the setting accompanied by OS reboot, reboot may be repeated infinitely. By setting the reboot limit, you can prevent repeated reboots.

- ◆ **Max Reboot Count** (0 to 99)

Specify how many times the operating system can reboot. The number specified here is separately counted for group resource and monitor resource.

- ◆ **Max Reboot Count Reset Time** (0 to 999)

When the max reboot count is specified, if the operation from the cluster startup keeps running normally for the time specified here, the reboot count is reset. The time specified here is separately counted for group resource and monitor resource.

---

**Note:**

If **Max Reboot Count Reset Time** is set to 0, the reboot count is not reset. If you want to reset the reboot count, use `clpregctrl` command.

---

### Use Forced Stop

Use this to select whether or not to enable the forced stop.

- On

If selected, the forced stop function is enabled.

For a physical machine, configure the settings on the **BMC** tab of the server properties. For a virtual machine (guest OS), configure the **Virtual Machine** setting on the **Info** tab of the server properties.



- Off  
If selected, the forced stop function is disabled.

### Forced Stop Action

Specify an action of the forced stop.

- **BMC Reset**  
Use this to perform a hardware reset of the server by using the `hwreset` command , the `ireset` command or the `ipmitool` command.
- **BMC Power off**  
Use this to power off the server by using the `hwreset` command, the `ireset` command or the `ipmitool` command. The OS may be shut down depending on how the ACPI of OS is configured.
- **BMC Power Cycle**  
Use this to perform the Power Cycle (powering on/off) by using the `hwreset` command, the `ireset` command or the `ipmitool` command. The OS may be shut down depending on how the ACPI of OS is configured.
- **BMC NMI**  
Use this to generate NMI by using the `hwreset` command , the `ireset` command or the `ipmitool` command. The performance after the generation of NMI depends on the OS setting.

### Forced Stop Timeout (0 to 99)

Configure the timeout value when performing Forced Stop. After the above commands are executed, activating failover groups starts when the time specified elapses

### Virtual Machine Forced Stop Setting

Configure forced stop for the virtual machine (guest OS). Click **Setting** to display the **Virtual Machine Forced Stop Setting** dialog box.

The screenshot shows a dialog box titled "Virtual Machine Forced Stop Setting". It has a "Parameter" tab selected. Under "Virtual Machine Management Tool", a dropdown menu shows "vCenter". The "Forced Stop" section includes:
 

- "Action": dropdown menu showing "poweroff"
- "Timeout": text input field with "30" and "Sec" label
- "Command": dropdown menu showing "/usr/lib/vmware-vccli/apps/vm/vmcontrol.pl"

 Below this is a "vCenter" section with:
 

- "Host Name": empty text input field
- "User Name": empty text input field
- "Password": empty text input field with a "Change" button to its right

 At the bottom of the dialog are three buttons: "OK", "Cancel", and "Apply".

### Virtual Machine Management Tool

◆ vCenter

Select this when you want to use vCenter to control the virtual machine.

### Forced Stop

◆ Action

Specify the action performed upon a forced stop.

- Power Off

Use this to power off the server by using the command specified in **Command**.

◆ Timeout (**0 to 99**)

Set the timeout value to be used when performing a forced stop. After the above command is executed, the activation of failover groups starts when the time specified here elapses.

◆ Command (**Within 1023 bytes**)

Specify the command for forced stop.

### vCenter

◆ Host Name (**Within 45 bytes**)

Specify the host name of the virtual machine management tool.

◆ User Name (**Within 255 bytes**)

Specify the user name of the virtual machine management tool.

◆ Password

Specify the password for the virtual machine management tool.

---

**Note:** Do not use a double quotation mark (") in the password.

---

### Execute Script for Forced Stop

Use this to select whether or not to execute a script for the forced stop.

- On

If selected, the script is executed for the forced stop.

- Off

If selected, the script is not executed.

### Script Setting

Make settings on the script for the forced stop. Click **Script Setting** play the **Edit Script** dialog box.

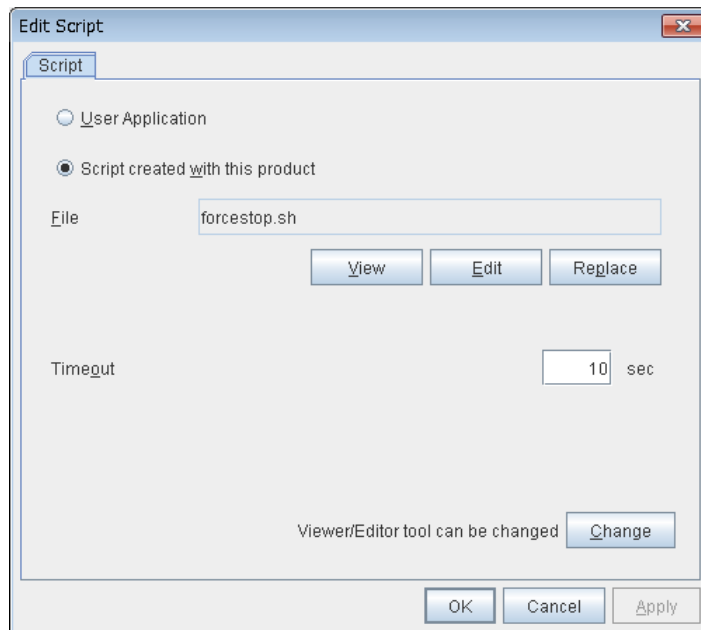

### User Application

Use an executable file (executable shell script file or execution file) on the server as a script. For the file name, specify an absolute path or name of the executable file of the local disk on the server. If there is any blank in the absolute path or the file name, put them in double quotation marks (“”) as follows.

Example:

”/tmp/user application/script.sh”

Each executable file is not included in the cluster configuration information of the Builder. They must be prepared on each server because they cannot be edited or uploaded by the Builder.

### Script created with this product

Use a script file which is prepared by the Builder as a script. You can edit the script file with the Builder if you need. The script file is included in the cluster configuration information.

### File (Within 1023 bytes)

Specify a script to be executed (executable shell script file or execution file) when you select **User Application**.

### View

Click here to display the script file with the editor when you select **Script created with this product**. The information edited and stored with the editor is not applied. You cannot display the script file if it is currently displayed or edited.

### Edit

Click here to edit the script file with the editor when you select **Script created with this product**. Overwrite the script file to apply the change. You cannot edit the script file if it is currently displayed or edited. You cannot modify the name of the script file.

### Replace

Click here to replace the contents of a script file with the contents of the script file which you selected in the file selection dialog box when you select **Script created with this product**. You cannot replace the script file if it is currently displayed or edited. Select a script file only. Do not select binary files (applications), and so on.

### Timeout (1 to 9999)

Specify the maximum time to wait for completion of script to be executed. The default value is set as 10.

### Change

Click here to display the **Change Script Editor** dialog. You can change editor for displaying or editing a script to an arbitrary editor.

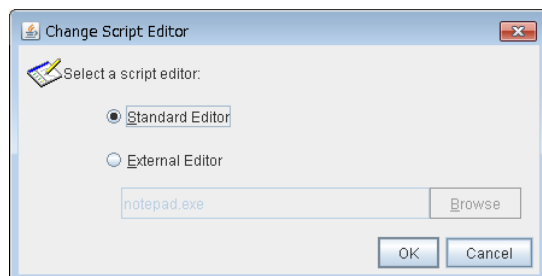

### Standard Editor

Select this option to use the standard editor for editing scripts.

Linux: vi (vi which is detected by the user's search path)

Windows: Notepad (notepad.exe which is detected by the user's search path)

### External Editor

Select this option to specify a script editor. Click **Browse** to select an editor.

To specify a CUI-based external editor on Linux, create a shell script.

The following is a sample shell script to run vi:

```
xterm -name clpedit -title " Cluster Builder " -n " Cluster Builder"  
-e vi "$1"
```

**Action When the Cluster Service Process Is Abnormal**

Specify the action when a cluster service process error occurs.

- OS shutdown  
Shut down the OS.
- OS reboot  
Reboot the OS.
- sysrq Panic  
Performs a sysrq panic on the server in network partition..
- keepalive Reset  
Use this on the server in network partition to perform an OS reset by using the clpkhb and clpka drivers.
- keepalive Panic  
Use this on the server in network partition to perform an OS panic by using the clpkhb and clpka drivers.
- BMC Reset  
Use this on the server in network partition to perform a hardware reset of the server by using the ipmi command.
- BMC Power-Off  
Use this on the server in network partition to power off the server by using the ipmi command. The OS may be shut down depending on how the ACPI of OS is configured.
- BMC Power Cycle  
Use this on the server in network partition to perform the Power Cycle (powering on/off) by using the ipmi command. The OS may be shut down depending on how the ACPI of OS is co
- BMC NMI  
Use this on the server in network partition to generate NMI in the server by using the ipmi command. The behavior after the generation of NMI depends on the OS setting.
- I/O Fencing(High-End Server Option)  
Use this on the server in network partition to generate I/O Fencing and NMI.

**Recovery Action for HA Agents**

- ◆ Max Restart Count (0 to 99)  
Specify the max restart count when an HA Agent error has occurred.
- ◆ Recovery Action over Max Restart Count  
Specify the action when an HA Agent error has occurred.
  - No operation
  - Stop cluster service  
Stops the cluster service of the server that detected an error.
  - Stop cluster service and shutdown OS  
Stops the cluster service of the server that detected an error, and then shuts down the OS.

- Stop cluster service and reboot OS  
Stops the cluster service of the server that detected an error, and then reboots the OS.

---

**Note:**

The HA process is used with the system monitor resources, JVM monitor resources, and the system resource information collection function.

---

**Start Automatically After System Down**

Set whether to prohibit automatic startup of the cluster service at the next OS startup when the server has been stopped by a means other than cluster shutdown or cluster stop, or when cluster shutdown or stop does not terminate normally.

For the conditions to prohibit automatic startup of the cluster service after system down, see “Conditions for automatic startup prohibition” in Chapter 8, “Information on other settings”.

**Disable Recovery Action Caused by Monitor Resource Error**

- When the check box is selected  
The recovery action is disabled when the monitor resource is error.
- When the check box is cleared  
The recovery action is enabled when the monitor resource is error.

---

**Note:** This option is not available for the message receive monitor resource.

---

**Action to apply in the event of an activation/deactivation stall of a group resource**

Specify the action to apply in the event of an activation/deactivation stall of a group resource.

- **Stop cluster service and shutdown OS**  
Stops the cluster service of the server that stalled, and then shuts down the OS.
- **Stop cluster service and reboot OS**  
Stops the cluster service of the server that stalled, and then restarts the OS.
- **sysrq Panic**  
Performs a sysrq panic on the server that stalled.
- **keepalive Reset**  
Use this on the server that stalled to perform an OS reset by using the `clpkhb` and `clpka` drivers.
- **keepalive Panic**  
Use this on the server that stalled to perform an OS panic by using the `clpkhb` and `clpka` drivers.
- **BMC Reset**  
Use this on the server that stalled to perform a hardware reset of the server by using the `ipmi` command.
- **BMC Power-Off**  
Use this on the server that stalled to power off the server by using the `ipmi` command. The OS may be shut down depending on how the ACPI of OS is configured.
- **BMC Power Cycle**  
Use this on the server that stalled to perform the Power Cycle (powering on/off) by using the `ipmi` command. The OS may be shut down depending on how the ACPI of OS is configured.
- **BMC NMI**  
Use this on the server that stalled to generate NMI in the server by using the `ipmi` command. The behavior after the generation of NMI depends on the OS setting.
- **I/O Fencing(High-End Server Option)**  
Use this on the server in network partition to generate I/O Fencing and NMI.
- **Nothing (handle a stall as an activation/deactivation failure)**  
Use this to perform recovery upon the detection of an activation/deactivation failure of a group resource. For details on the recovery operation, see “Displaying and changing the operation settings when a group resource error is detected (Common to group resources)” in “Displaying and changing the settings of group resources” in Chapter 4, “Group resource details” in this guide.

---

**Note:**

If a stall occurs with “Nothing (handle a stall as an activation/deactivation failure)” specified, the effect on the group resources is undefined, so we do not recommend changing the setting to “Nothing (handle a stall as an activation/deactivation failure).”.

If you do specify “Nothing (handle a stall as an activation/deactivation failure)”, set the recovery operation upon the detection of an activation/deactivation failure of a group resource as described below.

---

- Activation/Deactivation Retry Threshold: 0
  - Failover Threshold: 0
  - Final Action: Action that accompanies the OS stop
- 

### Disable the Final Action when OS Stops Due to Failure Detection

Click **Detail Config** to set suppression of the final action which accompanies the OS stop caused by error detection.

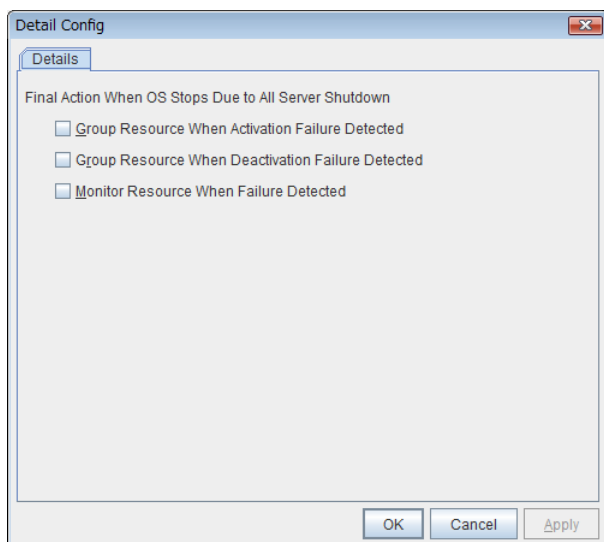

- **Group Resource When Activation Failure Detected**  
If the final action caused by an activation error detection in a group resource accompanies the OS stop, the final action is suppressed if all other servers are stopped.
- **Group Resource When Deactivation Failure Detected**  
If the final action caused by a deactivation error detection in a group resource accompanies the OS stop, the final action is suppressed if all other servers are stopped.
- **Monitor Resource When Failure Detected**  
If the final action caused by an error detection in a monitor resource accompanies the OS stop, the final action is suppressed if all other servers are stopped.

---

#### Note:

- If errors were detected on multiple servers almost at the same time, and the final action was taken for those servers, the final action which accompanies the OS stop may be taken for all the servers even if the final action caused by an error detection in a monitor resource is set to be suppressed.
  - The message receive monitor resource does not become the target for which the final action caused by error detection is suppressed.
-



- 
- The following situations lead to an OS stop during the final action when an activation/deactivation error is detected in a group resource and during the final action when a monitor resource error is detected.
    - Cluster service stop and OS shutdown
    - Cluster service stop and OS restart
    - sysrq panic
    - keepalive reset
    - keepalive panic
    - BMC reset
    - BMC power off
    - BMC power cycle
    - BMC NMI
- 

### Disable Shutdown When Multi-Failover Detected

Click **Detail Config** to suppress the shutdown of all servers upon detection of both-system activation.

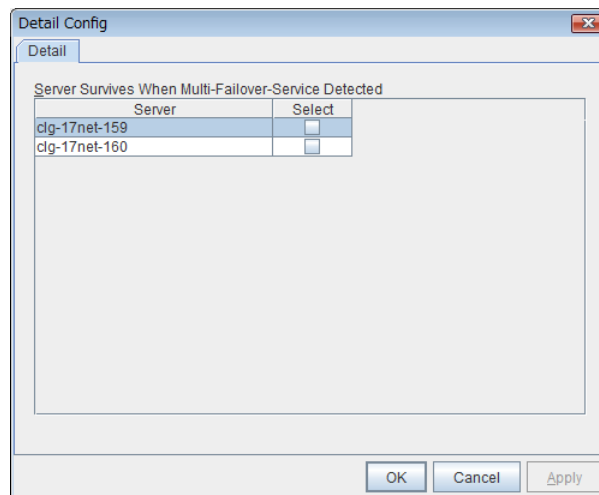

Select one server. The shutdown of the server, selected when the both-system activation of the failover group was detected, is suppressed.

---

#### Note:

When the both-system activation is detected, the group statuses will be inconsistent among the servers, and failover and failback operations will be able to fail.

If a group status mismatch occurs, the following alert log is output. Restart or execute cluster reboot to fix this problem.

Type: Warning

Module name: rc

Event ID: 503

Message: A mismatch in the group %1 status occurs between the servers.

---

## Alert Service tab

Configure the settings for the mail report function, the network warning light, alert report destination, and SNMP trap transmission.

To use the mail report function, register the Alert Service license.

To use the network warning light, register the Alert Service license.

---

### Note:

To use the mail report function and the network warning light, purchase the EXPRESSCLUSTER X Alert Service 3.3 for Linux.

---

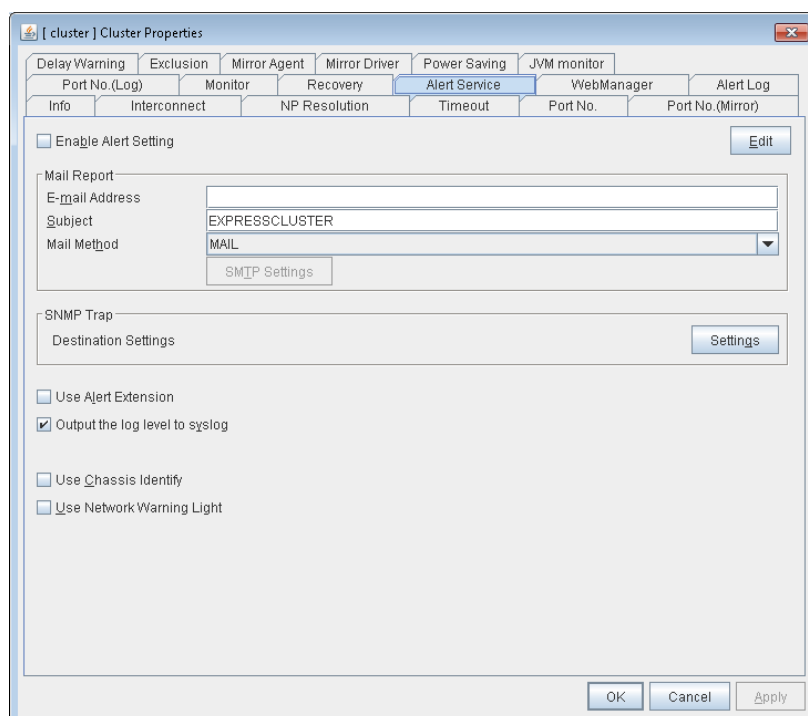

### Enable Alert Setting

Configure whether to modify the alert destination from the default value. To modify the alert report destination, click **Edit** to configure the address.

By canceling **Enable Alert Setting**, the modified destination turns to the default value temporarily.

For details about the default alert destination, see “SNMP trap messages reported by syslog, alert, and mail” in Chapter 12, “Error Messages” in this guide.

### E-mail Address (Within 255 bytes)

Enter the e-mail address to which the report is sent. If more than two e-mail addresses are set, delimit the address by semicolon.

### Subject (Within 127 bytes)

Enter the subject title for the e-mail message.

**Mail Method**

Configure the methods to send mail.

- **MAIL**  
This method uses the `mail` command. Check that a mail is sent to the mail address by using the `mail` command in advance.
- **SMTP**  
This method allows for sending mail by directly communicating with the P server.

**Destination Settings**

Configure the SNMP trap transmission function. Click **Setting** to configure the SNMP trap transmission destination.

**Use Alert Extension**

Configure whether or not to execute an optional command when EXPRESSCLUSTER sends an alert. To use the Alert Extension function, select the **Enable Alert Setting check box** and then click **Edit** to configure the command.

By canceling **Enable Alert Setting**, the configured command is temporarily disabled

**Output Log Level to syslog**

Add Log Level to the syslog messages which EXPRESSCLUSTER put out while it is in operation.

**Use Chassis Identify**

Configure whether or not to enable **Use Chassis Identify**.

**Use Network Warning Light**

Specify whether to use a network warning light (specified by NEC) controlled by network. Enter an IP address in server properties.

### Change Alert Destination

Click **Edit** to display the **Change Alert Destination** dialog box.

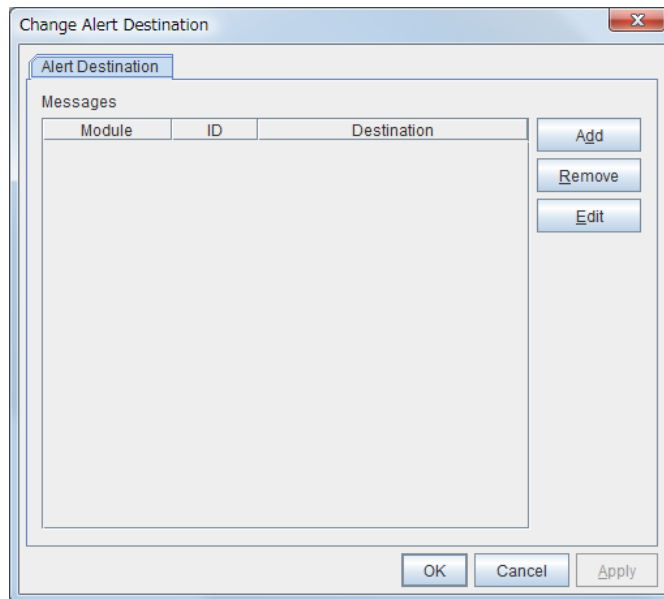

### Add

Click this to select the event ID and the module type for which you want to customize the report destinations. Click **Add** to open the **Enter the Message** dialog box.

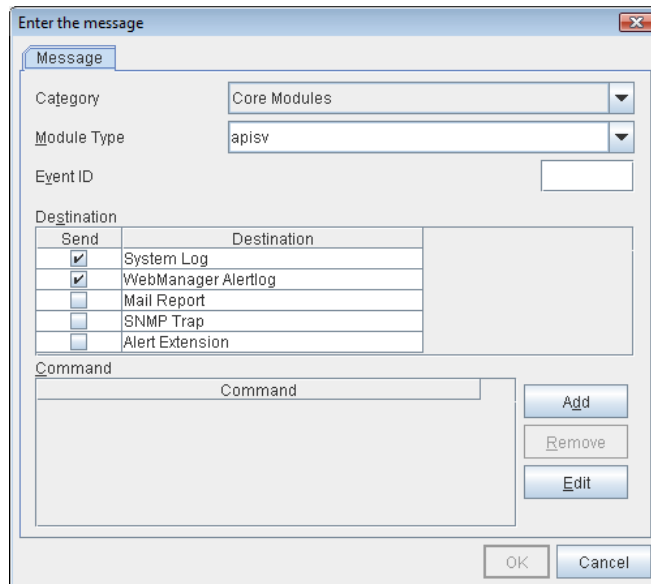

### Category

Select a major category of the module type.

**Module Type (Within 31 bytes)**

Select the name of module type that you want to change the destination address.

**Event ID**

Enter the event type of the module type for which you want to change the destination address. For details about the event ID, see “SNMP trap messages reported by syslog, alert, and mail” in Chapter 12, “Error Messages” in this guide.

**Destination**

Select the destination.

- **System Log**  
This sends message to syslog of the OS.
- **WebManager Alertlog**  
This sends message to the alert view of the WebManager.
- **Mail Report**  
This sends message by using the mail report function.
- **Alert Extension**  
This sends message by the Alert Extension function. Modify the extension settings using **Add** and **Edit**.
- **SNMP Trap**  
Uses the SNMP trap transmission function to send messages.

**Add**

Add a command of the alert extension function. Click **Add** to open the **Enter Command** dialog box. Up to 4 commands can be registered with one event ID.

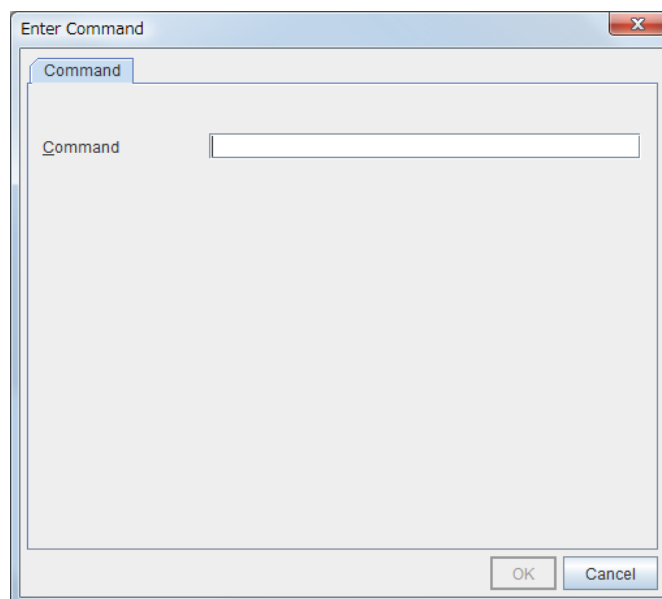

**Command (Within 511 bytes)**

Enter a command such as SNMP trap to execute reporting with the absolute path. The execution results of the specified command cannot be shown.

- **Keyword**  
If you specify %%MSG%%, the body message of the target event ID is inserted.  
You cannot specify multiple %%MSG%% for one command.  
Configure within 511 bytes including the description of %%MSG%%. Since blank characters can be included in %%MSG%%, if you specify this for an argument of commands, specify this as "%%MSG%%".

**Configuration example**

```
/usr/local/bin/snmptrap -v1 -c HOME 10.0.0.2 0 10.0.0.1 1 0 '\n1 s "%%MSG%%"
```

**Remove**

Click this to remove a command of alert extension function. Select the command and then click **Remove**.

**Edit**

Click this to modify a command of alert extension function. Select the command and then click **Edit**.

**SMTP Settings**

Click **SMTP Settings** to display the **SMTP Settings** dialog box.

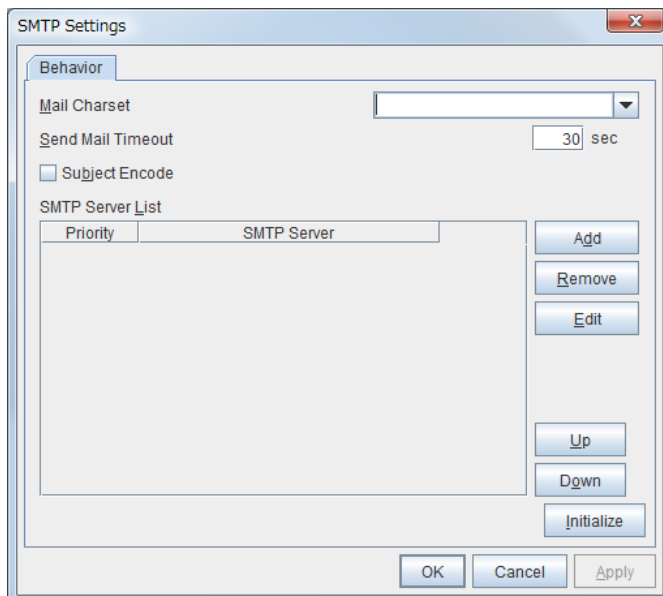

**Mail Charset (Within 127 bytes)**

Configure the character set of the e-mails sent for mail report.

**Send Mail Timeout (1 to 999)**

Configure the timeout value for communicating with the SMTP server.

**Subject Encode**

Select whether or not to encode the subject of e-mails.

**SMTP Server List**

Use this button to display a SMTP server that is configured. Four SMTP servers can be configured in this version.

**Add**

Use this button to add a SMTP server. Click **Add** to display the **Enter the SMTP Server** dialog box.

**Remove**

Use **Remove** to remove the SMTP server settings.

**Edit**

Use **Edit** to modify the SMTP server settings.

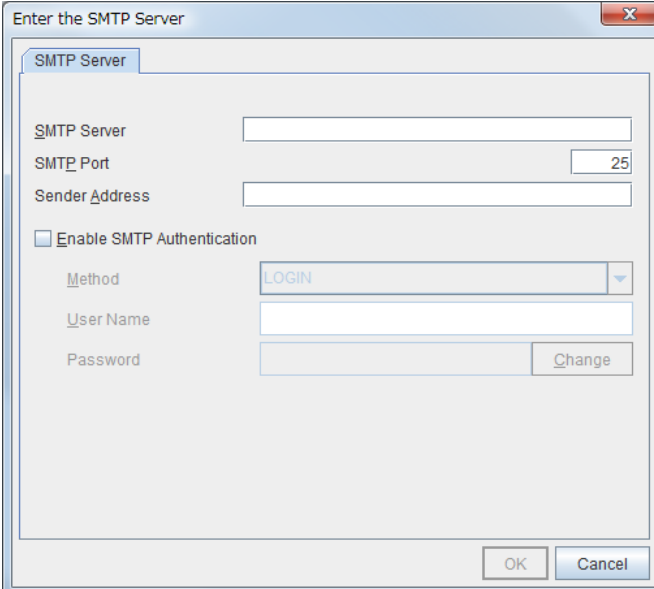

The screenshot shows a dialog box titled "Enter the SMTP Server". It contains the following fields and controls:

- SMTP Server**: A text input field.
- SMTP Port**: A text input field with the value "25".
- Sender Address**: A text input field.
- Enable SMTP Authentication**: A checkbox.
- Method**: A dropdown menu currently showing "LOGIN".
- User Name**: A text input field.
- Password**: A text input field with a "Change" button next to it.
- OK** and **Cancel**: Buttons at the bottom of the dialog.

**SMTP Server (Within 255 bytes)**

Configure the IP address or host name of the SMTP server.

**SMTP Port (1-65535)**

Configure the port number of the SMTP server.

**Sender Address (Within 255 bytes)**

Configure the address from which an e-mail of mail report is sent.

**Enable SMTP Authentication**

Configure whether or not to enable SMTP authentication.

**Method**

Select a method of SMTP authentication.

**User Name (Within 255 bytes)**

Configure the user name used for SMTP authentication.

**Password (Within 255 bytes)**

Configure the password used for SMTP authentication.

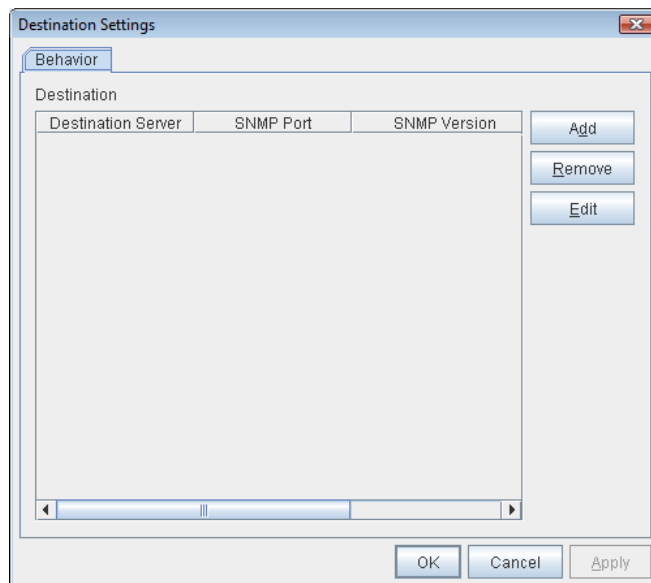

**Destination**

Displays the set SNMP trap transmission destinations. With this version, up to 255 SNMP trap transmission destinations can be set.



**Add**

Adds an SNMP trap transmission destination. Click **Add** to display the Change SNMP Destination dialog box.

**Remove**

Use **Remove** to remove the SNMP trap transmission destination settings.

**Edit**

Use **Edit** to modify the SNMP trap transmission destination settings.

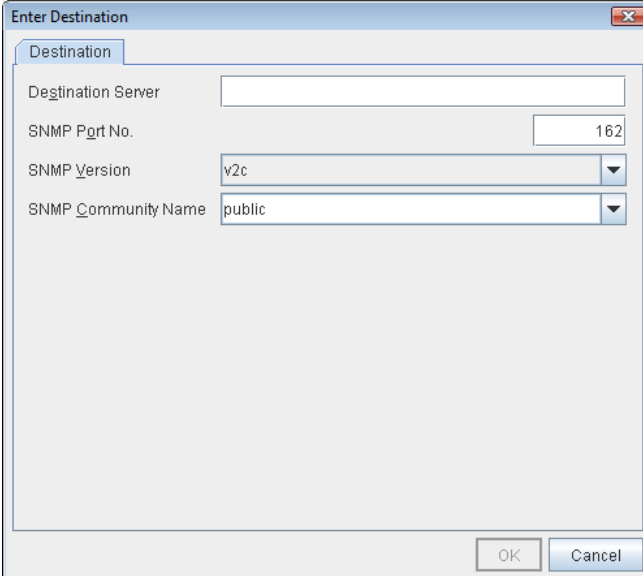

The screenshot shows a dialog box titled "Enter Destination" with a close button in the top right corner. The dialog has a tab labeled "Destination". Below the tab, there are four input fields: "Destination Server" (text input), "SNMP Port No." (text input with "162" entered), "SNMP Version" (dropdown menu with "v2c" selected), and "SNMP Community Name" (dropdown menu with "public" selected). At the bottom right of the dialog are "OK" and "Cancel" buttons.

**Destination Server (up to 255 bytes)**

Configure the name of the SNMP trap transmission destination server.

**SNMP Port (1-65535)**

Configure the port number of the SNMP trap transmission destination.

**SNMP Version**

Configure the SNMP version of the SNMP trap transmission destination.

**SNMP Community Name (up to 255 bytes)**

Configure the SNMP community name of the SNMP trap transmission destination.

## WebManager tab

Use this tab to configure the settings for the WebManager.

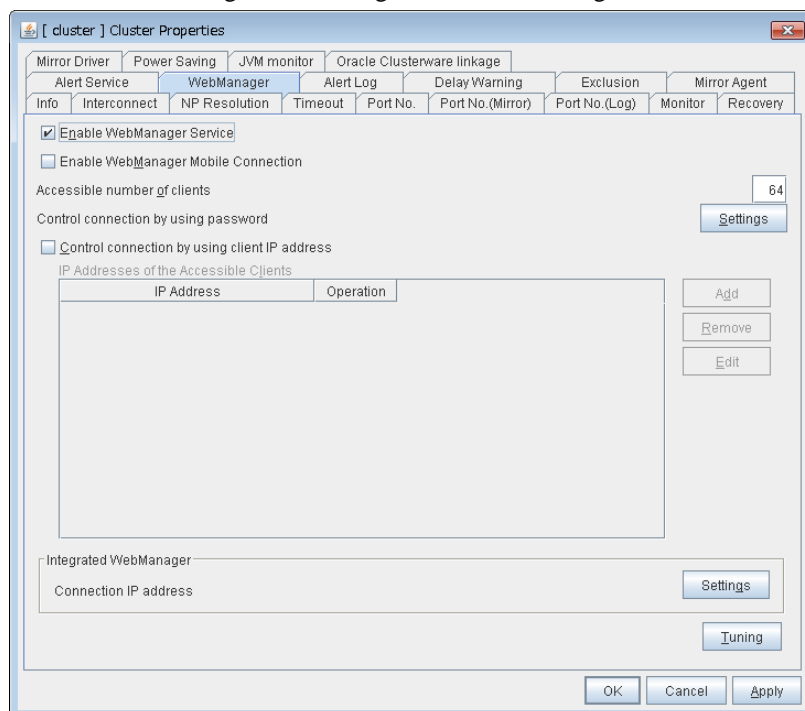

### Enable WebManager Service

Enables the WebManager Service.

- ◆ When the check box is selected:  
The WebManager service is enabled.
- ◆ When the check box is not selected:  
The WebManager service is disabled.

### Enable WebManager Mobile Connection.

- ◆ When the check box is selected:  
The WebManager Mobile is enabled.
- ◆ When the check box is not selected:  
The WebManager Mobile is disabled.

### Accessible number of clients (1 to 999)

Set the number of requests that can be simultaneously received from clients. If more requests than the number set here are generated, the excess requests will be discarded.

### Control connection by using password

Click **Settings** to display the **WebManager Password** dialog box.

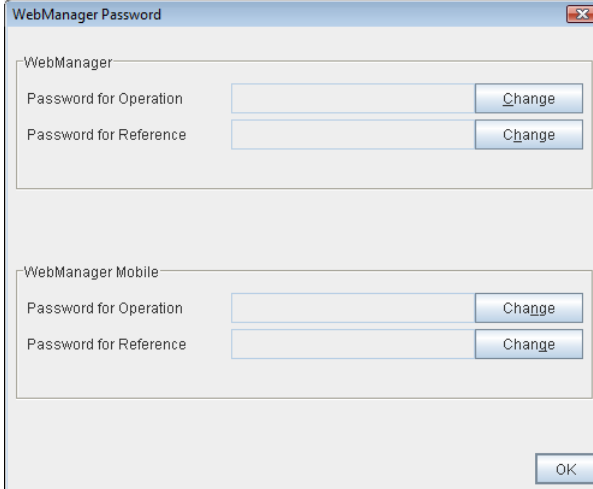

The dialog box is titled "WebManager Password" and contains two sections: "WebManager" and "WebManager Mobile". Each section has two text input fields: "Password for Operation" and "Password for Reference", each followed by a "Change" button. An "OK" button is located at the bottom right of the dialog.

#### WebManager

##### ◆ Password for Operation

Set a password that must be entered to enable connection to the WebManager in operation mode, config mode, or simulate mode.

Click **Change** to display the **Change Password** dialog box.

##### ◆ Password for Reference

Set a password that must be entered to enable connection to the WebManager in reference mode. Click **Change** to display the **Change Password** dialog box.

#### WebManager Mobile

##### ◆ Password for Operation

Set a password that must be entered to enable connection to the WebManager in operation mode.

Click **Change** to display the **Change Password** dialog box.

##### ◆ Password for Reference

Set a password to connect to the WebManager in the reference mode.

Click **Change** to display the **Change Password** dialog box.

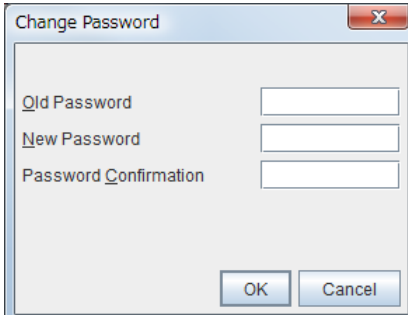

The dialog box is titled "Change Password" and contains three text input fields: "Old Password", "New Password", and "Password Confirmation". At the bottom, there are "OK" and "Cancel" buttons.

- **Old Password: (Within 255 bytes)**

Enter the current password. If the password is not set, leave it blank.

- **New Password: (Within 255 bytes)**

Enter a new password. When deleting the old password, leave it blank.

- **Password Confirmation: (Within 255 bytes)**

Enter the password again which you entered in **New Password**.

Passwords can consist of one-byte upper- and lower-case letters, digits, symbols, and spaces (0x20 to 0x7E in ASCII code).

### Control connection by using client IP address

If selected, accesses are controlled by client IP addresses.

- ◆ When the check box is selected:

**Add**, **Remove** and **Edit** are enabled.

- ◆ When the check box is not selected:

**Add**, **Remove** and **Edit** are disabled.

### Add

Use **Add** to add an IP address in **IP Addresses of the Accessible Clients**. Click **Add** to display the **IP Address Settings** dialog box. Newly added IP addresses have the rights for the operation.

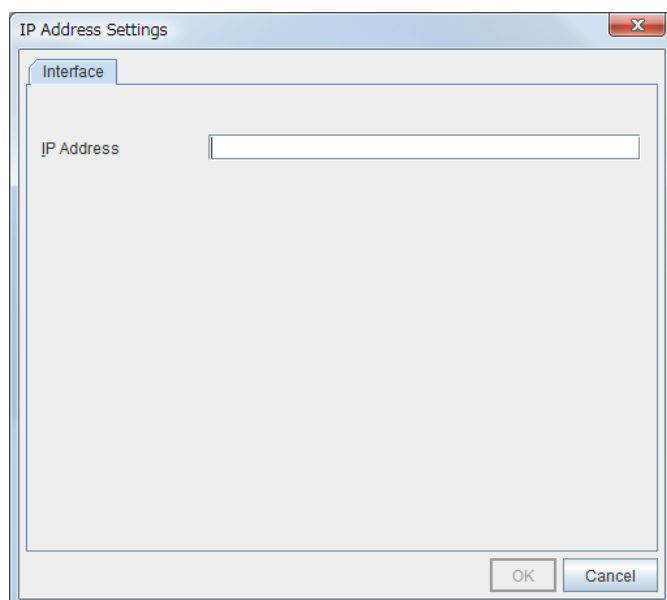

- ◆ **IP Address (Within 80 bytes)**

Specify a client IP address that can be connected.

- IP address: 10.0.0.21
- Network address: 10.0.1.0/24

### Remove

Use **Remove** to remove an IP address from **IP Addresses of the Accessible Clients**. Select the IP address to be removed from **IP Addresses of the Accessible Clients** and then click **Remove**.

### Edit

Use **Edit** to edit an IP address. Select the IP address you want to edit from **IP Addresses of the Accessible Clients** and then click **Edit**. A dialog box where the specified IP address is preset is displayed. The rights for operating the edited IP addresses remain the same.

---

**Note:** The IP addresses of the accessible clients specified here are also used to restrict connections for external operations using clprexec.

---

### Control connection by using client IP address

Sets the operation rights for IP addresses that are registered in **IP Addresses of the Accessible Clients**.

- ◆ When the check box is selected:  
A client can operate a cluster and display its status.
- ◆ When the check box is not selected:  
A client can only view the status of a cluster.

### IP address for Integrated WebManager

Click **Settings** to open the IP address dialog box for the Integrated WebManager.

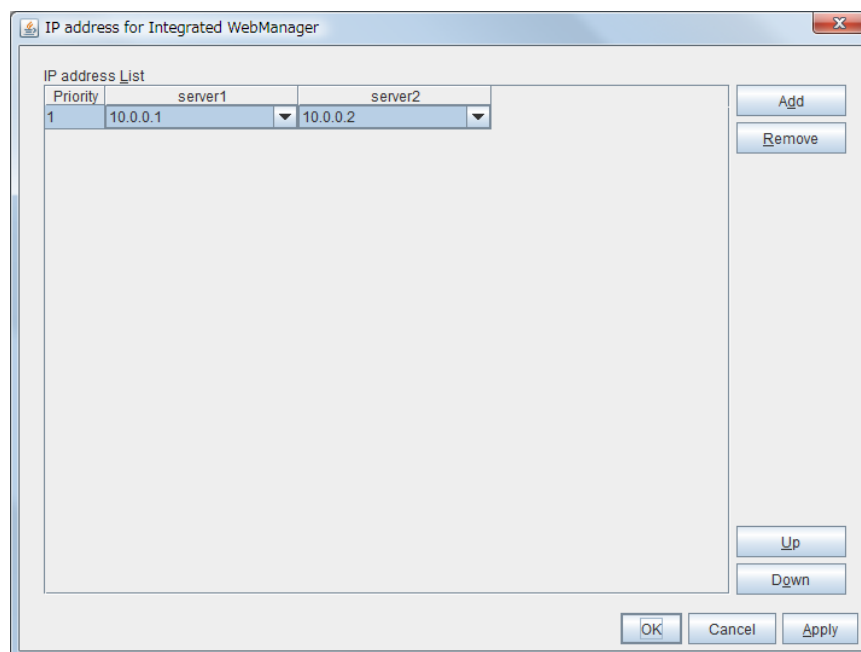

- ◆ **Add**  
Add IP addresses for the Integrated WebManager. Click the column cell of each server and select or enter IP address for the IP address of each server. For the communication path not connected to some server, set blank to the server cell of which the server is not connected.
- ◆ **Remove**  
Remove the communication path. Select the communication path to be removed and click **Remove**, then the selected path is removed.
- ◆ **Up, Down**  
When multiple IP addresses for Integrated WebManager are configured, the communication path with the smallest number in the **Priority** column is used preferentially for the internal communication among cluster servers. When changing the priority, click **Up** and **Down** to change the order of the selected row.

## Tuning

Use **Tuning** to tune the WebManager. Clicking **Tuning** displays the **WebManager Tuning Properties** dialog box.

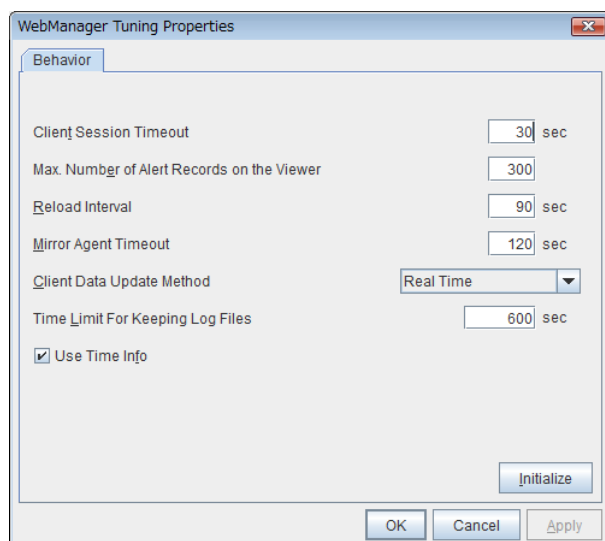

- ◆ **Client Session Timeout** (1 to 999)  
Specify the client session time-out. A time-out is determined if the time specified here elapses after the last communication between the WebManager Server and the WebManager.
- ◆ **Max. Number of Alert Records on Viewer** (1 to 999)  
Specify the maximum number of alert viewer records to display on the Alert Viewer of the WebManager.
- ◆ **Reload Interval** (0 to 999)  
Specify the screen data update interval. At this time interval, the WebManager screen is refreshed.
- ◆ **Mirror Agent Timeout** (1 to 999)  
Set the data waiting time output from the mirror agent.
- ◆ **Client Data Update Method**  
Specify how to update the data on a screen from the following options:
  - Polling  
Updates the data regularly.
  - RealTime  
Updates the data in real time.
- ◆ **Time Limit For Keeping Log Files** (60 to 43200)  
Specify the expiration period for deleting log collection information that is temporarily stored on a server. Log information on a server will be deleted if the expiration period is exceeded after the dialog box prompting saving log collection information is displayed.
- ◆ **Use Time Info Display Function**  
Specify whether the time information display function is enabled or disabled.
  - When the check box is selected:  
The time information display function is enabled.
  - When the check box is not selected:  
The time information display function is disabled.

- ◆ **Initialize**  
Click **Initialize** to reset all settings on this dialog to default. Click **Initialize** to set all the items to their default values.

## Alert Log tab

Configure the settings for the alert log.

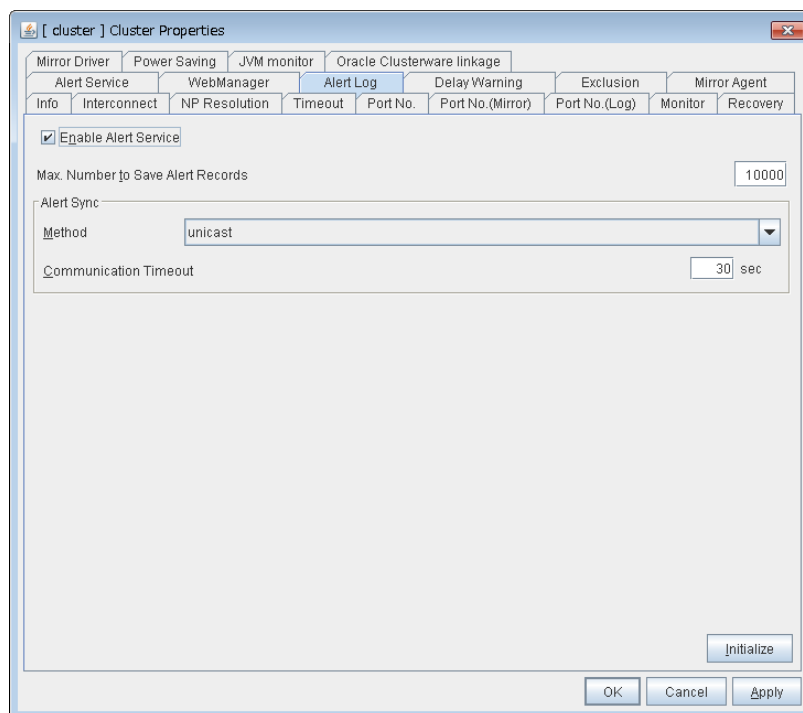

### Enable Alert Service

Select this to start alert service for the server.

- ◆ When the check box is selected:  
Alert service is enabled.
- ◆ When the check box is not selected:  
Alert service is disabled.

### Max. Number to Save Alert Records (1 to 99999)

Specify the maximum number of alert records that can be retained. Alert service for server can retain alert messages up to this number.

### Alert Sync: Method

This communication mode is used for Alert Log synchronization. Only unicast is available in **Method** list box for this version.

### Alert Sync: Communication Timeout (1 to 300)

Specify a communication time-out. A communication time-out is determined if the time specified here elapses after the last communication between Alert service and servers.

### Initialize

Click **Initialize** to reset all settings on this tab to default. Click **Initialize** to set all the items to their default values.



## Delay Warning tab

Configure the settings for Delay Warning on this tab. For details, see “Monitor resource Delay warning of monitor resources” in Chapter 5, “Monitor resource details” in this guide.

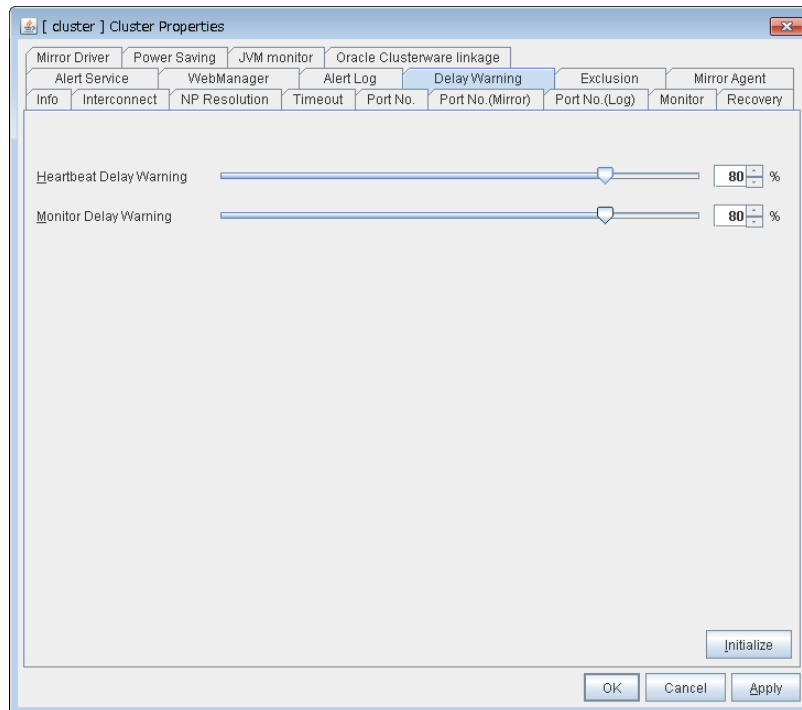

### Heartbeat Delay Warning (0 to 100)

Set a percentage of heartbeat time-out at which the heartbeat delay warning is issued. If the time for the percentage passes without any heartbeat response, the warning will be produced in an alert log. If you set 100, the warning will not be issued.

### Monitor Delay Warning (0 to 100)

Set a percentage of monitor time-out at which the monitor delay warning is issued. If the time for the percentage passes without any monitor response, the warning will be produced in an alert log. If you set 100, the warning will not be issued.

#### Note:

If you specify 0% for the delay warning, an alert log is shown in every heartbeat interval and monitor interval. Setting 0% allows you to see the time spent for monitoring. This will be helpful particularly in a test operation. Make sure not to set low values such as 0% in the production environment.

## Exclusion tab

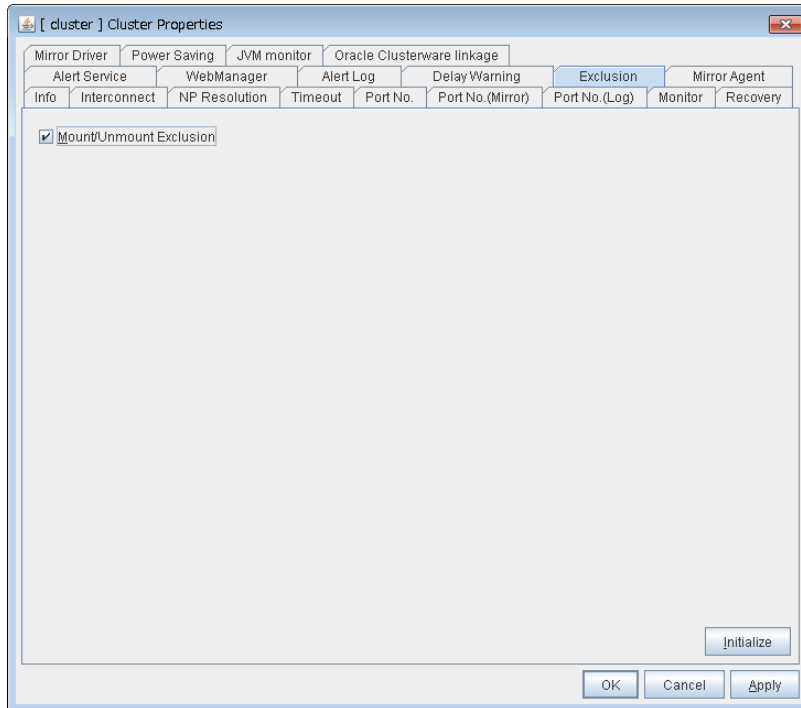

### Mount/Unmount Command Exclusion

Specify the exclusion of mount and unmount of the file systems executed in disk resource, mirror disk resource, hybrid disk resource, NAS resource and VxVOL resource. If this option is selected, problems such as mount or unmount command failure can be avoided due to the `/etc/mounttab` lock. It may take time to activate and deactivate a resource if there are many resources because mount and unmount processes are executed in order.

- ◆ When the check box is selected:
  - The exclusion is performed.
- ◆ When the check box is not selected:
  - The exclusion is not performed.

### Initialize

Use **Initialize** to reset the values to the default value. Clicking **Initialize** sets all the items to their default values.

## Mirror Agent tab ~ For the Replicator/Replicator DR~

Configure the settings for the Mirror Agent on this tab.

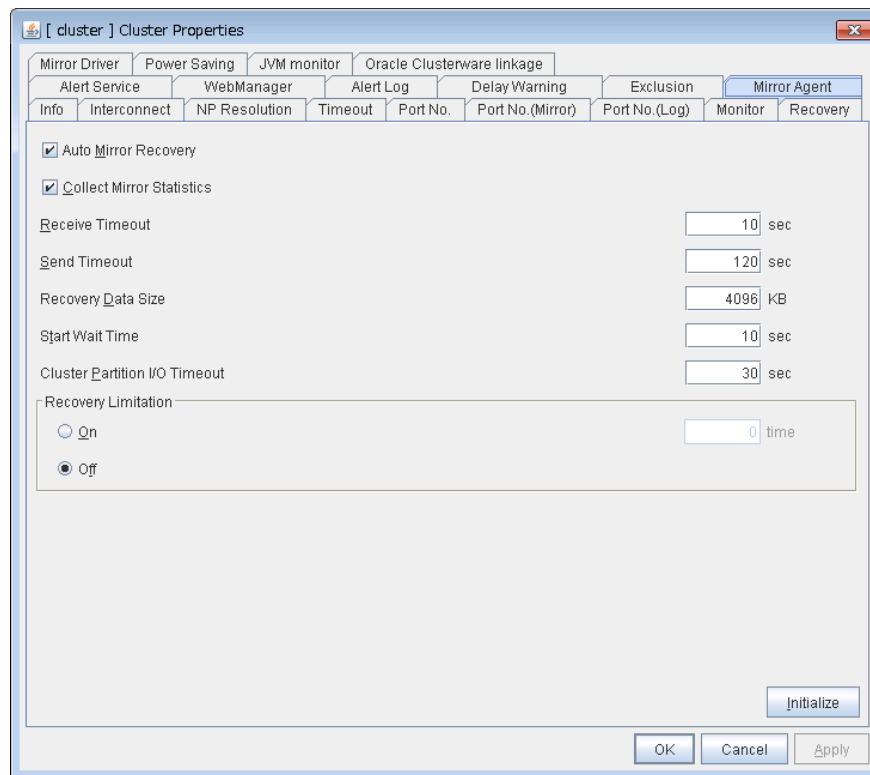

### Auto Mirror Recovery

When the check box is selected, the mirror recovery is automatically performed if there is any difference between mirror disks on both servers. In some cases, you cannot perform the auto-mirror recovery even if this is selected. For details, see “Troubleshooting Automatically recovering from mirroring” in Chapter 11, “Troubleshooting” in this guide.

- ◆ When the check box is selected:
  - The mirror recovery is automatically performed.
- ◆ When the check box is not selected:
  - The mirror recovery is not automatically performed.

### Collect Mirror Statistics

This function can be used to collect and reference information about the mirroring performance. For details, see “Mirror statistics information collection function” in Chapter 10, “The system maintenance information” in this guide.

- ◆ When the check box is selected
  - Mirror Statistics Collection is performed.
- ◆ When the check box is not selected
  - Mirror Statistics Collection is not performed.

**Receive Timeout (1 to 600)**

Set the time-out for the Mirror Agent waiting to receive data after establishing the connection.

**Send Timeout (1 to 600)**

Set the time-out for the Mirror Agent to send data to the Mirror Agent of the other server and wait it to be processed.

**Recovery Data Size (64 to 32768)**

Specify the recovery data size.

**Start wait time (10 to 600)**

For using a hybrid disk resource in a shared disk, set the waiting time to synchronize the starts of the servers connected to the shared disk. If another server does not start within the time configured here, the current right is obtained temporarily.

**Cluster partition I/O timeout (5 to 300)**

For using hybrid disk resource, set the timeout value for accessing the cluster partition.

- The time-out value must be smaller than the heartbeat time-out specified at the **Timeout** tab.

**Recovery Limitation**

Specify the retry count to perform mirror recovery again if the data has been updated during a mirror recovery.

◆ On (1 to 100)

The mirror recovery retry is performed the times specified on the box.

◆ Off

When there is update data, mirror recovery is performed until there is no difference.

**Initialize**

This is used to reset the values to the default value. Clicking **Initialize** sets all the items to their default values.

## Mirror driver tab ~ For Replicator/Replicator DR ~

Configure the settings for the mirror driver on this tab.

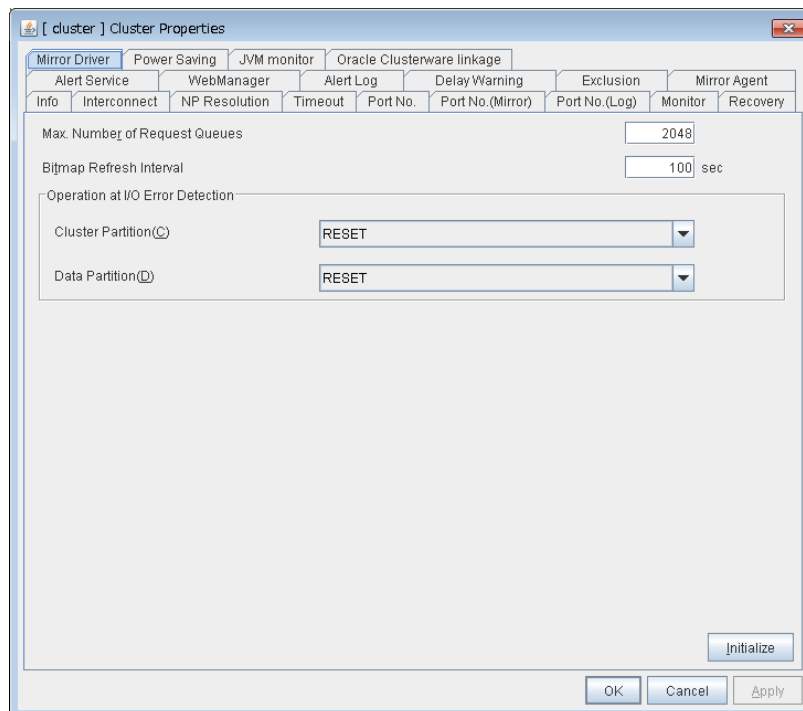

### Max. Number of Request Queues (256 to 65535)

Set the number of queues for mirror disk driver for queuing I/O requests from the upper system.

### Bitmap Refresh Interval (1 to 600)

Set the interval to check if the standby system writes the bitmap difference.

### Initialize

Use **Initialize** to reset the values to the default value. Click **Initialize** to set all the items to their default values.

### Action when an I/O error is detected

- ◆ Cluster Partition
  - Set an operation when an I/O error occurs in a cluster partition.
- ◆ Data Partition
  - Set an operation when an I/O error occurs in a data partition.

## Power saving tab

Configure whether or not to use the function to turn it to power-saving mode by controlling the CPU frequency of the standby server.

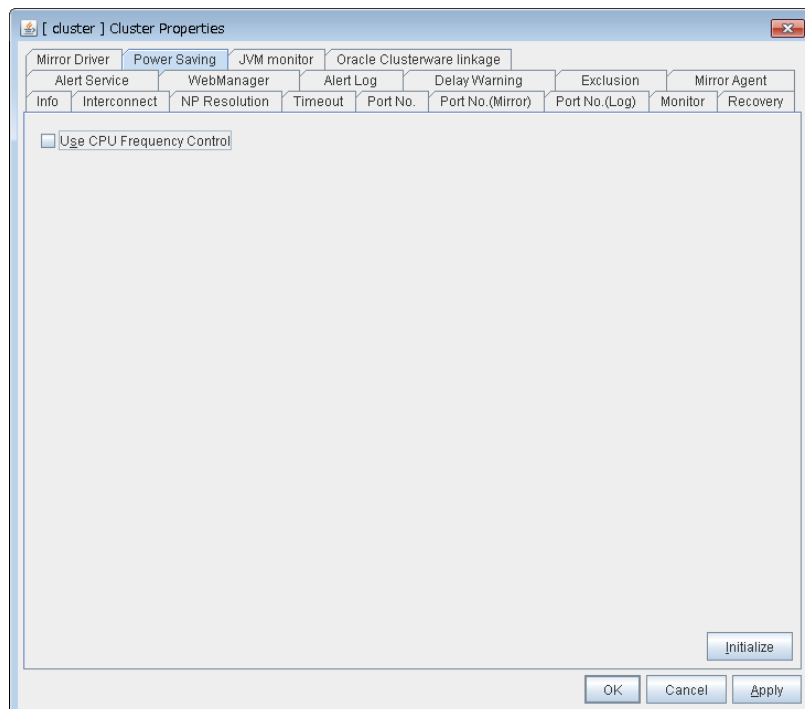

### Use CPU Frequency Control

Select the check box when you use CPU frequency control.

When CPU frequency control is used, the CPU frequency of the server where a failover group is activated is set to high, and that of the server where a failover group is stopped is set to low.

When CPU frequency control is performed by a command or WebManager, the settings changed by the command or WebManager are given higher priority regardless of whether the failover group is started or stopped. Note that the settings changed by the command or WebManager is discarded after the cluster is stopped/started or suspended/resumed, so that CPU frequency is controlled by the cluster.

- ◆ When the check box is selected  
CPU frequency control is performed.
- ◆ When the check box is cleared  
CPU frequency control is not performed.

### Initialize

Use this to restore the initial value. Click **Initialize** to set all the items to their default values.

---

### Note:

For using CPU frequency control, it is required that the frequency is changeable in BIOS settings and the CPU supports the frequency control by OS power management function and that kernel is supported.

---

## JVM monitor tab

Configure detailed parameters for the JVM monitor.

### NOTE:

To display the **JVM monitor** tab on the online version Builder, you need to execute **Update Server Info** from the **File** menu after the license for Java Resource Agent is registered.

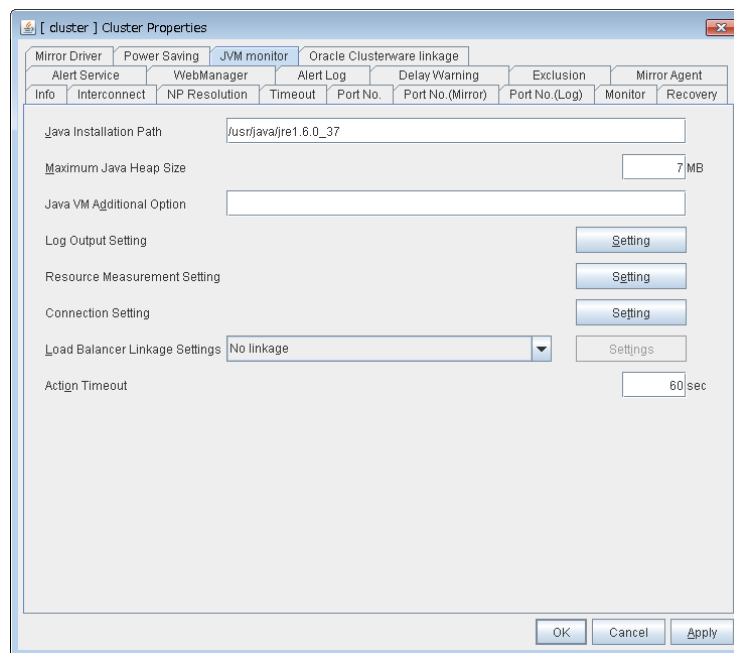

#### Java Installation Path (up to 255 bytes)

Set the Java VM install path used by the JVM monitor. Specify an absolute path using ASCII characters. Do not add “/” to the end of the path. This setting becomes common for all servers in the cluster. Specification example: /usr/java/jre1.6.0\_37

#### Maximum Java Heap Size (7 to 4096)

Set, in megabytes, the maximum Java VM heap size used by the JVM monitor (equivalent to `-Xmx` of the Java VM startup option). This setting becomes common for all servers in the cluster. If using Oracle’s Java, specify a value equal to or larger than 7.

#### Java VM Additional Option (up to 1024 bytes)

Set the Java VM startup option used by the JVM monitor. However, specify `-Xmx` in the [Maximum Java Heap Size]. This setting becomes common for all servers in the cluster. Specification example: `-XX:+UseSerialGC`

#### Log Output Setting

Click the Setting button to open the Log Output Setting dialog box.

**Resource Measurement Setting**

Click the Setting button to open the Resource Measurement Setting dialog box.

**Connection Setting**

Click the **Setting** button to open the **Connection Setting** dialog box.

**Load Balancer Linkage Settings**

Select the load balancer type and then click the **Settings** button. The **Load Balancer Linkage Settings** dialog box appears.

Select the load balancer type from the list. To perform load balancer linkage, select the load balancer you are using. To cancel the load balancer linkage, select **No linkage**.

**Action Timeout (30 to 300)**

Set the timeout value of [Command] specified in each window of the JVM monitor. This setting becomes common for all the [Command] items.



## Log Output Setting

Clicking **Setting** displays the **Log Output Setting** dialog box.

### Log Level

Select the log level of the log output by the JVM monitor.

### Generation (2 to 100)

Set the number of generations to be retained for log output by the JVM monitor.

### Rotation Type

Select a rotation type for the log output by the JVM monitor. If you select **File Capacity** as the rotation type, set the maximum size (200 to 2097151), in kilobytes, for each log file such as the JVM operation log. If you select **Period** as the rotation type, set the log rotation start time in “hh:mm” format (hh: 0 to 23, mm: 0 to 59) and the rotation interval (1 to 8784) in hours.

### Initialize

Clicking **Initialize** returns the log level, generation, and rotation type items to their default values.

### Resource Measurement Setting [Common]

Clicking **Setting** displays the **Resource Measurement Setting** dialog box. For details about the scheme for error judgment by the JVM monitor, see Chapter 5, “Monitor resource details”.

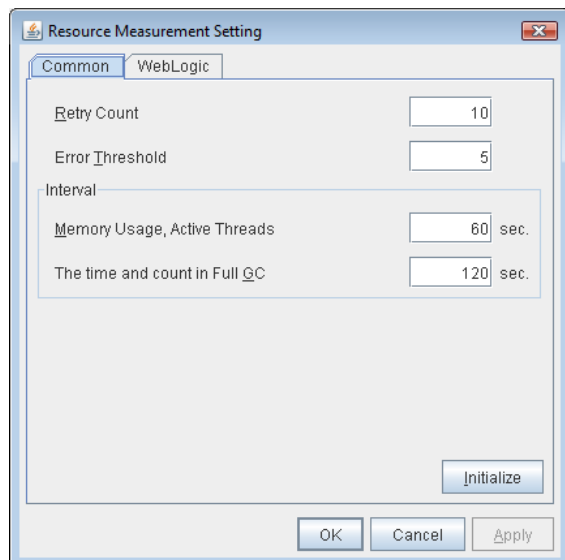

#### Retry Count (1 to 1440)

Set a resource measurement retry count to be applied if the JVM monitor fails in resource measurement.

#### Error Threshold (1 to 10)

Set the number of times abnormal judgment is performed when the usage of the Java VM or the application server resources collected by the JVM monitor via resource measurement continuously exceed the customer-defined threshold.

#### Memory Usage, Active Threads (15 to 600)

Set the interval at which the JVM monitor measures the memory usage and active thread count.

#### The time and count in Full GC (15 to 600)

Set the **interval** at which the JVM monitor measures the time and count in Full GC execution.

#### Initialize

Clicking **Initialize** returns the retry count, error threshold, and interval items to their default values.

### Resource Measurement Setting [WebLogic]

Clicking **Setting** displays the **Resource Measurement Setting** dialog box. For details about the scheme for error judgment by the JVM monitor, see Chapter 5, “Monitor resource details”.

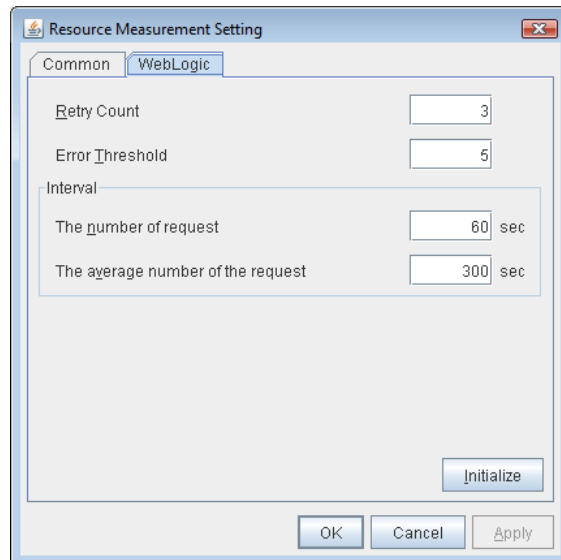

#### Retry Count (1 to 5)

Set the resource measurement retry count to be applied if the JVM monitor fails in resource measurement.

#### Error Threshold (1 to 10)

Set the number of times abnormal judgment is to be performed when the usage of the Java VM or the application server resources collected by the JVM monitor via resource measurement continuously exceed the customer-defined threshold.

#### The number of request (15 to 600)

Set the interval at which the JVM monitor measures the number of work manager or thread pool requests during WebLogic monitor.

#### The average number of the request (15 to 600)

Set the interval at which the JVM monitor measures the average number of work manager or thread pool requests during WebLogic monitor. Set a value that is an integer multiple of the value set in **The number of request**.

#### Initialize

Clicking **Initialize** returns the retry count, error threshold, and interval items to their default values.

### Connection Setting

Clicking **Setting** displays the Connection Settings dialog box.

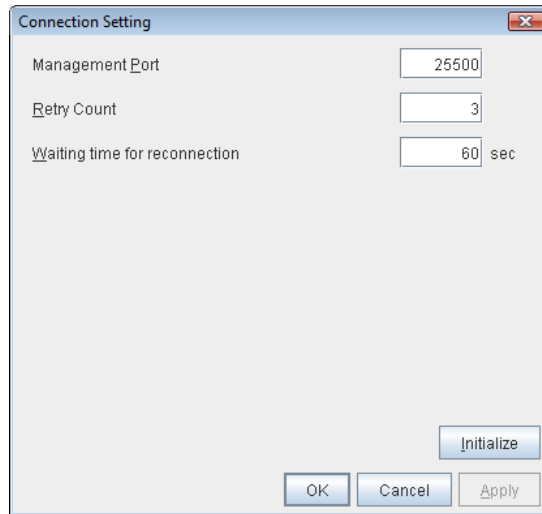

#### Management Port (10000 to 65535)

Set the number of the port connected to the monitor target Java VM. This setting becomes common for all the servers in the cluster. Do not set 32768 to 61000.

#### Retry Count (1 to 5)

Set the retry count to be applied if connection to the monitor target Java VM fails.

#### Waiting time for reconnection (15 to 60)

Set the interval at which the JVM monitor retries connection if it fails in Java VM connection.

#### Initialize

Clicking **Initialize** sets the management port, retry count, and wait time for reconnection items to their default values.

### Load Balancer Linkage Settings

If you select other than BIG-IP LTM as the load balancer type and then click the **Settings** button, the **Load Balancer Linkage Settings** dialog box appears.

#### Management Port for Load Balancer Linkage (10000 to 65535)

Set the port number used by the load balancer linkage function. This setting becomes common to all the servers in the cluster. Do not set 32768 to 61000.

#### Health Check Linkage Function

Set whether to use the load balancer health check function if the monitor target Java VM detects a failure.

#### Directory containing HTML files (up to 1023 bytes)

Set the directory in which the HTML file used by the load balancer health check function is stored. Specify an absolute path using ASCII characters. Do not add “/” to the end of the path.

#### HTML File Name (up to 255 bytes)

Set the HTML file name used by the load balancer health check function. Specify this filename using ASCII characters.

#### HTML Renamed File Name (up to 255 bytes)

Set the HTML renamed file name used by the load balancer health check function. Specify this file name using ASCII characters. Specify an HTML renamed file name that is different from the HTML file name.

#### Retry count for renaming (0 to 5)

Set the number of times HTML file renaming is retried if it fails.

**Wait time for retry (1 to 60)**

Set the interval at which HTML file renaming is retried if it fails.

**Initialize**

Clicking **Initialize** returns the management port for load balancer linkage, health check linkage function, directory containing HTML files, HTML file name, HTML renamed file name, retry count for renaming and wait time for retry items to their default values.

**Load Balancer Linkage Settings**

Select BIG-IP LTM as the load balancer type and then click the **Settings** button. The **Load Balancer Linkage Settings** dialog box appears.

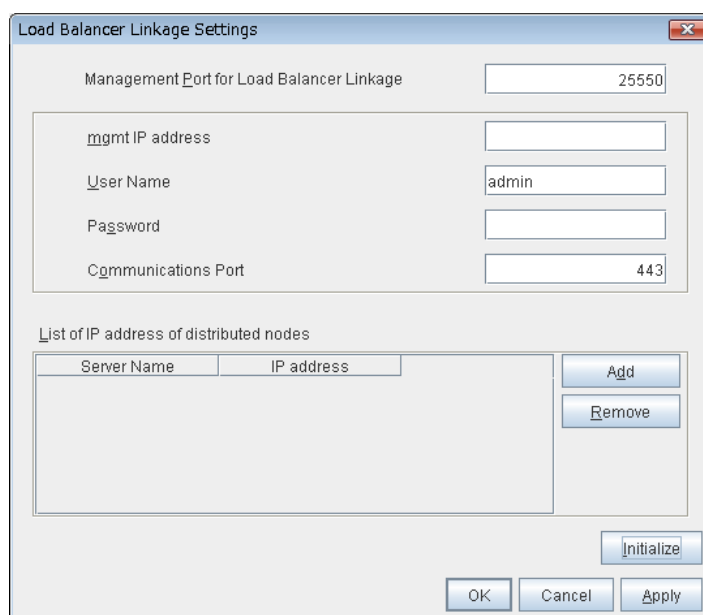

**Management Port for Load Balancer Linkage (10000 to 65535)**

Set the port number used by the load balancer linkage function. This setting becomes common to all the servers in the cluster. Do not set 42424 to 61000.

**mgmt IP address**

Set the BIG-IP LTM IP address.

**Management User Name (up to 255 bytes)**

Set the BIG-IP LTM management user name.

**Password (up to 255 bytes)**

Set the BIG-IP LTM management user password.

**Communications Port (10000 to 65535)**

Set the communication port number for BIG-IP LTM.

**Add**

Add the server name and IP address for the distributed node. For the server name, specify the EXPRESSCLUSTER server name. For the IP address, specify the value set to **Members** in **LocalTraffic - Pools:PoolList – Relevant pool - Members** of BIG-IP Configuration Utility. To change the value, select the line and directly edit the description.

**Remove**

Remove the server name and IP address for the distributed node. Select the line to be removed and then click **Remove**. The selected server is removed.

**Initialize**

Clicking **Initialize** returns the management port for load balancer linkage, management user name, and communication port number to the default settings.

## **Oracle Clusterware linkage tab**

It can't be used.



## Server properties

Configure individual settings on each server constructing the cluster in Server Properties.

### Info tab

You can display the server name and make a change to a comment on this tab.

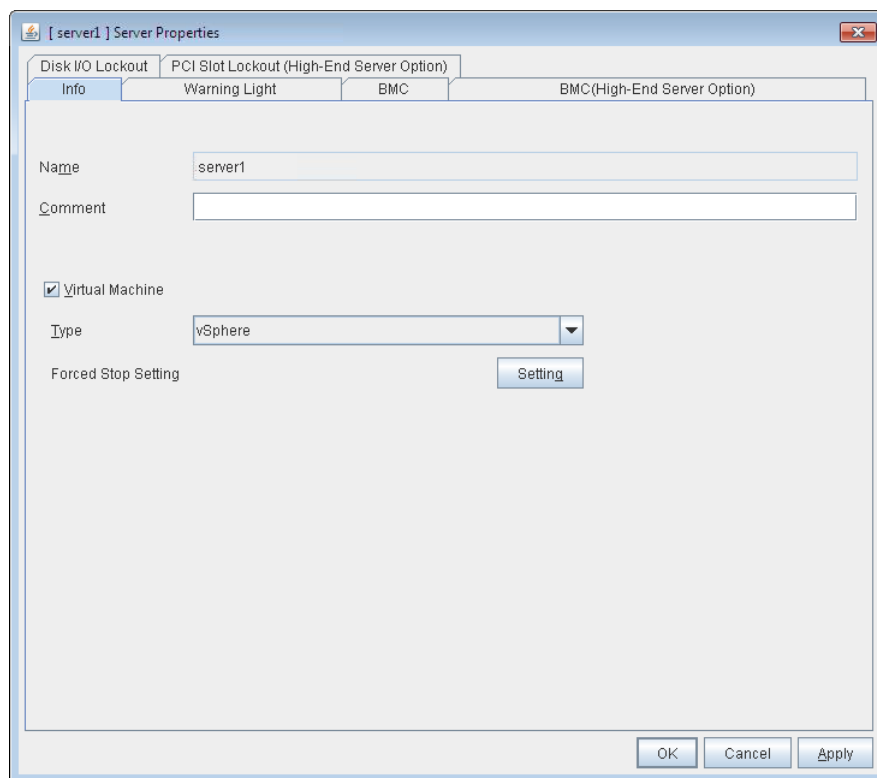

#### Name

The selected server name is displayed. You cannot change the name here.

#### Comment (Within 127 bytes)

You can specify a comment for the server. Only alphanumeric characters are allowed.

#### Virtual Machine

Specify whether this server is a virtual machine (guest OS).

- ◆ On
  - If selected, the server is a virtual machine (guest OS). You can configure this virtual machine.
- ◆ Off
  - If selected, the server is a physical machine. You cannot configure a virtual machine.

### Type

Specify the type of virtual infrastructure.

- vSphere  
Virtual infrastructure provided by VMware, Inc.
- KVM  
Linux kernel virtual infrastructure.
- XenServer  
Virtual infrastructure provided by Citrix Systems, Inc.
- Container  
Virtual infrastructure provided by Oracle Systems, Inc.
- Hyper-V  
Virtual infrastructure provided by Microsoft Corporation.
- other  
Specify this option to use any other virtual infrastructure.

### Forced Stop Setting

Set the information about the virtual machine (guest OS). Click **Setting** to display the **Input for Virtual Machine name** dialog box.

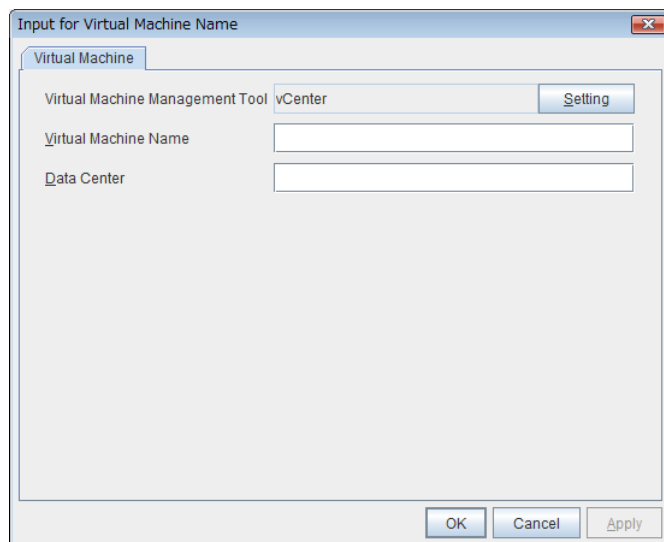

### Virtual Machine name (Within 80 bytes)

Set the virtual machine (guest OS) name.

---

#### Note:

Do not use a double quotation mark (") or percent sign (%) in the virtual machine name.

---

**Data Center (Within 80 bytes)**

Set the name of the data center that manages the virtual machine (guest OS).

---

**Note:**

Do not use a double quotation mark (") or percent sign (%) in the virtual machine name.

---

**vCenter**

Set the vCenter server that manages the virtual machine (guest OS). Click **Setting** to display the **Virtual Machine Forced Stop Setting** dialog box.

For more information on **Virtual Machine Forced Stop Setting**, refer to the description of the **Recovery** tab.

## Warning Light tab

Set an IP address of warning light (specified by NEC) controlled by network.

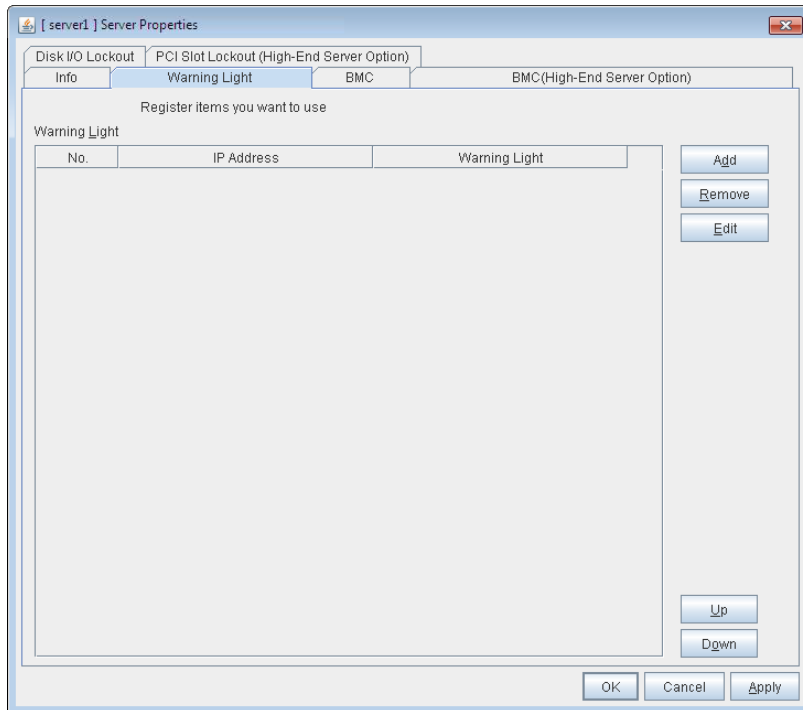

### Add

Use **Add** to add an interface. Clicking **Add** displays the **Warning Light Settings** dialog box.

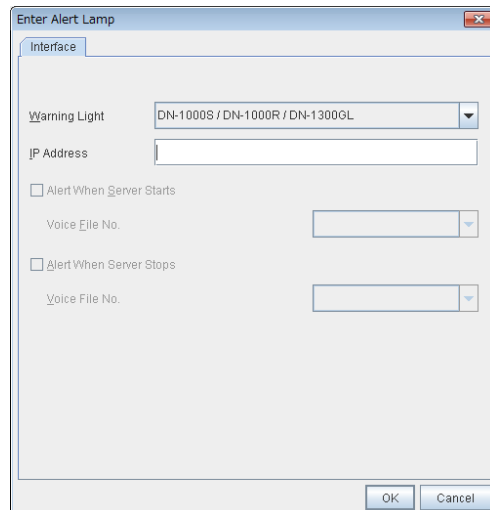

◆ **IP Address** (Within 80 bytes)

Enter an IP address of the warning light.

**Note:**

One warning light is required per one server. Do not set an IP address of the same warning light to multiple servers.

### ◆ Warning Light

Select the product number of the warning light you use. The products corresponding to each number are as follows.

Product Number	Product Name
DN-1000S/DN-1000R/DN-1300GL	DN-1000S/DN-1000R/DN-1300GL
DN-1500GL	DN-1500GL
NH-FB series/NH-FB1 series	NH-FB series/NH-FB1 series
NH-FV1 series	NH-FV1 series

### ◆ Playback of an audio file

Playback of an audio file is enabled when DN1500GL or NH-FV1 series is selected as the warning light type.

If you change the warning light type to other than DN1500GL or NH-FV1 series after playback of an audio file was enabled, playback of an audio file will be disabled.

#### Alert When Server Starts

- ◆ When the check box is selected:  
Reproduces the audio file at server start. The audio file is reproduced only once.
- ◆ When the check box is not selected:  
Does not reproduce the audio file at server start.
- ◆ Voice File No. (DN1500GL:01 to 20, NH-FV1 series: 01 to 70)  
Set the number of the voice file to be played when the server starts

#### Alert When Server Stops

- ◆ When the check box is selected:  
Reproduces the audio file at server stop. The audio file is continuously reproduced until it is stopped manually.
- ◆ When the check box is not selected:  
Does not reproduce the audio file at server stop.
- ◆ Voice File No. (DN1500GL:01 to 20, NH-FV1 series: 01 to 70)  
Set the number of the voice file to be played when the server stops.

#### Edit

Use **Edit** to edit the warning light setting.

---

**Note:** To play back the audio file, it must be registered in the network warning light.

For more information on audio file registration, refer to the instruction manual of the network warning light to be used.

---

---

Set the audio file number corresponding to the audio file that is registered for the network warning light.

---

## BMC tab

Configure a LAN port for managing BMC when using the forced stop and the chassis identify.  
Configure one for each server.

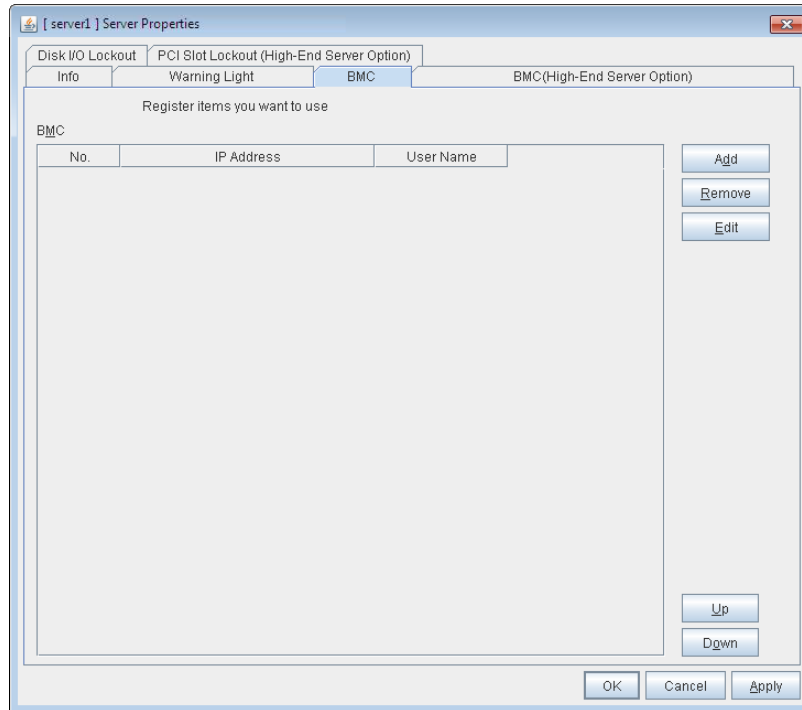

### Add

Use this button to newly configure a server. Click **Add** to opens the **BMC Settings** dialog box.

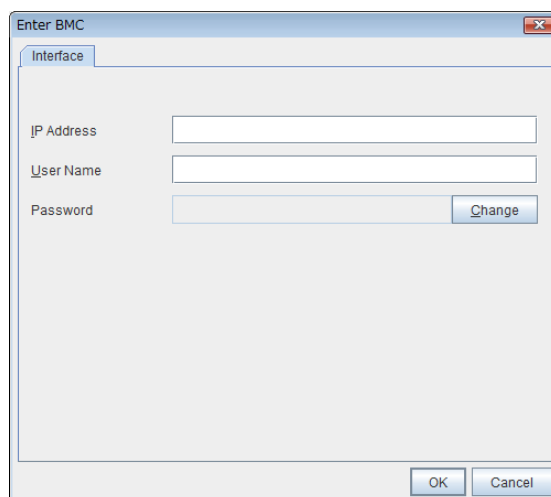

- ◆ IP Address (**Within** 80 bytes)

Enter the IP address set for the LAN port for managing BMC.

- ◆ **User Name (Within 255 bytes)**

Enter the user name with administrator privilege from the user names configured in BMC.

If you do not enter anything, the argument of user name is not configured when the `ipmitool` command, the `hwreset` command, the `alarms` command, the `ireset` command or the `ialarms` command is executed.

The valid length of user name varies depending on the `ipmitool` command, the `hwreset` command, the `alarms` command, the `ireset` command or the `ialarms` command and the specification of BMC of the server.

- ◆ **Password (Within 255 bytes)**

Enter the password of the user configured above.

The valid length of password varies depending on the specifications of `ipmitool` command, `hwreset` command, , the `alarms` command, the `ireset` command or the `ialarms` command and the BMC of the server.

For more information on user name and password, refer to the manual of the server.

### **Remove**

Use this button to remove the settings. Select the target setting, and then, click **Remove**.

### **Edit**

Use this button to modify the settings. Select the target setting, and then, click **Edit**. The **BMC Settings** dialog box is displayed.

When a cluster consists of the different types of servers and includes a server which does not have BMC function, do not configure the **BMC** tab for the server.

In such a configuration, if **Chassis Identify** and/or the forced stop function, the alert telling you “failed in the BMC action” is displayed.



## **BMC(High-End Server Option) tab**

It can't be used.

## Disk I/O Lockout tab

Configure the settings for disk I/O lockout devices.

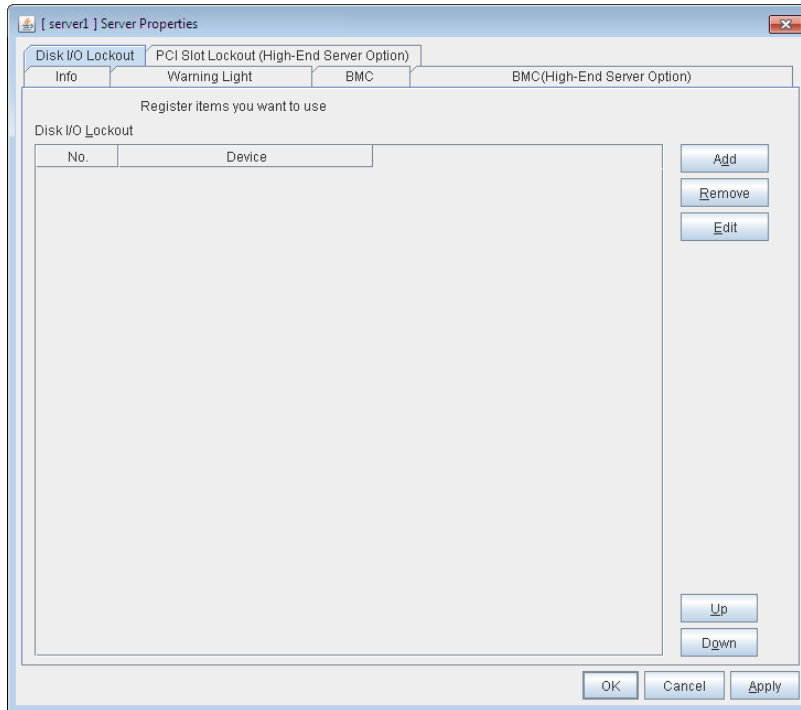

### Add

Use **Add** to add lockout devices. Clicking **Add** displays the **Enter the device name** dialog box.

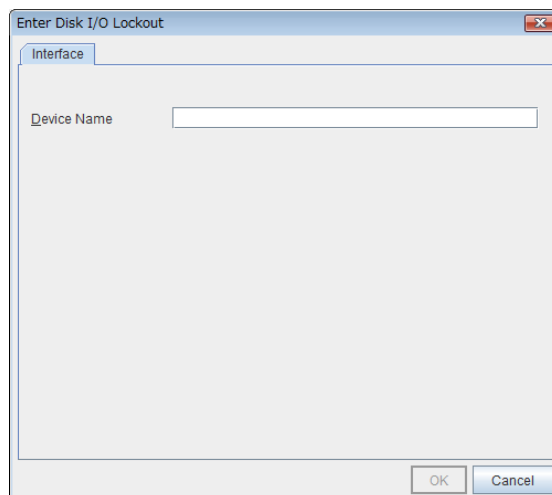

- ◆ Device Name (Within 1023 bytes)  
Enter a disk I/O lockout device.

**Remove**

Use **Remove** to remove lockout devices. Select the device to remove from the **Disk I/O Lockout** device and then click **Remove**.

**Edit**

Use **Edit** to edit disk I/O lockout devices. Clicking **Edit** opens the **Enter the device name** dialog box.

**UP & Down**

Use **UP & Down** to change the I/F number. Select the I/F you want to change from the I/F list and then click **Up** or **Down**. The selected row moves up and down accordingly.

## **PCI Slot Lockout(High-End Server Option) tab**

It can't be used.

## Functional differences of the Builder between Linux and Windows

### Reading and writing the cluster configuration data

Only for Linux, you can select a file format to read/write data in a floppy disk.

For details, see “File menu” on page 154.

Select the **File** menu to display the following pull-down menu.

Menu	Functional overview
<b>New</b>	Creates a cluster.
<b>Cluster Generation Wizard</b>	Opens the cluster generation wizard.
<b>Open</b>	Opens the configuration file.
<b>Save</b>	Saves the configuration file.
<b>Get the Configuration File</b>	Gets the configuration file applied to the cluster.
<b>Apply the Configuration File</b>	Applies and applies the configuration file to the cluster.
<b>Option</b>	Opens the <b>Option</b> dialog box.
<b>Collect logs</b>	Opens the <b>Collect Logs</b> dialog box.
<b>Stop</b>	Exits the Builder.

### Script editor for exec resources

The default script editor is vi editor for Linux, and Notepad for Windows. Default settings on Linux use xterm for terminal, therefore, multi-byte characters cannot be properly displayed. For details, see “Understanding EXEC resources – Displaying and changing the EXEC resource details” in Chapter 4, “Group resource details” in this guide.

## Parameters list

Parameters you can specify in the Builder and their default values are listed below.

“How to change [1]-[6]” represents the way you apply changes of parameters on servers. Applicable method is marked with “O.”

Priority	How to apply	Refer to:
1	Uploading data and shutting down, restarting a cluster	Installation and Configuration Guide Chapter 7 “Modifying the cluster configuration data”
2	Stopping a cluster, and stopping a mirror agent, and then uploading data	
3	Uploading data after stopping a cluster	
4	Uploading data after stopping a group	
5	Uploading data after stopping a resource	
6	Uploading data after suspending a cluster	
7	Uploading data after suspending a monitor	
8	Uploading data and restarting the WebManager	
9	Uploading data only	

When creating the cluster configuration data for the first time, see Chapter 5 “Creating the Cluster configuration data” in the *Installation and Configuration Guide*.

## Cluster

Parameters	Default	How to change								
		1	2	3	4	5	6	7	8	9
<b>Cluster Properties</b>										
<b>Info Tab</b>										
Cluster Name	-						O			
Comment	-									O
Language	English						O		O	
<b>Interconnect Tab</b>										
Communication Path (Add, Remove, Up, Down)	-		O							
Type							O		O	
MDC			O							
Kernel mode, User mode, IP Address							O		O	
DISK Device		O					O		O	
COM Device							O		O	
BMC IP Address							O		O	
Mirror Communication Only			O							
MDC Use			O							
Server Down Notification	On									O
<b>Disk Heart Beat Properties</b>										
Raw Device							O			
<b>Heart Beat I/F Tuning Properties</b>										
<b>DISK tab</b>										
Open/Close Timing				O						

Parameters	Default	How to change								
		1	2	3	4	5	6	7	8	9
Bind Check			0							
<b>Network Partition Resolution Definition Tab</b>										
Ping Target Server						0				
Ping NP Properties						0				
Interval	5 seconds					0				
Timeout	3 seconds					0				
Retry Count	3 times					0				
<b>Network Partition Resolution Tuning Properties</b>										
Action at NP Occurrence	Shutdown					0				
<b>MDC Tab</b>										
MDC Server			0							
Add			0							
Remove			0							
<b>Timeout Tab</b>										
Server Sync Wait Time	5 minutes									0
Heartbeat Interval	3 seconds					0				
Heartbeat Timeout	90 seconds					0				
Server Internal Timeout	180 seconds					0		0		
<b>Port No. Tab</b>										
Server Internal Port Number	29001					0		0		
Data Transfer Port Number	29002	0								
WebManager HTTP Port Number	29003								0	
Heartbeat Port Number	29002					0				
Kernel Mode Heartbeat Port Number	29006					0				
Alert Sync Port Number	29003								0	
<b>Port No. (Mirror) Tab <sup>3</sup></b>										
Mirror Agent Port Number	29004		0							
<b>Port No. (Log) Tab</b>										
Communication Method for Internal Logs	Unix Domain	0								
Port Number	-	0								
<b>Monitor Tab</b>										
Shutdown Monitor	Always execute									0
Method	softdog									0
Operation at Timeout Detection	RESET									0
Enable SIGTERM handler	Off									0
Timeout	Use Heartbeat Timeout									0
Set Timeout	90 seconds									0
Collect the System Resource Information	Off					0				
<b>Recovery Tab</b>										
Max Reboot Count	zero					0				
Max Reboot Count Reset Time	0 minute					0				
Use Forced Stop	Off									0
Forced Stop Action	BMC reset									0
Forced Stop Timeout	3 seconds									0
<b>Virtual Machine Forced Stop</b>										
Virtual Machine Management Tool	vCenter									0
Action	Power-off									0
Timeout	30 seconds									0
Command	/usr/lib/vmware-viperl/apps/vm control.pl									0
Host Name	-									0

<sup>3</sup> It does not apply to PPC64 and PPC64LE.

Parameters	Default	How to change								
		1	2	3	4	5	6	7	8	9
User Name	-									<input type="radio"/>
Execute Script for Forced Stop	Off									<input type="radio"/>
<b>Script Setting</b>										
Select User Application Enter application path (Edit)	-									<input type="radio"/>
Select Script created with this product Script content (Edit)	-									<input type="radio"/>
Timeout	10 [seconds]									<input type="radio"/>
Action for Cluster Service Process Error	OS shutdown									<input type="radio"/>
Max Restart Count	3 times					<input type="radio"/>				
Recovery Action over Max Restart Count	No operation					<input type="radio"/>				
Cluster service's not stop normal, prohibit automatic startup	Off						<input type="radio"/>			
Disable recovery action caused by monitor resource error	Off									<input type="radio"/>
<b>Virtual Machine Forced Stop Setting</b>										
Virtual Machine Management Tool	vCenter									<input type="radio"/>
Action	Off									<input type="radio"/>
Timeout	30 seconds									<input type="radio"/>
Command	/usr/lib/vmware-viperl/apps/vm control.pl									<input type="radio"/>
Host Name	-									<input type="radio"/>
User Name	-									<input type="radio"/>
Password	-									<input type="radio"/>
<b>Disable the Final Action when OS Stops Due to Failure Detection</b>										
Group Resource When Activation Failure Detected	Off						<input type="radio"/>			
Group Resource When Deactivation Failure Detected	Off						<input type="radio"/>			
Monitor Resource When Failure Detected	Off						<input type="radio"/>			
<b>Disable Shutdown When Multi-Failover-Service Detected</b>										
Server doesn't Shutdown When Multi-Failover-Service Detected	-						<input type="radio"/>			
<b>Alert Service Tab</b>										
Enable Alert Setting	Off						<input type="radio"/>			
E-mail Address	Blank (Function disabled)									<input type="radio"/>
Subject	EXPRESSCLUSTER									<input type="radio"/>
Mail Method	MAIL									<input type="radio"/>
Use Alert Extension	Off	<input type="radio"/>								
Output the log level to syslog	On						<input type="radio"/>			
Use Chassis Identify	Off									<input type="radio"/>
User Network Warning Light	Off						<input type="radio"/>			
<b>Alert Destination Tab</b>										
Messages (Add, Remove, Edit)	-									<input type="radio"/>
<b>Message Tab</b>										
Category	Core Modules									<input type="radio"/>
Module Type	apisv									<input type="radio"/>
Event ID	-									<input type="radio"/>
Destination System Log	On									<input type="radio"/>
Destination WebManager Alertlog	On									<input type="radio"/>
Destination Mail Report	Off									<input type="radio"/>
Destination SNMP Trap	Off									<input type="radio"/>
Destination Alert Extension	Off									<input type="radio"/>
Command (Add, Remove, Edit)	-									<input type="radio"/>



Parameters	Default	How to change								
		1	2	3	4	5	6	7	8	9
<b>SMTP Settings Tab</b>										
Mail Charset	-									○
Send Mail Timeout	30 seconds									○
Subject Encode	Off									○
SMTP Server (Up, Down)	-									○
SMTP Server List (Add, Remove)	-									○
Enter the SMTP Server										
SMTP Server	-									○
SMTP Port	25									○
Sender Address	-									○
Enable SMTP Authentication	Off									○
Authority Method	LOGIN									○
User Name	-									○
Password	-									○
<b>Behavior Tab</b>										
Destination (Add, Remove, Edit)	-									○
Destination Tab										
Destination Server	-									○
SNMP Port No.	162									○
SNMP Version	v2c									○
SNMP Community Name	public									○
<b>WebManager Tab</b>										
Enable WebManager Service	On									○
Enable WebManager Mobile Connection	Off									○
Accessible number of clients	64									○
Control connection by using client IP address	Off									○
IP Addresses of the Accessible Clients (Add, Remove, Edit)	-									○
Operation	On									○
Web Manager Password										
Password for Operation	-									○
Password for Reference	-									○
Web Manager Mobile Password										
Password for Operation	-									○
Password for Reference	-									○
IP address for Integrated WebManager										
IP address							○			
<b>WebManager Tuning Properties</b>										
Behavior Tab										
Client Session Timeout	30 seconds									○
Max. Number of Alert Records on Viewer	300									○
Reload Interval	90 seconds									○
Mirror Agent Tab	120 seconds									○
Client Data Update Method	Real Time									○
Time Limit For Keeping Log Files	600 seconds									○
Use Time Information Display Function	On						○		○	
<b>Alert Log Tab</b>										
Enable Alert Service	On									○
Max. Number to Save Alert Records	10000									○
Alert Sync Method	Unicast (fixed)									○
Alert Sync Communication Timeout	30 seconds									○
<b>Delay Warning Tab</b>										
Heartbeat Delay Warning	80%						○			
Monitor Delay Warning	80%						○			
<b>Exclusion Tab</b>										

Parameters	Default	How to change								
		1	2	3	4	5	6	7	8	9
Mount/Umount Exclusion	On									0
<b>Mirror Agent Tab <sup>4</sup></b>										
Auto Mirror Recovery	On									0
Collect Mirror Statistics	On		0							
Receive Timeout	10 seconds		0							
Send Timeout	120 seconds									0
Recovery Data Size	4096 kilobytes									0
Recovery Limitation	Off									0
Start Wait Time	10 seconds		0							
Cluster Partition I/O Timeout	30 seconds		0							
<b>Mirror Driver Tab <sup>4</sup></b>										
Max. Number of Request Queues	2048		0							
Bitmap Refresh Interval	100 seconds		0							
Action when an I/O error is detected Cluster Partition	RESET		0							
Action when an I/O error is detected Data Partition	RESET		0							
<b>Power Saving Tab<sup>5</sup></b>										
Use CPU Frequency Control	Off									0
<b>JVM monitor Tab<sup>6</sup></b>										
Java Installation Path	-						0			
Maximum Java Heap Size	7 megabytes						0			
Java VM Additional Option	-						0			
Action Timeout	60 seconds						0			
<b>Log Output Settings</b>										
Log Level	INFO						0			
Generation	10 generations						0			
Rotation Type	File capacity						0			
Rotation Type, File Capacity, Max Size	3072 kilobytes						0			
Rotation Type, Period, Start Time	00:00						0			
Rotation Type, Period, Interval	24 hours						0			
<b>Resource Measurement Settings [Common]</b>										
Retry Count	10 times						0			
Error Threshold	5 times						0			
Interval, Memory Usage, Active Threads	60 seconds						0			
Interval, The time and count in Full GC	120 seconds						0			
<b>Resource Measurement Settings [WebLogic]</b>										
Retry Count	3 times						0			
Error Threshold	5 times						0			
Interval, The number of request	60 seconds						0			
Interval, The average number of the request	300 seconds						0			
<b>Connection Settings</b>										
Management Port	25500						0			
Retry Count	3 times						0			
Waiting time for reconnection	60 seconds						0			
<b>Load Balancer Linkage Settings (for other than BIG-IP)</b>										
Management Port for Load Balancer Linkage	25550						0			
Directory containing HTML files	-						0			

<sup>4</sup> It does not apply to PPC64 and PPC64LE.

<sup>5</sup> It does not apply to PPC64 and PPC64LE.

<sup>6</sup> It does not apply to PPC64 and PPC64LE.

Parameters	Default	How to change								
		1	2	3	4	5	6	7	8	9
HTML File Name	-						0			
HTML Renamed File Name	-						0			
Retry Count for renaming	3 times						0			
Wait time for retry	3 seconds						0			
Load Balancer Linkage Settings (for BIG-IP LTM)										
Management Port for Load Balancer Linkage	25550						0			
mgmt IP address	-						0			
Management User Name	anmin						0			
Password	-						0			
Communication Port Number	443						0			
Server Name	-						0			
IP Address	-						0			
<b>Oracle Clusterware linkage Tab<sup>7</sup></b>										
Use Oracle Clusterware linkage	Off			0						

## Servers

Parameters	Default	How to change								
		1	2	3	4	5	6	7	8	9
<b>Server Common Properties</b>										
<b>Master Server Tab</b>										
Order(Up, Down)	-			0					0	
<b>Server Group Definition</b>										
<b>Server Group Definitions</b>										
Add	The order you added to "Servers that can run the Group."		0							
Remove	-		0							
Rename	-		0							
<b>Server Group Properties</b>										
<b>Info</b>										
Comment										0
<b>Server Group</b>										
Add	-		0							
Remove	-		0							
Order(Up, Down)	The order you added to "Servers that can run the Group."		0							

## Server

Parameters	Default	How to change								
		1	2	3	4	5	6	7	8	9
Add Server <sup>8</sup>	-									
Remove Server <sup>8</sup>	-									
<b>Server Properties</b>										
<b>Info Tab</b>										
Name <sup>9</sup>	-									
Comment	-									0
Virtual machine	Off						0			

<sup>7</sup> It does not apply to PPC64 and PPC64LE.

<sup>8</sup> For details about how to add or remove a server, see Section III on this guide.

<sup>9</sup> Be careful when you change the host name or IP address of a server. For how to change the host name or IP address, see Section III of this guide.

Parameters	Default	How to change								
		1	2	3	4	5	6	7	8	9
Type	vSphere									<input type="radio"/>
Input for Virtual Machine name										
Virtual Machine name										<input type="radio"/>
Data Center										<input type="radio"/>
<b>Warning Light Tab</b>										
I/F No. (Add, Remove)	The order you added I/Fs						<input type="radio"/>			
IP Address (Edit, Up, Down)	-						<input type="radio"/>	<input type="radio"/>		
Warning Light	DN-1000S / DN-1000R / DN-1300GL						<input type="radio"/>			
Alert When Server Starts	Off									<input type="radio"/>
Alert When Server Stops	Off									<input type="radio"/>
Voice File No.	-									<input type="radio"/>
Voice File No.	-									<input type="radio"/>
<b>BMC Tab</b>										
No (Add, Remove)	The order you added						<input type="radio"/>			
IP Address (Edit)	-						<input type="radio"/>			
User Name	-						<input type="radio"/>			
Password	-						<input type="radio"/>			
<b>BMC(High-End Server Option) Tab<sup>10</sup></b>										
No (Add, Remove)	The order you added						<input type="radio"/>			
IP Address (Edit)	-						<input type="radio"/>			
<b>Disk I/O Lockout Tab</b>										
I/F No. (Add, Remove)	The order you added I/Fs						<input type="radio"/>			
Device (Edit, Up, Down)	-	<input type="radio"/>								
<b>PCI Slot Fencing(High-End Server Option) tab<sup>11</sup></b>										
PCI slot 1 to PCI slot 16	Off						<input type="radio"/>			

## Group

Parameters	Default	How to change								
		1	2	3	4	5	6	7	8	9
Add Group	-						<input type="radio"/>			
Remove Group	-				<input type="radio"/>		<input type="radio"/>			
<b>Group Properties</b>										
<b>Info Tab</b>										
Use Server Group Settings(Changes to On)	Off		<input type="radio"/>							
Use Server Group Settings(Changes to Off)	Off		<input type="radio"/>							
Name	failover				<input type="radio"/>		<input type="radio"/>			
Comment	-									<input type="radio"/>
<b>Startup Server Tab(Server)</b>										
Failover is possible on all servers (Changes to On)	On						<input type="radio"/>			
Failover is possible on all servers (Changes to Off)	On						<input type="radio"/>			
Order (Up, Down)	The order you added to "Servers that can run the Group."						<input type="radio"/>			
Name (Add)	-						<input type="radio"/>			
Name(Delete)	-				<input type="radio"/>		<input type="radio"/>			
<b>Startup Server Tab (Server Group)</b>										
Order (Up, Down)	The order you added to "Servers that can run the Group."		<input type="radio"/>							
Name (Add)	-		<input type="radio"/>							

<sup>10</sup> It does not apply to PPC64 and PPC64LE.

<sup>11</sup> It does not apply to PPC64 and PPC64LE.

Parameters	Default	How to change								
		1	2	3	4	5	6	7	8	9
Name(Delete)	-		○							
<b>Attributes Tab</b>										
Startup Attribute	Auto Startup						○			
Failover Attribute	Auto Failover - Use the startup server settings						○			
Perform a Forced Failover	Off						○			
Prioritize failover policy in the server group	Off						○			
Perform a Smart Failover	Off						○			
Enable only manual failover among the server groups	Off						○			
Failback Attribute	Manual Failback						○			
Failover Exclusive Attribute	Off						○			
Dynamic Failover Exclusive List	ip monitor NIC Link Up/Down monitor						○			
<b>Start Dependency Tab</b>										
Dependent Group (Add)	-						○			
Dependent Group (Delete)	-						○			
Target group start wait time	1800 seconds						○			
<b>Property</b>										
Wait Only when on the Same Server	Off						○			
<b>Stop Dependency Tab</b>										
Dependent Group (Add)	-						○			
Dependent Group (Delete)	-						○			
Target group stop wait time	1800 seconds						○			
Wait the Dependent Groups when a Cluster Stops	On									○
Wait the Dependent Groups when a Server Stops	Off									○

## Group Resource (Common)

Parameters	Default	How to change								
		1	2	3	4	5	6	7	8	9
Add Group Resource <sup>12</sup>	-				<input type="radio"/>		<input type="radio"/>			
Remove Group Resource	-					<input type="radio"/>	<input type="radio"/>			
Add Group Resource (Mirror Disk Resource, Hybrid Disk Resource)			<input type="radio"/>							
Remove Group Resource (Mirror Disk Resource, Hybrid Disk Resource)			<input type="radio"/>							
<b>Group Resource Common Properties</b>										
<b>Info Tab</b>										
Name	Each resource default value				<input type="radio"/>		<input type="radio"/>			
Name (Mirror Disk Resource, Hybrid Disk Resource)	Each resource default value		<input type="radio"/>							
Comment	-									<input type="radio"/>
<b>Recovery Operation</b>										
Edit Script										
Select User Application Enter application path (Edit)	-									<input type="radio"/>
Select Script created with this product Script content (Edit)	-									<input type="radio"/>
Timeout	5(sec)									<input type="radio"/>

## Exec resource

Parameters	Default	How to change									
		1	2	3	4	5	6	7	8	9	
<b>Exec Resource Properties</b>											
<b>Dependence Tab</b>											
Follow the default dependence	On <ul style="list-style-type: none"> <li>• floating IP resources</li> <li>• virtual IP resources</li> <li>• disk resources</li> <li>• mirror disk resources</li> <li>• hybrid disk resources</li> <li>• NAS resources</li> <li>• Dynamic DNS resource</li> <li>• Volume manager resource</li> <li>• AWS elastic ip resource</li> <li>• AWS virtual ip resource</li> <li>• Azure probe port resource</li> </ul>							<input type="radio"/>			
Dependent Resources (Add, Remove)	-						<input type="radio"/>				
<b>Recovery Operation Tab</b>											
Retry Count at Activation Failure	zero						<input type="radio"/>				
Maximum Failover Count	1 time						<input type="radio"/>				
Final Action at Activation Failure	No Operation (Not activate next resources)						<input type="radio"/>				
Execute Script before Final Action	Off									<input type="radio"/>	
Retry Count at Deactivation Failure	zero						<input type="radio"/>				
Final Action at Deactivation Failure	Stop the cluster daemon and shut down OS.						<input type="radio"/>				
Execute Script before Final Action	Off									<input type="radio"/>	
<b>Details Tab</b>											
Type (User Application, Script Created with this product)	Script Created with this product									<input type="radio"/>	
User Application	-									<input type="radio"/>	

<sup>12</sup> You can add a resource to support dynamic resource addition without stopping the group. For details, refer to “Adding a resource without stopping the group” in Chapter 10, “The system maintenance information.”

Parameters	Default	How to change								
		1	2	3	4	5	6	7	8	9
Enter the application path (Edit)										
Script Created with this product Script codes (Edit)	-									○
Exec Resource Tuning Properties										
Parameter Tab										
Start Script Synchronous, Asynchronous	Synchronous									○
Start Script Timeout	1800 seconds						○			
Stop Script Synchronous, Asynchronous	Synchronous									○
Stop Script Timeout	1800 seconds						○			
Maintenance Tab										
Log Output Path	Blank (/dev/null)					○				○
Rotate Log	Off					○				
Rotation Size	1000000					○				

## Disk resource

Parameters	Default	How to change								
		1	2	3	4	5	6	7	8	9
<b>Disk Resource Properties</b>										
<b>Dependence Tab</b>										
Follow the default dependence	On <ul style="list-style-type: none"> <li>floating IP resources</li> <li>virtual IP resources</li> <li>Dynamic DNS resource</li> <li>Volume manager resource</li> <li>AWS elastic ip resource</li> <li>AWS virtual ip resource</li> <li>Azure probe port resource</li> </ul>						○			
Dependent Resources (Add, Remove)	-						○			
<b>Recovery Operation Tab</b>										
Retry Count at Activation Failure	zero						○			
Maximum Failover Count	1 time						○			
Final Action at Activation Failure	No Operation (Not activate next resources)						○			
Execute Script before Final Action	Off									○
Retry Count at Deactivation Failure	zero						○			
Final Action at Deactivation Failure	Stop the cluster service and shut down OS.						○			
Execute Script before Final Action	Off									○
<b>Details Tab</b>										
Device Name	-					○				
Raw Device Name	-					○				
Mount Point	-					○				
File System	-									○
Disk Type	disk					○				
Disk Resource Tuning Properties										
<b>Mount Tab</b>										
Mount Option	rw									○
Timeout	60 seconds						○			
Retry Count	3 times						○			
<b>Unmount Tab</b>										
Timeout	120 seconds						○			
Retry Count	3 times						○			
Retry Interval	5 seconds						○			
Forced operation when error is detected	kill									○

Parameters	Default	How to change								
		1	2	3	4	5	6	7	8	9
Fsck Tab (when other than xfs is selected for File System)										
fsck Option	-y									0
fsck Timeout	7200 seconds						0			
fsck action before mount	Execute at Specified Count									0
Count	10 times									0
fsck Action When Mount Failed Execute	On									0
Rebuilding of Reiserfs	Off						0			
xfs_repair Tab (when xfs is selected for File System)										
xfs_repair Option	-									0
xfs_repair Timeout	7200 seconds						0			
xfs_repair Action When Mount Failed Execute	On									0

### Floating IP resource

Parameters	Default	How to change								
		1	2	3	4	5	6	7	8	9
<b>FIP Resource Tuning Properties</b>										
<b>Dependence Tab</b>										
Follow the default dependence	On (No default is set)						0			
Dependent Resources (Add, Remove)	-						0			
<b>Recovery Operation Tab</b>										
Retry Count at Activation Failure	5 times						0			
Maximum Failover Count	1 time						0			
Final Action at Activation Failure	No Operation (Next resources are not activated).						0			
Execute Script before Final Action	Off									0
Retry Count at Deactivation Failure	zero						0			
Final Action at Deactivation Failure	Stop the cluster service and shut down OS.						0			
Execute Script before Final Action	Off									0
<b>Details Tab</b>										
IP Address	-					0				
FIP Resource Tuning Properties										
Parameter Tab										
Ifconfig Timeout	60 seconds						0			
ping Interval	1 second						0			
ping Timeout	1 second						0			
ping Retry Count	zero						0			
ping Forced FIP Activation	Off									0
ARP Send Count	1 time						0			
Judge NIC Link Down as Failure	Off						0			
Deactivity Check Tab										
Confirm I/F Deletion	On									0
Status at Failure	Not Failure									0
Confirm I/F Response	On									0
Status at Failure	Not Failure									0

### Virtual IP resource

Parameters	Default	How to change								
		1	2	3	4	5	6	7	8	9
<b>Virtual IP Resource Properties</b>										
<b>Dependence Tab</b>										
Follow the default dependence	On						0			



Parameters	Default	How to change								
		1	2	3	4	5	6	7	8	9
	(No default dependence)									
Dependent Resources (Add, Remove)	-						○			
<b>Recovery Operation Tab</b>										
Retry Count at Activation Failure	1 time						○			
Maximum Failover Count	1 time						○			
Final Action at Activation Failure	No Operation (Next resources are not activated).						○			
Execute Script before Final Action	Off									○
Retry Count at Deactivation Failure	1 time						○			
Final Action at Deactivation Failure	Stop the cluster service and shut down OS.						○			
Execute Script before Final Action	Off									○
<b>Details Tab</b>										
IP Address	-						○			
NIC Alias Name	-						○			
Destination IP Address	-						○			
Source IP Address	-						○			
Send Interval	10 seconds						○			
User Routing Protocol	-						○			
Virtual IP Resource Tuning Properties										
Parameter Tab										
ifconfig Timeout	60 seconds						○			
Ping Interval	1 second						○			
Ping Timeout	1 second						○			
Ping Retry Count	Zero						○			
Ping Forced VIP Activation	Off									○
ARP Send Count	1 time						○			
Judge NIC Link Down as Failure	Off						○			
Deactivity Check Tab										
Confirm I/F Deletion	On									○
Status at Failure	Not Failure									○
Confirm I/F Response	On									○
Status at Failure	Not Failure									○
RIP Tab										
Next Hop IP Address	-						○			
Metric	1						○			
Port Number	520						○			
RIPng Tab										
Metric	1						○			
Port Number	521						○			

## NAS resource

Parameters	Default	How to change								
		1	2	3	4	5	6	7	8	9
<b>NAS Resource Properties</b>										
<b>Dependence Tab</b>										
Follow the default dependence	On <ul style="list-style-type: none"> <li>floating IP resources</li> <li>virtual IP resources</li> <li>Dynamic DNS resources</li> <li>AWS elastic ip resource</li> <li>AWS virtual ip resource</li> <li>Azure probe port resource</li> </ul>							○		
Dependent Resources (Add, Remove)	-						○			
<b>Recovery Operation Tab</b>										
Retry Count at Activation Failure	zero						○			
Maximum Failover Count	1 time						○			



Parameters	Default	How to change								
		1	2	3	4	5	6	7	8	9
	disk connect I/F tab of the server properties									
Mirror Disk Resource Tuning Properties										
Mount Tab										
Mount Option	rw		○							
Timeout	120 seconds						○			
Retry Count	3 times						○			
Unmount Tab										
Timeout	120 seconds						○			
Retry Count	3 times						○			
Retry Interval	5 seconds						○			
Forced operation when error is detected	kill									○
Fsck Tab (when other than xfs is selected for File System)										
fsck Option	-y									○
fsck Timeout	7200 seconds						○			
fsck action before mount	Execute at Specified Count									○
Count	10 times									○
fsck Action When Mount Failed	Execute									○
Rebuilding of Reiserfs	Off						○			
xfs_repair Tab (when xfs is selected for File System)										
xfs_repair Option	-									○
xfs_repair Timeout	7200 seconds						○			
xfs_repair Action When Mount Failed	On									○
Mirror Tab										
Execute the initial mirror construction	On (valid only for the initial mirror construction)	/	/	/	/	/	/	/	/	/
Execute initial mkfs	On (valid only for the initial mirror construction)	/	/	/	/	/	/	/	/	/
Perform Data Synchronization	On		○							
Mode	Synchronous		○							
Number of Queues	Set Number 2048		○							
Rate limitation of Mirror Connect	Off (Unlimited)		○							
Compress Synchronization Data	Off		○							
Compress Recovery Data	Off		○							
Mirror Driver Tab										
Mirror Data Port Number	29051~		○							
Heartbeat Port Number	29031~		○							
ACK2 Port Number	29071~		○							
Send Timeout	30 seconds		○							
Connection Timeout	10 seconds		○							
Ack Timeout	100 seconds		○							
Receive Timeout	100 seconds		○							
Heartbeat Interval	10 seconds		○							
ICMP Echo Reply Receive Timeout	2 seconds		○							
ICMP Echo Request Retry Count	8 times		○							

## Hybrid disk resource

Parameters	Default	How to change								
		1	2	3	4	5	6	7	8	9

Parameters	Default	How to change								
		1	2	3	4	5	6	7	8	9
<b>Hybrid Disk Resource Properties</b> <sup>14</sup>										
<b>Dependency Tab</b>										
Follow the default dependence	On • floating IP resources • virtual IP resources • AWS elastic ip resource • AWS virtual ip resource • Azure probe port resource						○			
Dependent Resources (Add, Remove)	-						○			
<b>Recovery Operation Tab</b>										
Retry Count at Activation Failure	Zero						○			
Maximum Failover Count	1 time						○			
Final Action at Activation Failure	No Operation (Not activate next resource)						○			
Execute Script before Final Action	Off									○
Retry Count at Deactivation Failure	Zero						○			
Final Action at Deactivation Failure	Stop the cluster service and shutdown OS						○			
Execute Script before Final Action	Off									○
<b>Details Tab</b>										
Mirror Partition Device Name	/dev/NMP1~		○							
Mount Point	-		○							
Data Partition Device Name	-		○							
Cluster Partition Device Name	-		○							
File System	ext3		○							
<b>Selection of Mirror Disk Connect</b>										
<b>Mirror Disk Connect Tab</b>										
I/F No. (Add, Remove, Up, Down)	Top two I/F No. on the mirror disk connect I/F tab of the server properties		○							
<b>Hybrid Disk Resource Tuning Properties</b>										
<b>Mount Tab</b>										
Mount Option	rw		○							
Timeout	120 seconds						○			
Retry Count	3 times						○			
<b>Unmount Tab</b>										
Timeout	120 seconds						○			
Retry Count	3 times						○			
Retry Interval	5 seconds						○			
Forced operation when error is detected	kill									○
<b>Fsck Tab (when other than xfs is selected for File System)</b>										
fsck Option	-y									○
fsck Timeout	7200 seconds						○			
fsck action before mount	Execute at Specified Count									○
Count	10 times									○
fsck Action When Mount Failed	Execute									○
Rebuilding of Reiserfs	Off						○			
<b>xfs_repair Tab (when xfs is selected for File System)</b>										
xfs_repair Option	-									○
xfs_repair Timeout	7200 seconds						○			
xfs_repair Action When Mount Failed	On									○

<sup>14</sup> It does not apply to PPC64 and PPC64LE.

Parameters	Default	How to change								
		1	2	3	4	5	6	7	8	9
<b>Mirror Tab</b>										
Execute the initial mirror construction	On (valid only for the initial mirror construction)									
Perform Data Synchronization	On		○							
Mode	Synchronous		○							
Number of Queues	Set Number 2048		○							
Rate limitation of Mirror Connect	Off (Unlimited)		○							
Compress Synchronization Data	Off		○							
Compress Recovery Data	Off		○							
<b>Mirror Driver Tab</b>										
Mirror Data Port Number	29051~		○							
Heartbeat Port Number	29031~		○							
ACK2 Port Number	29071~		○							
Send Timeout	30 seconds		○							
Connection Timeout	10 seconds		○							
Ack Timeout	100 seconds		○							
Receive Timeout	100 seconds		○							
Heartbeat Interval	10 seconds		○							
ICMP Echo Reply Receive Timeout	2 seconds		○							
ICMP Echo Request Retry Count	8 times		○							

## Volume manager resource

Parameters	Default	How to change								
		1	2	3	4	5	6	7	8	9
<b>Volume Manager Resource Properties</b>										
<b>Dependency Tab</b>										
Follow the default dependence	On •Floating IP resources •Virtual IP resources •Dynamic DNS resources •AWS elastic ip resource •AWS virtual ip resource •Azure probe port resource						○			
Dependent Resources (Add, Remove)	-						○			
<b>Recovery Operation Tab</b>										
Activation Retry Threshold	0 times						○			
Maximum Failover Count	One time						○			
Final Action at Activation Failure	No operation (Do not activate the next resource.)						○			
Execute Script before Final Action	Off									○
Retry Count at Deactivation Failure	0 times						○			
Final Action at Deactivation Failure	Stop the cluster service and shut down the OS.						○			
Execute Script before Final Action	Off									○
<b>Details Tab</b>										
Volume Manager	LVM					○				
Target Name	-					○				
<b>Volume Manager Resource Tuning Properties</b>										
<b>Import Tab</b>										
Import Timeout	300						○			
Start Volume Timeout	60						○			
Volume Status Check Timeout	60						○			
Clear Host ID	On						○			
Force Option at Import	Off						○			
<b>Export Tab</b>										

Parameters	Default	How to change								
		1	2	3	4	5	6	7	8	9
Stop Volume Timeout	60						<input type="radio"/>			
Flush Timeout	60						<input type="radio"/>			
Export Timeout	300						<input type="radio"/>			
Volume Status Check Timeout	60						<input type="radio"/>			

## VM resource

Parameters	Default	How to change								
		1	2	3	4	5	6	7	8	9
<b>VM Resource Properties</b>										
<b>Dependency Tab</b>										
Follow the default dependence	On •disk resource •mirror disk resource •hybrid disk resource •NAS resource •Volume manager resource						<input type="radio"/>			
Dependent Resources (Add, Remove)	-						<input type="radio"/>			
<b>Recovery Operation Tab</b>										
Activation Retry Threshold	0 times						<input type="radio"/>			
Maximum Failover Count	One time						<input type="radio"/>			
Final Action at Activation Failure	No operation (Do not activate the next resource.)						<input type="radio"/>			
Execute Script before Final Action	Off									<input type="radio"/>
Deactivation Retry Threshold	0 times						<input type="radio"/>			
Final Action at Deactivation Failure	Stop the cluster service and shut down the OS.						<input type="radio"/>			
Execute Script before Final Action	Off									<input type="radio"/>
<b>Details Tab (when the virtual machine type is vSphere and the cluster service installation destination is host OS)</b>										
Virtual Machine Name	-					<input type="radio"/>	<input type="radio"/>			
Data Store Name	-						<input type="radio"/>			
VM Path	-				<input type="radio"/>	<input type="radio"/>				
IP Address of Host	-						<input type="radio"/>			
User Name	-						<input type="radio"/>			
Password	-						<input type="radio"/>			
Use vCenter	Off						<input type="radio"/>			
vcenter Host Name	-						<input type="radio"/>			
vcenter User Name	-						<input type="radio"/>			
vcenter Password	-						<input type="radio"/>			
Resource Pool Name	-						<input type="radio"/>			
<b>Details Tab (when the virtual machine type is vSphere and the cluster service installation destination is guest)</b>										
Virtual Machine Name	-					<input type="radio"/>	<input type="radio"/>			
Data Store Name	-						<input type="radio"/>			
IP Address of Host	-						<input type="radio"/>			
User Name	-						<input type="radio"/>			
Password	-						<input type="radio"/>			
Use vCenter	On (uneditable)						<input type="radio"/>			
vCenter	-						<input type="radio"/>			
User Name for vCenter	-						<input type="radio"/>			
Password for vCenter	-						<input type="radio"/>			
Resource Pool Name	-						<input type="radio"/>			
<b>Details Tab (when the virtual machine</b>										

Parameters	Default	How to change								
		1	2	3	4	5	6	7	8	9
<b>type is XenServer)</b>										
Virtual Machine Name	-					○	○			
UUID	-					○	○			
Library Path	-					○	○			
User Name	-						○			○
Password	-						○			○
<b>Details Tab (when the virtual machine type is KVM)</b>										
Virtual Machine Name	-					○	○			
UUID	-					○	○			
Library Path	-					○	○			
VM Resource Tuning Properties										
Parameter Tab										
Request Timeout	30 seconds						○			
Wait Time To Start Virtual Machine	0 seconds						○			
Wait Time To Stop Virtual Machine	240 seconds						○			

## Dynamic DNS resource

Parameters	Default	How to change								
		1	2	3	4	5	6	7	8	9
<b>Dynamic DNS Resource Properties</b>										
<b>Dependency Tab</b>										
Follow the default dependence	On • Floating IP resources • Virtual IP resources • AWS elastic ip resource • AWS virtual ip resource • Azure probe port resource							○		
Dependent Resources (Add, Remove)	-						○			
<b>Recovery Operation Tab</b>										
Activation Retry Threshold	One time						○			
Maximum Failover Count	One time						○			
Final Action at Activation Failure	No operation (Do not activate the next resource.)						○			
Execute Script before Final Action	Off									○
Retry Count at Deactivation Failure	One time						○			
Final Action at Deactivation Failure	Stop the cluster service and shut down the OS						○			
Execute Script before Final Action	Off									○
<b>Details Tab</b>										
Virtual Host Name	-					○				
IP Address	-					○				
DDNS Server	-					○				
Port Number	53					○				
Authentication Key Name	-					○				
Authentication Key Value	-					○				

## AWS elastic ip resource

Parameters	Default	How to change								
		1	2	3	4	5	6	7	8	9
<b>AWS elastic ip Resource Properties</b>										
<b>Dependence Tab</b>										
Follow the default dependence	On (No default dependence)						○			
Dependent Resources (Add, Remove)	-						○			

Recovery Operation Tab											
Retry Count at Activation Failure	5 times									<input type="radio"/>	
Maximum Failover Count	1 time									<input type="radio"/>	
Final Action at Activation Failure	No Operation (Next resources are not activated.)									<input type="radio"/>	
Execute Script before Final Action at Activation Failure	Off										<input type="radio"/>
Retry Count at Deactivation Failure	zero									<input type="radio"/>	
Final Action at Deactivation Failure	Stop the cluster service and shut down OS.									<input type="radio"/>	
Execute Script before Final Action at Deactivation Failure	Off										<input type="radio"/>
Details Tab											
EIP ALLOCATION ID	-									<input type="radio"/>	
ENI ID	-									<input type="radio"/>	
AWS elastic ip Resource Tuning Properties											
Parameter Tab											
AWS CLI Timeout	100 seconds									<input type="radio"/>	

### AWS virtual ip resource

Parameters	Default	How to change									
		1	2	3	4	5	6	7	8	9	
AWS virtual ip Resource Properties											
Dependence Tab											
Follow the default dependence	On (No default dependence)									<input type="radio"/>	
Dependent Resources (Add, Remove)	-									<input type="radio"/>	
Recovery Operation Tab											
Retry Count at Activation Failure	5 times									<input type="radio"/>	
Maximum Failover Count	1 time									<input type="radio"/>	
Final Action at Activation Failure	No Operation (Next resources are not activated.)									<input type="radio"/>	
Execute Script before Final Action at Activation Failure	Off										<input type="radio"/>
Retry Count at Deactivation Failure	zero									<input type="radio"/>	
Final Action at Deactivation Failure	Stop the cluster service and shut down OS.									<input type="radio"/>	
Execute Script before Final Action at Deactivation Failure	Off										<input type="radio"/>
Details Tab											
IP Address	-									<input type="radio"/>	
VPC ID	-									<input type="radio"/>	
ENI ID	-									<input type="radio"/>	
AWS virtual ip Resource Tuning Properties											
Parameter Tab											
AWS CLI Timeout	100 seconds									<input type="radio"/>	

### Azure probe port resource

Parameters	Default	How to change									
		1	2	3	4	5	6	7	8	9	
Azure probe port Resource Properties											





## Monitor resource (common)

Parameters	Default	How to change								
		1	2	3	4	5	6	7	8	9
Add monitor resource	-						<input type="radio"/>			
Remove Monitor Resource	-						<input type="radio"/>			
<b>Monitor Resources Common Properties</b>										
<b>Info Tab</b>										
Name	-						<input type="radio"/>			
Comment	-									<input type="radio"/>
<b>Recovery Action Tab</b>										
Edit Script										
Select User Application Enter application path (Edit)	-									<input type="radio"/>
Select Script created with this product Script content (Edit)	-									<input type="radio"/>
Timeout	5(sec)									<input type="radio"/>

## Disk monitor resource

Parameters	Default	How to change								
		1	2	3	4	5	6	7	8	9
<b>Disk Monitor Resource Properties</b>										
<b>Monitor(common) Tab</b>										
Interval	60 seconds						<input type="radio"/>			
Timeout	120 seconds						<input type="radio"/>			
Collect the dump file of the monitor process at timeout occurrence	Off						<input type="radio"/>			
Do Not Retry at Timeout Occurrence	Off						<input type="radio"/>			
Do not Execute Recovery Action at Timeout Occurrence	Off						<input type="radio"/>			
Retry Count	One time						<input type="radio"/>			
Wait Time to Start Monitoring	0 seconds						<input type="radio"/>			
Monitor Timing	Always						<input type="radio"/>			
Target Resource	-						<input type="radio"/>			
Nice Value	0						<input type="radio"/>			
<b>Error Detection Server</b>										
Error Detection Server	All Servers						<input type="radio"/>			
Servers that can run the Group (Add, Remove)	-						<input type="radio"/>			
<b>Recovery Action Tab</b>										
Recovery Target	-						<input type="radio"/>			
Recovery Script Execution Count	zero						<input type="radio"/>			
Execute Script before Reactivation	Off									<input type="radio"/>
Maximum Reactivation Count	3 times (if the recovery target is other than clusters)						<input type="radio"/>			
Execute Script before Failover	Off									<input type="radio"/>
Execute migration before failing over	Off						<input type="radio"/>			
Maximum Failover Count	1 time (if the recovery target is other than clusters)						<input type="radio"/>			
Execute Script before Final Action	Off									<input type="radio"/>
Final Action	No Operation						<input type="radio"/>			
<b>Monitor(special) Tab</b>										
Method	READ(O_DIRECT)									<input type="radio"/>
Monitor Target	-									<input type="radio"/>
Monitor Target Raw Device Name	-									<input type="radio"/>
I/O size	512 bytes									<input type="radio"/>
Action when diskfull is detected	The recovery action enabled									<input type="radio"/>

## IP monitor resource

Parameters	Default	How to change								
		1	2	3	4	5	6	7	8	9
<b>IP Monitor Resource Properties</b>										
<b>Monitor(common)Tab</b>										
Interval	30 seconds						○			
Timeout	30 seconds						○			
Collect the dump file of the monitor process at timeout occurrence	Off						○			
Do Not Retry at Timeout Occurrence	Off						○			
Do not Execute Recovery Action at Timeout Occurrence	Off						○			
Retry Count	zero						○			
Wait Time to Start Monitoring	0 seconds						○			
Monitor Timing	Always						○			
Target Resource	-						○			
Nice Value	0						○			
<b>Error Detection Server</b>										
Error Detection Server	All Servers						○			
Servers that can run the Group (Add, Remove)	-						○			
<b>Monitor(special) Tab</b>										
IPAddress(Add, Remove, Edit)	-									○
<b>Recovery Action Tab</b>										
Recovery Target	-						○			
Recovery Script Execution Count	zero						○			
Execute Script before Reactivation	Off									○
Maximum Reactivation Count	3 times (if the recovery target is other than clusters)						○			
Execute Script before Failover	Off									○
Execute migration before failing over	Off						○			
Maximum Failover Count	1 time (if the recovery target is other than clusters)						○			
Execute Script before Final Action	Off									○
Final Action	No Operation						○			

## Virtual IP monitor resource

Parameters	Default	How to change								
		1	2	3	4	5	6	7	8	9
<b>Virtual IP Monitor Resource Properties</b> <sup>15</sup>										
<b>Monitor(common)</b>										
Interval	3 seconds						○			
Timeout	30 seconds						○			
Collect the dump file of the monitor process at timeout occurrence	Off						○			
Retry Count	zero						○			
Wait Time to Start Monitoring	0 seconds						○			
Monitor Timing	Active (fixed)						○			
Target Resource	Virtual IP resource name						○			
Nice Value	0						○			
<b>Recovery Action Tab</b>										
Recovery Target	Virtual IP resource name						○			
Recovery Script Execution Count	zero						○			

<sup>15</sup> You can upload the data if a cluster is suspended. However, you need to stop and resume the cluster to apply the changed setting.

Parameters	Default	How to change								
		1	2	3	4	5	6	7	8	9
Execute Script before Reactivation	Off									0
Maximum Reactivation Count	3 times						0			
Execute Script before Failover	Off									0
Execute migration before failing over	Off						0			
Maximum Failover Count	1 time						0			
Execute Script before Final Action	Off									0
Final Action	No Operation						0			

## PID monitor resource

Parameters	Default	How to change								
		1	2	3	4	5	6	7	8	9
<b>Pid Monitor Resource Properties</b>										
<b>Monitor(common)Tab</b>										
Interval	5 seconds						0			
Timeout	60 seconds						0			
Collect the dump file of the monitor process at timeout occurrence	Off						0			
Do Not Retry at Timeout Occurrence	Off						0			
Do not Execute Recovery Action at Timeout Occurrence	Off						0			
Retry Count	zero						0			
Wait Time to Start Monitoring	0 seconds						0			
Monitor Timing	Active (fixed)						0			
Target Resource	-						0			
Nice Value	0						0			
Error Detection Server										
Error Detection Server	All Servers						0			
Servers that can run the Group (Add, Remove)	-						0			
<b>Recovery Action Tab</b>										
Recovery Target	-						0			
Recovery Script Execution Count	zero						0			
Execute Script before Reactivation	Off									0
Maximum Reactivation Count	3 times (if the recovery target is other than clusters)						0			
Execute Script before Failover	Off									0
Execute migration before failing over	Off						0			
Maximum Failover Count	1 time (if the recovery target is other than clusters)						0			
Execute Script before Final Action	Off									0
Final Action	No Operation						0			

## User-mode monitor resource

Parameters	Default	How to change								
		1	2	3	4	5	6	7	8	9
<b>User-mode Monitor Resource Properties</b>										
<b>Monitor(common) Tab</b>										
Interval	3 seconds						0			
Timeout	90 seconds						0			
Wait Time to Start Monitoring	0 seconds						0			
Nice Value	-20						0			
Error Detection Server										
Error Detection Server	All Servers						0			
Servers that can run the Group (Add, Remove)	-						0			

<b>Monitor(special) Tab</b>													
Use heartbeat interval and timeout	On												0
Method	softdog												0
Operation at Timeout Detection	RESET												0
Open/Close Temporary File	Off												0
Write	Off												0
Size	10000 bytes												0
Create Temporary Thread	Off												0

## NIC Link Up/Down monitor resource

Parameters	Default	How to change								
		1	2	3	4	5	6	7	8	9
<b>NIC Link Up/Down Monitor Resource Properties</b>										
<b>Monitor(common) Tab</b>										
Interval	10 seconds									0
Timeout	60 seconds									0
Collect the dump file of the monitor process at timeout occurrence	Off									0
Do Not Retry at Timeout Occurrence	Off									0
Do not Execute Recovery Action at Timeout Occurrence	Off									0
Retry Count	3 times									0
Wait Time to Start Monitoring	0 seconds									0
Monitor Timing	Always									0
Target Resource	-									0
Nice Value	0									0
<b>Error Detection Server</b>										
Error Detection Server	All Servers									0
Servers that can run the Group (Add, Remove)	-									0
<b>Monitor(special) Tab</b>										
Recovery Target	-									0
<b>Recovery Action Tab</b>										
Recovery Target	-									0
Recovery Script Execution Count	zero									0
Execute Script before Reactivation	Off									0
Maximum Reactivation Count	zero									0
Execute Script before Failover	Off									0
Execute migration before failing over	off									0
Maximum Failover Count	1 time (if the recovery target is other than clusters)									0
Execute Script before Final Action	Off									0
Final Action	No Operation									0

## Multi target monitor resource

Parameters	Default	How to change								
		1	2	3	4	5	6	7	8	9
<b>Multi Target Monitor Resource Properties</b>										
<b>Monitor(common) Tab</b>										
Interval	30 seconds									0
Timeout	30 seconds									0
Collect the dump file of the monitor process at timeout occurrence	Off									0
Retry Count	zero									0
Wait Time to Start Monitoring	0 seconds									0
Monitor Timing	Always									0

Parameters	Default	How to change								
		1	2	3	4	5	6	7	8	9
Target Resource	-						○			
Nice Value	0						○			
<b>Monitor(special) Tab</b>										
Recovery Target	-									○
Multi Target Monitor Resource Tuning Properties										
<b>Parameter Tab</b>										
Error Threshold	Same as Number of Members									○
Specify Number	64									○
Warning Threshold	Off									○
Specify Number	-									○
<b>Recovery Action Tab</b>										
Recovery Target	-						○			
Recovery Script Execution Count	zero						○			
Execute Script before Reactivation	Off									○
Maximum Reactivation Count	3 times (if the recovery target is other than clusters)						○			
Execute Script before Failover	Off									○
Execute migration before failing over	Off						○			
Maximum Failover Count	1 time (if the recovery target is other than clusters)						○			
Execute Script before Final Action	Off									○
Final Action	No Operation						○			

### Mirror disk monitor resource

Parameters	Default	How to change								
		1	2	3	4	5	6	7	8	9
<b>Mirror Disk Monitor Resource Properties</b> <sup>16</sup>										
<b>Monitor(common) Tab</b>										
Interval	10 seconds						○			
Timeout	60 seconds						○			
Collect the dump file of the monitor process at timeout occurrence	Off						○			
Do Not Retry at Timeout Occurrence	Off						○			
Do not Execute Recovery Action at Timeout Occurrence	Off						○			
Retry Count	zero						○			
Wait Time to Start Monitoring	0 seconds						○			
Monitor Timing	Always (fixed)						○			
Target Resource	-						○			
Nice Value	0						○			
<b>Monitor(special) Tab</b>										
Mirror Disk Resource	Mirror disk resource name									○
<b>Recovery Action Tab</b>										
Execute Script before Final Action	Off									○

### Mirror disk connect monitor resource

Parameters	Default	How to change								
		1	2	3	4	5	6	7	8	9
<b>Mirror Disk Connect Monitor Resource Properties</b> <sup>17</sup>										

<sup>16</sup> It does not apply to PPC64 and PPC64LE.

<sup>17</sup> It does not apply to PPC64 and PPC64LE.

<b>Monitor(common) Tab</b>										
Interval	60 seconds									○
Timeout	120 seconds									○
Collect the dump file of the monitor process at timeout occurrence	Off									○
Do Not Retry at Timeout Occurrence	Off									○
Do not Execute Recovery Action at Timeout Occurrence	Off									○
Retry Count	zero									○
Wait Time to Start Monitoring	0 seconds									○
Monitor Timing	Always (fixed)									○
Target Resource	-									○
Nice Value	0									○
<b>Monitor(special) Tab</b>										
Mirror Disk Resource	Mirrordisk resource name									○
<b>Recovery Action Tab</b>										
Execute Script before Final Action	Off									○

## Hybrid disk monitor resource

Parameters	Default	How to change								
		1	2	3	4	5	6	7	8	9
<b>Hybrid Disk Monitor Resource Properties</b> <sup>18</sup>										
<b>Monitor(common) Tab</b>										
Interval	10 seconds									○
Timeout	60 seconds									○
Collect the dump file of the monitor process at timeout occurrence	Off									○
Do Not Retry at Timeout Occurrence	Off									○
Do not Execute Recovery Action at Timeout Occurrence	Off									○
Retry Count	zero									○
Wait Time to Start Monitoring	0 seconds									○
Monitor Timing	Always (fixed)									○
Target Resource	-									○
Nice Value	0									○
<b>Monitor(special) Tab</b>										
Hybrid Disk Resource	Hybrid disk resource name									○
<b>Recovery Action Tab</b>										
Execute Script before Final Action	Off									○

## Hybrid disk connect monitor resource

Parameters	Default	How to change								
		1	2	3	4	5	6	7	8	9
<b>Hybrid Disk Connect Monitor Resource Properties</b> <sup>19</sup>										
<b>Monitor(common) Tab</b>										
Interval	60 seconds									○
Timeout	120 seconds									○
Collect the dump file of the monitor process at timeout occurrence	Off									○
Do Not Retry at Timeout Occurrence	Off									○
Do not Execute Recovery Action at Timeout Occurrence	Off									○

<sup>18</sup> It does not apply to PPC64 and PPC64LE.

<sup>19</sup> It does not apply to PPC64 and PPC64LE.











Parameters	Default	How to change								
		1	2	3	4	5	6	7	8	9
Timeout Occurrence										
Retry Count	zero						0			
Wait Time to Start Monitoring	0 seconds						0			
Monitor Timing	Always						0			
Target Resource	-						0			
Nice value	0						0			
<b>Error Detection Server</b>										
Error Detection Server	All servers						0			
Servers that can run the Group (Add, Remove)	-						0			
<b>Monitor(special) Tab</b>										
Process name	-						0			
Minimum Monitored Process Count	1						0			
<b>Recovery Action tab</b>										
Recovery Target	-						0			
Recovery Script Execution Count	zero						0			
Execute Script before Reactivation	Off									0
Maximum Reactivation Count	3 times						0			
Execute Script before Failover	Off									0
Execute migration before failing over	Off						0			
Maximum Failover Count	1 time (When the recovery target is other than the cluster)						0			
Execute Script before Final Action	Off									0
Final Action	No Operation						0			

## BMC monitor resource<sup>20</sup>

Parameters	Default	How to change								
		1	2	3	4	5	6	7	8	9
<b>BMC Monitor Resource Properties</b>										
<b>Monitor (common) Tab</b>										
Interval	5 seconds						0			
Timeout	60 seconds						0			
Collect the dump file of the monitor process at timeout occurrence	Off						0			
Retry Count	zero						0			
Wait Time to Start Monitoring	0 seconds						0			
Monitor Timing	Always						0			
Target Resource	-						0			
Nice Value	0						0			
<b>Error Detection Server</b>										
Error Detection Server	All servers						0			
Servers that can run the Group (Add, Remove)	-						0			
<b>Recovery Action Tab</b>										
Recovery Action	Final action only						0			
Recovery Target	LocalServer						0			
Recovery Script Execution Count	-						0			
Execute Script before Reactivation	-									0
Maximum Reactivation Count	-						0			
Execute Script before Failover	-									0
Execute migration before failing over	-						0			
Maximum Failover Count	-						0			
Execute Script before Final Action	Off									0
Final Action	I/O fencing						0			

<sup>20</sup> It does not apply to PPC64 and PPC64LE.

## DB2 monitor resource

Parameters	Default	How to change								
		1	2	3	4	5	6	7	8	9
<b>DB2 Monitor Resource Properties</b>										
<b>Monitor(common) Tab</b>										
Interval	60 seconds						○			
Timeout	120 seconds						○			
Collect the dump file of the monitor process at timeout occurrence	Off						○			
Do Not Retry at Timeout Occurrence	Off						○			
Do not Execute Recovery Action at Timeout Occurrence	Off						○			
Retry Count	2 times						○			
Wait Time to Start Monitoring	0 seconds						○			
Monitor Timing	Active (fixed)						○			
Target Resource	-						○			
Nice Value	0						○			
<b>Error Detection Server</b>										
Error Detection Server	All servers						○			
Servers that can run the Group (Add, Remove)	-						○			
<b>Monitor(special) Tab</b>										
Monitor Level	Level 2 (monitoring by update/select)						○			
Database Name	-						○			
Instance	db2inst1						○			
User Name	db2inst1						○			
Password	ibmdb2						○			
Table	db2watch						○			
Character Set	ja_JP.eucJP						○			
Library Path	/opt/IBM/db2/V8.2/lib/libdb2.so						○			
<b>Recovery Action Tab</b>										
Recovery Target	-						○			
Recovery Script Execution Count	zero						○			
Execute Script before Reactivation	Off									○
Maximum Reactivation Count	Zero (if the recovery target is other than clusters)						○			
Execute Script before Failover	Off									○
Execute migration before failing over	Off						○			
Maximum Failover Count	1 time (if the recovery target is other than clusters)						○			
Execute Script before Final Action	Off									○
Final Action	Stop cluster daemon and shutdown OS						○			

## FTP monitor resource

Parameters	Default	How to change								
		1	2	3	4	5	6	7	8	9
<b>FTP Monitor Resource Properties</b>										
<b>Monitor(common) Tab</b>										
Interval	60 seconds						○			
Timeout	120 seconds						○			
Collect the dump file of the monitor process at timeout occurrence	Off						○			
Do Not Retry at Timeout Occurrence	Off						○			
Do not Execute Recovery Action at Timeout Occurrence	Off						○			

Parameters	Default	How to change								
		1	2	3	4	5	6	7	8	9
Retry Count	3 times						<input type="radio"/>			
Wait Time to Start Monitoring	0 seconds						<input type="radio"/>			
Monitor Timing	Active						<input type="radio"/>			
Target Resource	-						<input type="radio"/>			
Nice Value	0						<input type="radio"/>			
Error Detection Server										
Error Detection Server	All servers						<input type="radio"/>			
Servers that can run the Group (Add, Remove)							<input type="radio"/>			
<b>Monitor(special) Tab</b>										
IP Address	127.0.0.1									<input type="radio"/>
Port Number	21									<input type="radio"/>
User Name	-									<input type="radio"/>
Password	-									<input type="radio"/>
<b>Recovery Action Tab</b>										
Recovery Target	-						<input type="radio"/>			
Recovery Script Execution Count	zero						<input type="radio"/>			
Execute Script before Reactivation	Off									<input type="radio"/>
Maximum Reactivation Count	Zero (if the recovery target is other than clusters)						<input type="radio"/>			
Execute Script before Failover	Off									<input type="radio"/>
Execute migration before failing over	Off						<input type="radio"/>			
Maximum Failover Count	1 time (if the recovery target is other than clusters)						<input type="radio"/>			
Execute Script before Final Action	Off									<input type="radio"/>
Final Action	Stop cluster service and shutdown OS						<input type="radio"/>			

## HTTP monitor resource

Parameters	Default	How to change								
		1	2	3	4	5	6	7	8	9
<b>HTTP Monitor Resource Properties</b>										
<b>Monitor(common) Tab</b>										
Interval	60 seconds						<input type="radio"/>			
Timeout	10 seconds						<input type="radio"/>			
Collect the dump file of the monitor process at timeout occurrence	Off						<input type="radio"/>			
Do Not Retry at Timeout Occurrence	Off						<input type="radio"/>			
Do not Execute Recovery Action at Timeout Occurrence	Off						<input type="radio"/>			
Retry Count	3 times						<input type="radio"/>			
Wait Time to Start Monitoring	0 seconds						<input type="radio"/>			
Monitor Timing	Active						<input type="radio"/>			
Target Resource	-						<input type="radio"/>			
Nice Value	0						<input type="radio"/>			
Error Detection Server										
Error Detection Server	All servers						<input type="radio"/>			
Servers that can run the Group (Add, Remove)							<input type="radio"/>			
<b>Monitor(special) Tab</b>										
Connecting Destination	localhost									<input type="radio"/>
Port Number	80									<input type="radio"/>
Request URI	-									<input type="radio"/>
Protocol	HTTP									<input type="radio"/>
<b>Recovery Action Tab</b>										
Recovery Target	-						<input type="radio"/>			
Recovery Script Execution Count	zero						<input type="radio"/>			

Parameters	Default	How to change								
		1	2	3	4	5	6	7	8	9
Execute Script before Reactivation	Off									0
Maximum Reactivation Count	Zero (if the recovery target is other than clusters)						0			
Execute Script before Failover	Off									0
Execute migration before failing over	Off						0			
Maximum Failover Count	1 time (if the recovery target is other than clusters)						0			
Execute Script before Final Action	Off									0
Final Action	Stop cluster service and shutdown OS						0			

## IMAP4 monitor resource

Parameters	Default	How to change								
		1	2	3	4	5	6	7	8	9
<b>IMAP4 Monitor Resource Properties</b>										
<b>Monitor(common) Tab</b>										
Interval	60 seconds						0			
Timeout	120 seconds						0			
Collect the dump file of the monitor process at timeout occurrence	Off						0			
Do Not Retry at Timeout Occurrence	Off						0			
Do not Execute Recovery Action at Timeout Occurrence	Off						0			
Retry Count	3 times						0			
Wait Time to Start Monitoring	0 seconds						0			
Monitor Timing	Active (fixed)						0			
Target Resource	-						0			
Nice Value	0						0			
Error Detection Server										
Error Detection Server	All servers						0			
Servers that can run the Group (Add, Remove)	-						0			
<b>Monitor(special) Tab</b>										
IP Address	127.0.0.1									0
Port	3306									0
User Name	-									0
Password	-									0
Authority Method	AUTHENTICATE LOGIN									0
<b>Recovery Action Tab</b>										
Recovery Target	-						0			
Recovery Script Execution Count	zero						0			
Execute Script before Reactivation	Off									0
Maximum Reactivation Count	Zero (if the recovery target is other than clusters)						0			
Execute Script before Failover	Off									0
Execute migration before failing over	Off						0			
Maximum Failover Count	1 time (if the recovery target is other than clusters)						0			
Execute Script before Final Action	Off									0
Final Action	Stop cluster service and shutdown OS						0			

## MySQL monitor resource

Parameters	Default	How to change								
		1	2	3	4	5	6	7	8	9

Parameters	Default	How to change								
		1	2	3	4	5	6	7	8	9
<b>MySQL Monitor Resource Properties</b>										
<b>Monitor(common) Tab</b>										
Interval	60 seconds						0			
Timeout	120 seconds						0			
Collect the dump file of the monitor process at timeout occurrence	Off						0			
Do Not Retry at Timeout Occurrence	Off						0			
Do not Execute Recovery Action at Timeout Occurrence	Off						0			
Retry Count	2 times						0			
Wait Time to Start Monitoring	0 seconds						0			
Monitor Timing	Active (fixed)						0			
Target Resource	-						0			
Nice Value	0						0			
<b>Error Detection Server</b>										
Error Detection Server	All servers						0			
Servers that can run the Group (Add, Remove)	-						0			
<b>Monitor(special) Tab</b>										
Monitor Level	Level 2 (monitoring by update/select)						0			
Database Name	-						0			
IP Address	127.0.0.1						0			
Port	3306						0			
User Name	-						0			
Password	-						0			
Table	mysqlwatch						0			
Storage Engine	MyISAM						0			
Library Path	/usr/lib/mysql/libmysqlclient.so.15						0			
<b>Recovery Action Tab</b>										
Recovery Target	-						0			
Recovery Script Execution Count	zero						0			
Execute Script before Reactivation	Off									0
Maximum Reactivation Count	Zero (if the recovery target is other than clusters)						0			
Execute Script before Failover	Off									0
Execute migration before failing over	Off						0			
Maximum Failover Count	1 time (if the recovery target is other than clusters)						0			
Execute Script before Final Action	Off									0
Final Action	Stop cluster service and shutdown OS						0			

## NFS monitor resource

Parameters	Default	How to change								
		1	2	3	4	5	6	7	8	9
<b>Nfs Monitor Resource Properties</b>										
<b>Monitor(common) Tab</b>										
Interval	30 seconds						0			
Timeout	60 seconds						0			
Collect the dump file of the monitor process at timeout occurrence	Off						0			
Do Not Retry at Timeout Occurrence	Off						0			
Do not Execute Recovery Action at Timeout Occurrence	Off						0			
Retry Count	5 times						0			



Parameters	Default	How to change								
		1	2	3	4	5	6	7	8	9
Wait Time to Start Monitoring	0 seconds						○			
Monitor Timing	Active						○			
Target Resource	-						○			
Nice Value	0						○			
Error Detection Server										
Error Detection Server	All servers						○			
Servers that can run the Group (Add, Remove)							○			
<b>Monitor(special) Tab</b>										
Share Directory	-									○
IP Address	127.0.0.1									○
NFS Version	v2									○
<b>Recovery Action Tab</b>										
Recovery Target	-						○			
Recovery Script Execution Count	zero						○			
Execute Script before Reactivation	Off									○
Maximum Reactivation Count	Zero (if the recovery target is other than clusters)						○			
Execute Script before Failover	Off									○
Execute migration before failing over	Off						○			
Maximum Failover Count	1 time (if the recovery target is other than clusters)						○			
Execute Script before Final Action	Off									○
Final Action	Stop cluster service and shutdown OS						○			

## Oracle monitor resource

Parameters	Default	How to change								
		1	2	3	4	5	6	7	8	9
<b>Oracle Monitor Resource Properties</b>										
<b>Monitor(common) Tab</b>										
Interval	60 seconds						○			
Timeout	120 seconds						○			
Collect the dump file of the monitor process at timeout occurrence	Off						○			
Do Not Retry at Timeout Occurrence	Off						○			
Do not Execute Recovery Action at Timeout Occurrence	Off						○			
Retry Count	2 times						○			
Wait Time to Start Monitoring	0 seconds						○			
Monitor Timing	Active (fixed)						○			
Target Resource	-						○			
Nice Value	0						○			
Error Detection Server										
Error Detection Server	All servers						○			
Servers that can run the Group (Add, Remove)							○			
<b>Monitor(special) Tab</b>										
Monitor Method	listener and instance monitor						○			
Monitor Level	Level 2 (monitoring by update/select)						○			
Connect Command	-						○			
User Name	sys						○			
Password	change_on_install						○			
Authority	SYSDBA						○			
Table	orawatch						○			
ORACLE_HOME	-						○			

Parameters	Default	How to change								
		1	2	3	4	5	6	7	8	9
Character Set	JAPANESE_JAPAN.JA16EUC						<input type="radio"/>			
Library Path	/opt/app/oracle/product/10.2.0/db_1/lib/libclntsh.so.10.1						<input type="radio"/>			
Collect Details at the Time of Error	disabled						<input type="radio"/>			
Collection Timeout	600 seconds						<input type="radio"/>			
Set error during Oracle initialization or shutdown	disabled						<input type="radio"/>			
<b>Recovery Action Tab</b>										
Recovery Target	-						<input type="radio"/>			
Recovery Script Execution Count	zero						<input type="radio"/>			
Execute Script before Reactivation	Off									<input type="radio"/>
Maximum Reactivation Count	Zero (if the recovery target is other than clusters)						<input type="radio"/>			
Execute Script before Failover	Off									<input type="radio"/>
Execute migration before failing over	Off						<input type="radio"/>			
Maximum Failover Count	1 time (if the recovery target is other than clusters)						<input type="radio"/>			
Execute Script before Final Action	Off									<input type="radio"/>
Final Action	Stop cluster service and shutdown OS						<input type="radio"/>			

## OracleAS monitor resource

Parameters	Default	How to change								
		1	2	3	4	5	6	7	8	9
<b>OracleAS Monitor Resource Properties</b>										
<b>Monitor(common) Tab</b>										
Interval	60 seconds						<input type="radio"/>			
Timeout	120 seconds						<input type="radio"/>			
Collect the dump file of the monitor process at timeout occurrence	Off						<input type="radio"/>			
Do Not Retry at Timeout Occurrence	Off						<input type="radio"/>			
Do not Execute Recovery Action at Timeout Occurrence	Off						<input type="radio"/>			
Retry Count	1 times						<input type="radio"/>			
Wait Time to Start Monitoring	0 seconds						<input type="radio"/>			
Monitor Timing	Active (fixed)						<input type="radio"/>			
Target Resource	-						<input type="radio"/>			
Nice Value	0						<input type="radio"/>			
<b>Monitor(special) Tab</b>										
Error Detection Server										
Error Detection Server	All servers						<input type="radio"/>			
Servers that can run the Group (Add, Remove)	-						<input type="radio"/>			
Instance Name	-									<input type="radio"/>
Install Path	/home/ias/product/10.1.3.2/companionCDHome_1									<input type="radio"/>
Monitor Type	Monitor component only									<input type="radio"/>
Component Monitor	All						<input type="radio"/>			
Component List	-									<input type="radio"/>
<b>Recovery Action Tab</b>										
Recovery Target	-						<input type="radio"/>			
Recovery Script Execution Count	zero						<input type="radio"/>			
Execute Script before Reactivation	Off									<input type="radio"/>
Maximum Reactivation Count	Zero (if the recovery target is other than clusters)						<input type="radio"/>			
Execute Script before Failover	Off									<input type="radio"/>



Parameters	Default	How to change								
		1	2	3	4	5	6	7	8	9
Retry Count	3 times						<input type="radio"/>			
Wait Time to Start Monitoring	0 seconds						<input type="radio"/>			
Monitor Timing	Active (fixed)						<input type="radio"/>			
Target Resource	-						<input type="radio"/>			
Nice Value	0						<input type="radio"/>			
Error Detection Server										
Error Detection Server	All servers						<input type="radio"/>			
Servers that can run the Group (Add, Remove)	-						<input type="radio"/>			
<b>Monitor(special) Tab</b>										
IP Address	127.0.0.1									<input type="radio"/>
Port	110									<input type="radio"/>
User Name	-									<input type="radio"/>
Password	-									<input type="radio"/>
Authority Method	APOP									<input type="radio"/>
<b>Monitor(special) Tab</b>										
Recovery Target	-						<input type="radio"/>			
Recovery Script Execution Count	zero						<input type="radio"/>			
Execute Script before Reactivation	Off									<input type="radio"/>
Maximum Reactivation Count	Zero (if the recovery target is other than clusters)						<input type="radio"/>			
Execute Script before Failover	Off									<input type="radio"/>
Execute migration before failing over	Off						<input type="radio"/>			
Maximum Failover Count	1 time (if the recovery target is other than clusters)						<input type="radio"/>			
Execute Script before Final Action	Off									<input type="radio"/>
Final Action	Stop cluster service and shutdown OS						<input type="radio"/>			

## PostgreSQL monitor resource

Parameters	Default	How to change								
		1	2	3	4	5	6	7	8	9
<b>PostgreSQL Monitor Resource Properties</b>										
<b>Monitor(common) Tab</b>										
Interval	60 seconds						<input type="radio"/>			
Timeout	120 seconds						<input type="radio"/>			
Collect the dump file of the monitor process at timeout occurrence	Off						<input type="radio"/>			
Do Not Retry at Timeout Occurrence	Off						<input type="radio"/>			
Do not Execute Recovery Action at Timeout Occurrence	Off						<input type="radio"/>			
Retry Count	2 times						<input type="radio"/>			
Wait Time to Start Monitoring	0 seconds						<input type="radio"/>			
Monitor Timing	Active (fixed)						<input type="radio"/>			
Target Resource	-						<input type="radio"/>			
Nice Value	0						<input type="radio"/>			
Error Detection Server										
Error Detection Server	All servers						<input type="radio"/>			
Servers that can run the Group (Add, Remove)	-						<input type="radio"/>			
<b>Monitor(special) Tab</b>										
Monitor Level	Level 2 (monitoring by update/select)						<input type="radio"/>			
Database Name	-						<input type="radio"/>			
IP Address	127.0.0.1						<input type="radio"/>			
Port	5432						<input type="radio"/>			

Parameters	Default	How to change								
		1	2	3	4	5	6	7	8	9
User Name	postgres						○			
Password	-						○			
Table	psqlwatch						○			
Library Path	/usr/lib/libpq.so.3.0						○			
Set error during PostgreSQL initialization or shutdown	On						○			
<b>Recovery Action Tab</b>										
Recovery Target	-						○			
Recovery Script Execution Count	zero						○			
Execute Script before Reactivation	Off									○
Maximum Reactivation Count	Zero (if the recovery target is other than clusters)						○			
Execute Script before Failover	Off									○
Execute migration before failing over	Off						○			
Maximum Failover Count	1 time (if the recovery target is other than clusters)						○			
Execute Script before Final Action	Off									○
Final Action	Stop cluster service and shutdown OS						○			

## Samba monitor resource

Parameters	Default	How to change								
		1	2	3	4	5	6	7	8	9
<b>Samba Monitor Resource Properties</b>										
<b>Monitor(common) Tab</b>										
Interval	30 seconds						○			
Timeout	60 seconds						○			
Collect the dump file of the monitor process at timeout occurrence	Off						○			
Do Not Retry at Timeout Occurrence	Off						○			
Do not Execute Recovery Action at Timeout Occurrence	Off						○			
Retry Count	5 times						○			
Wait Time to Start Monitoring	0 seconds						○			
Monitor Timing	Active						○			
Target Resource	-						○			
Nice Value	0						○			
<b>Monitor(special) Tab</b>										
Share Name	-									○
IP Address	127.0.0.1									○
Port	139									○
User Name	-									○
Password	-									○
<b>Recovery Action Tab</b>										
Recovery Target	-						○			
Recovery Script Execution Count	zero						○			
Execute Script before Reactivation	Off									○
Maximum Reactivation Count	Zero (if the recovery target is other than clusters)						○			
Execute Script before Failover	Off									○
Execute migration before failing over	Off						○			
Maximum Failover Count	1 time (if the recovery target is other than clusters)						○			

Parameters	Default	How to change								
		1	2	3	4	5	6	7	8	9
Execute Script before Final Action	Off									0
Final Action	Stop cluster service and shutdown OS						0			

## SMTP monitor resource

Parameters	Default	How to change								
		1	2	3	4	5	6	7	8	9
<b>SMTP Monitor Resource Properties</b>										
<b>Monitor(common) Tab</b>										
Interval	60 seconds						0			
Timeout	120 seconds						0			
Collect the dump file of the monitor process at timeout occurrence	Off						0			
Do Not Retry at Timeout Occurrence	Off						0			
Do not Execute Recovery Action at Timeout Occurrence	Off						0			
Retry Count	3 times						0			
Wait Time to Start Monitoring	0 seconds						0			
Monitor Timing	Active						0			
Target Resource	-						0			
Nice Value	0						0			
<b>Monitor(special) Tab</b>										
IP Address	127.0.0.1									0
Port	25									0
<b>Recovery Action Tab</b>										
Recovery Target	-						0			
Recovery Script Execution Count	zero						0			
Execute Script before Reactivation	Off									0
Maximum Reactivation Count	Zero (if the recovery target is other than clusters)						0			
Execute Script before Failover	Off									0
Execute migration before failing over	Off						0			
Maximum Failover Count	1 time (if the recovery target is other than clusters)						0			
Execute Script before Final Action	Off									0
Final Action	Stop cluster service and shutdown OS						0			

## Sybase monitor resource

Parameters	Default	How to change								
		1	2	3	4	5	6	7	8	9
<b>Sybase Monitor Resource Properties</b>										
<b>Monitor(common) Tab</b>										
Interval	60 seconds						0			
Timeout	120 seconds						0			
Collect the dump file of the monitor process at timeout occurrence	Off						0			
Do Not Retry at Timeout Occurrence	Off						0			
Do not Execute Recovery Action at Timeout Occurrence	Off						0			
Retry Count	2 times						0			
Wait Time to Start Monitoring	0 seconds						0			

Parameters	Default	How to change								
		1	2	3	4	5	6	7	8	9
Monitor Timing	Active (fixed)						○			
Target Resource	-						○			
Nice Value	0						○			
Error Detection Server										
Error Detection Server	All servers						○			
Servers that can run the Group (Add, Remove)							○			
<b>Monitor(special) Tab</b>										
Monitor Level	Level 2 (monitoring by update/select)						○			
Database Name	-						○			
Database Server Name	-						○			
User Name	sa						○			
Password	-						○			
Table	sybwatch						○			
Library Path	/opt/sybase/OCS-12_5/lib/libsybdb.so						○			
<b>Recovery Action Tab</b>										
Recovery Target	-						○			
Recovery Script Execution Count	zero						○			
Execute Script before Reactivation	Off									○
Maximum Reactivation Count	Zero (if the recovery target is other than clusters)						○			
Execute Script before Failover	Off									○
Execute migration before failing over	Off						○			
Maximum Failover Count	1 time (if the recovery target is other than clusters)						○			
Execute Script before Final Action	Off									○
Final Action	Stop cluster service and shutdown OS						○			

## Tuxedo monitor resource

Parameters	Default	How to change								
		1	2	3	4	5	6	7	8	9
<b>Tuxedo Monitor Resource Properties</b>										
<b>Monitor(common) Tab</b>										
Interval	60 seconds						○			
Timeout	120 seconds						○			
Collect the dump file of the monitor process at timeout occurrence	Off						○			
Do Not Retry at Timeout Occurrence	Off						○			
Do not Execute Recovery Action at Timeout Occurrence	Off						○			
Retry Count	2 times						○			
Wait Time to Start Monitoring	0 seconds						○			
Monitor Timing	Active (fixed)						○			
Target Resource	-						○			
Nice Value	0						○			
Error Detection Server										
Error Detection Server	All servers						○			
Servers that can run the Group (Add, Remove)							○			
<b>Monitor(special) Tab</b>										
Application Server Name	BBL									○
Config File	-									○
Library Path	/opt/BEA/tuxedo8.1/lib/libtux.so									○
<b>Recovery Action Tab</b>										

Parameters	Default	How to change								
		1	2	3	4	5	6	7	8	9
Recovery Target	-						0			
Recovery Script Execution Count	zero						0			
Execute Script before Reactivation	Off									0
Maximum Reactivation Count	Zero (if the recovery target is other than clusters)						0			
Execute Script before Failover	Off									0
Execute migration before failing over	Off						0			
Maximum Failover Count	1 time (if the recovery target is other than clusters)						0			
Execute Script before Final Action	Off									0
Final Action	Stop cluster service and shutdown OS						0			

### Weblogic monitor resource

Parameters	Default	How to change								
		1	2	3	4	5	6	7	8	9
<b>Weblogic Monitor Resource Properties</b>										
<b>Monitor(common) Tab</b>										
Interval	60 seconds						0			
Timeout	120 seconds						0			
Collect the dump file of the monitor process at timeout occurrence	Off						0			
Do Not Retry at Timeout Occurrence	Off						0			
Do not Execute Recovery Action at Timeout Occurrence	Off						0			
Retry Count	2 times						0			
Wait Time to Start Monitoring	0 seconds						0			
Monitor Timing	Active (fixed)						0			
Target Resource	-						0			
Nice Value	0						0			
Error Detection Server										
Error Detection Server	All servers						0			
Servers that can run the Group (Add, Remove)							0			
<b>Monitor(special) Tab</b>										
IP Address	127.0.0.1									0
Port	7002									0
Account Shadow	Off									0
On Config File	-									0
On Key File	-									0
Off User Name	weblogic									0
Off Password	weblogic									0
Authority Method	DemoTrust									0
Key Store File	-									0
Domain Environment File	/opt/bean/weblogic81/samples/do mains/examples/setExamplesEnv.sh									0
Additional Command Option	-Dwlst.offline.log=disable -Duser.language=en_US									0
<b>Recovery Action Tab</b>										
Recovery Target	-						0			
Recovery Script Execution Count	zero						0			
Execute Script before Reactivation	Off									0
Maximum Reactivation Count	Zero (if the recovery target is other than clusters)						0			
Execute Script before Failover	Off									0





Parameters	Default	How to change								
		1	2	3	4	5	6	7	8	9
Do Not Retry at Timeout Occurrence	Off						<input type="radio"/>			
Do not Execute Recovery Action at Timeout Occurrence	Off						<input type="radio"/>			
Retry Count	1 time						<input type="radio"/>			
Wait Time to Start Monitoring	0 seconds						<input type="radio"/>			
Monitor Timing	Active (fixed)						<input type="radio"/>			
Target Resource	-						<input type="radio"/>			
Nice Value	0						<input type="radio"/>			
Error Detection Server										
Error Detection Server	All servers						<input type="radio"/>			
Servers that can run the Group (Add, Remove)							<input type="radio"/>			
<b>Monitor(special) Tab</b>										
Connecting Destination	localhost									<input type="radio"/>
Port	6212									<input type="radio"/>
User Name	-									<input type="radio"/>
Password	-									<input type="radio"/>
Install Path	/opt/WebOTX									<input type="radio"/>
<b>Recovery Action Tab</b>										
Recovery Target	-						<input type="radio"/>			
Recovery Script Execution Count	zero						<input type="radio"/>			
Execute Script before Reactivation	Off									<input type="radio"/>
Maximum Reactivation Count	Zero (if the recovery target is other than clusters)						<input type="radio"/>			
Execute Script before Failover	Off									<input type="radio"/>
Execute migration before failing over	Off						<input type="radio"/>			
Maximum Failover Count	1 time (if the recovery target is other than clusters)						<input type="radio"/>			
Execute Script before Final Action	Off									<input type="radio"/>
Final Action	Stop cluster service and shutdown OS						<input type="radio"/>			

## JVM monitor resource

Parameters	Default	How to change								
		1	2	3	4	5	6	7	8	9
<b>JVM Monitor Resource Properties</b>										
<b>Monitor(common) Tab</b>										
Interval	60 seconds						<input type="radio"/>			
Timeout	120 seconds						<input type="radio"/>			
Collect the dump files of the monitor process at timeout occurrence	Off						<input type="radio"/>			
Retry Count	zero						<input type="radio"/>			
Wait Time to Start Monitoring	0 seconds						<input type="radio"/>			
Monitor Timing	Active						<input type="radio"/>			
Target Resource	-						<input type="radio"/>			
Nice Value	0						<input type="radio"/>			
Error Detection Server										
Error Detection Server	All servers						<input type="radio"/>			
Servers that can run the Group (Add, Remove)	-						<input type="radio"/>			
<b>Monitor(special) Tab</b>										
Target	-						<input type="radio"/>			
JVM Type	-						<input type="radio"/>			
Identifier	-						<input type="radio"/>			
Connection Port	-						<input type="radio"/>			
Process Name	-						<input type="radio"/>			
User	-						<input type="radio"/>			

Parameters	Default	How to change								
		1	2	3	4	5	6	7	8	9
Password	-						0			
Command	-						0			
Memory Tab (when Oracle Java is selected for JVM Type)										
Monitor Heap Memory Rate	On						0			
Total Usage	80[%]						0			
Eden Space	100[%]						0			
Survivor Space	100[%]						0			
Tenured Gen	80[%]						0			
Monitor Non-Heap Memory Rate	On						0			
Total Usage	80[%]						0			
Code Cache	100[%]						0			
Perm Gen	80[%]						0			
Perm Gen[shared-ro]	80[%]						0			
Perm Gen[shared-rw]	80[%]						0			
Monitor Virtual Memory Usage	2048 megabytes						0			
Command	-						0			
Memory Tab (when Oracle JRockit is selected for JVM Type)										
Monitor Heap Memory Rate	On						0			
Total Usage	80[%]						0			
Nursery Space	80[%]						0			
Old Space	80[%]						0			
Monitor Non-Heap Memory Rate	On						0			
Total Usage	80[%]						0			
Class Memory	100[%]						0			
Monitor Virtual Memory Usage	2048 megabytes						0			
Command	-						0			
Memory Tab(when Oracle Java(usage monitoring) is selected for JVM Type)										
Monitor Heap Memory Usage	Off						0			
Total Usage	0 megabytes						0			
Eden Space	0 megabytes						0			
Survivor Space	0 megabytes						0			
Tenured Gen(Old Gen)	0 megabytes						0			
Monitor Non-Heap Memory Usage	Off						0			
Total Usage	0 megabytes						0			
Code Cache	0 megabytes						0			
Metaspace	0 megabytes						0			
Monitor Virtual Memory Usage	2048 megabytes						0			
Command	-						0			
Thread Tab										
Monitor the number of Active Threads	65535 threads						0			
Command	-						0			
GC Tab										
Monitor the time in Full GC	65535 milliseconds						0			
Monitor the count of Full GC execution	1 time						0			
Command	-						0			
WebLogic Tab										
Monitor the requests in Work Manager	Off						0			
Target Work Managers	-						0			
The number	65535						0			
Average	65535						0			
Increment from the last	80[%]						0			
Monitor the requests in Thread Pool	On						0			
Waiting Requests, The number	65535						0			
Waiting Requests, Average	65535						0			

Parameters	Default	How to change								
		1	2	3	4	5	6	7	8	9
Waiting Requests, Increment from the last	80[%]						<input type="radio"/>			
Executing Requests, The number	65535						<input type="radio"/>			
Executing Requests, Average	65535						<input type="radio"/>			
Executing Requests, Increment from the last	80[%]						<input type="radio"/>			
Command	-						<input type="radio"/>			
Load Balancer Linkage										
Memory Pool Monitor	Off						<input type="radio"/>			
Disconnect Failure Node Dynamically	Off						<input type="radio"/>			
Reboot Command	-						<input type="radio"/>			
Timeout	3600						<input type="radio"/>			
<b>Recovery Action Tab</b>										
Recovery Target	-						<input type="radio"/>			
Recovery Script Execution Count	zero						<input type="radio"/>			
Execute Script before Reactivation	Off									<input type="radio"/>
Maximum Reactivation Count	0 time (when the recovery target is other than the cluster)						<input type="radio"/>			
Execute Script before Failover	Off									<input type="radio"/>
Execute migration before failing over	Off						<input type="radio"/>			
Maximum Failover Count	1 time (when the recovery target is other than the cluster)						<input type="radio"/>			
Execute Script before Final Action	Off									<input type="radio"/>
Final Action	No Operation						<input type="radio"/>			

## System Monitor Resource

Parameters	Default	How to change								
		1	2	3	4	5	6	7	8	9
<b>System Monitor Resource Properties</b>										
<b>Monitor(common) Tab</b>										
Interval	30 seconds						<input type="radio"/>			
Timeout	60 seconds						<input type="radio"/>			
Collect the dump file of the monitor process at timeout occurrence	Off						<input type="radio"/>			
Retry Count	zero						<input type="radio"/>			
Wait Time to Start Monitoring	0 seconds						<input type="radio"/>			
Monitor Timing	Always						<input type="radio"/>			
Target Resource	-						<input type="radio"/>			
Nice Value	0						<input type="radio"/>			
<b>Monitor(special) Tab</b>										
SystemResourceAgent system Settings										
Monitoring CPU usage	ON						<input type="radio"/>			
CPU usage	90[%]						<input type="radio"/>			
Duration time	60 minutes						<input type="radio"/>			
Monitoring total usage of memory	ON						<input type="radio"/>			
Total usage of memory	90[%]						<input type="radio"/>			
Duration time	60 minutes						<input type="radio"/>			
Monitoring total usage of virtual memory	ON						<input type="radio"/>			
Total usage of virtual memory	90[%]						<input type="radio"/>			

Parameters	Default	How to change								
		1	2	3	4	5	6	7	8	9
Duration Time	60 minutes						○			
Monitoring total number of opening files	ON						○			
Total number of opening files (in a ratio comparing with the system upper limit)	90[%]						○			
Duration time	60 minutes						○			
Monitoring total number of running threads	ON						○			
Total number of running threads	90[%]						○			
Duration time	60 minutes						○			
Monitoring number of running processes for each user	ON						○			
Number of running processes for each user	90[%]						○			
Duration time	60 minutes						○			
<b>System Resource Agent Process Settings</b>										
CPU utilization has been 90% or more for 24 hours or more	ON						○			
Memory usage has increased, including an increase of 10% or more from the first monitoring point after 24 hours or more has passed	ON						○			
The maximum number of open files has been updated over 1000 times	ON						○			
The number of open files exceeds 90% or more of the kernel limit	ON						○			
The number of running threads has been increasing for over 24 hours	ON						○			
The process has been in a zombie state for over 24 hours	ON						○			
100 or more processes of the same name exist	OFF						○			
<b>System Resource Agent Disk Settings</b>										
Mount point							○			
Utilization rate	ON						○			
Warning level	90%						○			
Notice level	80 %						○			
Duration time	1440 minutes						○			
Free space	ON						○			
Warning level	500 MB						○			
Notice level	1000 MB						○			
Duration time	1440 minutes						○			
<b>Recovery Action Tab</b>										
Recovery Target	-						○			
Recovery Script Execution Count	zero						○			
Execute Script before Reactivation	Off									○
Maximum Reactivation Count	0 times (when the recovery target is other than the cluster)						○			
Execute Script before Failover	Off									○
Execute migration before failing over	Off						○			
Maximum Failover Count	0 times (when the recovery target is other than the cluster)						○			
Execute Script before Final Action	Off									○
Final Action	No Operation						○			

## Floating IP monitor resources

Parameter	Default	How to change								
		1	2	3	4	5	6	7	8	9
<b>Floating IP Monitor Resource Properties</b>										
<b>Monitor(common) Tab</b>										
Interval	60 seconds						<input type="radio"/>			
Timeout	60 seconds						<input type="radio"/>			
Collect the dump files of the monitor process at timeout occurrence	Off						<input type="radio"/>			
Do Not Retry at Timeout Occurrence	Off						<input type="radio"/>			
Do not Execute Recovery Action at Timeout Occurrence	Off						<input type="radio"/>			
Retry count	1 time						<input type="radio"/>			
Wait Time to Start Monitoring	0 seconds						<input type="radio"/>			
Monitor Timing	Active (fixed)						<input type="radio"/>			
Target Resource	-						<input type="radio"/>			
Nice Value	0						<input type="radio"/>			
<b>Error Detection Server</b>										
Error Detection Server	All servers						<input type="radio"/>			
Servers that can run the Group (Add, Remove)	-						<input type="radio"/>			
<b>Monitor(special) Tab</b>										
Monitor NIC Link Up/Down	Off									<input type="radio"/>
<b>Recovery Action Tab</b>										
Recovery Target	-						<input type="radio"/>			
Recovery Script Execution Count	0 times						<input type="radio"/>			
Execute Script before Reactivation	Off									<input type="radio"/>
Maximum Reactivation Count	3 times (when the recovery target is other than the cluster)						<input type="radio"/>			
Execute Script before Failover	Off									<input type="radio"/>
Execute migration before failing over	Off						<input type="radio"/>			
Maximum Failover Count	1 time (when the recovery target is other than the cluster)						<input type="radio"/>			
Execute Script before Final Action	Off									<input type="radio"/>
Final Action	No operation						<input type="radio"/>			

## AWS elastic ip monitor resource

Parameters	Default	How to change								
		1	2	3	4	5	6	7	8	9
<b>AWS elastic ip Monitor Resource Properties</b>										
<b>Monitor(common) Tab</b>										
Interval	60 seconds						<input type="radio"/>			
Timeout	100 seconds						<input type="radio"/>			
Collect the dump file of the monitor process at timeout occurrence	Off						<input type="radio"/>			
Do Not Retry at Timeout Occurrence	Off						<input type="radio"/>			
Do not Execute Recovery Action at Timeout Occurrence	Off						<input type="radio"/>			
Retry Count	1 time						<input type="radio"/>			
Wait Time to Start Monitoring	0 seconds						<input type="radio"/>			
Monitor Timing	Active (fixed)						<input type="radio"/>			
Target Resource	awseip						<input type="radio"/>			
Nice Value	0						<input type="radio"/>			



Parameters	Default	How to change								
		1	2	3	4	5	6	7	8	9
<b>AWS AZ Monitor Resource Properties</b>										
<b>Monitor(common)Tab</b>										
Interval	60 seconds						<input type="radio"/>			
Timeout	100 seconds						<input type="radio"/>			
Collect the dump file of the monitor process at timeout occurrence	Off						<input type="radio"/>			
Do Not Retry at Timeout Occurrence	Off						<input type="radio"/>			
Do not Execute Recovery Action at Timeout Occurrence	Off						<input type="radio"/>			
Retry Count	1 time						<input type="radio"/>			
Wait Time to Start Monitoring	0 seconds						<input type="radio"/>			
Monitor Timing	Always (fixed)						<input type="radio"/>			
Target Resource	-						<input type="radio"/>			
Nice Value	0						<input type="radio"/>			
Error Detection Server										
Error Detection Server	All Servers						<input type="radio"/>			
Servers that can run the group (Add, Remove)	-						<input type="radio"/>			
<b>Monitor(special) Tab</b>										
Availability Zone	-						<input type="radio"/>			
Action when AWS CLI command failed to receive response	Disable recovery action(Display warning)						<input type="radio"/>			
<b>Recovery Action Tab</b>										
Recovery Target	-						<input type="radio"/>			
Recovery Script Execution Count	zero						<input type="radio"/>			
Execute Script before Reactivation	Off									<input type="radio"/>
Maximum Reactivation Count	0 times (if the recovery target is other than clusters)						<input type="radio"/>			
Execute Script before Failover	Off									<input type="radio"/>
Execute migration before failing over	Off						<input type="radio"/>			
Maximum Failover Count	1 time (if the recovery target is other than clusters)						<input type="radio"/>			
Execute Script before Final Action	Off									<input type="radio"/>
Final Action	No Operation						<input type="radio"/>			

### Azure probe port monitor resource

Parameters	Default	How to change								
		1	2	3	4	5	6	7	8	9
<b>Azureprobe port Monitor Resource Properties</b>										
<b>Monitor (common) Tab</b>										
Interval	60 seconds						<input type="radio"/>			
Timeout	100 seconds						<input type="radio"/>			
Collect the dump file of the monitor process at timeout occurrence	Off						<input type="radio"/>			
Do Not Retry at Timeout Occurrence	Off						<input type="radio"/>			
Do not Execute Recovery Action at Timeout Occurrence	Off						<input type="radio"/>			
Retry Count	1 time						<input type="radio"/>			
Wait Time to Start Monitoring	0 seconds						<input type="radio"/>			
Monitor Timing	Active (fixed)						<input type="radio"/>			
Target Resource	azurepp						<input type="radio"/>			
Nice Value	0						<input type="radio"/>			
Error Detection Server										
Error Detection Server	All Servers						<input type="radio"/>			





## Upper limits of registration

	Builder version	You can register up to
Cluster	3.0.0-1 or later	1
Server	3.0.0-1 or later	32
Server group	3.0.0-1 or later	9
Group	3.1.0-1 or later	128
Group resource (Per group)	3.1.0-1 or later	256
Monitor resource	3.0.0-1 or later	512
Heartbeat resource	3.0.0-1 or later	128
BMC Heartbeat resource	3.1.0-1 or later	1
Oracle Clusterware Synchronization Management monitor resource	3.2.0-1 or later	1
Network partition resolution resource	3.0.0-1 or later	64
Mirror disk resources and hybrid disk resources (Per cluster) in total	3.0.0-1 or later	8
Mirror disk connect	3.0.0-1 or later	16
System monitor resource	3.1.0-1 or later	1

# Chapter 3 EXPRESSCLUSTER command reference

This chapter describes commands that are used on EXPRESSCLUSTER.

This chapter covers:

- Operating the cluster from the command line.....296
- EXPRESSCLUSTER commands .....297
- Displaying the cluster status (clpstat command) .....299
- Operating the cluster (clpcl command).....395
- Shutting down a specified server (clpdown command).....399
- Shutting down the entire cluster (clpstdn command) .....400
- Operating groups (clpgrp command).....401
- Collecting logs (clplogcc command) .....408
- Changing, backing up, and checking cluster configuration data (clpcfctrl command).....417
- Adjusting time-out temporarily (clptoratio command).....438
- Modifying the log level and size (clplogcf command) .....441
- Managing licenses (clplensc command) .....451
- Locking disk I/O (clproset command) .....456
- Mirror-related commands .....458
- Displaying the mirror status (clpmdstat command).....458
- Operating mirror disk resource (clpmdctrl command) .....470
- Initializing mirror disks (clpmdinit command).....485
- Hybrid-disk-related commands .....489
- Displaying the hybrid disk status (clphdstat command) .....489
- Operating hybrid disk resource (clphdctrl command) .....500
- Initializing hybrid disks (clphdinit command).....516
- Outputting messages (clplogcmd command).....520
- Controlling monitor resources (clpmonctrl command).....523
- Controlling group resources (clprsc command).....531
- Controlling reboot count (clpregctrl command) .....536
- Turning off warning light (clplamp command) .....539
- Controlling CPU frequency (clpcpufreq command).....540
- Controlling chassis identify lamp (clpledctrl command).....542
- Processing inter-cluster linkage (clptrnreq command) .....544
- Requesting processing to cluster servers (clprexec command) .....546
- Changing BMC information (clpbmccnf command).....550
- Controlling cluster activation synchronization wait processing (clpbwctrl command).....552
- Estimating the amount of resource usage (clpprer command).....553
- Checking the process health (clphealthchk command).....558

## Operating the cluster from the command line

EXPRESSCLUSTER provides various commands to operate a cluster by the command line. These commands are useful for things like constructing a cluster or when you cannot use the WebManager. You can perform greater number of operations using the command line than WebManager.

---

**Note:**

When you have configured a group resource (examples: disk resource and exec resource) as a recovery target in the settings of error detection by a monitor resource, and the monitor resource detects an error, do not perform the following actions by commands related to the actions or by the WebManager while recovery (reactivation -> failover -> final action) is ongoing.

- ◆ terminate/suspend the cluster
- ◆ start/terminate/migrate a group

If you perform the actions mentioned above against the cluster while the recovery caused by detection of an error by a monitor resource is ongoing, other group resources of that group may not terminate. However, you can perform these actions as long as the final action has been executed, even if a monitor resource detected an error.

---

**Important:**

The installation directory contains executable-format files and script files that are not listed in this guide. Do not execute these files by programs or applications other than EXPRESSCLUSTER. Any problems caused by not using EXPRESSCLUSTER will not be supported.

---

## EXPRESSCLUSTER commands

Commands for configuring a cluster		
Command	Description	Page
clpcfctrl	Distributes configuration data created by the Builder to servers. Backs up the cluster configuration data to be used by the Builder.	417
clplcncs	Registers and refers to the product or test version license of this product.	451

Commands for displaying status		
Command	Description	Page
clpstat	Displays the cluster status and configuration information.	299
clphealthchk	Check the process health.	558

Commands for cluster operation		
Command	Description	Page
clpcl	Starts, stops, suspends, or resumes the EXPRESSCLUSTER daemon.	395
clpdown	Stops the EXPRESSCLUSTER daemon and shuts down the server.	399
clpstdn	Stops the EXPRESSCLUSTER daemon across the whole cluster and shuts down all servers.	400
clpgrp	Starts, stops, or moves groups. This command also migrates the virtual machine.	401
clptoratio	Extends or displays the various time-out values of all servers in the cluster.	438
clproset	Modifies and displays I/O permission of a shared disk partition device.	456
clpmonctrl	Controls monitor resources.	523
clpregctrl	Displays or initializes the reboot count on a single server.	536
clprsc	Stops or resumes group resources	531
clpcpufreq	Controls CPU frequency.	540
clpledctrl	Controls the chassis identify function.	542
clptrnreq	Requests a server to execute a process.	544
clprexec	Requests that an EXPRESSCLUSTER server execute a process from external monitoring.	544
clpbmccnf	Changes the information on BMC user name and password.	550
clpbwctrl	Controls the cluster activation synchronization wait processing.	552

<b>Log-related commands</b>		
<b>Command</b>	<b>Description</b>	<b>Page</b>
clplogcc	Collects logs and OS information.	408
clplogcf	Modifies and displays a configuration of log level and the file size of log output.	441

<b>Script-related commands</b>		
<b>Command</b>	<b>Description</b>	<b>Page</b>
clplogcmd	Writes texts in the exec resource script to create a desired message to the output destination	520

<b>Mirror-related commands (when the Replicator is used)</b>		
<b>Command</b>	<b>Description</b>	<b>Page</b>
clpmdstat	Displays a mirroring status and configuration information.	458
clpmdctrl	Activates/deactivates a mirror disk resource, or recovers mirror. Displays or modifies the maximum number of the request queues.	500
clpmdinit	Initializes the cluster partition of a mirror disk resource. Creates a file system on the data partition of a mirror disk resource.	516

<b>Hybrid disk-related commands (when the Replicator DR is used)</b>		
<b>Command</b>	<b>Description</b>	<b>Page</b>
clphdstat	Displays the hybrid disk status and configuration information.	489
clphdctrl	Activates/deactivates a hybrid disk resource, or recovers mirror. Displays or modifies the maximum number of the request queues.	500
clphdinit	Initializes the cluster partition of a hybrid disk resource.	483

<b>System monitor-related commands (when the System Resource Agent is used)</b>		
<b>Command</b>	<b>Description</b>	<b>Page</b>
clpprer	Estimates the future value from the tendency of the given resource use amount data.	520

<b>Other commands</b>		
<b>Command</b>	<b>Description</b>	<b>Page</b>
clplamp	Lights off the warning light of the specified server.	539

## Displaying the cluster status (clpstat command)

**clpstat:** the `clpstat` command displays cluster status and configuration information.

**Command line:**

```
clpstat -s [--long] [-h hostname]
clpstat -g [-h hostname]
clpstat -m [-h hostname]
clpstat -n [-h hostname]
clpstat -p [-h hostname]
clpstat -i [--detail] [-h hostname]
clpstat --cl [--detail] [-h hostname]
clpstat --sv [server_name] [--detail] [-h hostname]
clpstat --hb [hb_name] [--detail] [-h hostname]
clpstat --np [np_name] [--detail] [-h hostname]
clpstat --svg [servergroup_name] [--detail]
    [-h hostname]
clpstat --grp [group_name] [--detail] [-h hostname]
clpstat --rsc [resource_name] [--detail] [-h hostname]
clpstat --mon [monitor_name] [--detail] [-h hostname]
clpstat --local
```

**Description**      This command line displays a cluster status and configuration data.

<b>Option</b>		
-s or No option		Displays a cluster status.
--long		Displays a name of the cluster name and resource name until the end.
-g		Displays a cluster group map.
-m		Displays status of each monitor resource on each server.
-n		Displays each heartbeat resource status on each server.
-p		Displays the status of network partition resolution resource on each server.
-i		Displays the configuration information of the whole cluster.
--cl		Displays the cluster configuration data. Displays the Mirror Agent information as well for the Replicator, Replicator DR.
--sv [ <i>server_name</i> ]		Displays the server configuration information. By specifying the name of a server, you can display information of the specified server.
--hb [ <i>hb_name</i> ]		Displays heartbeat resource configuration information. By specifying the name of a heartbeat resource, you can display only the information on the specified heartbeat.

<code>--np [np_name]</code>	Displays network partition resolution resource configuration information. By specifying the name of a network partition resolution resource, you can display only the information on the specified network partition resolution resource.
<code>--svg [servergroup_name]</code>	Displays server group configuration information. By specifying the name of a server group, you can display only the information on the specified server group.
<code>--rsc [resource_name]</code>	Displays group resource configuration information. By specifying the name of a group resource, you can display only the information on the specified group resource.
<code>--mon [monitor_name]</code>	Displays monitor resource configuration information. By specifying the name of a monitor resource, you can display only the information on the specified resource.
<code>--detail</code>	Displays more detailed information on the setting.
<code>-h hostname</code>	Acquires information from the server specified with <i>hostname</i> . Acquires information from the command running server (local server) when the <code>-h</code> option is omitted.
<code>--local</code>	Displays the cluster status. This option displays the same information when <code>-s</code> option is specified or when no option is specified. However, this option displays only information of the server on which this command is executed, without communicating with other servers.

When the `-s` option is not specified

<b>Return Value</b>	0	Success
	9	The command was run duplicatedly.
	Other than the above	Failure
<b>Remarks</b>	According to the combination of options, configuration information shows information in various forms.	
<b>Notes</b>	Run this command as the root user.  The cluster daemon must be activated on the server where you run this command.  When you specify the name of a server for the <code>-h</code> option, the server should be in the cluster.  For the language used for command output, see “Cluster properties Info tab” in Chapter 2 “Functions of the Builder” in this guide.  When you run the <code>clpstat</code> command with the <code>-s</code> option or without any option, names such as a cluster or a resource will not be displayed halfway.	



**Example of Execution**

Examples of information displayed after running these commands are provided in the next section.

**Error Messages**

<b>Message</b>	<b>Cause/Solution</b>
Log in as root.	Log on as the root user.
Invalid configuration file. Create valid cluster configuration data by using the Builder.	Create valid cluster configuration data by using the Builder.
Invalid option.	Specify a valid option.
Could not connect to the server. Check if the cluster daemon is active.	Check if the cluster daemon is activated.
Invalid server status.	Check if the cluster daemon is activated.
Server is not active. Check if the cluster daemon is active.	Check if the cluster daemon is activated.
Invalid server name. Specify a valid server name in the cluster.	Specify the valid name of a server in the cluster.
Invalid heartbeat resource name. Specify a valid heartbeat resource name in the cluster.	Specify the valid name of a heartbeat resource in the cluster.
Invalid network partition resource name. Specify a valid network partition resource name in the cluster.	Specify the valid name of a network partition resolution resource in the cluster.
Invalid group name. Specify a valid group name in the cluster.	Specify the valid name of a group in the cluster.
Invalid group resource name. Specify a valid group resource name in the cluster.	Specify the valid name of a group resource in the cluster.
Invalid monitor resource name. Specify a valid monitor resource name in the cluster.	Specify the valid name of a monitor resource in the cluster.
Connection was lost. Check if there is a server where the cluster daemon is stopped in the cluster.	Check if there is any server on which the cluster daemon has stopped in the cluster.
Invalid parameter.	The value specified as a command parameter may be invalid.
Internal communication timeout has occurred in the cluster server. If it occurs frequently, set a longer timeout.	A time-out occurred in the EXPRESSCLUSTER internal communication. If time-out keeps occurring, set the internal communication time-out longer.
Internal error. Check if memory or OS resources are sufficient.	Check to see if the memory or OS resource is sufficient.
Invalid server group name. Specify a valid server group name in the cluster.	Specify the correct server group name in the cluster.
The cluster is not created.	Create and apply the cluster configuration data.

## Common entry examples

### Displaying the status of the cluster (-s option)

The following is an example of display when you run the clpstat command with the -s option or without any option:

#### Example of a command entry

```
# clpstat -s
```

#### Example of the display after running the command

```
===== CLUSTER STATUS =====
Cluster : cluster                                -> See (1)
<server>
 *server1 .....: Online                server1          -> See (2)
   lanhb1       : Normal                LAN Heartbeat   -> See (3)
   lanhb2       : Normal                LAN Heartbeat   -> See (3)
   diskhb1      : Normal                Disk Heartbeat  -> See (3)
   comhb1       : Normal                COM Heartbeat   -> See (3)
   pingnp1      : Normal                ping resolution -> See (4)
   pingnp2      : Normal                ping resolution -> See (4)

server2 .....: Online                server2
   lanhb1       : Normal                LAN Heartbeat
   lanhb2       : Normal                LAN Heartbeat
   diskhb1      : Normal                Disk Heartbeat
   comhb1       : Normal                COM Heartbeat
   pingnp1      : Normal                ping resolution
   pingnp2      : Normal                ping resolution
<group>
 failover1 .....: Online                failover group1 ->See (5)
   current      : server1
   disk1        : Online                /dev/sdb5       ->See (6)
   execl        : Online                exec resource1
   fip1         : Online                10.0.0.11
   failover2 .....: Online                failover group2
   current      : server2
   disk2        : Online                /dev/sdb6
   exec2        : Online                exec resource2
   fip2         : Online                10.0.0.12
<monitor> ->See (8)
 diskw1        : Normal                disk monitor1   ->See (7)
 diskw2        : Normal                disk monitor2
 ipw1          : Normal                ip monitor1
 pidw1         : Normal                pidw1
 userw         : Normal                usermode monitor
 sraw          : Normal                sra monitor
=====
```

#### Explanation of each item

- (1) Cluster : Cluster name
- (2) Server name : Status Server comment  
“\*” indicates the server has executed this command.
- (3) Heartbeat resource name : Status Heartbeat resource comment

- (4) Network partition resolution resource name  
: Status Network partition resolution resource comment
- (5) Group name : Status Group comment  
Current : Status Server name  
Shows the server to which the group belongs now.
- (6) Group Resource Name : Status Group resource comment
- (7) Monitor Resource Name : Status Monitor resource comment  
If dummy failure occurred in the monitor resource, “(Dummy Failure)” is added after the status.
- (8) The following descriptions are displayed after the monitor resource name.
- If the monitor resource contains an error and the recovery action is restricted, "Recovery Action Disabled" is displayed.
  - If dummy failure occurred in the monitor resource, “Failure Verification” is displayed.
- Information on each status is provided in “Status Descriptions” on page 392.

## Displaying a group map (-g option)

To display a group map, run the `clpstat` command with the `-g` option.

### Example of a command entry

```
# clpstat -g
```

### Example of the display after running the command:

```
===== GROUPMAP INFORMATION =====
Cluster : cluster                -> See (1)
*server0 : server1              -> See (2)
server1 : server2

-----
server0 [o] : failover1[o] failover2[o] -> See (3)
server1 [o] : failover3[o]
=====
```

### Explanation of each item

- (1) Cluster: Cluster name
- (2) server n: Server name (n is the index number of a server)  
“\*” indicates the server has executed this command.
- (3) server n [*server\_status*]: Group Name [*status*] Group Name [*status*] ...  
Displays the status of groups in the n-th server.
- In the example above, the groups failover1 and failover2 exist on server0, and the group failover 3 exists on server 3.
- ◆ Groups that are not running are not displayed.
  - ◆ Information on each status is provided in “Status Descriptions” on page 392.

## Displaying the status of monitor resources (-m option)

To display the status of monitor resources, run the `clpstat` command with the `-m` option.

### Example of a command entry

```
# clpstat -m
```

### Example of the display after running the command:

```
===== MONITOR RESOURCE STATUS =====
Cluster : cluster                -> see (1)
*server0 : server1              -> see (2)
server1  : server2              -> see (2)
Monitor0 [diskw1 : Normal]     -> see (3)
-----
server0 [o] : Online            -> see (4)
server1 [o] : Online            -> see (4)
Monitor1 [diskw2 : Normal]
-----
server0 [o] : Online
server1 [o] : Online
Monitor2 [ipw1 : Normal]
-----
server0 [o] : Online
server1 [o] : Online
Monitor3 [pidw1 : Normal]
-----
server0 [o] : Online
server1 [o] : Offline
Monitor4 [userw : Normal]
-----
server0 [o] : Online
server1 [o] : Online
Monitor5 [sraw : Normal]
-----
server0 [o] : Online
server1 [o] : Online
=====
```

### Explanation of each item

- (1) Cluster: Cluster name
- (2) server n: Server name (n is the index number of a server)  
“\*” indicates the server has executed this command.
- (3) Monitor n [*monitor\_resource\_name: status*]  
(n is the identification number of a monitor resource)  
The status of a monitor resource gathering status information per server is displayed here.  
If dummy failure occurred in the monitor resource, “(Dummy Failure)” is displayed after the monitor status.
- (4) server n [*server\_status*]: status  
Displays the status of each monitor resource per server.  
If dummy failure occurred in the monitor resource, “(Dummy Failure)” is displayed after the server status.

Information on each status is provided in “Status Descriptions” on page 392.

## Displaying the status of heartbeat resources (-n option)

To display the status of heartbeat resources, run `clpstat` command with the `-n` option.

### Example of a command entry

```
# clpstat -n
```

### Example of the display after running the command:

```
===== HEARTBEAT RESOURCE STATUS =====
Cluster : cluster          -> see (1)
*server0 : server1        -> see (2)
  server1 : server2        -> see (2)
  HB0 : lanhb1            -> see (3)
  HB1 : lanhb2            -> see (3)
  HB2 : diskhb1           -> see (3)
  HB3 : comhb1            -> see (3)

  [on server0 : Online] -> see (4)
    HB   0  1  2  3 -> see (5)
-----
server0:  o  o  o  o      -> see (5)
server1:  o  o  o  x      -> see (5)

  [on server1 : Online]
    HB   0  1  2  3
-----
server0 :  o  o  o  x
server1 :  o  o  o  o
=====
```

### Explanation of each item

- (1) Cluster: Cluster name
- (2) server n: Server name (n is the index number of a server)  
“\*” indicates the server has executed this command.
- (3) HB n: Heartbeat resource name  
(n is the identification number of a heartbeat resource)
- (4) [on server n : *status*]: Displays the status of the server whose index number is n.
- (5) HB 0 1 2 ..., server n : *status status status*  
Displays the status of heartbeat resource on the server.  
The numbers following HB are heartbeat resource identification numbers described in (3).

Detailed information on each status is provided in “Status Descriptions” on page 392.

### The status of the example shown above:

The example above presents the status of all heartbeat resources seen from server0 and server1 when the COM heartbeat resource is disconnected.

Because comhb1, a COM heartbeat resource, is not able to communicate from both servers, communication to server1 on server0 or communication to server0 on server1 is unavailable.

The rest of heartbeat resources on both servers are in the status allowing communications.

## Displaying the status of network partition resolution resources (-p option)

To display the status of network partition resolution resources, run `clpstat` command with the `-p` option.

### Example of a command entry

```
# clpstat -p
```

### Example of the display after running the command:

```
===== NETWORK PARTITION RESOURCE STATUS =====
Cluster : cluster          -> see (1)
*server0 : server1        -> see (2)
  server1 : server2        -> see (2)
  NP0 : pingnp1           -> see (3)
  NP1 : pingnp2           -> see (3)

      [on server0 : Caution] -> see (4)
      NP      0  1 -> see (5)
-----
server0 : o  x   -> see (5)
server1 : o  o   -> see (5)

      [on server1 : Caution]
      NP      0  1
-----
server0 : o  x
server1 : o  x
=====
```

### Explanation of each item

- (1) Cluster: Cluster name
- (2) server n: Server name (n is the index number of a server)  
“\*” indicates the server has executed this command.
- (3) NP n: Network partition resolution resource name  
(n is the identification number of network partition resolution resource)
- (4) [on server n : *status*]: Displays the status of the server whose index number is n.
- (5) NP 0 1 ..., server n : *status status status*:  
Displays the status of network partition resolution resource on the server.  
The numbers following NP are network partition resolution resource identification numbers described in 3.

Detailed information on each status is provided in “Status Descriptions” on page 392.

### The status of the example shown above:

The example above presents the status of all the network partition resolution resources seen from server0 and server1 when the device to which ping of the network partition resolution resource pingnp2 is sent is down.

## Displaying the cluster configuration data (--c1 option)

To display the configuration data of a cluster, run the `clpstat` command with the `-i`, `--c1`, `--svg`, `--hb`, `--grp`, `--rsc`, or `--mon` option. You can see more detailed information by specifying the `--detail` option.

For details of each item of the list, see “Parameter list Cluster” in Chapter 2 “Functions of the Builder” in this guide.

To display the cluster configuration data, run the `clpstat` command with the `--c1` option.

### Example of a command entry

```
# clpstat --c1 --detail
```

### Example of the display after running the command:

```
===== CLUSTER INFORMATION =====
[Cluster : cluster]                                -> see (1)
  Comment: failover cluster                        -> see (2)
<Heartbeat I/F>
  Server Down Notification      : On               -> see (3)
<NP Resolution>
  Action at NP Occurrence      : Stop the cluster service
                               and shutdown OS     -> see (4)
<Timeout>
  Server Sync Wait Time (sec)   : 300            -> see (5)
  Heartbeat Timeout (msec)     : 90000         -> see (6)
  Heartbeat Interval (msec)    : 3000          -> see (7)
  Server Internal Timeout (sec) : 180          -> see (8)
  Timeout Ratio                : 1              -> see (9)
<Port No.>
  Server Internal Port Number   : 29001       -> see (10)
  Data Transfer Port Number    : 29002       -> see (11)
  Heartbeat Port Number        : 29002       -> see (12)
  Kernel Mode Heartbeat Port Number: 29006     -> see (13)
  WebManager HTTP Port Number  : 29003       -> see (14)
  Alert Sync Port Number       : 29003       -> see (15)
<Port No.(Mirror)>
  Mirror Agent Port Number     : 29004       -> see (16)
<Port No.(Log)>
  Communication Method for Internal Logs
                               : UNIX Domain    -> see (17)
  Port Number                  : 0             -> see (18)
<Monitor>
  Shutdown Monitor             : Always execute -> see (19)
  Shutdown Monitoring Method   : softdog     -> see (20)
  Action                       : RESET          -> see (21)
  Enable SIGTERM Handler      : Off         -> see (22)
  Use HB Timeout               : On          -> see (23)
  Timeout (sec)                : 90           -> see (24)
  Collect System Resource Information
                               : Off         -> see (25)
<Recovery>
  Max Reboot Count             : 1           -> see (26)
  Max Reboot Count Reset Time (min)
                               : 0           -> see (27)
  Use Forced Stop              : On          -> see (28)
```



```

Forced Stop Action                : BMC Power Off    -> see (29)
Forced Stop Timeout (sec)        : 30            -> see (30)
Execute Script for Forced Stop   : Off           -> See (31)
Action When the Cluster Service Process Is Failure
                                : Shut down the OS -> see (32)
Recovery Action for HA Agents:Max Restart Count
                                : 3            -> see (33)
Recovery Action for HA Agents:Recovery Action over Max Restart
Count
                                : No operation  -> see (34)
Start Automatically After System Down
                                : On           -> see (35)
Disable Recovery Action Caused by Monitor Resource Failure
                                : Off         -> see (36)
Action at Group Resource Activation or Deactivation Stall
                                : Stop the cluster service and
                                shutdown OS          -> see (37)
Restrain the shutdown action if only one server is alive
(when active group resource abnormality detected)
                                : Off         -> see (38)
Restrain the shutdown action if only one server is alive
(when deactive group resource abnormality detected)
                                : Off         -> see (39)
Restrain the shutdown action if only one server is alive
(when monitoring resource abnormality detected)
                                : Off         -> see (40)
<Alert Service>
E-mail Address                   :               -> see (41)
Use Network Warning Light       : On           -> see (42)
Use Alert Extension              : Off         -> see (43)
Use Chassis Identify            : Off         -> see (44)
Enable Alert Setting            : Off         -> see (45)
<Delay Warning>
Heartbeat Delay Warning         : 80          -> see (46)
Monitor Delay Warning           : 80          -> see (47)
<Exclusion>
Mount,Umount Exclusion          : On          -> see (48)
<Mirror Agent>
Auto Mirror Recovery            : On          -> see (49)
Collect Mirror Statistics       : ON          -> see (50)
Receive Timeout (sec)           : 10          -> see (51)
Send Timeout (sec)              : 30          -> see (52)
Recovery Data Size (kbyte)      : 4096        -> see (53)
Recovery Retry Count           : 1           -> see (54)
Start Wait Time (sec)           : 30          -> see (55)
Cluster Partition I/O Timeout (sec)
                                : 30          -> see (56)
<Mirror Driver>
Request Queue Maximum Number    : 2048        -> see (57)
Bitmap Update Interval (sec)    : 100         -> see (58)
Cluster Partition               : RESET       -> see (59)
Data Partition                  : RESET       -> see (60)
<Power Saving>
Use CPU Frequency Control       : off         -> see (61)
<JVM Monitor>

```

```

Java Install Path           : /usr/java/jdk1.6.0_31
                             -> see (62)
Maximum Java Heap Size (MB) : 7
                             -> see (63)
Load Balancer Connection Settings
                             : BIG-IP LTM
                             -> see (64)
Log Level                   : INFO
                             -> see (65)
Generation Count for Stored Log Files: 10
                             -> see (66)
Log Rotation Type           : File Size
                             -> see (67)
Log File Maximum Size (KB)  : 3072
                             -> see (68)
Time of First Log Rotation   : 00:00
                             -> see (69)
Log Rotation Interval (Hours) : 24
                             -> see (70)
Resource Measurement: Retry Count
                             : 10
                             -> see (71)
Resource Measurement: Threshold for Abnormal Judgment
                             : 1
                             -> see (72)
Resource Measurement: Default Interval: 30
                             -> see (73)
Resource Measurement: Interval for Full GC: 30
                             -> see (74)
WebLogic Monitoring: Retry Count : 3
                             -> see (75)
WebLogic Monitoring: Threshold for Abnormal Judgment
                             : 5
                             -> see (76)
WebLogic Monitoring: Request Count Measurement Interval
                             : 60
                             -> see (77)
WebLogic Monitoring: Interval for Average measurement
                             : 300
                             -> see (78)

Management Port             : 25500
                             -> see (79)
Connection Retry Count      : 3
                             -> see (80)
Time until Reconnect        : 60
                             -> see (81)
Management Port for Load Balancer Linkage: 25550
                             -> see (82)
Health Check Linkage Function : On
                             -> see (83)
Directory containing HTML files :
/tmp/tools/apache-tomcat-6.0.29/webapps/ROOT
                             -> see (84)
HTML File Name              : up.html
                             -> see (85)
HTML Renamed File Name      : down.html
                             -> see (86)
Retry count for renaming    : 3
                             -> see (87)
Wait time for retry         : 3
                             -> see (88)
Management IP address       : 10.1.2.26
                             -> see (89)
Connection Port             : 443
                             -> see (90)

```

◆ The items from Timeout down are displayed when the --detail option is used.

**Explanation of each item**

- |                               |  |
|-------------------------------|--|
| (1) Cluster:                  | Cluster name                                       |
| (2) Comment:                  | Comment  |
| <Heartbeat I/F>               |  |
| (3) Server Down Notification: | Server down notification                           |
| <NP Resolution>               |  |
| (4) Action at NP Occurrence:  | Action to be taken when a network partition occurs |
| <Timeout>                     |  |
| (5) Server Sync Wait Time:    | Time to wait for synchronization (in seconds)      |
| (6) Heartbeat Timeout:        | Heartbeat time-out (in milliseconds)               |
| (7) Heartbeat Interval:       | Heartbeat send interval (in milliseconds)          |

(8) Server Internal Timeout:	Internal communication time-out (in seconds)
(9) Timeout Ratio:	Current time-out ratio
<Port Number>	
(10) Server Internal Port Number:	Internal communication port number
(11) Data Transfer Port Number:	Data transfer port number
(12) Heartbeat Port Number:	Heartbeat port number
(13) Kernel Mode Heartbeat Port Number:	Kernel mode heartbeat port number
(14) WebManager HTTP Port Number:	WebManager HTTP port number
(15) Alert Sync Port Number:	Alert synchronous port number

The items of the information on mirror are displayed even if the Replicator or the Replicator DR are not used.

<Port No. (Mirror)>

(16) Mirror Agent Port Number:	Mirror agent port number
--------------------------------	--------------------------

<Port No. (Log)>

(17) Communication Method for Internal Logs:

Log communication method

(18) Port Number:	Port number
-------------------	-------------

<Monitoring>

(19) Shutdown Monitor:	Shutdown monitor
------------------------	------------------

(20) Shutdown Monitoring Method:	Shutdown monitor method
----------------------------------	-------------------------

(21) Action:	Action
--------------	--------

(22) Enable SIGTERM Handler:	Enable SIGTERM
------------------------------	----------------

(23) Use HB Timeout:	Use HB timeout
----------------------	----------------

(24) Timeout (sec):	Timeout (in seconds)
---------------------	----------------------

(25) Collect System Resource Information:	Collect System Resource Information
---	-------------------------------------

<Recovery>

(26) Max Reboot Count:	Maximum reboot count
------------------------	----------------------

(27) Max Reboot Count Reset Time (min):	Time (in minutes) to reset the maximum reboot count
---	---

(28) Use Forced Stop:	Forced stop
-----------------------	-------------

(29) Forced Stop Action:	Forced stop action
--------------------------	--------------------

(30) Forced Stop Timeout (sec):	Forced stop timeout (in seconds)
---------------------------------	----------------------------------

(31) Execute Script for Forced Stop	Script for forced stop
-------------------------------------	------------------------

(32) Action When the Cluster Service Process Is Failure:	Action to be taken when a cluster service process fails
--	---

(33) Recovery Action for HA Agents:Max Restart Count:	Action to be taken when the HA process fails: Process activation retry count
---	--

(34) Recovery Action for HA Agents:Recovery Action over Max Restart Count:	Action to be taken when the HA process fails: Action to be taken when the number of retries has exceeded the maximum retry count
--	--

(35) Start Automatically After System Down:	Start automatically after system down
---	---------------------------------------

(36) Disable Recovery Action Caused by Monitor Resource Failure:	Disables the recovery action when the monitor resource fails
--	--

- (37) Action at Group Resource Activation or Deactivation Stall: Action to be taken when group resource activation/deactivation is stalled
- (38) Restrain the shutdown action if only one server is alive  
(when active group resource abnormality detected):  
Whether to disable shutdown at activation failure in the case of the last one server
- (39) Restrain the shutdown action if only one server is alive  
(when deactive group resource abnormality detected):  
Whether to disable shutdown at deactivation failure in the case of the last one server
- (40) Restrain the shutdown action if only one server is alive  
(when monitoring resource abnormality detected):  
Whether to disable shutdown at monitoring failure in the case of the last one server

<Alert Service>

- (41) E-mail Address: Address to which notice mails are sent
- (42) Use Network Warning Light: Network warning light
- (43) Use Alert Extension: Alert extension function
- (44) Use Chassis Identify: Chassis Identify
- (45) Enable Alert Setting: Alert report configuration

<Delay Warning>

- (46) Heartbeat Delay Warning: Delay warning of heartbeat resource (%)
- (47) Monitor Delay Warning: Delay warning of monitor resource (%)

<Exclusion>

- (48) Mount, Umount Exclusion: Mount, unmount command exclusion

The items of the information on mirror are displayed when not using the Replicator or the Replicator DR as well.

<Mirror Agent>

- (49) Auto Mirror Recovery: Auto mirror recovery
- (50) Collect Mirror Statistics:
- (51) Receive Timeout (sec): Receive timeout (in seconds)
- (52) Send Timeout (sec): Send timeout (in seconds)
- (53) Recovery Data Size (kbyte): Recovery data size (in kilobytes)
- (54) Recovery Retry Count: Recovery retry count
- (55) Start Wait Time (sec): Time to wait for start synchronization(in seconds)
- (56) Cluster Partition I/O Timeout (sec): Cluster partition I/O timeout (in seconds)

<Mirror Driver>

- (57) Request Queue Maximum Number: The maximum number of the request queues
- (58) Bitmap Update Interval: Bitmap update interval (in seconds)
- (59) Cluster Partition: Action to be taken when an I/O error occurs in a cluster partition.
- (60) Data Partition: Action to be taken when an I/O error occurs in a data partition.

<Power Saving>

---

(61) Use CPU Frequency Control: <JVM Monitor>	CPU Frequency Control
(62) Java Install Path:	Java installation path
(63) Maximum Java Heap Size (MB):	Maximum Java heap size (MB)
(64) Load Balancer Connection Settings:	Load balancer linkage settings
(65) Log Level:	Log level
(66) Generation Count for Stored Log Files:	Number of generations of log files to be stored
(67) Log Rotation Type:	Log rotation type
(68) Log File Maximum Size (KB):	Maximum log file size (KB)
(69) Time of First Log Rotation:	Time at which first log rotation is performed
(70) Log Rotation Interval (Hours):	Log rotation interval (hours)
(71) Resource Measurement: Retry Count:	Number of times that measurement is retried
(72) Resource Measurement: Threshold for Abnormal Judgment:	Threshold for error detection
(73) Resource Measurement: Default Interval:	Measurement interval for memory and thread (seconds)
(74) Resource Measurement: Interval for Full GC:	Full GC measurement interval (seconds)
(75) WebLogic Monitoring: Retry Count:	Number of times that measurement is retried
(76) WebLogic Monitoring: Threshold for Abnormal Judgment:	Threshold for error detection
(77) WebLogic Monitoring: Request Count Measurement Interval:	Request count measurement interval (seconds)
(78) WebLogic Monitoring: Interval for Average measurement:	Average measurement interval (seconds)
(79) Management Port:	Management port number
(80) Connection Retry Count:	Connection retry count
(81) Time until Reconnect:	Length of time to wait for reconnection (seconds)
(82) Management Port for Load Balancer Linkage:	Management port number for load balancer linkage
(83) Health Check Linkage Function:	Whether to link to the health check function
(84) Directory containing HTML files:	Directory containing HTML files
(85) HTML File Name:	HTML file name
(86) HTML Renamed File Name:	HTML renamed file name
(87) Retry count for renaming:	Number of times retry is attempted when renaming fails
(88) Wait time for retry:	Length of time to wait for renaming retry (seconds)
(89) Management IP address:	BIG-IP LTM management IP address
(90) Connection Port:	Communication port number for BIG-IP LTM

## Displaying only the configuration data of certain servers (--sv option)

When you want to display only the cluster configuration data on a specified server, specify the name of the server after the --sv option in the `clpstat` command. If you want to see the details, specify the --detail option. When the name of the server is not specified, cluster configuration data of all servers are displayed.

### Example of a command entry

```
# clpstat --sv server1 --detail
```

### Example of the display after running the command:

```
===== CLUSTER INFORMATION =====
[Server0 : server1]                                -> see (1)
  Comment                                          : server1          -> see (2)
  Virtual Infrastructure                            : vSphere          -> see (3)
  Product                                          : EXPRESSCLUSTER X 3.3 for Linux
                                                    -> see (4)
  Internal Version                                : 3.3.2-1         -> see (5)
  Edition                                          : X                -> see (6)
  Platform                                         : Linux            -> see (7)
  IP Address                                       : 10.0.0.1         -> see (8)
  Mirror Disk Connect IP Address mdc[1]
                                                    : 192.168.0.1     -> see (9)
  Network Warning Light IP Address(Type)
                                                    : 10.0.0.10(dn1000s) -> see (10)
  Disk I/O Lockout Device                          :                  -> see (11)
  BMC IP Address                                  : 10.0.0.11       -> see (12)
  CPU Frequency Status                            : -               -> see (13)
  No shutdown when double activation detected
                                                    : Off              -> see (14)
```

- ◆ The descriptions circled by the red dot-line are not displayed when the --detail option is used.

### Explanation of each item

- |  |   |
|--|---|
| (1) [Server n: hostname] (n is index number of a server) |   |
| (2) Comment:   | Comment   |
| (3) Virtual Infrastructure:                              | Virtual infrastructure name   |
| (4) Product:   | Product   |
| (5) Internal Version:                                    | Internal version  |
| (6) Edition:   | Edition   |
| (7) Platform:  | Name of the distribution<br>When the OS name cannot be obtained, only "Linux" is displayed. |
| (8) IP Address:  | Interconnect address  |
| (9) Mirror Disk Connect IP Address mdc n:                | Mirror connect address  |
| (10) Network Warning Light IP Address(Type):             | Network warning light IP address(Type)  |
| (11) Disk I/O Lockout Device:                            | Disk I/O lockout device   |

- |      |  |  |
|------|--|--|
| (12) | BMC IP Address:                              | BMC IP address   |
| (13) | CPU Frequency Status:                        | CPU Frequency Status   |
| (14) | No shutdown when double activation detected: | Disables the shutdown operation when the condition that both systems are active is detected. |

## Displaying only the resource information of certain heartbeats (--hb option)

When you want to display only the cluster configuration data on a specified heartbeat resource, specify the name of the heartbeat resource after the `--hb` option in the `clpstat` command. If you want to see the details, specify the `--detail` option.

### Example of a command entry (For a LAN heartbeat resource)

```
# clpstat --hb lanhb1 --detail
```

### Example of the display after running the command:

```
===== CLUSTER INFORMATION =====
[HB0 : lanhb1]                                -> see (1)
  Type      : lanhb                            -> see (2)
  Comment   : LAN Heartbeat                    -> see (3)
<server1>
  IP Address : 192.168.0.1                      -> see (4)
<server2>
  IP Address : 192.168.0.2
```

- ◆ The items described in the 1<sup>st</sup> line to the 3<sup>rd</sup> line are common to all heartbeat resources.
- ◆ The lines from the server 1 under are displayed when the `--detail` option is used.

### Information common to any heartbeat resource

- (1) [HB n: heartbeat\_resource\_name]  
(n is the identification number of a heartbeat resource)
- (2) Type : Heartbeat resource type
- (3) Comment : Comment

### Information displayed when the `--detail` option is used

- (4) IP Address : Interconnect address

### Example of a command entry (For disk heartbeat resource)

```
# clpstat --hb diskhb --detail
```

### Example of the display after running the command:

```
===== CLUSTER INFORMATION =====
[HB2 : diskhb1]
  Type      : diskhb
  Comment   : Disk Heartbeat
<server1>
  Device Name      : /dev/sdb1                    -> see (1)
  Raw Device Name  : /dev/raw/raw1                -> see (2)
<server2>
  Device Name      : /dev/sdb1
  Raw Device Name  : /dev/raw/raw1
```

- ```
=====
```
- (1) Device Name : Disk heartbeat device
  - (2) Raw Device Name : Raw device for the disk heartbeat

**Example of a command entry (For COM heartbeat resource)**

**# clpstat --hb comhb --detail**

**Example of the display after running the command:**

```
===== CLUSTER INFORMATION =====
[HB3 : comhb1]
Type                : comhb
Comment             : COM Heartbeat
<server1>
Device Name         : /dev/ttyS0                -> see (1)
<server2>
Device Name         : /dev/ttyS0
=====
```

- (1) Device Name : COM heartbeat device

**Example of a command entry (For kernel mode LAN heartbeat resource)**

**# clpstat --hb lankhb --detail**

**Example of the display after running the command:**

```
===== CLUSTER INFORMATION =====
[HB4 : lankhb1]
Type                : lankhb
Comment             : Kernel Mode LAN Heartbeat
<server1>
IP Address          : 192.168.0.11              -> see (1)
<server2>
IP Address          : 192.168.0.12
=====
```

- (1) IP Address : Interconnect address

**Example of a command entry (For a BMC heartbeat resource)**

**# clpstat --hb bmchb1 --detail**

**Example of the display after running the command:**

```
===== CLUSTER INFORMATION =====
[HB0 : bmchb1]
Type                : bmchb
Comment             : BMC Heartbeat
<server1>
IP Address          : 192.168.0.1              -> see (1)
<server2>
IP Address          : 192.168.0.2
=====
```

**Explanation of each item**

- (1) IP Address : BMC IP address



## ◆ Tips

By using the `--sv` option and the `--hb` option together, you can see the information as follows.

Command Line # `clpstat --sv --hb --detail`

```

===== CLUSTER INFORMATION =====
[Server0 : server1]
  Comment                : server1
  Virtual Infrastructure   :
  Product                 : EXPRESSCLUSTER X 3.3 for Linux
  Internal Version        : 3.3.2-1
  Edition                 : X
  Platform                : Linux
  IP Address              : 10.0.0.1
  Mirror Disk Connect IP Address mdc[1]
                          : 192.168.0.1
  Network Warning Light IP Address(Type)
                          : 10.0.0.10(dn1000s)
  Disk I/O Lockout Device :
  BMC IP Address          : 10.0.0.11
  CPU Frequency Status    : -
  No shutdown when double activation detected
                          : Off

  [HB0 : lanhb1]
    Type                  : lanhb
    Comment                : LAN Heartbeat
    IP Address            : 192.168.0.1
  [HB1 : lanhb2]
    Type                  : lanhb
    Comment                : LAN Heartbeat
    IP Address            : 10.0.0.1
  [HB2 : diskhb1]
    Type                  : diskhb
    Comment                : Disk Heartbeat
    Device Name           : /dev/sdb1
  [HB3 : comhb1]
    Type                  : comhb
    Comment                : COM Heartbeat
    Device Name           : /dev/ttyS0
[Server1 : server2]
  Comment                : server2
  Virtual Infrastructure   :
  Product                 : EXPRESSCLUSTER X 3.3 for Linux
  Internal Version        : 3.3.2-1
  Edition                 : X
  Platform                : Linux
  IP Address              : 10.0.0.2
  Mirror Disk Connect IP Address mdc[1]
                          : 192.168.0.2
  Network Warning Light IP Address(Type)
                          : 10.0.0.10(dn1000s)
  Disk I/O Lockout Device :
  BMC IP Address          : 10.0.0.12
  CPU Frequency Status    : -
  No shutdown when double activation detected
                          : Off

  [HB0 : lanhb1]
    Type                  : lanhb
    Comment                : LAN Heartbeat
    IP Address            : 192.168.0.2
  [HB1 : lanhb2]
    Type                  : lanhb
    Comment                : LAN Heartbeat
    IP Address            : 10.0.0.2
  [HB2 : diskhb1]
    Type                  : diskhb
    Comment                : Disk Heartbeat

```

```
Device Name           : /dev/sdb1
[HB3 : comhb1]
Type                  : comhb
Comment               : COM Heartbeat
Device Name           : /dev/ttyS0
=====
```

## Displaying only the configuration data of certain server group (--svg option)

To display only the cluster configuration data on a specified server group, specify the name of server group after --svg option in the `clpstat` command. When you do not specify the name of server group, the cluster configuration data of all the server groups is displayed.

### Example of a command entry

```
# clpstat --svg servergroup1
```

### Example of the display after running the command:

```
===== CLUSTER INFORMATION =====
[ServerGroup0 : servergroup1]      -> see (1)
  server0 : server1                 -> see (2)
  server1 : server2                 -> see (2)
  server2 : server3                 -> see (2)
=====
```

- (1) [ServerGroup n : the name of server group]  
(n is the identification number of a server group)
- (2) server n : server name (n is the priority number of a server group)

## Displaying only the configuration data of certain groups (--grp option)

When you want to display only the cluster configuration data on a specified group, specify the name of the group after the --grp option in the `clpstat` command. If you want to see the details, specify the --detail option. When you do not specify the name of group, the cluster configuration data of all the groups is displayed.

### Example of a command entry

```
# clpstat --grp failover1 --detail
```

### Example of the display after running the command:

```
===== CLUSTER INFORMATION =====
[Group0 : failover1]                                -> see (1)
  Type   : failover          -> see (2)
  Comment  : failover group1   -> see (3)
  Startup Attribute                               : Auto Startup      -> see (4)
  Failover Exclusive Attribute                   : Off                -> see (5)
  Failback Attribute                             : Manual Failback    -> see (6)
  Failover Attribute                             : Manual Failover    -> see (7)
  Servers that can run the Group: 0 server1       -> see (8)
  Servers that can run the Group: 1 server2
```

◆ The items from Comment down are displayed when the --detail option is used.

- (1) [Group n : group name] (n is the identification number of a group)
- (2) Type : Group type
- (3) Comment : Comment
- (4) Startup Attribute : Startup type
  - Manual Startup : Manual startup
  - Auto Startup : Automatic startup
- (5) Failover Exclusive Attribute : Startup exclusive attributes
  - No Exclusion : No exclusion
  - Normal : Normal exclusion
  - Absolute : Complete exclusion
- (6) Failback Attribute : Failback attribute
  - Manual Failback : Manual failback
  - Auto Failback : Automatic failback
- (7) Failover Attribute : Failover attribute
  - Manual Failover : Manual failover
  - Auto Failover : Automatic failover
- (8) Servers that can run the Group : Failover order

Servers that can run the Group are displayed in the failover policy sequence.

## Displaying only the configuration data of a certain group resource (--rsc option)

When you want to display only the cluster configuration data on a specified group resource, specify the group resource after the `--rsc` option in the `clpstat` command. If you want to see the details, specify the `--detail` option. When you do not specify the name of server group, the cluster configuration data of all the group resources is displayed.

### Example of a command entry (For disk resource)

```
# clpstat --rsc disk1 --detail
```

### Example of the display after running the command:

```
===== CLUSTER INFORMATION =====
[Resource0 : disk1] (1)
Type : disk (2)
Comment : /dev/sdb5 (3)
Failover Threshold : 1 (4)
Retry Count at Activation Failure : 0 (5)
Final Action at Activation Failure : No Operation (6)
                                     (Next Resources Are Not Activated)
Execute Script before Final Action : Off (7)
Retry Count at Deactivation Failure : 0 (8)
Final Action at Deactivation Failure: No Operation (9)
                                     (Next Resources Are Not Activated)
Execute Script before Final Action : Off (10)
Depended Resources : fipl (11)
Disk Type : disk (12)
File System : ext3 (13)
Device Name : /dev/sdb5 (14)
Raw Device Name : (15)
Mount Point : /mnt/sdb5 (16)
Mount Option : rw (17)
Mount Timeout (sec) : 60 (18)
Mount Retry Count : 3 (19)
Fsync Action When Mount Failed : Execute (20)
Unmount Timeout (sec) : 120 (21)
Unmount Retry Count : 3 (22)
Unmount Retry Interval : 5 (23)
Action at Unmount Failure : kill (24)
Fsync Option : -y (25)
Fsync Timeout (sec) : 7200 (26)
Fsync Action Before Mount :
                                     Execute at Specified Count (27)
Fsync Interval : 3 (28)
Re-restoration of Reiserfs : None (29)
Xfs_repair Action When Mount Failed: Execute (30)
Xfs_repair Option : (31)
Xfs_repair Timeout (sec) : 7200 (32)
=====
```

- ◆ The items written in the 1<sup>st</sup> to 11<sup>th</sup> line are common to all group resources.
- ◆ The items described in the 4<sup>th</sup> to the 11<sup>th</sup> line and the 17<sup>th</sup> to the 29<sup>th</sup> line are displayed when the `--detail` option is used.

### Information displayed for any group resources

- (1) [Resource n : *group\_resource\_name*]  
(n is the identification number of group resource)
- (2) Type : Group resource type
- (3) Comment : Comment
- (4) Failover Threshold : Failover count
- (5) Retry Count at Activation Failure : Activation retry count
- (6) Final Action at Activation Failure: Final action at activation failures

**No Operation (Next Resources Are Activated)**

No action is taken (next resources will be activated).

**No Operation (Not activate next resource)**

No action is taken( next resource will not be activated)

**Stop Group**

The group will be stopped.

**Stop the cluster daemon**

The cluster daemon will be stopped.

**Stop the cluster daemon and shut down OS**

The cluster daemon will be stopped and the OS will be shut down.

**Stop the cluster daemon and reboot OS**

The cluster daemon will be stopped and the OS will be restarted.

**Sysrq Panic**

The panic of sysrq is performed.

**Keepalive Reset**

The server is reset by using the clpkhb or clpka driver.

**Keepalive Panic**

The server panic is performed by using the clpkhb or clpka driver.

**BMC Reset**

The server is reset by using the ipmi command.

**BMC Power Off**

The server is powered off by using the ipmi command.

**BMC Power Cycle**

The server power cycle (power on/off) is performed by using the ipmi command.

**BMC NMI**

The NMI is generated by using the ipmi command.

**I/O Fencing(High-End Server Option)**

Use this on the server in network partition to generate I/O Fencing and NMI..

- (7) Execute Script before Final Action : Execute script before final action
- (8) Retry Count at Deactivation Failure: Inactivation retry count
- (9) Final Action at Deactivation Failure: Final action at inactivation failures

**No Operation (Next Resources Are Deactivated)**

No action is taken (the next resource is deactivated).

**No Operation (Next Resources Are Not Deactivated)**

No action is taken (the next resource is not deactivated).

**Stop the cluster daemon and shut down OS**

The cluster daemon will be stopped and the OS will be shut down.

**Stop the cluster daemon and reboot OS**

The cluster daemon will be stopped and the OS will be restarted.

**Sysrq Panic**

The panic of sysrq is performed.

**Keepalive Reset**

The server is reset by using the clpkhb or clpka driver.

**Keepalive Panic**

The server panic is performed by using the clpkhb or clpka driver.

**BMC Reset**

The server is reset by using the ipmi command.

**BMC Power Off**

The server is powered off by using the ipmi command.

**BMC Power Cycle**

The server power cycle (power on/off) is performed by using the ipmi command.

**BMC NMI**

The NMI is generated by using the ipmi command.

**I/O Fencing(High-End Server Option)**

Use this on the server in network partition to generate I/O Fencing and NMI..

(10) Execute Script before Final Action : Execute script before final action

(11) Depended Resources : Depended resource

**Explanation of each item**

(12) Disk Type : Disk type

(13) File System : File system

(14) Device Name : Device name

(15) Raw Device Name : RAW Device name

(16) Mount Point : Mount point

(17) Mount Option : Mount option

(18) Mount Timeout (sec) : Mount time-out (in seconds)

(19) Mount Retry Count : Mount retry count

(20) Fsck Action When Mount Failed : Fsck action at mount failure

(21) Unmount Timeout (sec) : Unmount time-out (in seconds)

(22) Unmount Retry Count : Unmount retry count

(23) Unmount Retry Interval : Unmount retry interval (in seconds)

(24) Action at Unmount Failure : Action at unmount failure

- kill : Forces termination of the process accessing the mount point
- none : Takes no action

(25) Fsck Option : fsck option

(26) Fsck Timeout : fsck time-out (in seconds)

(27) Fsck Action Before Mount : fsck action before mounting

- 0 : Does not execute fsck
- 1 : Always executes fsck
- 2 : Executes fsck once the specified count is reached

(28) Fsck Interval : fsck interval

(29) Re-restoration of Reiserfs : Re-install Reiserfs

- Execute: Executes
- None: Takes no action

(30) Xfs\_repair Action When Mount Failed : xfs\_repair action to be taken when mounting failed

- Execute: Executes
- None: Takes no action

(31) Xfs\_repair Option : xfs\_repair option

(32) Xfs\_repair Timeout (sec) : xfs\_repair timeout (seconds)



**Example of a command entry (When mirror disk resource Replicator is used)****# clpstat --rsc mdl --detail****Example of the display after running the command:**

```

===== CLUSTER INFORMATION =====
[Resource0 : mdl]
  Type                : md
  Comment              : /dev/NMP1
  Failover Threshold  : 1
  Retry Count at Activation Failure : 0
  Final Action at Activation Failure : No Operation
                                     (Next Resources Are Not Activated)
  Execute Script before Final Action : Off
  Retry Count at Deactivation Failure : 0
  Final Action at Deactivation Failure : No Operation
                                     (Next Resources Are Not Activated)
  Execute Script before Final Action : Off
  Depended Resources  : fip1
  Mirror Partition Device Name : /dev/NMP1      -> see (1)
  Mount Point         : /mnt/sdb5      -> see (2)
  Data Partition Device Name : /dev/sdb5     -> see (3)
  Cluster Partition Device Name : /dev/sdb1    -> see (4)
  File System         : ext3           -> see (5)
  Mirror Disk Connect : mdcl         -> see (6)
  Mount Option        : rw             -> see (7)
  Mount Timeout (sec) : 120           -> see (8)
  Mount Retry Count   : 3             -> see (9)
  Unmount Timeout (sec) : 120         -> see (10)
  Unmount Retry Count : 3            -> see (11)
  Unmount Retry Interval : 5         -> see (12)
  Action at Umount Failure : kill    -> see (13)
  Fsck Option         : -y            -> see (14)
  Fsck Timeout (sec)  : 7200         -> see (15)
  Fsck Action Before Mount :
  Execute at Specified Count -> see (16)
  Fsck Interval       : 10           -> see (17)
  Fsck Action When Mount Failed : Execute -> see (18)
  Re-restoration of Reiserfs : Execute -> see (19)
  Initial Mirror Recovery : Yes     -> see (20)
  Initial Mkfs        : Yes         -> see (21)
  Synchronization Data : Yes     -> see (22)
  Synchronization Mode : Synchronous -> see (23)
  Number of Queues     : 65535      -> see (24)
  Mode of Communication Band : No     -> see (25)
  Upper Bound of Communication Band (KB/sec) : Unlimited
   -> see (26)
  Compress Data       : No          -> see (27)
  Mirror Data Port Number : 29051   -> see (28)
  Mirror Heartbeat Port Number : 29031  -> see (29)
  Mirror ACK2 Port Number : 29071   -> see (30)
  Send Timeout (sec)   : 30         -> see (31)
  Connection Timeout (sec) : 10      -> see (32)
  ACK Timeout (sec)    : 100       -> see (33)
  Receive Timeout (sec) : 100     -> see (34)
  Mirror Heartbeat Interval (sec) : 10    -> see (35)

```

ICMP Echo Reply Receive Timeout (sec) : 2                   -> see (36)  
 ICMP Echo Request Retry Count        : 8                   -> see (37)

=====

- (1) Mirror Partition Device Name        : Mirror partition device name
- (2) Mount Point                         : Mount point
- (3) Data Partition Device Name         : Data partition device name
- (4) Cluster Partition Device Name      : Cluster partition device name
- (5) File System                         : File system
- (6) Mirror Disk Connect                : Mirror disk connect
- (7) Mount Option                        : Mount option
- (8) Mount Timeout (sec)                : Mount time-out (in seconds)
- (9) Mount Retry Count                  : Mount retry count
- (10) Unmount Timeout (sec)             : Unmount time-out (in seconds)
- (11) Unmount Retry Count               : Unmount retry count
- (12) Unmount Retry Interval            : Unmount retry interval (in seconds)
- (13) Action at Umount Failure          : Action to be taken at an unmount failure
  - kill                                 : Forces termination of the process accessing the mount point
  - none                                 : Takes no action
- (14) fsck Option                        : fsck option
- (15) fsck Timeout                      : fsck time-out ( in seconds)
- (16) fsck Action Before Mount         : fsck action before mounting
  - Not Execute                         : Does not execute fsck
  - Always Execute                     : Always executes fsck
  - Execute at Specified Count         : Executes fsck once the specified count is reached
- (17) fsck Interval                     : fsck interval
- (18) Fsck Action When Mount Failed    : fsck action to be taken at a mount failure
- (19) Re-restoration of Reiserfs        : Re-restore Reiserfs
  - Execute: Executes
  - None: Takes no action
- (20) Initial Mirror Recovery           : Initial mirror construction
- (21) Initial Mkfs                      : Initial mkfs
- (22) Synchronization Data             : Data synchronization
- (23) Synchronization Mode             : Synchronization mode
- (24) Number of Queues                 : Number of queues
- (25) Mode of Communication Band        : Mode of Communication Band
- (26) Upper Bound of Communication Band (KB/sec)
  - : Bound of the communication band (KB/sec)
- (27) Compress Data                     : Compress mode
  - No                                 : Neither mirroring data nor recovery data is compressed.
  - Only sync data                     : Only mirroring data is compressed.
  - Only recovery data                 : Only recovery data is compressed.
  - Yes                                 : Both mirroring data and recovery data are compressed.

- (28) Mirror Data Port Number : Mirror data port number
- (29) Mirror Heartbeat Port Number : Mirror heartbeat port number
- (30) Mirror ACK2 Port Number : Mirror ACK2 port number
- (31) Send Timeout (sec) : Send timeout (sec)
- (32) Connection Timeout (sec) : Connection timeout (sec)
- (33) ACK Timeout (sec) : ACK timeout (sec)
- (34) Receive Timeout (sec) : Receive timeout (sec)
- (35) Mirror Heartbeat Interval (sec) : Mirror heartbeat interval (sec)
- (36) ICMP Echo Reply Receive Timeout (sec): ICMP Echo Reply receive timeout (sec)
- (37) ICMP Echo Request Retry Count : ICMP Echo Request retry count

**Example of a command entry (Hybrid disk resource For Replicator DR)****# clpstat --rsc hd1 --detail****Example of the display after running the command:**

```

===== CLUSTER INFORMATION =====
[Resource0 : hd1]
Type : hd
Comment : /dev/NMP1
Failover Threshold : 1
Retry Count at Activation Failure : 0
Final Action at Activation Failure : No Operation
                                     (Next Resources Are Not Activated)
Execute Script before Final Action : Off
Retry Count at Deactivation Failure : 0
Final Action at Deactivation Failure : No Operation
                                     (Next Resources Are Not Activated)
Execute Script before Final Action : Off
Depended Resources : fip1
Mirror Partition Device Name : /dev/NMP1 (1)
Mount Point : /mnt/sdb5 (2)
Data Partition Device Name : /dev/sdb5 (3)
Cluster Partition Device Name : /dev/sdb1 (4)
File System : ext3 (5)
Mirror Disk Connect : mdc1 (6)
Mount Option : rw (7)
Mount Timeout (sec) : 120 (8)
Mount Retry Count : 3 (9)
Unmount Timeout (sec) : 120 (10)
Unmount Retry Count : 3 (11)
Unmount Retry Interval : 5 (12)
Action at Umount Failure : kill (13)
Fsck Option : -y (14)
Fsck Timeout (sec) : 7200 (15)
Fsck Action Before Mount :
                                     Execute at Specified Count (16)
Fsck Interval : 10 (17)
Fsck Action When Mount Failed : Execute (18)
Re-restoration of Reiserfs : Execute (19)
Initial Mirror Recovery : Yes (20)
Initial Mkfs : Yes (21)
Synchronization Data : Yes (22)
Synchronization Mode : Synchronous (23)
Number of Queues : 65535 (24)
Mode of Communication Band : No (25)
Upper Bound of Communication Band (KB/sec) : Unlimited (26)
Compress Data : No (27)
Mirror Data Port Number : 29051 (28)
Mirror Heartbeat Port Number : 29031 (29)
Mirror ACK2 Port Number : 29071 (30)
Send Timeout (sec) : 30 (31)
Connection Timeout (sec) : 10 (32)
ACK Timeout (sec) : 100 (33)
Receive Timeout (sec) : 100 (34)
Mirror Heartbeat Interval (sec) : 10 (35)
ICMP Echo Reply Receive Timeout (sec) : 2 (36)
ICMP Echo Request Retry Count : 8 (37)
=====

```

- 
- (1) Mirror Partition Device Name : Mirror partition device name
- (2) Mount Point : Mount point
- (3) Data Partition Device Name : Data partition device name
- (4) Cluster Partition Device Name : Cluster partition device name
- (5) File System : File system
- (6) Mirror Disk Connect : Mirror disk connect
- (7) Mount Option : Mount option
- (8) Mount Timeout (sec) : Mount time-out (in seconds)
- (9) Mount Retry Count : Mount retry count
- (10) Unmount Timeout (sec) : Unmount time-out (in seconds)
- (11) Unmount Retry Count : Unmount retry count
- (12) Unmount Retry Interval : Unmount retry interval (in seconds)
- (13) Action at Umount Failure : Action to be taken at an unmount failure
- kill : Forces termination of the process accessing the mount point
  - none : Takes no action
- (14) fsck Option : fsck option
- (15) fsck Timeout : fsck time-out ( in seconds)
- (16) fsck Action Before Mount : fsck action before mounting
- Not Execute : Does not execute fsck
  - Always Execute : Always executes fsck
  - Execute at Specified Count : Executes fsck once the specified count is reached
- (17) fsck Interval : fsck interval
- (18) Fsck Action When Mount Failed : fsck action to be taken at a mount failure
- (19) Re-restoration of Reiserfs : re-restore Reiserfs
- Execute: Executes
  - None: Takes no action
- (20) Initial Mirror Recovery : Initial mirror construction
- (21) Initial Mkfs : Initial mkfs
- (22) Synchronization Data : Data synchronization
- (23) Synchronization Mode : Synchronization mode
- (24) Number of Queues : Number of queues
- (25) Mode of Communication Band : Mode of Communication Band
- (26) Upper Bound of Communication Band (KB/sec)  
: Bound of the communication band (KB/sec)
- (27) Compress Data : Compress mode
- No : Neither mirroring data nor recovery data is compressed.
  - Only sync data : Only mirroring data is compressed.
  - Only recovery data : Only recovery data is compressed.
  - Yes : Both mirroring data and recovery data are compressed.
- (28) Mirror Data Port Number : Mirror data port number
- (29) Mirror Heartbeat Port Number : Mirror heartbeat port number
- (30) Mirror ACK2 Port Number : Mirror ACK2 port number

- (31) Send Timeout (sec) : Send timeout (sec)
- (32) Connection Timeout (sec) : Connection timeout (sec)
- (33) ACK Timeout (sec) : ACK timeout (sec)
- (34) Receive Timeout (sec) : Receive timeout (sec)
- (35) Mirror Heartbeat Interval (sec) : Mirror heartbeat interval (sec)
- (36) ICMP Echo Reply Receive Timeout (sec): ICMP Echo Reply receive timeout (sec)
- (37) ICMP Echo Request Retry Count : ICMP Echo Request retry count

**Example of a command entry (For floating IP resource)****# clpstat --rsc fip1 --detail****Example of the display after running the command:**

```

===== CLUSTER INFORMATION =====
[Resource2 : fip1]
Type                : fip
Comment             : 10.0.0.11
Failover Threshold  : 1
Retry Count at Activation Failure : 5
Final Action at Activation Failure : No Operation
                                (Next Resources Are Not Activated)
Execute Script before Final Action : Off
Retry Count at Deactivation Failure : 0
Final Action at Deactivation Failure: Stop Cluster Daemon And
                                OS No Operation
Execute Script before Final Action : Off
Depended Resources  :
IP Address          : 10.0.0.11      -> see (1)
Ping Timeout (sec)  : 1              -> see (2)
Ping Retry Count    : 5              -> see (3)
Ping Interval (sec) : 1              -> see (4)
FIP Force Activation : On            -> see (5)
ARP Send Count      : 3              -> see (6)
Ifconfig Timeout (sec) : 60          -> see (7)
Ifconfig Status at Failure : Failure    -> see (8)
Ping Status at Failure : Failure    -> see (9)
=====

```

- (1) IP Address : FIP address
- (2) Ping Timeout (sec) : Time-out of ping to confirm redundancy (in seconds)
- (3) Ping Retry Count : Ping retry count
- (4) Ping Interval (sec) : Ping interval (in seconds)
- (5) FIP Force Activation : FIP force activation
- (6) ARP Send Count : ARP send count
- (7) Ifconfig Timeout (sec) : Ifconfig timeout (in seconds)
- (8) Ifconfig Status at Failure : Operation at Ifconfig failure
- Failure  
Operates as an activation failure
  - Not Failure  
Does not operate as an activation failure
- (9) Ping Status at Failure : Operation at ping failure
- Failure  
Operates as an activation failure
  - Not Failure  
Does not operate as an activation failure

**Example of a command entry (For EXEC resource)****# clpstat --rsc execl --detail****Example of the display after running the command:**

```

===== CLUSTER INFORMATION =====
[Resource1 : execl]
Type : exec
Comment : exec resource1
Failover Threshold : 1
Retry Count at Activation Failure : 0
Final Action at Activation Failure : No Operation
                                (Next Resources Are Not Activated)
Execute Script before Final Action : Off
Retry Count at Deactivation Failure : 0
Final Action at Deactivation Failure: Stop Cluster Daemon And
                                OS No Shutdown
Execute Script before Final Action : Off
Depended Resources : disk1, fip1
Start Script Path : /opt/userpp/start.sh
                                -> see (1)
Stop Script Path : /opt/userpp/stop.sh
                                -> see (2)
Start Type : Asynchronous -> see (3)
Stop Type : Synchronous -> see (4)
Start Script Timeout (sec) : 1800 -> see (5)
Stop Script Timeout (sec) : 1800 -> see (6)
Log Output Path : /tmp/log/test.txt -> see (7)
Script Log Rotate : off -> see (8)
Script Log Rotate Size (byte) : 1000000 -> see (9)
Script Log Rotate Generation : 2 -> see (10)
=====

```

- (1) Start Script Path : Path to the Start Script
- (2) Stop Script Path : Path to the Stop Script
- (3) Start Type : Synchronization/asynchronization of Start Script
- Synchronous : Synchronous
  - Asynchronous : Asynchronous
- (4) Stop Type : Synchronization/asynchronization of Stop Script
- Synchronous : Synchronous
  - Asynchronous : Asynchronous
- (5) Start Script Timeout (sec) : Start Script time-out (in seconds)
- (6) Stop Script Timeout (sec) : Stop Script time-out (in seconds)
- (7) Log Output Path : Location where script log will be output
- (8) Script Log Rotate : Rotate script log
- On : Rotate script log
  - Off : Do not rotate script log
- (9) Script Log Rotate Size (byte) : Size of script log
- (10) Script Log Rotate Generation : Generation number of script log



**Example of a command entry (For NAS resource)**

```
# clpstat --rsc nas1 --detail
```

**Example of the display after running the command:**

```
===== CLUSTER INFORMATION =====
[Resource6 : nas1]
Type : nas
Comment : nfsserver1:/share1
Failover Threshold : 1
Retry Count at Activation Failure : 0
Final Action at Activation Failure : No Operation
                                     (Next Resources Are Not Activated)
Execute Script before Final Action : Off
Retry Count at Deactivation Failure : 0
Final Action at Deactivation Failure: Stop Cluster Daemon And
                                     OS No Shutdown
Execute Script before Final Action : Off
Depended Resources : fip1
Server Name : nfsserver1 -> see (1)
Shared Name : /share1 -> see (2)
File System : nfs -> see (3)
Mount Point : /mnt/nas1 -> see (4)
Mount Option : rw -> see (5)
Mount Timeout (sec) : 60 -> see (6)
Mount Retry Count : 3 -> see (7)
Unmount Timeout (sec) : 60 -> see (8)
Unmount Retry Count : 3 -> see (9)
Unmount Retry Interval : 5 -> see (10)
Action at Unmount Failure : kill -> see (11)
Ping Timeout (sec) : 10 -> see (12)
=====
```

**Explanation of each item**

- (1) Server Name : Server name
- (2) Shared Name : Shared name
- (3) File System : File system
- (4) Mount Point : Mount point
- (5) Mount Option : Mount option
- (6) Mount Timeout (sec) : Mount time-out (in seconds)
- (7) Mount Retry Count : Mount retry count
- (8) Unmount Timeout (sec) : Unmount time-out (in seconds)
- (9) Unmount Retry Count : Unmount retry count
- (10) Unmount Retry Interval : Unmount retry interval (in seconds)
- (11) Action at Umount Failure : Action to be taken at unmount failure
  - kill : Forces termination of the process accessing the mount point
  - none : Takes no action
- (12) Ping Timeout (sec) : ping time-out (in seconds)

**Example of a command entry (For Virtual IP resource)****# clpstat --rsc vip1 --detail****Example of the display after running the command:**

```

===== CLUSTER INFORMATION =====
[Resource7 : vip]
  Type : vip
  Comment : vip1
  Failover Threshold : 1
  Execute Script before Final Action : Off
  Retry Count at Activation Failure : 1
  Final Action at Activation Failure : No Operation
                                     (Next Resources Are Not Activated)
  Retry Count at Deactivation Failure: 0
  Final Action at Deactivation Failure: No Operation
                                     (Next Resources Are Deactivated)
Execute Script before Final Action : Off
  Depended Resources :
  IP Address : Refer to server`s setting
                                     -> see (1)
  NIC Alias Name : Refer to server`s setting
                                     -> see (2)
  Destination IP Address : Refer to server`s setting
                                     -> see (3)
  Source IP Address : Refer to server`s setting
                                     -> see (4)
  Send Interval : Refer to server`s setting
                                     -> see (5)
  Routing Protocol : Refer to server`s setting
                                     -> see (6)
  Ping Timeout (sec) : 1 -> see (7)
  Ping Retry Count : 0 -> see (8)
  Ping Interval (sec) : 1 -> see (9)
  VIP Force Activation : On -> see (10)
  ARP Send Count : 1 -> see (11)
  Ifconfig Timeout (sec) : 30 -> see (12)
  Ifconfig Status at Failure : Failure -> see (13)
  Ping Status at Failure : Failure -> see (14)
  RIP Next Hop IP Address : -> see (15)
  RIP Metric : 3 -> see (16)
  Rip Port Number : 520 -> see (17)
  RIPng Metric : 1 -> see (18)
  RIPng Port Number : 521 -> see (19)
<server1>
  IP Address : 10.1.0.1 -> see (1)
  NIC Alias Name : eth0 -> see (2)
  Destination IP Address : 10.0.0.255 -> see (3)
  Source IP Address : 10.0.0.1 -> see (4)
  Send Interval : 5 -> see (5)
  Routing Protocol : RIPver2 -> see (6)
<server2>
  IP Address : 10.1.0.2 -> see (1)
  NIC Alias Name : eth0 -> see (2)
  Destination IP Address : 10.0.0.255 -> see (3)
  Source IP Address : 10.0.0.2 -> see (4)
  Send Interval : 5 -> see (5)

```

---

Routing Protocol : RIPver2 -> see (6)

=====

**Explanation of each item**

- |                                 |                                           |
|---------------------------------|-------------------------------------------|
| (1) IP Address                  | : IP address                              |
| (2) NIC Alias Name              | : NIC alias name                          |
| (3) Destination IP Address      | : Destination IP address                  |
| (4) Source IP Address           | : Source IP address                       |
| (5) Send Interval               | : Send interval                           |
| (6) Routing Protocol            | : Routing protocol                        |
| (7) Ping Timeout (sec)          | : Ping timeout (sec)                      |
| (8) Ping Retry Count            | : Ping retry count                        |
| (9) Ping Interval (sec)         | : Ping interval (sec)                     |
| (10) VIP Force Activation       | : VIP force activation                    |
| (11) ARP Send Count             | : ARP send count                          |
| (12) Ifconfig Timeout (sec)     | : Ifconfig timeout (in seconds)           |
| (13) Ifconfig Status at Failure | : Operation at Ifconfig failure           |
| • Failure                       | Operates as an activation failure         |
| • Not Failure                   | Does not operate as an activation failure |
| (14) Ping Status at Failure     | : Operation at ping failure               |
| • Failure                       | Operates as an activation failure         |
| • Not Failure                   | Does not operate as an activation failure |
| (15) RIP Next Hop IP Address    | : RIP next hop IP address                 |
| (16) RIP Metric                 | : RIP metric                              |
| (17) RIP Port Number            | : RIP port number                         |
| (18) RIPng Metric               | : RIPng metric                            |
| (19) RIPng Port Number          | : RIPng port number                       |

## ◆ Tips

By using the `--grp` option and the `--rsc` option together, you can display the information as follows.

Command Line # `clpstat --grp --rsc`

```
===== CLUSTER INFORMATION =====
[Group0 : failover1]
  Comment                : failover group1
  [Resource0 : disk1]
    Type                  : disk
    Comment                : /dev/sdb5
    Device Name           : /dev/sdb5
    File System            : ext2
    Mount Point           : /mnt/sdb5
  [Resource1 : execl]
    Type                  : exec
    Comment                : exec resource1
    Start Script
      Path                 : /opt/userpp/start1.sh
    Stop Script
      Path                 : /opt/userpp/stop1.sh
  [Resource2 : fip1]
    Type                  : fip
    Comment                : 10.0.0.11
    IP Address             : 10.0.0.11
[Group1 : failover2]
  Comment                : failover group2
  [Resource0 : disk2]
    Type                  : disk
    Comment                : /dev/sdb6
    Device Name           : /dev/sdb6
    File System            : ext2
    Mount Point           : /mnt/sdb6
  [Resource1 : exec2]
    Type                  : exec
    Comment                : exec resource2
    Start Script
      Path                 : /opt/userpp/start2.sh
    Stop Script
      Path                 : /opt/userpp/stop2.sh
  [Resource2 : fip2]
    Type                  : fip
    Comment                : 10.0.0.12
    IP Address             : 10.0.0.12
=====
```

**Example of a command entry (For volume manager resource)**

```
# clpstat --rsc volmgr --detail
```

**Example of the display after running the command:**

```
===== CLUSTER INFORMATION =====
[Resource2 : volmgr1]
  Type                : volmgr
  Comment              :
  Failover Threshold  : 1
  Retry Count at Activation Failure : 0
  Final Action at Activation Failure : No Operation
                                (Next Resources Are Not Activated)
  Execute Script before Final Action : Off
  Retry Count at Deactivation Failure : 1
  Final Action at Deactivation Failure : Stop Cluster Service
                                And OS Shutdown
  Execute Script before Final Action : Off
  Depended Resources  : ddns
  Volume Manager      : LVM (1)
  Target              : voll1 (2)
  Import Timeout (sec) : 300 (3)
  Start Volume Timeout (sec) : 60 (4)
  Clear Host ID       : On (5)
  Force Import        : On (6)
  Export Timeout (sec) : 300 (7)
  Flush Timeout (sec) : 60 (8)
  Stop Volume Timeout (sec) : 60 (9)
  Force Export        : On (10)
  Check Volume Status Timeout of Activating (sec) : 60 (11)
  Check Volume Status Timeout of Deactivating (sec) : 60 (12)
=====
```

**Explanation of each item**

- |                                                               |                                               |
|---------------------------------------------------------------|-----------------------------------------------|
| <b>(1)</b> Volume Manager                                     | : Volume Manager                              |
| <b>(2)</b> Target                                             | : Target name                                 |
| <b>(3)</b> Import Timeout (sec)                               | : Import timeout                              |
| <b>(4)</b> Start Volume Timeout (sec)                         | : Start volume timeout                        |
| <b>(5)</b> Clear Host ID                                      | : Clear host ID                               |
| <b>(6)</b> Force Import                                       | : Force Import                                |
| <b>(7)</b> Export Timeout (sec)                               | : Export Timeout                              |
| <b>(8)</b> Flush Timeout (sec)                                | : Flush Timeout                               |
| <b>(9)</b> Stop Volume Timeout (sec)                          | : Stop volume timeout                         |
| <b>(10)</b> Force Export                                      | : Force export                                |
| <b>(11)</b> Check Volume Status Timeout of Activating (sec)   | : Check volume status timeout of activating   |
| <b>(12)</b> Check Volume Status Timeout of Deactivating (sec) | : Check volume status timeout of deactivating |

**Example of a command entry (For VM resource)**

**# clpstat --rsc vml --detail**

**Example of the display after running the command:**

```

===== CLUSTER INFORMATION =====
[Resource0 : vml]
Type : vm
Comment :
Failover Threshold : 1
Retry Count at Activation Failure : 0
Final Action at Activation Failure : No Operation
                                     (Next Resources Are Not Activated)
Execute Script before Final Action : Off
Retry Count at Deactivation Failure : 0
Final Action at Deactivation Failure : No Operation
                                     (Next Resources Are Not Activated)
Execute Script before Final Action : Off
Depended Resources :
VM Type : KVM (1)
VM Name : kvm-17net-gos1 (2)
UUID : 6b3e3895-db9b-
      6b82-ec94-2240c232e271 (3)
VM path : (4)
Library Path : /usr/lib64/
              libvirt.so.0.6.3 (5)
vCenter : (6)
Resource pool name : (7)
Timeout Of Request : 30 (8)
Timeout Of Start : 0 (9)
Timeout Of Stop : 240 (10)
=====

```

**Explanation of each item**

- (1)** VM Type : Type of virtual machine
- (2)** VM Name : Name of virtual machine
- (3)** UUID : UUID(Universally Unique Identifier)
- (4)** VM path : Virtual machine path
- (5)** Library Path : Library path
- (6)** vCenter : Host name of vCenter
- (7)** Resource pool name : Resource pool name
- (8)** Timeout Of Request : Request timeout
- (9)** Timeout Of Start : Wait time to start virtual machine
- (10)** Timeout Of Stop : Wait time to stop virtual machine

**Example of a command entry (For Dynamic DNS resource)**

```
# clpstat --rsc ddns1 --detail
```

**Example of the display after running the command:**

```
===== CLUSTER INFORMATION =====
[Resource1 : ddns1]
Type                : ddns
Comment             :
Failover Threshold  : 1
Retry Count at Activation Failure : 1
Final Action at Activation Failure : No Operation
                                (Next Resources Are Not Activated)
Execute Script before Final Action : Off
Retry Count at Deactivation Failure : 1
Final Action at Deactivation Failure : Stop Cluster Service
                                And OS Shutdown
Execute Script before Final Action : Off
Depended Resources  :
DNS Server          : 10.0.0.10 (1)
Port Number         : 53 (2)
Virtual Host Name   : xxx.example.com (3)
IP Address          : 10.0.0.1 (4)
=====
```

**Explanation of each item**

- |                              |                                  |
|------------------------------|----------------------------------|
| <b>(1)</b> DNS Server        | : IP address of DDNS Server      |
| <b>(2)</b> Port Number       | : Port number of the DDNS server |
| <b>(3)</b> Virtual Host Name | : Virtual host name              |
| <b>(4)</b> IP Address        | : IP address                     |

**Example of a command entry (for AWS elastic ip resources)**

**# clpstat --rsc awseip1 --detail**

**Example of the display after running the command:**

```
===== CLUSTER INFORMATION =====
[Resource1 : awseip1]
Type : awseip
Comment :
Failover Threshold : 1
Retry Count at Activation Failure : 1
Final Action at Activation Failure : No Operation
                                     (Next Resources Are Not Activated)
Execute Script before Final Action : Off
Retry Count at Deactivation Failure : 1
Final Action at Deactivation Failure : Stop Cluster Service
                                     And OS Shutdown
Execute Script before Final Action : Off
Depended Resources :
EIP ALLOCATION ID : eipalloc-00000000 (1)
ENI ID : eni-00000000 (2)
AWS CLI Timeout (sec) : 60 (3)
=====
```

**Explanation of each item**

- (1) EIP ALLOCATION ID : ID of the EIP to replace
- (2) ENI ID : ENI ID to which to allocate the EIP
- (3) AWS CLI Timeout (sec) : AWS CLI command timeout



**Example of a command entry (for AWS virtual ip resources)**

```
# clpstat --rsc awsvip1 --detail
```

**Example of the display after running the command:**

```
===== CLUSTER INFORMATION =====
[Resource1 : awsvip1]
Type                : awsvip
Comment             :
Failover Threshold  : 1
Retry Count at Activation Failure : 1
Final Action at Activation Failure : No Operation
                                (Next Resources Are Not Activated)
Execute Script before Final Action : Off
Retry Count at Deactivation Failure : 1
Final Action at Deactivation Failure : Stop Cluster Service
                                And OS Shutdown
Execute Script before Final Action : Off
Depended Resources  :
IP Address          : 1.1.1.1           (1)
VPC ID              : vpc-00000000     (2)
ENI ID              : eni-00000000     (3)
AWS CLI Timeout (sec) : 60             (4)
=====
```

**Explanation of each item**

- |                                  |                                                 |
|----------------------------------|-------------------------------------------------|
| <b>(1)</b> IP Address            | : VIP address to use                            |
| <b>(2)</b> VPC ID                | : VPC ID to which the server belongs            |
| <b>(3)</b> ENI ID                | : ENI ID of the routing destination of the IVIP |
| <b>(4)</b> AWS CLI Timeout (sec) | : AWS CLI command timeout                       |

**Example of a command entry (for Azure probe port resources)**

**# clpstat --rsc azurepp1 --detail**

**Example of the display after running the command:**

```
===== CLUSTER INFORMATION =====
[Resource1 : azurepp1]
Type : azurepp
Comment :
Failover Threshold : 1
Retry Count at Activation Failure : 1
Final Action at Activation Failure : No Operation
                                     (Next Resources Are Not Activated)
Execute Script before Final Action : Off
Retry Count at Deactivation Failure : 1
Final Action at Deactivation Failure : Stop Cluster Service
                                     And OS Shutdown
Execute Script before Final Action : Off
Depended Resources :
Probe Port : 8080 (1)
Probe Timeout (sec) : 30 (2)
=====
```

**Explanation of each item**

- (1)** Probe Port : Probe port
- (2)** Probe Timeout (sec): : Probe wait timeout

## Displaying only the configuration data of a certain monitor resource (--mon option)

When you want to display only the cluster configuration data on a specified monitor resource, specify the name of the monitor resource after the `--mon` option in the `clpstat` command. If you want to see the details, specify `--detail` option. When you do not specify the name of monitor resource, the cluster configuration data of all monitor resources is displayed.

### Example of a command entry (For disk monitor resource)

```
# clpstat --mon diskw1 --detail
```

### Example of the display after running the command:

```
===== CLUSTER INFORMATION =====
[Monitor0 : diskw1] (1)
Type : diskw (2)
Comment : disk monitor1 (3)
Monitor Timing : Always (4)
Target Resource : (5)
Interval(sec) : 60 (6)
Timeout (sec) : 120 (7)
Retry Count : 0 (8)
Final Action : No Operation (9)
Execute Script before Reactivation: Off (10)
Execute Script before Failover : Off (11)
Execute Script before Final Action: Off (12)
Recovery Target : disk1 (13)
Recovery Target Type : Resource (14)
Recovery script Threshold : 0 (15)
Reactivation Threshold : 3 (16)
Failover Threshold : 1 (17)
Wait Time to Start Monitoring (sec): 0 (18)
Nice Value : 0 (19)
Monitor Suspend Possibility : Possible (20)
Gather Dump When Timeout : Off (21)
Execute Migration Before Failover: Off (22)
Dummy Failure Possibility : Off (23)
Method : READ(O_DIRECT) (24)
Monitor Target : /dev/sdb5 (25)
Target RAW Device Name : (26)
I/O Size (byte) : 512 (27)
=====
```

- ◆ The items written in the 1<sup>st</sup> to the 15<sup>th</sup> line are common to all monitor resources.
- ◆ The items described in the 4<sup>th</sup> to the 15<sup>th</sup> line are displayed when the `--detail` option is used.

### Explanation of items common to each monitor resource

- (1) [MONITOR n: *monitor\_resource\_name*]  
(n is the identification number of the group)
- (2) Type : Monitor resource type
- (3) Comment : Comment
- (4) Monitor Timing : Timing to start monitoring
  - Always : Always monitors

- Activating : Monitors while activated
- (5) Target Resource : Monitor target resource
- (6) Interval (sec) : Monitor interval (in seconds)
- (7) Timeout (sec) : Monitor time-out (in seconds)
- (8) Retry Count : Monitor retry count
- (9) Final Action : Final action
  - No Operation : No action is taken
  - Stop Resource : The resource is stopped
  - Stop Group : The group is stopped
  - Stop the cluster daemon : The cluster daemon will be stopped
  - Stop the cluster daemon and shut down OS : The cluster daemon will be stopped and the OS will be shut down
  - Stop the cluster daemon and reboot OS : The cluster daemon will be stopped and the OS will be restarted.
  - Sysrq Panic : The panic of sysrq is performed.
  - Keepalive Reset : The server is reset by using the clpkhb or clpka driver.
  - Keepalive Panic : The server panic is performed by using the clpkhb or clpka driver.
  - BMC Reset : The server is reset by using the ipmi command.
  - BMC Power Off : The server is powered off by using the ipmi command.
  - BMC Power Cycle : The server power cycle (power on/off) is performed by using the ipmi command.
  - BMC NMI : NMI is generated by using the ipmi
  - I/O Fencing(High-End Server Option) : The I/O Fencing using ACPI and NMI are generated.
- (10) Execute Script before Reactivation : Execute script before reactivation
- (11) Execute Script before Failover : Execute script before failover
- (12) Execute Script before Final Action : Execute script before final action
- (13) Recovery Target : Target to be recovered when an error is detected
- (14) Recovery Target Type : Type of a target to be recovered when an error is detected
- (15) Recovery script Threshold : Recovery script execution count
- (16) Reactivation Threshold : Restart count
- (17) Failover Threshold : Failover count
- (18) Wait Time to Start Monitoring (sec) : Time to wait for the start of monitoring (in seconds)
- (19) Nice Value : Nice value
- (20) Monitor Suspend Possibility : Possibility of suspending monitoring
  - Possible : Suspending monitoring is possible
  - Impossible : Suspending monitoring is not possible
- (21)Gather Dump When Timeout : Gather dump when timeout occurs
  - On : Gather
  - Off : Do not gather
- (22)Excite Migration Before Failover : Execute migration before failover

- On : Execute
- Off : Do not execute

(23) Dummy Failure Possibility : Possibility of dummy failure

- Possible : Dummy failure is possible
- Impossible : Dummy failure is not possible

#### Explanation of each item

(24) Method : Monitor method

- TUR  
For details, see "Understanding the disk monitor resources" in Chapter 5, "Monitor resource details" in this *Reference Guide*.
- TUR(legacy)  
For details, see "Understanding the disk monitor resources" in Chapter 5, "Monitor resource details" in this *Reference Guide*.
- TUR(generic)  
For details, see "Understanding the disk monitor resources" in Chapter 5, "Monitor resource details" in this *Reference Guide*.
- READ  
For details, see "Understanding the disk monitor resources" in Chapter 5, "Monitor resource details" in this *Reference Guide*.
- READ(O\_DIRECT)  
For details, see "Understanding the disk monitor resources" in Chapter 5, "Monitor resource details" in this *Reference Guide*.
- READ(RAW)  
For details, see "Understanding the disk monitor resources" in Chapter 5, "Monitor resource details" in this *Reference Guide*.
- READ(VXVM)  
For details, see "Understanding the disk monitor resources" in Chapter 5, "Monitor resource details" in this *Reference Guide*.
- WRITE(FILE)  
For details, see "Understanding the disk monitor resources" in Chapter 5, "Monitor resource details" in this *Reference Guide*.

(25) Monitor Target : Monitor target

(26) Target RAW Device Name : Name of monitor target RAW device

(27) I/O size (byte) : Monitoring I/O size (in bytes)

\* Monitoring I/O size is effective when the monitoring method is "READ."

**Example of a command entry (For IP monitor resource)**

**# clpstat --mon ipw1 --detail**

**Example of the display after running the command:**

```

===== CLUSTER INFORMATION =====
[Monitor2 : ipw1]
Type : ipw
Comment : ip monitor1
Monitor Timing : Always
Target Resource :
Interval(sec) : 30
Timeout (sec) : 10
Retry Count : 0
Final Action : No Operation
Execute Script before Reactivation: Off
Execute Script before Failover : Off
Execute Script before Final Action: Off
Recovery Target : cluster
Recovery Target Type : Itself
Recovery script Threshold : 0
Reactivation Threshold : 0
Failover Threshold : 0
Wait Time to Start Monitoring (sec): 0
Nice Value : 0
Monitor Suspend Possibility : Possible
Gather Dump When Timeout : Off
Execute Migration Before Failover: Off
Dummy Failure Possibility : Possible
IP Addresses : 192.168.15.254 (1)
=====

```

**Explanation of each item**

(1) IP Addresses : IP address of the monitor target

**Example of a command entry (For PID monitor resource)**

```
# clpstat --mon pidw1 --detail
```

**Example of the display after running the command:**

```
===== CLUSTER INFORMATION =====
[Monitor3 : pidw1]
Type : pidw
Comment : pidw1
Monitor Timing : Activating
Target Resource : execl
Interval(sec) : 5
Timeout (sec) : 60
Retry Count : 0
Final Action : No Operation
Execute Script before Reactivation: Off
Execute Script before Failover : Off
Execute Script before Final Action: Off
Recovery Target : execl
Recovery Target Type : Resource
Recovery script Threshold : 0
Reactivation Threshold : 3
Failover Threshold : 1
Wait Time to Start Monitoring (sec): 0
Nice Value : 0
Monitor Suspend Possibility : Possible
Gather Dump When Timeout : Off
Execute Migration Before Failover: Off
Dummy Failure Possibility : Possible
Target PID : 1197 (1)
=====
```

**Explanation of each item**

(1) Target PID : Monitor target PID

**Example of a command entry (Mirror disk monitor resource: when Replicator is used)****# clpstat --mon mdw1 --detail****Example of the display after running the command:**

```

===== CLUSTER INFORMATION =====
[Monitor4 : mdw1]
  Type                : mdw
  Comment              : mirror disk monitor
  Monitor Timing      : Always
  Target Resource     :
  Interval(sec)       : 10
  Timeout (sec)       : 60
  Retry Count         : 0
  Final Action        : No Operation
  Execute Script before Reactivation: Off
  Execute Script before Failover : Off
  Execute Script before Final Action: Off
  Recovery Target     : cluster
  Recovery Target Type : Itself
  Recovery script Threshold : 0
  Reactivation Threshold : 0
  Failover Threshold  : 0
  Wait Time to Start Monitoring (sec): 0
  Nice Value          : 0
  Monitor Suspend Possibility : Possible
  Gather Dump When Timeout : Off
  Execute Migration Before Failover: Off
  Dummy Failure Possibility : Impossible
  Monitor Target      : mdl (1)
=====

```

**Explanation of each item**

(1) Monitor Target : Monitor target resource



**Example of a command entry (Mirror disk monitor resource: when Replicator is used)**

```
# clpstat --mon mdnw1 --detail
```

**Example of the display after running the command:**

```
===== CLUSTER INFORMATION =====
[Monitor5 : mdnw1]
  Type                : mdnw
  Comment              : mirror disk connect monitor
  Monitor Timing      : Always
  Target Resource     :
  Interval(sec)       : 60
  Timeout (sec)       : 120
  Retry Count         : 0
  Final Action        : No Operation
  Execute Script before Reactivation: Off
  Execute Script before Failover : Off
  Execute Script before Final Action: Off
  Recovery Target     : cluster
  Recovery Target Type : Itself
  Recovery script Threshold : 0
  Reactivation Threshold : 0
  Failover Threshold  : 0
  Wait Time to Start Monitoring (sec): 0
  Nice Value          : 0
  Monitor Suspend Possibility : Possible
  Gather Dump When Timeout : Off
  Execute Migration Before Failover: Off
  Dummy Failure Possibility : Impossible
  Monitor Target      : md1 (1)
```

**Explanation of each item**

(1) Monitor Target : Monitor target mirror disk resource

**Example of a command entry (Hybrid disk monitor resource: when Replicator DR is used)****# clpstat --mon hdw1 -detail****Example of the display after running the command:**

```

===== CLUSTER INFORMATION =====
[Monitor4 : hdw1]
  Type                : hdw
  Comment              : hybrid disk monitor
  Monitor Timing      : Always
  Target Resource     :
  Interval(sec)       : 10
  Timeout (sec)       : 60
  Retry Count         : 0
  Final Action        : No Operation
  Execute Script before Reactivation: Off
  Execute Script before Failover : Off
  Execute Script before Final Action: Off
  Recovery Target     : cluster
  Recovery Target Type : Itself
  Recovery script Threshold : 0
  Reactivation Threshold : 0
  Failover Threshold  : 0
  Wait Time to Start Monitoring (sec): 0
  Nice Value          : 0
  Monitor Suspend Possibility : Possible
  Gather-Dump-When-Timeout : Off
  Execute Migration Before Failover: Off
  Dummy Failure Possibility : Impossible
  Monitor Target      : hdl (1)
=====

```

**Explanation of each item**

(1) Monitor Target : Monitor target resource

**Example of a command entry (Hybrid disk monitor resource: when Replicator DR is used)**

```
# clpstat --mon hdnw1 --detail
```

**Example of the display after running the command:**

```
===== CLUSTER INFORMATION =====
[Monitor5 : hdnw1]
Type : hdnw
Comment : hybrid disk connect monitor
Monitor Timing : Always
Target Resource :
Interval(sec) : 60
Timeout (sec) : 120
Retry Count : 0
Final Action : No Operation
Execute Script before Reactivation: Off
Execute Script before Failover : Off
Execute Script before Final Action: Off
Recovery Target : cluster
Recovery Target Type : Itself
Recovery script Threshold : 0
Reactivation Threshold : 0
Failover Threshold : 0
Wait Time to Start Monitoring (sec): 0
Nice Value : 0
Monitor Suspend Possibility : Possible
Gather Dump When Timeout : Off
Execute Migration Before Failover: Off
Dummy Failure Possibility : Impossible
Monitor Target : hdl (1)
=====
```

**Explanation of each item**

(1) Monitor Target : Monitor target resource

**Example of a command entry (For user-mode monitor resource)**

**# clpstat --mon userw --detail**

**Example of the display after running the command:**

```

===== CLUSTER INFORMATION =====
[Monitor6 : userw]
Type : userw
Comment : usermode monitor
Monitor Timing : Always
Target Resource :
Interval(sec) : 3
Timeout (sec) : 90
Retry Count : 0
Final Action :
Execute Script before Reactivation: Off
Execute Script before Failover : Off
Execute Script before Final Action: Off
Recovery Target : cluster
Recovery Target Type : Itself
Recovery script Threshold : 0
Reactivation Threshold : 0
Failover Threshold : 0
Wait Time to Start Monitoring (sec): 0
Nice Value : -20
Monitor Suspend Possibility : Possible
Gather Dump When Timeout : Off
Execute Migration Before Failover: Off
Dummy Failure Possibility : Impossible
Method : softdog (1)
Action : RESET (2)
Use HB interval and timeout : On (3)
Open/Close Temporary File : On (4)
with Writing : On (5)
Size (byte) : 10000 (6)
Create Temporary Thread : On (7)
=====

```

**Explanation of each item**

- (1) Method : Monitor method
- (2) Action : Final action at timeout
- (3) Use HB interval and timeout : Use HB interval and timeout
- (4) Open/Close Temporary File : Open/Close temporary file
- (5) with Writing : Write data into a temporary file
- (6) Size (byte) : Size of the data to be written into a temporary file (in bytes)
- (7) Create Temporary Thread : Create temporary thread

**Example of a command entry (For NIC LINK Up/Down monitor resource)**

```
# clpstat --mon miwl --detail
```

**Example of the display after running the command:**

```
===== CLUSTER INFORMATION =====
[Monitor10 : miwl]
Type : miw
Comment : NIC Link Up/Down monitor
Monitor Timing : Always
Target Resource :
Interval(sec) : 10
Timeout (sec) : 60
Retry Count : 0
Final Action : No Operation
Execute Script before Reactivation: Off
Execute Script before Failover : Off
Execute Script before Final Action: Off
Recovery Target : cluster
Recovery Target Type : Itself
Recovery script Threshold : 0
Reactivation Threshold : 0
Failover Threshold : 1
Wait Time to Start Monitoring (sec): 0
Nice Value : 0
Monitor Suspend Possibility : Possible
Gather Dump when Timeout : Off
Execute Migration Before Failover: Off
Dummy Failure Possibility : Possible
Monitor Target : eth0 (1)
=====
```

**Explanation of each item**

(1) Monitor Target : Monitor target interface name

**Example of a command entry (For multi target monitor resource)****# clpstat --mon mtw1 --detail****Example of the display after running the command:**

```

===== CLUSTER INFORMATION =====
[Monitor11 : mtw1]
Type : mtw
Comment : multi-target monitor
Monitor Timing : Always
Target Resource :
Interval(sec) : 30
Timeout (sec) : 30
Retry Count : 0
Final Action : No Operation
Execute Script before Reactivation: Off
Execute Script before Failover : Off
Execute Script before Final Action: Off
Recovery Target : cluster
Recovery Target Type : Itself
Recovery script Threshold : 0
Reactivation Threshold : 0
Failover Threshold : 0
Wait Time to Start Monitoring (sec): 0
Nice Value : 0
Monitor Suspend Possibility : Possible
Gather Dump When Timeout : Off
Execute Migration Before Failover: Off
Dummy Failure Possibility : Possible
Monitor Resources : diskw1 (1)
                  : ipw3
                  : raww1
=====

```

**Explanation of each item**

(1) Monitor Resources : Monitor resource list

**Example of a command entry (For virtual IP monitor resource)**

```
# clpstat --mon vipw1 --detail
```

**Example of the display after running the command:**

```
===== CLUSTER INFORMATION =====
[Monitor11 : vipw1]
Type : vipw
Comment : vip monitor
Monitor Timing : Activating
Target Resource : vip1
Interval(sec) : 3
Timeout (sec) : 30
Retry Count : 0
Final Action : No Operation
Execute Script before Reactivation: Off
Execute Script before Failover : Off
Execute Script before Final Action: Off
Recovery Target : cluster
Recovery Target Type : Itself
Recovery script Threshold : 0
Reactivation Threshold : 0
Failover Threshold : 0
Wait Time to Start Monitoring (sec): 0
Nice Value : 0
Monitor Suspend Possibility : Impossible
Gather Dump When Timeout : Off
Execute Migration Before Failover: Off
Dummy Failure Possibility : Impossible
Monitor Target : vip1 (1)
=====
```

**Explanation of each item**

(1) Monitor Target : Monitor target resource

**Example of a command entry (For ARP monitor resource)**

```
# clpstat --mon arpw1 --detail
```

**Example of the display after running the command:**

```
===== CLUSTER INFORMATION =====
[Monitor11 : arpw1]
Type : arpw
Comment : arp monitor
Monitor Timing : Activating
Target Resource : fipl
Interval(sec) : 30
Timeout (sec) : 180
Retry Count : 0
Final Action : No Operation
Execute Script before Reactivation: Off
Execute Script before Failover : Off
Execute Script before Final Action: Off
Recovery Target : cluster
Recovery Target Type : Itself
Recovery script Threshold : 0
Reactivation Threshold : 0
Failover Threshold : 0
Wait Time to Start Monitoring (sec): 0
Nice Value : 0
Monitor Suspend Possibility : Impossible
Gather Dump When Timeout : Off
Execute Migration Before Failover: Off
Dummy Failure Possibility : Impossible
Monitor Target : fipl (1)
=====
```

**Explanation of each item**

(1) Monitor Target : Monitor target resource



**Example of a command entry (For custom monitor resource)**

```
# clpstat --mon genw --detail
```

**Example of the display after running the command:**

```
===== CLUSTER INFORMATION =====
[Monitor0 : genw]
Type : genw
Comment :
Monitor Timing : Always
Target Resource :
Interval(sec) : 60
Timeout (sec) : 120
Retry Count : 0
Final Action : No Operation
Execute Script before Reactivation: Off
Execute Script before Failover : Off
Execute Script before Final Action: Off
Recovery Target : exec
Recovery Target Type : Resource
Recovery script Threshold : 0
Reactivation Threshold : 3
Failover Threshold : 1
Wait Time to Start Monitoring (sec): 0
Nice Value : 0
Monitor Suspend Possibility : Possible
Gather Dump When Timeout : Off
Execute Migration Before Failover: Off
Dummy Failure Possibility : Possible
Monitor Path : genw.sh (1)
Monitor Type : Synchronous (2)
Log Output Path : /tmp/log/test.txt (3)
Script Log Rotate : off (4)
Script Log Rotate Size (byte) : 1000000 (5)
Script Log Rotate Generation : 2 (6)
=====
```

**Explanation of each item**

- |                                          |                                            |
|------------------------------------------|--------------------------------------------|
| <b>(1)</b> Monitor Path                  | : Target monitor resource                  |
| <b>(2)</b> Monitor Type                  | : Monitor type                             |
| <b>(3)</b> Log Output Path               | : Location where script log will be output |
| <b>(4)</b> Script Log Rotate             | : Rotate script log                        |
| • On                                     | : Rotate script log                        |
| • Off                                    | : Do not rotate script log                 |
| <b>(5)</b> Script Log Rotate Size (byte) | : Size of script log                       |
| <b>(6)</b> Script Log Rotate Generation  | : Generation number of script log          |

**Example of a command entry (For volume manager monitor resource)**

**# clpstat --mon volmgrw --detail**

**Example of the display after running the command:**

```

===== CLUSTER INFORMATION =====
[Monitor0 : volmgrw]
Type                               : volmgrw
Comment                             :
Monitor Timing                       : Always
Target Resource                       :
Interval(sec)                        : 60
Timeout (sec)                        : 120
Retry Count                          : 1
Final Action                         : No Operation
Execute Script before Reactivation: Off
Execute Script before Failover      : Off
Execute Script before Final Action: Off
Recovery Target                      : exec
Recovery Target Type                 : Resource
Recovery script Threshold            : 0
Reactivation Threshold               : 3
Failover Threshold                   : 1
Wait Time to Start Monitoring (sec): 0
Nice Value                           : 0
Monitor Suspend Possibility          : Possible
Gather Dump When Timeout       : Off
Execute Migration Before Failover: Off
Dummy Failure Possibility             : Possible
Volume Manager                       : lvm
Target                               : voll
=====

```

**Explanation of each item**

- (1)** Volume Manager : Volume manager
- (2)** Target : Device name of the logical disk

**Example of a command entry (For message receive monitor resource)**

```
# clpstat --mon mrw --detail
```

**Example of the display after running the command:**

```
===== CLUSTER INFORMATION =====
[Monitor0 : mrw]
Type : mrw
Comment :
Monitor Timing : Always
Target Resource :
Interval(sec) : 10
Timeout (sec) : 30
Retry Count : 0
Final Action : No Operation
Execute Script before Reactivation: Off
Execute Script before Failover : Off
Execute Script before Final Action: Off
Recovery Target : exec
Recovery Target Type : Resource
Recovery script Threshold : 0
Reactivation Threshold : 3
Failover Threshold : 1
Wait Time to Start Monitoring (sec): 0
Nice Value : 0
Monitor Suspend Possibility : Possible
Gather Dump When Timeout : Off
Execute Migration Before Failover: Off
Dummy Failure Possibility : Impossible
Category : NIC (1)
Keyword : (2)
Execute Failover to outside the Server Group: Off (3)
=====
```

**Explanation of each item**

- (1) Category : Category
- (2) Keyword : Keyword
- (3) Execute Failover to outside the Server Group : Failover to outside the server group
- On : Execute failover
  - Off : Do not execute failover

**Example of a command entry (For VM monitor resource)**

```
# clpstat --mon vmw1 --detail
```

**Example of the display after running the command:**

```
===== CLUSTER INFORMATION =====
[Monitor1 : vmw1]
  Type                : vmw
  Comment             :
  Monitor Timing      : Always
  Target Resource     :
  Interval (sec)      : 10
  Timeout (sec)       : 30
  Retry Count         : 0
  Final Action        : No Operation
  Execute Script before Reactivation: Off
  Execute Script before Failover: Off
  Execute Script before Final Action: Off
  Recovery Target     : vm1
  Recovery Target Type : Resource
  Recovery script Threshold : 0
  Reactivation Threshold : 0
  Failover Threshold  : 0
  Wait Time to Start Monitoring (sec): 0
  Nice Value          : 0
  Monitor Suspend Possibility : Possible
  Gather Dump When Timeout : Off
  Execute Migration Before Failover: Off
  Dummy Failure Possibility : Impossible
  virtual machine resource name: vm1 (1)
```

**Explanation of each item**

(1) Virtual machine resource name : Name of virtual machine resource

**Example of a command entry (For Dynamic DNS monitor resource)**

```
# clpstat --mon ddns1 --detail
```

**Example of the display after running the command:**

```
===== CLUSTER INFORMATION =====
[Monitor0 : ddns1]
Type : ddns1
Comment :
Monitor Timing : Always
Target Resource : ddns1
Interval(sec) : 60
Timeout (sec) : 76
Retry Count : 0
Final Action : No Operation
Execute Script before Reactivation: Off
Execute Script before Failover : Off
Execute Script before Final Action: Off
Recovery Target : ddns1
Recovery Target Type : Resource
Recovery script Threshold : 0
Reactivation Threshold : 3
Failover Threshold : 1
Wait Time to Start Monitoring (sec): 0
Nice Value : 0
Monitor Suspend Possibility : Impossible
Gather Dump When Timeout : Off
Execute Migration Before Failover: Off
Dummy Failure Possibility : Impossible
Monitor Target :
ddns1 (1)
```

**Explanation of each item**

**(1)** Monitor Target : Monitor target

**Example of a command entry (For DB2 monitor resource)**

```
# clpstat --mon db2w1 --detail
```

**Example of the display after running the command:**

```
===== CLUSTER INFORMATION =====
[Monitor11 : db2w1]
Type                : db2w
Comment             : DB2 monitor
Monitor Timing      : Activating
Target Resource     : execl
Interval(sec)       : 60
Timeout (sec)       : 120
Retry Count         : 0
Final Action        : Stop Cluster Daemon And
                    OS Shutdown

Execute Script before Reactivation: Off
Execute Script before Failover : Off
Execute Script before Final Action: Off
Recovery Target     : execl
Recovery Target Type : Resource
Recovery script Threshold : 0
Reactivation Threshold : 0
Failover Threshold  : 1
Wait Time to Start Monitoring (sec): 0
Nice Value          : 0
Monitor Suspend Possibility : Possible
Gather Dump When Timeout : Off
Execute Migration Before Failover: Off
Dummy Failure Possibility : Possible
Database Name        : test (1)
Instance            : db2inst1 (2)
Table               : db2watch (3)
Character Set        : ja_JP.euc.JP (4)
Library Path        : (5)
                    /opt/ibm/db2/V9.1/lib64/libdb2.so
Monitor Action      : Level 2 (monitoring by update/select) (6)
=====
```

**Explanation of each item**

- |                    |                                                        |
|--------------------|--------------------------------------------------------|
| (1) Database Name  | : Name of the monitor target database                  |
| (2) Instance       | : Instance of the monitor target database              |
| (3) Table          | : Name of the monitor target table created on database |
| (4) Character Set  | : Character set of DB2                                 |
| (5) Library Path   | : Library path of DB2                                  |
| (6) Monitor Action | : Monitor level                                        |

**Example of a command entry (For FTP monitor resource)**

```
# clpstat --mon ftpw1 --detail
```

**Example of the display after running the command:**

```
===== CLUSTER INFORMATION =====
[Monitor11 : ftpw1]
Type : ftpw
Comment : ftp monitor
Monitor Timing : Activating
Target Resource : execl
Interval(sec) : 60
Timeout (sec) : 120
Retry Count : 0
Final Action : Stop Cluster Daemon And
              OS Shutdown

Execute Script before Reactivation: Off
Execute Script before Failover : Off
Execute Script before Final Action: Off
Recovery Target : execl
Recovery Target Type : Resource
Recovery script Threshold : 0
Reactivation Threshold : 0
Failover Threshold : 1
Wait Time to Start Monitoring (sec): 0
Nice Value : 0
Monitor Suspend Possibility : Possible
Gather Dump When Timeout : Off
Execute Migration Before Failover: Off
Dummy Failure Possibility : Possible
IP Address : 127.0.0.1 (1)
Port : 21 (2)
=====
```

**Explanation of each item**

- (1) IP Address : IP address of the monitor target  
 (2) Port : Port number

**Example of a command entry (For HTTP monitor resource)**

```
# c1pstat --mon httpw1 --detail
```

**Example of the display after running the command:**

```
===== CLUSTER INFORMATION =====
[Monitor11 : httpw1]
Type : httpw
Comment : http monitor
Monitor Timing : Activating
Target Resource : execl
Interval(sec) : 60
Timeout (sec) : 120
Retry Count : 0
Final Action : Stop Cluster Daemon And
              OS Shutdown

Execute Script before Reactivation: Off
Execute Script before Failover : Off
Execute Script before Final Action: Off
Recovery Target : execl
Recovery Target Type : Resource
Recovery script Threshold : 0
Reactivation Threshold : 0
Failover Threshold : 1
Wait Time to Start Monitoring (sec): 0
Nice Value : 0
Monitor Suspend Possibility : Possible
Gather Dump When Timeout : Off
Execute Migration Before Failover: Off
Dummy Failure Possibility : Possible
Connecting Destination : localhost (1)
Port : 80 (2)
Request URI : (3)
Protocol : 0 (4)
=====
```

**Explanation of each item**

- |                                   |                                              |
|-----------------------------------|----------------------------------------------|
| <b>(1)</b> Connecting Destination | : Internet server name of the monitor target |
| <b>(2)</b> Port                   | : Port number of the Internet server         |
| <b>(3)</b> Request URI            | : Request URI                                |
| <b>(4)</b> Protocol               | : Protocol used for monitoring               |
- 0  
  HTTP
  - 1  
  HTTPS



**Example of a command entry (For imap4 monitor resource)**

```
# clpstat --mon imap4w1 --detail
```

**Example of the display after running the command:**

```
===== CLUSTER INFORMATION =====
[Monitor11 : imap4w1]
  Type                : imap4w
  Comment             : imap4  monitor
  Monitor Timing      : Activating
  Target Resource     : execl
  Interval(sec)       : 60
  Timeout (sec)       : 120
  Retry Count         : 0
  Final Action        : Stop Cluster Daemon And
                      OS Shutdown

  Execute Script before Reactivation: Off
  Execute Script before Failover   : Off
  Execute Script before Final Action: Off
  Recovery Target                   : execl
  Recovery Target Type               : Resource
  Recovery script Threshold          : 0
  Reactivation Threshold             : 0
  Failover Threshold                 : 1
  Wait Time to Start Monitoring (sec): 0
  Nice Value                         : 0
  Monitor Suspend Possibility        : Possible
Gather Dump When Timeout      : Off
  Execute Migration Before Failover: Off
  Dummy Failure Possibility          : Possible
  IP Address                        : 127.0.0.1          (1)
  Port                              : 143                  (2)
  Authority Method                   : AUTHENTICATE LOGIN  (3)
=====
```

**Explanation of each item**

- (1) IP Address : IP address of the monitor target
- (2) Port : Port number of imap4
- (3) Authority Method : Authority method of imap4

**Example of a command entry (For MySQL monitor resource)**

```
# clpstat --mon mysqlw1 --detail
```

**Example of the display after running the command:**

```
===== CLUSTER INFORMATION =====
[Monitor11 : mysqlw1]
Type                               : mysqlw
Comment                            : MySQL monitor
Monitor Timing                     : Activating
Target Resource                    : execl
Interval(sec)                      : 60
Timeout (sec)                      : 120
Retry Count                        : 0
Final Action                       : Stop Cluster Daemon And
                                   OS Shutdown

Execute Script before Reactivation: Off
Execute Script before Failover    : Off
Execute Script before Final Action: Off
Recovery Target                   : execl
Recovery Target Type              : Resource
Recovery script Threshold         : 0
Reactivation Threshold            : 0
Failover Threshold                : 1
Wait Time to Start Monitoring (sec): 0
Nice Value                        : 0
Monitor Suspend Possibility       : Possible
Gather Dump When Timeout    : Off
Execute Migration Before Failover: Off
Dummy Failure Possibility         : Possible
Database Name                     : test (1)
IP Address                        : 127.0.0.1 (2)
Port                              : 3306 (3)
Table                             : mysqlwatch (4)
Storage Engine                    : MyISAM (5)
Library Path                      :
                                   /usr/lib64/libmysqlclient.so.15 (6)
Monitor Action                    : Level 2 (monitoring by update/select) (7)
=====
```

**Explanation of each item**

- |                    |                                                        |
|--------------------|--------------------------------------------------------|
| (1) Database Name  | : Name of the monitor target database                  |
| (2) IP Address     | : IP address to connect to MySQL server                |
| (3) Port           | : Port number of MySQL                                 |
| (4) Table          | : Name of the table for monitoring created on database |
| (5) Storage Engine | : Storage engine of MySQL                              |
| (6) Library Path   | : Library path of MySQL                                |
| (7) Monitor Action | : Monitor level                                        |

**Example of a command entry (For nfs monitor resource)**

```
# clpstat --mon nfsw1 --detail
```

**Example of the display after running the command:**

```
===== CLUSTER INFORMATION =====
[Monitor11 : nfsw1]
  Type                : nfsw
  Comment             : nfs monitor
  Monitor Timing      : Activating
  Target Resource     : execl
  Interval(sec)       : 60
  Timeout (sec)       : 120
  Retry Count         : 0
  Final Action        : Stop Cluster Daemon And
                      OS Shutdown

  Execute Script before Reactivation: Off
  Execute Script before Failover   : Off
  Execute Script before Final Action: Off
  Recovery Target                   : execl
  Recovery Target Type               : Resource
  Recovery script Threshold          : 0
  Reactivation Threshold             : 0
  Failover Threshold                 : 1
  Wait Time to Start Monitoring (sec): 0
  Nice Value                         : 0
  Monitor Suspend Possibility        : Possible
Gather Dump When Timeout       : Off
  Execute Migration Before Failover: Off
  Dummy Failure Possibility          : Possible
  Shared Directory                   : /mnt/nfsmon           (1)
  IP Address                         : 127.0.0.1           (2)
=====
```

**Explanation of each item**

- (1) Shared Directory : Shared name that NFS server exports  
 (2) IP Address : IP address to connect to NFS server

**Example of a command entry (For Oracle monitor resource)**

```
# clpstat --mon oraclew1 --detail
```

**Example of the display after running the command:**

```
===== CLUSTER INFORMATION =====
[Monitor11 : oraclew1]
  Type                : oraclew
  Comment             : Oracle monitor
  Monitor Timing      : Activating
  Target Resource     : execl
  Interval(sec)       : 60
  Timeout (sec)       : 120
  Retry Count         : 0
  Final Action        : Stop Cluster Daemon And
                      OS Shutdown

  Execute Script before Reactivation: Off
  Execute Script before Failover   : Off
  Execute Script before Final Action: Off
  Recovery Target                  : execl
  Recovery Target Type              : Resource
  Recovery script Threshold         : 0
  Reactivation Threshold            : 0
  Failover Threshold                : 1
  Wait Time to Start Monitoring (sec): 0
  Nice Value                        : 0
  Monitor Suspend Possibility       : Possible
  Gather Dump When Timeout          : Off
  Execute Migration Before Failover: Off
  Dummy Failure Possibility         : Possible
  Connect Command                   : orcl (1)
  Authority                         : SYSDBA (2)
  Table                             : orawatch (3)
  Character Set                     : JAPANESE_JAPAN.JA16EUC (4)
  Library Path                      :
  /opt/oracle/product/1.0.0.1/lib/libclntsh.so.10.1 (5)
  Monitor Method                    : listner and instance monitor (6)
  Monitor Action                    :
  Level 2 (monitoring by update/select) (7)
  ORACLE_HOME                      : /opt/oracle/product/1.0.0.1/ (8)
=====
```

**Explanation of each item**

- (1) Connect Command : Connection character corresponding to database to be monitored
- (2) Authority : Authority for accessing database
- SYSDBA  
Accesses database using SYSDBA authority by using a specified user name
  - DEFAULT  
Accesses database by using a specified user name
- (3) Table : Name of the table for monitoring created on database
- (4) Character Set : Character set of Oracle
- (5) Library Path : Library path of Oracle
- (6) Monitor Method : Method for monitoring Oracle
- (7) Monitor Action : Monitor level
- (8) ORACLE\_HOME : ORACLE\_HOME path

**Example of a command entry (For OracleAS monitor resource)**

```
# clpstat mon --oracleasw1 --detail
```

**Example of the display after running the command:**

```
===== CLUSTER INFORMATION =====
[Monitor11 : oracleasw1]
Type : oracleasw
Comment : OracleAS monitor
Monitor Timing : Activating
Target Resource : execl
Interval(sec) : 60
Timeout (sec) : 120
Retry Count : 0
Final Action : Stop Cluster Daemon And
              OS Shutdown

Execute Script before Reactivation: Off
Execute Script before Failover : Off
Execute Script before Final Action: Off
Recovery Target : execl
Recovery Target Type : Resource
Recovery script Threshold : 0
Reactivation Threshold : 0
Failover Threshold : 1
Wait Time to Start Monitoring (sec): 0
Nice Value : 0
Monitor Suspend Possibility : Possible
Gather Dump When Timeout : Off
Execute Migration Before Failover: Off
Dummy Failure Possibility : Possible
Instance : orcl (1)
Install Path : (2)
  /home/ias/product/10.1.3.2/companionCDHome_1
Monitor Method : 2 (3)
Component List : (4)
=====
```

**Explanation of each item**

- (1) Instance : Name of instance for connecting the application
- (2) Install Path : Install path of OracleAS
- (3) Monitor Method : Method for monitoring OracleAS
- (4) Component List : Name of target component

**Example of a command entry (For pop3 monitor resource)**

**# clpstat --mon pop3w1 --detail**

**Example of the display after running the command:**

```

===== CLUSTER INFORMATION =====
[Monitor11 : pop3w1]
Type : pop3w
Comment : pop3_monitor
Monitor Timing : Activating
Target Resource : execl
Interval(sec) : 60
Timeout (sec) : 120
Retry Count : 0
Final Action : Stop Cluster Daemon And
              OS Shutdown

Execute Script before Reactivation: Off
Execute Script before Failover : Off
Execute Script before Final Action: Off
Recovery Target : execl
Recovery Target Type : Resource
Recovery script Threshold : 0
Reactivation Threshold : 0
Failover Threshold : 1
Wait Time to Start Monitoring (sec): 0
Nice Value : 0
Monitor Suspend Possibility : Possible
Gather Dump When Timeout : Off
Execute Migration Before Failover: Off
Dummy Failure Possibility : Possible
IP Address : 127.0.0.1 (1)
Port : 110 (2)
Authority Method : APOP (3)
=====

```

**Explanation of each item**

- (1) IP Address : IP address of the monitor target
- (2) Port : Port number of pop3
- (3) Authority Method : Authority method of pop3

**Example of a command entry (For PostgreSQL monitor resource)**

```
# clpstat --mon psqlw1 --detail
```

**Example of the display after running the command:**

```
===== CLUSTER INFORMATION =====
[Monitor11 : psqlw1]
Type : psqlw
Comment : PostgreSQL monitor
Monitor Timing : Activating
Target Resource : execl
Interval(sec) : 60
Timeout (sec) : 120
Retry Count : 0
Final Action : Stop Cluster Daemon And
              OS Shutdown

Execute Script before Reactivation: Off
Execute Script before Failover : Off
Execute Script before Final Action: Off
Recovery Target : execl
Recovery Target Type : Resource
Recovery script Threshold : 0
Reactivation Threshold : 0
Failover Threshold : 1
Wait Time to Start Monitoring (sec): 0
Nice Value : 0
Monitor Suspend Possibility : Possible
Gather Dump When Timeout : Off
Execute Migration Before Failover: Off
Dummy Failure Possibility : Possible
Database Name : test (1)
IP Address : 127.0.0.1 (2)
Port : 5432 (3)
Table : psqlwatch (4)
Library Path : /usr/lib/libpq.so.3.0 (5)
Monitor Action : Level 2 (monitoring by update/select) (6)
=====
```

**Explanation of each item**

- |                    |                                                        |
|--------------------|--------------------------------------------------------|
| (1) Database Name  | : Name of the monitor target database                  |
| (2) IP Address     | : IP address to connect to PostgreSQL server           |
| (3) Port           | : Port number of PostgreSQL                            |
| (4) Table          | : Name of the table for monitoring created on database |
| (5) Library Path   | : Library path of PostgreSQL                           |
| (6) Monitor Action | : Monitor level                                        |

**Example of a command entry (For Samba monitor resource)**

**# clpstat --mon sambaw1 --detail**

**Example of the display after running the command:**

```

===== CLUSTER INFORMATION =====
[Monitor11 : sambaw1]
  Type                : sambaw
  Comment             : samba monitor
  Monitor Timing      : Activating
  Target Resource     : execl
  Interval(sec)       : 60
  Timeout (sec)       : 120
  Retry Count         : 0
  Final Action        : Stop Cluster Daemon And
                      OS Shutdown

  Execute Script before Reactivation: Off
  Execute Script before Failover   : Off
  Execute Script before Final Action: Off
  Recovery Target                  : execl
  Recovery Target Type              : Resource
  Recovery script Threshold         : 0
  Reactivation Threshold            : 0
  Failover Threshold                : 1
  Wait Time to Start Monitoring (sec): 0
  Nice Value                        : 0
  Monitor Suspend Possibility       : Possible
  Gather Dump When Timeout : Off
  Execute Migration Before Failover: Off
  Dummy Failure Possibility         : Possible
  Share Name                        : samba (1)
  IP Address                        : 127.0.0.1 (2)
  Port                              : 139 (3)
=====

```

**Explanation of each item**

- (1) Share Name : Shared name of monitor target Samba server
- (2) IP Address : IP address to connect to Samba server
- (3) Port : Port number of Samba server



**Example of a command entry (For SMTP monitor resource)**

```
# clpstat --mon smtpw1 --detail
```

**Example of the display after running the command:**

```
===== CLUSTER INFORMATION =====
[Monitor11 : smtpw1]
Type : smtpw
Comment : smtp monitor
Monitor Timing : Activating
Target Resource : execl
Interval(sec) : 60
Timeout (sec) : 120
Retry Count : 0
Final Action : Stop Cluster Daemon And
              OS Shutdown

Execute Script before Reactivation: Off
Execute Script before Failover : Off
Execute Script before Final Action: Off
Recovery Target : execl
Recovery Target Type : Resource
Recovery script Threshold : 0
Reactivation Threshold : 0
Failover Threshold : 1
Wait Time to Start Monitoring (sec): 0
Nice Value : 0
Monitor Suspend Possibility : Possible
Gather Dump When Timeout : Off
Execute Migration Before Failover: Off
Dummy Failure Possibility : Possible
IP Address : 127.0.0.1 (1)
Port : 25 (2)
=====
```

**Explanation of each item**

- (1) IP Address : IP address to connect to SMTP server
- (2) Port : Port number of SMTP server

**Example of a command entry (For Sybase monitor resource)**

```
# clpstat --mon sybasew1 --detail
```

**Example of the display after running the command:**

```
===== CLUSTER INFORMATION =====
[Monitor11 : sybasew1]
Type : sybasew
Comment : Sybase monitor
Monitor Timing : Activating
Target Resource : execl
Interval(sec) : 60
Timeout (sec) : 120
Retry Count : 0
Final Action : Stop Cluster Daemon And
              OS Shutdown

Execute Script before Reactivation: Off
Execute Script before Failover : Off
Execute Script before Final Action: Off
Recovery Target : execl
Recovery Target Type : Resource
Recovery script Threshold : 0
Reactivation Threshold : 0
Failover Threshold : 1
Wait Time to Start Monitoring (sec): 0
Nice Value : 0
Monitor Suspend Possibility : Possible
Gather Dump When Timeout : Off
Execute Migration Before Failover: Off
Dummy Failure Possibility : Possible
Database Name : MYDB (1)
Database Server Name : MYServer (2)
Table : mysqlwatch (3)
Library Path :
              /opt/sysbase/OCS-12_5/lib/libsybdb64.so (4)
Monitor Action : Level 2 (monitoring by update/select) (5)
=====
```

**Explanation of each item**

- (1) Database Name : Name of the monitor target database
- (2) Database Server Name : Name of the monitor target database server
- (3) Table : Name of the table for monitoring created on database
- (4) Library Path : Library path of Sybase
- (5) Monitor Action : Monitor level

**Example of a command entry (For Tuxedo monitor resource)**

```
# clpstat --mon tuxw1 --detail
```

**Example of the display after running the command:**

```
===== CLUSTER INFORMATION =====
[Monitor11 : tuxw1]
  Type                : tuxw
  Comment             : Tuxedo monitor
  Monitor Timing      : Activating
  Target Resource     : execl
  Interval(sec)       : 60
  Timeout (sec)       : 120
  Retry Count         : 0
  Final Action        : Stop Cluster Daemon And
                      OS Shutdown

  Execute Script before Reactivation: Off
  Execute Script before Failover   : Off
  Execute Script before Final Action: Off
  Recovery Target                   : execl
  Recovery Target Type               : Resource
  Recovery script Threshold          : 0
  Reactivation Threshold             : 0
  Failover Threshold                 : 1
  Wait Time to Start Monitoring (sec): 0
  Nice Value                         : 0
  Monitor Suspend Possibility        : Possible
  Gather Dump When Timeout           : Off
  Execute Migration Before Failover: Off
  Dummy Failure Possibility          : Possible
  Application Server Name             : BBL (1)
  Config File                        : /mnt/tuxedo/tuxconfig (2)
  Library Path                       :
                                      /opt/bea/tuxedo8.1/lib/libtux.so (3)
=====
```

**Explanation of each item**

- (1) Application Server Name : Name of the monitor target application server
- (2) Config File : Configuration file path of Tuxedo
- (3) Library Path : Library path of Tuxedo

**Example of a command entry (For WebLogic monitor resource)**

```
# clpstat --mon wlswl --detail
```

**Example of the display after running the command:**

```
===== CLUSTER INFORMATION =====
[Monitor11 : wlswl]
  Type                : wlsw
  Comment             : Weblogic monitor
  Monitor Timing      : Activating
  Target Resource     : execl
  Interval(sec)       : 60
  Timeout (sec)       : 120
  Retry Count         : 0
  Final Action        : Stop Cluster Daemon And
                      OS Shutdown

  Execute Script before Reactivation: Off
  Execute Script before Failover   : Off
  Execute Script before Final Action: Off
  Recovery Target                  : execl
  Recovery Target Type              : Resource
  Recovery script Threshold         : 0
  Reactivation Threshold            : 0
  Failover Threshold                : 1
  Wait Time to Start Monitoring (sec): 0
  Nice Value                        : 0
  Monitor Suspend Possibility       : Possible
Gather Dump When Timeout : Off
  Execute Migration Before Failover: Off
  Dummy Failure Possibility         : Possible
  IP Address                        : 127.0.0.1          (1)
  Port                              : 7002                (2)
  Authority Method                   : DemoTrust         (3)
  Domain Environment File             : /opt/bea/weblogic81/samples/
                                     domains/examples/setExamplesEnv.sh (4)
  Additional Command Option          : -Dwlst.offline.log=disable
-Duser.language=en_US (5)
=====
```

**Explanation of each item**

- (1) IP Address : IP address to connect to the application server
- (2) Port : Port number of Weblogic
- (3) Authority Method : Authority method of Weblogic
- Not Use SSL Authority is not performed
  - DemoTrust Authority method of using Weblogic authority file
  - CustomTrust General SSL authority method
- (4) Domain Environment File : Domain environment file path of Weblogic
- (5) Additional Command Option : Additional command option

**Example of a command entry (For WebSphere monitor resource)**

```
# clpstat --mon wasw1 --detail
```

**Example of the display after running the command:**

```
===== CLUSTER INFORMATION =====
[Monitor11 : wasw1]
Type : wasw
Comment : WebSphere monitor
Monitor Timing : Activating
Target Resource : execl
Interval(sec) : 60
Timeout (sec) : 120
Retry Count : 0
Final Action : Stop Cluster Daemon And
              OS Shutdown

Execute Script before Reactivation: Off
Execute Script before Failover : Off
Execute Script before Final Action: Off
Recovery Target : execl
Recovery Target Type : Resource
Recovery script Threshold : 0
Reactivation Threshold : 0
Failover Threshold : 1
Wait Time to Start Monitoring (sec): 0
Nice Value : 0
Monitor Suspend Possibility : Possible
Gather Dump When Timeout : Off
Execute Migration Before Failover: Off
Dummy Failure Possibility : Possible
Application Server Name : server1 (1)
Profile Name : default (2)
Install Path : (3)
              /opt/IBM/WebSphere/AppServer1
=====
```

**Explanation of each item**

- (1) Application Server Name : Name of the monitor target application server
- (2) Profile Name : Profile name of WebSphere
- (3) Install Path : Install path of WebSphere

**Example of a command entry (For WebOTX monitor resource)**

```
# clpstat --mon otxw1 --detail
```

**Example of the display after running the command:**

```
===== CLUSTER INFORMATION =====
[Monitor11 : otxw1]
Type                               : otxw
Comment                             : WebOTX monitor
Monitor Timing                       : Activating
Target Resource                      : execl
Interval(sec)                       : 60
Timeout (sec)                       : 120
Retry Count                         : 1
Final Action                         : Stop Cluster Daemon And
                                   OS Shutdown

Execute Script before Reactivation: Off
Execute Script before Failover      : Off
Execute Script before Final Action: Off
Recovery Target                    : execl
Recovery Target Type                : Resource
Recovery script Threshold           : 0
Reactivation Threshold              : 0
Failover Threshold                  : 1
Wait Time to Start Monitoring (sec): 0
Nice Value                          : 0
Monitor Suspend Possibility         : Possible
Gather Dump When Timeout      : Off
Execute Migration Before Failover: Off
Dummy Failure Possibility           : Possible
Connecting Destination               : localhost          (1)
Port                                 : 6212              (2)
Install Path                         : /opt/WebOTX        (3)
=====
```

**Explanation of each item**

- (1) Connecting Destination : Name of the monitor target application server
- (2) Port : Port number of WebOTX
- (3) Install Path : Install path of WebOTX

**Example of a command entry (For JVM monitor resource)**

```
# clpstat --mon jraw --detail
```

**Example of the display after running the command:**

```
===== CLUSTER INFORMATION =====
[Monitor11 : jraw1]
Type : jraw
Comment : JVM_monitor
Monitor Timing : Always
Target Resource :
Interval(sec) : 60
Timeout (sec) : 120
Retry Count : 0
Final Action : No Operation
Execute Script before Reactivation: Off
Execute Script before Failover : Off
Execute Script before Final Action : Off
Recovery Target : LocalServer
Recovery Target Type : Itself
Recovery script Threshold : 0
Reactivation Threshold : 0
Failover Threshold : 0
Wait Time to Start Monitoring (sec): 0
Nice Value : 0
Monitor Suspend Possibility : Possible
Gather Dump When Timeout : Off
Execute Migration Before Failover: Off
Dummy Failure Possibility : Possible
Target : Tomcat (1)
JVM Type : Oracle Java (2)
Name : Tomcat (3)
Connection Port Number : 9005 (4)
Process Name : com.sun.management.jmxremote.port=9005(5)
=====
```

**Explanation of each item**

- |                            |                                                       |
|----------------------------|-------------------------------------------------------|
| (1) Target                 | : Type of a target to be monitored                    |
| (2) JVM Type               | : Type of Java VM of a target to be monitored         |
| (3) Name                   | : Identifier of Java VM of a target to be monitored   |
| (4) Connection Port Number | : Connection port number of a target to be monitored  |
| (5) Process Name           | : Process name of Java VM of a target to be monitored |

**Example of a command entry (For a system monitor resource)****# clpstat --mon sraw --detail****Example of the display after running the command:**

```

===== CLUSTER INFORMATION =====
[Monitor11 : sraw1]
Type : sraw
Comment : system_monitor
Monitor Timing : Activating
Target Resource : execl
Interval(sec) : 30
Timeout (sec) : 60
Retry Count : 0
Final Action : No Operation
Execute Script before Reactivation: Off
Execute Script before Failover : Off
Execute Script before Final Action: Off
Recovery Target : execl
Recovery Target Type : Resource
Recovery script Threshold : 0
Reactivation Threshold : 0
Failover Threshold : 0
Wait Time to Start Monitoring (sec): 0
Nice Value : 0
Monitor Suspend Possibility : Possible
Gather Dump When Timeout : Off
Execute Migration Before Failover: Off
Dummy Failure Possibility : Possible
System : Monitoring CPU Usage : On (1)
System : CPU Rate (%) : 90 (2)
System : CPU Monitoring Duration (sec) : 3600 (3)
System : Monitoring Memory Usage: On (4)
System : Memory Usage Rate (%) : 90 (5)
System : Memory Usage Monitoring Duration (sec) : 3600 (6)
System : Monitoring Virtual Memory Usage : On (7)
System : Virtual Memory(VM) Usage Rate (%) : 90 (8)
System : VM Usage Monitoring Duration (sec) : 3600 (9)
System : Monitoring Open File Num: On (10)
System : Open File Num Rate (%) : 90 (11)
System : Open File Num Monitoring Duration (sec) : 3600 (12)
System : Monitoring Thread Usage: On (13)
System : Thread Usage Rate (%) : 90 (14)
System : Thread Usage Monitoring Duration (sec) : 3600 (15)
System : Monitoring Max User Process Count : On (16)
System : Max User Process Count (%) : 90 (17)
System : Max User Process Monitoring Duration (sec) : 3600 (18)
Process : Monitoring CPU Usage : On (19)
Process : Monitoring Memory Leak: On (20)
Process : Monitoring File Leak : On (21)

```



```

Process : Monitoring Open File Num
                : On (22)
Process : Monitoring Thread Leak : On (23)
Process : Monitoring Defunct Process : On (24)
Process : Monitoring Same Name Process Count : On (25)
Disk : Mount Point : (26)

```

---

**Explanation of each item**

- |                                                    |                                                                                  |
|----------------------------------------------------|----------------------------------------------------------------------------------|
| (1) System : Monitoring CPU Usage                  | : Monitoring CPU usage error                                                     |
| (2) System : CPU Rate                              | : Threshold for detecting a CPU usage error (%)                                  |
| (3) System : CPU Monitoring Duration               | : Time during which to detect a CPU usage error (sec)                            |
| (4) System : Monitoring Memory Usage               | : Monitoring memory usage error                                                  |
| (5) System : Memory Usage Rate                     | : Threshold for detecting a memory usage error (%)                               |
| (6) System : Memory Usage Monitoring Duration      | : Time during which to detect a memory usage error (sec)                         |
| (7) System : Monitoring Virtual Memory Usage       | : Monitoring virtual memory usage error                                          |
| (8) System : Virtual Memory(VM) Usage Rate         | : Threshold for detecting a virtual memory usage error (%)                       |
| (9) System : VM Usage Monitoring Duration          | : Time during which to detect a virtual memory usage error (sec)                 |
| (10) System : Monitoring Open File Num             | : Monitoring total open file count error                                         |
| (11) System : Open File Num Rate                   | : Threshold for detecting a total open file count error (%)                      |
| (12) System : Open File Num Monitoring Duration    | : Time during which to detect a total open file count error (sec)                |
| (13) System : Monitoring Thread Usage              | : Monitoring total thread count error                                            |
| (14) System : Thread Usage Rate                    | : Threshold for detecting a total thread count error (%)                         |
| (15) System : Thread Usage Monitoring Duration     | : Time during which to detect a total thread count error (sec)                   |
| (16) System : Monitoring Max User Process Count    | : Monitoring number of running processes per user error                          |
| (17) System : Max User Process Count               | : Threshold for detecting a number of running processes per user error (%)       |
| (18) System : Max User Process Monitoring Duration | : Time during which to detect a number of running processes per user error (sec) |
| (19) Process : Monitoring CPU Usage                | : Monitoring CPU usage error                                                     |
| (20) Process : Monitoring Memory Leak              | : Monitoring memory leak error                                                   |
| (21) Process : Monitoring File Leak                | : Monitoring file leak error                                                     |
| (22) Process : Monitoring Open File Num            | : Monitoring total open file count error                                         |
| (23) Process : Monitoring Thread Leak              | : Monitoring thread leak error                                                   |
| (24) Process : Monitoring Defunct Process          | : Monitoring defunct process error                                               |
| (25) Process : Monitoring Same Name Process Count  | : Monitoring number of same name process error                                   |

(26) Disk : Mount Point

: Mount point

**Example of a command entry** (for AWS elastic ip monitor resources)

```
# clpstat --mon awseipw1 --detail
```

**Example of the display after running the command**

```
===== CLUSTER INFORMATION =====
[Monitor2 : awseipw1]
Type : awseipw
Comment :
Monitor Timing : Activating
Target Resource :
Interval (sec) : 5
Timeout (sec) : 10
Retry Count : 0
Final Action : No Operation
Execute Script before Reactivation : Off
Execute Script before Failover : Off
Execute Script before Final Action : Off
Recovery Target : LocalServer
Recovery Target Type : Itself
Recovery Script Threshold : 0
Reactivation Threshold : 0
Failover Threshold : 0
Wait Time to Start Monitoring (sec) : 0
Nice Value : 0
Monitor Suspend Possibility : Possible
Gather Dump When Timeout : Off
Execute Migration Before Failover : Off
Dummy Failure Possibility : Possible
Action when AWS CLI command failed to receive response :
Disable recovery action(Display warning) (1)
=====
```

**Explanation of each item**

- (1) Action when AWS CLI command failed to receive response    Action at AWS CLI command response acquisition failure

**Example of a command entry** (for AWS virtual ip monitor resources)

**# clpstat --mon awsvipw1 --detail**

**Example of the display after running the command**

```

===== CLUSTER INFORMATION =====
[Monitor2 : awsvipw1]
Type : awsvipw
Comment :
Monitor Timing : Activating
Target Resource :
Interval (sec) : 5
Timeout (sec) : 10
Retry Count : 0
Final Action : No Operation
Execute Script before Reactivation : Off
Execute Script before Failover : Off
Execute Script before Final Action : Off
Recovery Target : LocalServer
Recovery Target Type : Itself
Recovery Script Threshold : 0
Reactivation Threshold : 0
Failover Threshold : 0
Wait Time to Start Monitoring (sec) : 0
Nice Value : 0
Monitor Suspend Possibility : Possible
Gather Dump When Timeout : Off
Execute Migration Before Failover : Off
Dummy Failure Possibility : Possible
Action when AWS CLI command failed to receive response :
Disable recovery action(Display warning) (1)
=====
  
```

**Explanation of each item**

- (1) Action when AWS CLI command failed to receive response    Action at AWS CLI command response acquisition failure

**Example of a command entry ( for AWS AZ monitor resources)**

```
# clpstat --mon awsazw1 --detail
```

**Example of the display after running the command:**

```
===== CLUSTER INFORMATION =====
[Monitor2 : awsazw1]
Type : awsazw
Comment :
Monitor Timing : Always
Target Resource :
Interval (sec) : 5
Timeout (sec) : 10
Retry Count : 0
Final Action : No Operation
Execute Script before Reactivation : Off
Execute Script before Failover : Off
Execute Script before Final Action : Off
Recovery Target : LocalServer
Recovery Target Type : Itself
Recovery Script Threshold : 0
Reactivation Threshold : 0
Failover Threshold : 0
Wait Time to Start Monitoring (sec) : 0
Nice Value : 0
Monitor Suspend Possibility : Possible
Gather Dump When Timeout : Off
Execute Migration Before Failover : Off
Dummy Failure Possibility : Possible
Availability Zone : ap-northeast-1a (1)
Action when AWS CLI command failed to receive response :
Disable recovery action(Display warning) (2)
=====
```

**Explanation of each item**

- (1) Availability Zone : Availability zone
- (2) Action when AWS CLI command failed to receive response : Action at AWS CLI command response acquisition failure

**Example of a command entry** (for Azure probe port monitor resources)

**# clpstat --mon azureppw1 --detail**

**Example of the display after running the command:**

```

===== CLUSTER INFORMATION =====
[Monitor2 : azureppw1]
Type : azureppw
Comment :
Monitor Timing : Activating
Target Resource : azure1
Interval (sec) : 5
Timeout (sec) : 10
Retry Count : 0
Final Action : No Operation
Execute Script before Reactivation : Off
Execute Script before Failover : Off
Execute Script before Final Action : Off
Recovery Target : LocalServer
Recovery Target Type : Itself
Recovery Script Threshold : 0
Reactivation Threshold : 0
Failover Threshold : 0
Wait Time to Start Monitoring (sec) : 0
Nice Value : 0
Monitor Suspend Possibility : Possible
Gather Dump When Timeout : Off
Execute Migration Before Failover : Off
Dummy Failure Possibility : Possible
Action when Probe port wait timeout :
Disable recovery action(Do nothing) (1)
=====
    
```

**Explanation of each item**

- (1) Action when Probe port wait timeout : Action at probe port wait timeout.

**Example of a command entry** (for Azure load balance monitor resources)

```
# clpstat --mon azurelbw1 --detail
```

**Example of the display after running the command:**

```
===== CLUSTER INFORMATION =====
[Monitor2 : azurelbw1]
Type : azurelbw
Comment :
Monitor Timing : Always
Target Resource : azurepp1
Interval (sec) : 5
Timeout (sec) : 10
Retry Count : 0
Final Action : No Operation
Execute Script before Reactivation : Off
Execute Script before Failover : Off
Execute Script before Final Action : Off
Recovery Target : LocalServer
Recovery Target Type : Itself
Recovery Script Threshold : 0
Reactivation Threshold : 0
Failover Threshold : 0
Wait Time to Start Monitoring (sec) : 0
Nice Value : 0
Monitor Suspend Possibility : Possible
Gather Dump When Timeout : Off
Execute Migration Before Failover : Off
Dummy Failure Possibility : Possible
Monitor Target : azurepp1 (1)
=====
```

**Explanation of each item**

(1) Monitor Target : Monitor target resource.

## Displaying the configuration data of a resource specified for an individual server (--rsc option or --mon option)

When you want to display the configuration data on a resource specified for an individual server, specify the name of the resource after the --rsc or --mon option in the clpstat command.

**Example of a command entry (When the monitor target IP address of the IP monitor resource is set to an individual server)**

```
# clpstat --mon ipw1
```

**Example of the display after running the command:**

```
===== CLUSTER INFORMATION =====
[Monitor2 : ipw1]
  Type           : ipw
  Comment        : ip monitor1
  IP Addresses   : Refer to server's setting
                                     -> see (1)
<server1>
  IP Addresses   : 10.0.0.253         -> see (2)
                 : 10.0.0.254
<server2>
  IP Addresses   : 10.0.1.253         -> see (3)
                 : 10.0.1.254
=====
```

### Explanation of each item

- |                  |                                                                                                  |
|------------------|--------------------------------------------------------------------------------------------------|
| (1) IP Addresses | : When the IP address is set for an individual server, "Refer to server's setting" is displayed. |
| (2) IP Addresses | : Monitor target IP address used on server1                                                      |
| (3) IP Addresses | : Monitor target IP address used on server2                                                      |



## Displaying all configuration data (-i option)

By specifying the `-i` option, you can display the configuration information that is shown when `--cl`, `--sv`, `--hb`, `--svg`, `--grp`, `--rsc`, and `--mon` options are all specified.

If you run the command with the `-i` option and the `--detail` option together, all the detailed cluster configuration data is displayed. Because this option displays large amount of information at a time, use a command, such as the `less` command, and `pipe`, or redirect the output in a file for the output.

### ◆ Tips

Specifying the `-i` option displays all the information on a console. If you want to display some of the information, it is useful to combine the `--cl`, `--sv`, `--hb`, `--svg`, `--grp`, `--rsc`, and/or `--mon` option. For example, you can use these options as follows:

### Example of a command entry:

If you want to display the detailed information of the server whose name is “server0,” the group whose name is “failover1,” and the group resources of the specified group, enter:

```
# clpstat --sv server0 --grp failover1 --rsc --detail
```

## Displaying the status of the cluster (--local option)

By specifying the `--local` option, you can display only information of the server on which you execute the `clpstat` command, without communicating with other servers.

### Example of a command entry

```
# clpstat --local
```

### Example of the display after running the command

```
===== CLUSTER STATUS =====
Cluster : cluster -> See (1)
  cluster      : Start      cluster      -> See (2)
<server>
  *server1 .....: Online    server1      -> See (3)
    lanhb1      : Normal    LAN Heartbeat -> See (4)
    lanhb2      : Normal    LAN Heartbeat -> See (4)
    diskhb1     : Normal    DISK Heartbeat -> See (4)
    comhb1      : Normal    COM Heartbeat -> See (4)
    pingnp1     : Normal    ping resolution -> See (5)
    pingnp2     : Normal    ping resolution -> See (5)

  server2 .....: Online    server2      -> See (3)
    lanhb1      : -         LAN Heartbeat -> See (4)
    lanhb2      : -         LAN Heartbeat -> See (4)
    diskhb1     : -         DISK Heartbeat -> See (4)
    comhb1      : -         COM Heartbeat -> See (4)
    pingnp1     : -         ping resolution -> See (5)
    pingnp2     : -         ping resolution -> See (5)

<group>
  failover1 .....: Online    failover group1 ->See (6)
    current      : server1
    disk1        : Online    /dev/sdb5      ->See (7)
    execl        : Online    exec resource1 ->See (7)
    fip1         : Online    10.0.0.11     ->See (7)
  failover2 .....: -         failover group2 ->See (6)
    current      : server2
    disk2        : -         /dev/sdb6      ->See (7)
    exec2        : -         exec resource2 ->See (7)
    fip2         : -         10.0.0.12     ->See (7)
<monitor> ->See (8)
  diskw1        : Online    disk monitor1  ->See (9)
  diskw2        : Online    disk monitor2  ->See (9)
  ipw1          : Online    ip monitor1    ->See (9)
  pidw1         : Online    pidw1          ->See (9)
  userw         : Online    usermode monitor ->See (9)
  sraw          : Online    sra monitor    ->See (9)
=====
```

### Explanation of each item

- (1) Cluster : Cluster name
- (2) Cluster name : Status Cluster comment
- (3) Server name : Status Server comment  
 "\*" indicates the server has executed this command.

- 
- (4) Heartbeat resource name : Status Heartbeat resource comment  
The heartbeat resource status of a server other than the server on which this command is executed is not displayed.
- (5) Network partition resolution resource name  
: Status Network partition resolution resource comment  
The network partition resolution resource status of a server other than the server on which this command is executed is not displayed.
- (6) Group name : Status Group comment  
Current : Status Server name  
Shows the server to which the group belongs now.  
The status of the group that is running on a server other than the server on which this command is executed is not displayed.
- (7) Group Resource Name : Status Group resource comment  
The status of the resource that is running on a server other than the server on which this command is executed is not displayed.
- (8) The following descriptions are displayed after the monitor resource name.
- If the monitor resource contains an error and the recovery action is restricted, "Recovery Action Disabled" is displayed.
  - If dummy failure occurred in the monitor resource, "Failure Verification" is displayed.
- (9) Monitor Resource Name : Status Monitor resource comment  
The status of the monitor resource of the server on which this command is executed is displayed. If dummy failure occurred in the monitor resource, "(Dummy Failure)" is added after the status.

Information on each status is provided in "Status Descriptions" on page 392.

## Status Descriptions

Cluster		
Function	Status	Description
Status display (--local)	Start	Starting
	Suspend	Being suspended
	Stop	Offline Pending
	Unknown	Status unknown

Server		
Function	Status	Description
Status display	Online	Starting
Heartbeat resource status display	Offline	Offline Pending
	Online Pending	Now being started
	Offline Pending	Now being stopped
	Warning	Heartbeat resource failure
	Unknown	Status unknown
	-	Status unknown
Group map display	o	Starting
Monitor resource status display	x	Offline Pending
	-	Status unknown

Heartbeat Resource		
Function	Status	Description
Status display	Normal	Normal
	Warning	Failure (Some)
	Error	Failure (All)
	Unused	Not used
	Unknown	Status unknown
	-	Status unknown
Heartbeat resource status display	o	Able to communicate
	x	Unable to communicate
	-	Not used or status unknown

Network Partition Resolution Resource		
Function	Status	Description
Status display	Normal	Normal
	Error	Failure
	Unused	Not used
	Unknown	Status unknown
	-	Status unknown
Network partition resolution	o	Able to communicate

status display	x	Unable to communicate
	-	Not used or status unknown

<b>Group</b>		
<b>Function</b>	<b>Status</b>	<b>Description</b>
Status display	Online	Started
	Offline	Stopped
	Online Pending	Now being started
	Offline Pending	Now being stopped
	Error	Error
	Unknown	Status unknown
	-	Status unknown
Group map display	o	Started
	e	Error
	p	Now being started/stopped

<b>Group Resource</b>		
<b>Function</b>	<b>Status</b>	<b>Description</b>
Status display	Online	Started
	Offline	Stopped
	Online Pending	Now being started
	Offline Pending	Now being stopped
	Online Failure	Starting failed
	Offline Failure	Stopping failed
	Unknown	Status unknown
	-	Status unknown

<b>Monitor Resource</b>		
<b>Function</b>	<b>Status</b>	<b>Description</b>
Status Display	Normal	Normal
	Warning	Error (Some)
	Error	Error (All)
	Not Used	Not Used
	Unknown	Status Unknown
Status display (--local) Monitor Resource Status Display	Online	Started
	Offline	Stopped
	Warning	Warning
	Suspend	Stopped temporary
	Online Pending	Now being started
	Offline Pending	Now being stopped
	Online Failure	Starting failed
	Offline Failure	Stopping failed

	Not Used	Not used
	Unknown	Status unknown
	-	Status unknown

## Operating the cluster (clpcl command)

**clpcl:** the `clpcl` command operates a cluster

**Command line:**

```
clpcl -s [-a] [-h hostname]
clpcl -t [-a] [-h hostname] [-w time-out] [--apito timeout]
clpcl -r [-a] [-h hostname] [-w time-out] [--apito timeout]
clpcl --suspend [--force] [-w time-out] [--apito timeout]
clpcl --resume
```

**Description** This command starts, stops, suspends, or resumes the cluster daemon.

<b>Option</b>	-s	Starts the cluster daemon.
	-t	Stops the cluster daemon.
	-r	Restarts the cluster daemon.
	--suspend	Suspends the entire cluster
	-w <i>time-out</i>	<code>clpcl</code> command specifies the wait time to stop or suspend the cluster daemon to be completed when <code>-t</code> , <code>-r</code> , or <code>--suspend</code> option is used. The unit of time is second.  When a time-out is not specified, it waits for unlimited time. When "0 (zero)" is specified, it does not wait. When <code>-w</code> option is not specified, it waits for (heartbeat time-out x 2) seconds.
	--resume	Resumes the entire cluster. The status of group resource of the cluster when suspended is kept.
	-a	Executed the command on all servers
	-h <i>hostname</i>	Makes a request to run the command to the server specified in <i>hostname</i> . Makes a processing request to the server on which this command runs (local server) if the <code>-h</code> option is omitted.
	--force	When used with the <code>--suspend</code> option, forcefully suspends the cluster regardless of the status of all the servers in the cluster.
	--apito <i>timeout</i>	Specify the interval (internal communication timeout) to wait for the EXPRESSCLUSTER daemon start or stop in seconds. A value from 1 to 9999 can be specified.  If the <code>--apito</code> option is not specified, waiting for the EXPRESSCLUSTER daemon start or stop is performed according to the value set to the internal communication timeout of the cluster properties.

<b>Return Value</b>	0	Success
	Other than 0	Failure

**Remarks** When this command is executed with the `-s` or `--resume` option

specified, it returns control when processing starts on the target server.

When this command is executed with the `-t` or `--suspend` option specified, it returns control after waiting for the processing to complete.

When this command is executed with the `-r` option specified, it returns control when the EXPRESSCLUSTER daemon restarts on the target server after stopping once.

Run the `clpstat` command to display the started or resumed status of the EXPRESSCLUSTER daemon.

#### Notes

Run this command as the root user.

This command cannot be executed while a group is being started or stopped.

For the name of a server for the `-h` option, specify the name of a server in the cluster.

When you suspend the cluster, the cluster daemon should be activated in all servers in the cluster. When the `--force` option is used, the cluster is forcefully suspended even if there is any stopped server in the cluster.

When you start up or resume the cluster, access the servers in the cluster in the order below, and use one of the paths that allowed successful access.

1. via the IP address on the interconnect LAN
2. via the IP address on the public LAN

When you resume the cluster, use the `clpstat` command to see there is no activated server in the cluster.

This command starts, stops, restarts, suspends, or resumes only the EXPRESSCLUSTER daemon. The mirror agent and the like are not started, stopped, restarted, suspended, or resumed together.

#### Example of a command entry

**Example 1:** Activating the cluster daemon in the local server

```
# clpcl -s
```

**Example 2:** Activating the cluster daemon in server1 from server0

```
# clpcl -s -h server1
```

```
Start server1 : Command succeeded.
```

If a server name is specified, the display after running the command should look similar to above.

Start *hostname* : Execution result

(If the activation fails, cause of the failure is displayed)

**Example 3:** Activating the cluster daemon in all servers

```
# clpcl -s -a
```

```
Start server0 : Command succeeded.
```

```
Start server1 : Performed startup processing to the active cluster daemon. When all the servers are activated, the display after running the command should look similar to above. Start hostname : Execution result
```

(If the activation fails, cause of the failure is displayed)



**Example 4:** Stopping the cluster daemon in all servers

```
# clpcl -t -a
```

If the cluster daemon stops on all the servers, it waits till the EXPRESSCLUSTER daemons stop on all the servers.

If stopping fails, an error message is displayed.

**Error Messages**

Message	Cause/Solution
Log in as root.	Log on as the root user.
Invalid configuration file. Create valid cluster configuration data by using the Builder.	Create valid cluster configuration data using the Builder.
Invalid option.	Specify a valid option
Performed stop processing to the stopped cluster daemon.	The stopping process has been executed on the stopped cluster daemon.
Performed startup processing to the active cluster daemon.	The startup process has been executed on the activated cluster daemon.
Could not connect to the server. Check if the cluster daemon is active.	Check if the cluster daemon is activated.
Could not connect to the data transfer server. Check if the server has started up.	Check if the server is running.
Failed to obtain the list of nodes. Specify a valid server name in the cluster.	Specify the valid name of a server in the cluster.
Failed to obtain the daemon name.	Failed to obtain the cluster name.
Failed to operate the daemon.	Failed to control the cluster.
Resumed the daemon that is not suspended.	Performed the resume process for the HA Cluster daemon that is not suspended.
Invalid server status.	Check that the cluster daemon is activated.
Server is busy. Check if this command is already run.	This command may have already been run.
Server is not active. Check if the cluster daemon is active.	Check if the cluster daemon is activated.
There is one or more servers of which cluster daemon is active. If you want to perform resume, check if there is any server whose cluster daemon is active in the cluster.	When you execute the command to resume, check if there is no server in the cluster on which the cluster daemon is activated.
All servers must be activated. When suspending the server, the cluster daemon need to be active on all servers in the cluster.	When you execute the command to suspend, the cluster daemon must be activated in all servers in the cluster.
Resume the server because there is one or more suspended servers in the cluster.	Execute the command to resume because some server(s) in the cluster is in the suspend status.
Invalid server name. Specify a valid server name in the cluster.	Specify the valid name of a sever in the cluster.

Message	Cause/Solution
Connection was lost. Check if there is a server where the cluster daemon is stopped in the cluster.	Check if there is any server on which the cluster daemon is stopped in the cluster.
Invalid parameter.	The value specified as a command parameter may be invalid.
Internal communication timeout has occurred in the cluster server. If it occurs frequently, set the longer timeout.	A time-out occurred in the HA Cluster internal communication. If time-out keeps occurring, set the internal communication time-out longer.
Processing failed on some servers. Check the status of failed servers.	If stopping has been executed with all the servers specified, there is one of more servers on which the stopping process has failed. Check the status of the server(s) on which the stopping process has failed.
Internal error. Check if memory or OS resources are sufficient.	Check to see if the memory or OS resource is sufficient.
There is a server that is not suspended in cluster. Check the status of each server.	There is a server that is not suspended in the cluster. Check the status of each server.
Suspend %s : Could not suspend in time.	The server failed to complete the suspending process of the cluster daemon within the time-out period. Check the status of the server.
Stop %s : Could not stop in time.	The server failed to complete the stopping process of the cluster daemon within the time-out period. Check the status of the server.
Stop %s : Server was suspended. Could not connect to the server. Check if the cluster daemon is active.	The request to stop the cluster daemon was made. However the server was suspended.
Could not connect to the server. Check if the cluster daemon is active.	The request to stop the cluster daemon was made. However connecting to the server failed. Check the status of the server.
Suspend %s : Server already suspended. Could not connect to the server. Check if the cluster daemon is active.	The request to suspend the cluster daemon was made. However the server was suspended.
Event service is not started.	Event service is not started. Check it.
Mirror Agent is not started.	Mirror Agent is not started. Check it.
Event service and Mirror Agent are not started.	Event service and Mirror Agent are not started. Check them.
Some invalid status. Check the status of cluster.	The status of a group may be changing. Try again after the status change of the group is complete.

## Shutting down a specified server (clpdown command)

**clpdown:** the `clpdown` command shuts down a specified server.

### Command line

```
clpdown [-r] [-h hostname]
```

<b>Description</b>	This command stops the cluster daemon and shuts down a server.	
<b>Option</b>	None	Shuts down a server.
	<code>-r</code>	Reboots the server.
	<code>-h <i>hostname</i></code>	Makes a processing request to the server specified in <i>hostname</i> . Makes a processing request to the server on which this command runs (local server) if the <code>-h</code> option is omitted.
<b>Return Value</b>	0	Success
	Other than 0	Failure
<b>Remarks</b>	<p>This command runs the following commands internally after stopping the cluster daemon.</p> <p>Without any option specified    Shut down</p> <p>With the <code>-r</code> option specified    reboot</p> <p>This command returns control when the group stop processing is completed.</p>	
<b>Notes</b>	<p>Run this command as the root user.</p> <p>This command cannot be executed while a group is being started or stopped.</p> <p>For the name of a server for the <code>-h</code> option, specify the name of a server in the cluster.</p>	
<b>Example of a command entry</b>	<p><b>Example 1:</b> Stopping and shutting down the cluster daemon in the local server</p> <pre># clpdown</pre> <p><b>Example 2:</b> Shutting down and rebooting server1 from server0</p> <pre># clpdown -r -h server1</pre>	
<b>Error Message</b>	See “Operating the cluster (clpcl command)” on page 395.	

## Shutting down the entire cluster (clpstdn command)

**clpstdn:** the `clpstdn` command shuts down the entire cluster

### Command line

```
clpstdn [-r] [-h hostname]
```

<b>Description</b>	This command stops the cluster daemon in the entire cluster and shuts down all servers.	
<b>Option</b>	None	Executes cluster shutdown.
	-r	Executes cluster shutdown reboot.
	-h <i>hostname</i>	Makes a processing request to the server specified in <i>hostname</i> . Makes a processing request to the server on which this command runs (local server) if the -h option is omitted.
<b>Return Value</b>	0	Success
	Other than 0	Failure
<b>Remarks</b>	This command returns control when the group stop processing is completed.	
<b>Notes</b>	<p>Run this command as the root user.</p> <p>This command cannot be executed while a group is being started or stopped.</p> <p>For the name of a server for the -h option, specify the name of a server in the cluster.</p> <p>A server that cannot be accessed from the server that runs the command (for example, a server with all LAN heartbeat resources are off-line.) will not shut down.</p>	
<b>Example of a command entry</b>	<p><b>Example 1:</b> Shutting down the cluster</p> <pre># clpstdn</pre> <p><b>Example 2:</b> Performing the cluster shutdown reboot</p> <pre># clpstdn -r</pre>	
<b>Error Message</b>	See “Operating the cluster (clpcl command)” on page 395.	

## Operating groups (clpgrp command)

**clpgrp**: the `clpgrp` command operates groups

### Command line

```
clpgrp -s [group_name] [-h hostname] [-f] [--apito timeout]
clpgrp -t [group_name] [-h hostname] [-f] [--apito timeout]
clpgrp -m [group_name] [-h hostname] [-a hostname] [--apito timeout]
clpgrp -l [group_name] [-h hostname] [-a hostname] [--apito timeout]
```

<b>Description</b>	This command starts, deactivates or moves groups. This command also migrates groups.	
<b>Option</b>	<p><code>-s</code> [<i>group_name</i>]</p> <p><code>-t</code> [<i>group_name</i>]</p> <p><code>-m</code> [<i>group_name</i>]</p> <p><code>-l</code> [<i>group_name</i>]</p> <p><code>-h</code> <i>hostname</i></p> <p><code>-a</code> <i>hostname</i></p> <p><code>-f</code></p> <p><code>-n</code> <i>group_name</i></p> <p><code>--apito</code> <i>timeout</i></p>	<p>Starts groups. When you specify the name of a group, only the specified group starts up. If no group name is specified, all groups start up.</p> <p>Stops groups. When you specify the name of a group, only the specified group stops. If no group name is specified, all groups stop.</p> <p>Moves a specified group. If no group name is specified, all the groups are moved. The status of the group resource of the moved group is kept.</p> <p>Migrates the specified group. The group type must always be the migration type. If no group name is specified, all the active migration groups on the server are migrated.</p> <p>Makes a processing request to the server specified in <i>hostname</i>. Makes a processing request to the server on which this command runs (local server) if the <code>-h</code> option is omitted.</p> <p>Defines the server which is specified by <i>hostname</i> as a destination to which a group will be moved. When the <code>-a</code> option is omitted, the group will be moved according to the failover policy</p> <p>If you use this option with the <code>-s</code> option against a group activated on a remote server, it will forcefully be started on the server that requested the process. If this command is used with the <code>-t</code> option, the group will be stopped forcefully.</p> <p>Displays the name of the server on which the group has been started.</p> <p>Specify the interval (internal communication timeout) to wait for the group resource start or stop in seconds. A value from 1 to 9999 can be specified. If the <code>--apito</code> option is not specified, waiting for the group resource start or stop is performed according to the value set to the internal communication timeout of the cluster properties.</p>

**Return Value** 0 Success

Other than 0            Failure

**Notes**

Run this command as the root user.

The cluster daemon must be activated on the server that runs this command

Specify a server in the cluster when you specify the name of server name for the `-h` and `-a` options.

Make sure to specify a group name, when you use the `-m` option.

When “Normal” is configured for the failover exclusion attribute of a group and you want to move the group with the `-m` option, explicitly specify a server to which the group is moved by using the `-a` option.

Moving a group will fail when “Normal” groups in all servers to which the group can be moved are activated if you omit the `-a` option.

**Example of Execution**

The following is an example of status transition when operating the groups.

Example: The cluster has two servers and two groups.

Failover policy of group

groupA server1 -> server2

groupB server2 -> server1

1. Both groups are stopped.

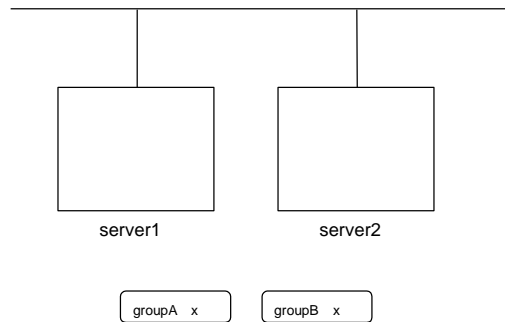

2. Run the following command on server1.

**# clpgrp -s groupA**

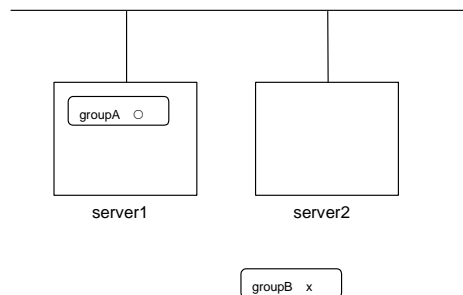

GroupA starts in server1.

3. Run the following command in server2.

```
# clpgrp -s
```

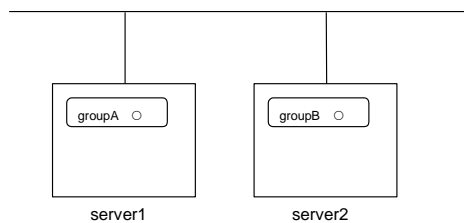

All groups that are currently stopped but can be started start in server2.

4. Run the following command in server1

```
# clpgrp -m groupA
```

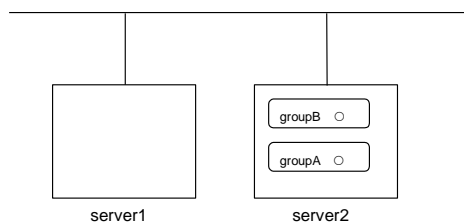

GroupA moves to server2.

5. Run the following command in server1

```
# clpgrp -t groupA -h server2
```

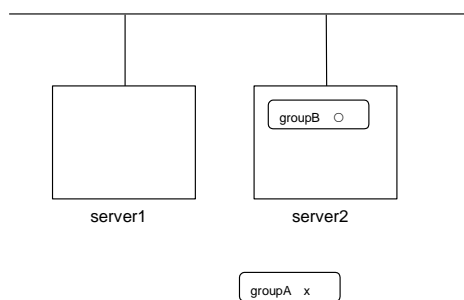

GroupA stops.

6. Run the following command in server1.

```
# clpgrp -t
```

Command Succeeded.

When the command is executed, there is no group running on server1. So, "Command Succeeded." appears.



7. Add `-f` to the command you have run in Step 6 and execute it on server1.

```
# clpgrp -t -f
```

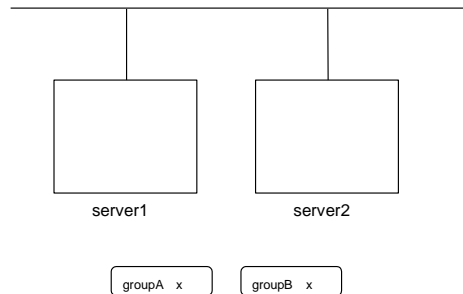

Groups which were started in server2 can be forcefully deactivated from server1.

### Error message

Message	Cause/Solution
Log in as root.	Log on as the root user.
Invalid configuration file. Create valid cluster configuration data by using the Builder.	Create valid cluster configuration data using the Builder
Invalid option.	Specify a valid option
Could not connect to the server. Check if the cluster daemon is active.	Check if the cluster daemon is activated.
Invalid server status.	Check if the cluster daemon is activated.
Server is not active. Check if the cluster daemon is active.	Check if the cluster daemon is activated.
Invalid server name. Specify a valid server name in the cluster.	Specify the valid name of sever in the cluster.
Connection was lost. Check if there is a server where the cluster daemon is stopped in the cluster.	Check if there is any server on which the cluster daemon has stopped in the cluster.
Invalid parameter.	The value specified as a command parameter may be invalid.
Internal communication timeout has occurred in the cluster server. If it occurs frequently, set a longer timeout.	A time-out occurred in the EXPRESSCLUSTER internal communication. If time-out keeps occurring, set the internal communication time-out longer.
Invalid server. Specify a server that can run and stop the group, or a server that can be a target when you move the group.	The server that starts/stops the group or to which the group is moved is invalid. Specify a valid server.
Could not start the group. Try it again after the other server is started, or after the Wait Synchronization time is timed out.	Start up the group after waiting for the remote server to start up, or after waiting for the time-out of the start-up wait time.
No operable group exists in the server.	Check if there is any group that is operable in the server which requested the process.

Message	Cause/Solution
The group has already been started on the local server.	Check the status of the group by using the WebManager or the <code>clpstat</code> command.
The group has already been started on the other server. To start/stop the group on the local server, use <code>-f</code> option.	Check the status of the group by using the WebManager or the <code>clpstat</code> command. If you want to start up or stop a group which was started in a remote server from the local server, move the group or run the command with the <code>-f</code> option.
The group has already been started on the other server. To move the group, use <code>"-h &lt;hostname&gt;"</code> option.	Check the status of the group by using the WebManager or <code>clpstat</code> command. If you want to move a group which was started on a remote server, run the command with the <code>-h hostname</code> option.
The group has already been stopped.	Check the status of the group by using the WebManager or the <code>clpstat</code> command.
Failed to start one or more group resources. Check the status of group	Check the status of group by using WebManager or the <code>clpstat</code> command.
Failed to stop one or more group resources. Check the status of group	Check the status of group by using the WebManager or the <code>clpstat</code> command.
The group is busy. Try again later.	Wait for a while and then try again because the group is now being started up or stopped.
An error occurred on one or more groups. Check the status of group	Check the status of the group by using the WebManager or the <code>clpstat</code> command.
Invalid group name. Specify a valid group name in the cluster.	Specify the valid name of a group in the cluster.
Server is not in a condition to start group or any critical monitor error is detected.	Check the status of the server by using the WebManager or <code>clpstat</code> command. An error is detected in a critical monitor on the server on which an attempt was made to start a group.
There is no appropriate destination for the group. Other servers are not in a condition to start group or any critical monitor error is detected.	Check the status of the server by using the WebManager or <code>clpstat</code> command. An error is detected in a critical monitor on all other servers.
The group has been started on the other server. To migrate the group, use <code>"-h &lt;hostname&gt;"</code> option.	Check the status of the group by using the WebManager or <code>clpstat</code> command. If you want to move a group which was started on a remote server, run the command with the <code>-h hostname</code> option.
The specified group cannot be migrated.	The specified group cannot be migrated.
The specified group is not vm group.	The specified group is not a virtual machine group.
Migration resource does not exist.	Check the status of the group by using the WebManager or <code>clpstat</code> command. The resource to be migrated is not found.
Migration resource is not started.	Check the status of the group by using the WebManager or <code>clpstat</code> command. The resource to be migrated is not started.
Some invalid status. Check the status of cluster.	Invalid status for some sort of reason. Check the status of the cluster.

---

<b>Message</b>	<b>Cause/Solution</b>
Internal error. Check if memory or OS resources are sufficient.	Check to see if the memory or OS resource is sufficient.

## Collecting logs (clplogcc command)

**clplogcc:** the `clplogcc` command collects logs.

### Command line

```
clplogcc [ [-h hostname] | [-n targetnode1 -n targetnode2 .....] ]
        [-t collect_type] [-r syslog_rotate_number] [-o path] [-l]
```

<b>Description</b>	This command collects information including logs and the OS information by accessing the data transfer server.	
<b>Option</b>	None	Collects logs in the cluster.
	<code>-h <i>hostname</i></code>	Specifies the name of the access destination server for collecting cluster node information
	<code>-t <i>collect_type</i></code>	Specifies a log collection pattern. When this option is omitted, a log collection pattern will be <code>type1</code> . Information on log collection types is provided in the next section.
	<code>-r <i>syslog_rotate_number</i></code>	Specifies how many generations of syslog will be collected. When this option is omitted, only one generation will be collected.
	<code>-o <i>path</i></code>	Specifies the output destination of collector files. When this option is skipped, logs are output under <code>tmp</code> of the installation path.
	<code>-n <i>targetnode</i></code>	Specifies the name of a server that collects logs. With this specification, logs of the specified server, rather than of the entire cluster, will be collected.
	<code>-l</code>	Collects logs on the local server without going through the data transfer server. The <code>-h</code> option and the <code>-n</code> option cannot be specified at the same time.
<b>Return Value</b>	0	Success
	Other than 0	Failure
<b>Remarks</b>	Since log files are compressed by <code>tar.gz</code> , add the <code>xzf</code> option to the <code>tar</code> command to decompress them.	

**Notes**

Run this command as the root user.

For the name of server for the `-h` option, specify the name of a server in the cluster that allows name resolution.

For the name of server for the `-n` option, specify the name of server that allows name resolution. If name resolution is not possible, specify the interconnect or public LAN address.

When you run this command, access the servers in the cluster in the order below, and use one of the paths that allowed successful access.

1. via the IP address on the interconnect LAN
2. via the IP address on the public LAN
3. via the IP address whose name was resolved by the server name in the cluster configuration data

**Example of command execution**

**Example 1:** Collecting logs from all servers in the cluster

```
# clplogcc
```

```
Collect Log server1 : Success
```

```
Collect Log server2 : Success
```

Log collection results (server status) of servers on which log collection is executed are displayed.

Process *hostname*: result of loc collection (server status)

**Execution Result**

For this command, the following processes are displayed.

Steps in Process	Meaning
Connect	Displayed when the access fails.
Get File size	Displayed when acquiring the file size fails.
Collect Log	Displayed with the file acquisition result.

The following results (server status) are displayed:

Result (server status)	Meaning
Success	Success
Timeout	Time-out occurred.
Busy	The server is busy.
Not Exist File	The file does not exist.
No Free space	No free space on the disk.
Failed	Failure caused by other errors.

**Error Message**

<b>Message</b>	<b>Cause/Solution</b>
Log in as root.	Log on as the root user.
Invalid configuration file. Create valid cluster configuration data by using the Builder.	Create valid cluster configuration data using the Builder.
Invalid option.	Specify a valid option.
Specify a number in a valid range.	Specify a number within a valid range.
Specify a correct number.	Specify a valid number.
Specify correct generation number of syslog.	Specify a valid number for the syslog generation.
Collect type must be specified 'type1' or 'type2' or 'type3'. Incorrect collection type is specified.	Invalid collection type has been specified.
Specify an absolute path as the destination of the files to be collected.	Specify an absolute path for the output destination of collected files.
Specifiable number of servers are the max number of servers that can constitute a cluster.	The number of servers you can specify is within the maximum number of servers for cluster configuration.
Could not connect to the server. Check if the cluster daemon is active.	Check if the cluster daemon is activated.
Failed to obtain the list of nodes. Specify a valid server name in the cluster.	Specify the valid name of a server in the cluster.
Invalid server status.	Check if the cluster daemon is activated.
Server is busy. Check if this command is already run.	This command may have been already activated. Check the status.
Internal error. Check if memory or OS resources are sufficient.	Check to see if the memory or OS resource is sufficient.

## Collecting logs by specifying a type (-t option)

To collect only the specified types of logs, run the `clplogcc` command with the `-t` option. Specify a type from 1 through 4 for the log collection.

	type1	type2	type3	type4
(1) Default collection information	y	y	y	y
(2) syslog	y	y	y	n
(3) core	y	y	n	y
(4) OS information	y	y	y	y
(5) script	y	y	n	n
(6) ESM/PRO/AC	y	y	n	n
(7) HA Logs	n	y	n	n

(y=yes, n=no)

Run this command from the command line as follows.

Example: When collecting logs using type2

```
# clplogcc -t type2
```

When no option is specified, a log type will be type 1.

(1) Information to be collected by default

Information on the following is collected by default:

- Logs of each module in the EXPRESSCLUSTER Server
- Alert logs
- Attribute of each module (`ls -l`) in the EXPRESSCLUSTER Server
  - In bin, lib
  - In cloud
  - In alert/bin, webmgr/bin
  - In ha/jra/bin, ha/sra/bin, ha/jra/lib, ha/sra/lib
  - In drivers/md
  - In drivers/khb
  - In drivers/ka
- All installed packages (`rpm -qa expresscls` execution result)
- EXPRESSCLUSTER version
- distribution (`/etc/*-release`)
- CPU license and node license
- Cluster configuration data file
- Policy file
- Cloud environment configuration directory
- Dump of shared memory used by EXPRESSCLUSTER
- Local node status of EXPRESSCLUSTER (`clpstat --local` execution results)
- Process and thread information (`ps` execution result)
- PCI device information (`lspci` execution result)

- Service information (execution results of the commands such as `systemctl`, `chkconfig`, and `ls`)
- Output result of kernel parameter (result of running `sysctl -a`)
- glibc version (`rpm -qi glibc` execution result)
- Kernel loadable module configuration (`/etc/modules.conf`, `/etc/modprobe.conf`)
- File system (`/etc/fstab`)
- IPC resource (`ipcs` execution result)
- System (`uname -a` execution result)
- Network statistics (`netstat`, `ss` execution result IPv4/IPv6)
- `ip` (execution results of the command `ip addr`, `link`, `maddr`, `route` or `-s l`)
- All network interfaces (`ethtool` execution result)
- Information collected at an emergency OS shutdown (See “Collecting information ” on page 415.)
- libxml2 version (`rpm -qi libxml2` execution result)
- Static host table (`/etc/hosts`)
- File system export table (`exportfs -v` execution result)
- User resource limitations (`ulimit -a` execution result)
- File system exported by kernel-based NFS (`/etc/exports`)
- OS locale
- Terminal session environment value (`export` execution result)
- Language locale (`/etc/sysconfig/i18n`)
- Time zone (`env -date` execution result)
- Work area of EXPRESSCLUSTER server
- Monitoring options  
This information is collected if options are installed.
- Collected dump information when the monitor resource timeout occurred
- Collected Oracle detailed information when Oracle monitor resource abnormality was detected

### (2) syslog

- `syslog` (`/var/log/messages`)
- `syslog` (`/var/log/syslog`)
- Syslogs for the number of generations specified (`/var/log/messages.x`)
- journal log (such as files in `/var/run/log/journal/`)

### (3) core file

- core file of EXPRESSCLUSTER module  
Stored in `/opt/nec/clusterpro/log` by the following archive names.

Alert related:

`alyyyyymmdd_x.tar`

The WebManager related:

`wmyyyyyymmdd_x.tar`

EXPRESSCLUSTER core related:

`clsyyyyymmdd_x.tar`



`srayyyymmdd_x.tar`

`jrayyyymmdd_x.tar`

`yyyyymmdd` indicates the date when the logs are collected. `x` is a sequence number.

#### (4) OS information

OS information on the following is collected by default:

- Kernel mode LAN heartbeat, keep alive
  - `/proc/khb_moninfo`
  - `/proc/ka_moninfo`
- `/proc/devices`
- `/proc/mdstat`
- `/proc/modules`
- `/proc/mounts`
- `/proc/meminfo`
- `/proc/cpuinfo`
- `/proc/partitions`
- `/proc/pci`
- `/proc/version`
- `/proc/ksyms`
- `/proc/net/bond*`
- all files of `/proc/scsi/` all files in the directory
- all files of `/proc/ide/` all files in the directory
- `/etc/fstab`
- `/etc/rc*.d`
- `/etc/syslog.conf`
- `/etc/syslog-ng/syslog-ng.conf`
- `/etc/snmp/snmpd.conf`
- Kernel ring buffer (dmesg execution result)
- ifconfig (the result of running ifconfig)
- iptables (the result of running iptables -L)
- ipchains (the result of running ipchains -L)
- df (the result of running df)
- raw device information (the result of running raw -qa)
- kernel module load information (the result of running lsmod)
- host name, domain name information (the result of running hostname, domainname)
- dmidecode (the result of running dmidecode)
- LVM device information (the result of running vgdisplay -v)
- snmpd version information (snmpd -v execution result)
- Virtual Infrastructure information (the result of running virt-what)
- blockdev (the result of running blockdev --report)

When you collect logs, you may find the following message on the console. This does not mean failure. The logs are collected normally.

```
hd#: bad special flag: 0x03
ip_tables: (C) 2000-2002 Netfilter core team
(Where hd# is the name of the IDE device that exists on the server)
```

**(5) Script**

Start/stop script for a group that was created with the Builder.

If you specify a user-defined script other than the above (/opt/nec/clusterpro/scripts), it is not included in the log collection information. It must be collected separately.

**(6) ESM/PRO/AC Related logs**

Files that are collected by running the `acupslog` command.

**(7) HA logs**

- System resource information
- JVM monitor log
- System monitor log

## Syslog generations (`-r` option)

To collect syslogs for the number of generations specified, run the following command.

Example: Collecting logs for the 3 generations

```
# clplogcc -r 3
```

The following syslogs are included in the collected logs.

```
/var/log/messages
/var/log/messages.1
/var/log/messages.2
```

- ◆ When no option is specified, only /var/log/messages is collected.
- ◆ You can collect logs for 0 to 99 generations.
- ◆ When 0 is specified, all syslogs are collected.

Number of Generation	Number of generations to be acquired
0	All Generations
1	Current
2	Current + Generation 1
3	Current + Generation 1 to 2
:	
:	
x	Current + Generation 1 to (x-1)

## Output paths of log files (`-o` option)

- ◆ Log file is named and be saved as “*server name*-log.tar.gz”
- ◆ If an IP address is specified for the `-n` option, a log file is named and saved as “*IP address*-log.tar.gz.”
- ◆ Since log files are compressed by `tar.gz`, decompress them by adding the `xzf` option to the `tar` command.

### If not specifying `-o` option

Logs are output in tmp of installation path.

```
# clplogcc
Collect Log hostname : Success
# ls /opt/nec/clusterpro/tmp
hostname-log.tar.gz
```

#### When the `-o` option is not specified:

If you run the command as follows, logs are located in the specified `/home/log` directory.

```
# clplogcc -o /home/log
Collect Log hostname: Success
# ls /home/log
hostname-log.tar.gz
```

## Specifying log collector server (`-n` option)

By using the `-n` option, you can collect logs only from the specified server.

Example: Collecting logs from Server1 and Server3 in the cluster.

```
# clplogcc -n Server1 -n Server3
```

- ◆ Specify a server in the same cluster.
- ◆ The number of servers you can specify is within the maximum number of servers in the cluster configuration.

## Collecting information when a failure occurs

When the following failure occurs, the information for analyzing the failure is collected.

- ◆ When a cluster daemon configuring the cluster abnormally terminates due to interruption by a signal (core dump) or internal status error etc.
- ◆ When a group resource activation error or deactivation error occurs
- ◆ When monitoring error occurs in a monitor resource

Information to be collected is as follows:

- ◆ Cluster information
  - Some module logs in EXPRESSCLUSTER servers
  - Dump files in the shared memory used by EXPRESSCLUSTER
  - Cluster configuration information files
  - Core files of EXPRESSCLUSTER module
- ◆ OS information (`/proc/*`)
  - `/proc/devices`
  - `/proc/partitions`
  - `/proc/mdstat`
  - `/proc/modules`
  - `/proc/mounts`

- `/proc/meminfo`
- `/proc/net/bond*`
- ◆ Information created by running a command
  - Results of the `sysctl -a`
  - Results of the `ps`
  - Results of the `top`
  - Results of the `ipcs`
  - Results of the `netstat -in`
  - Results of the `netstat -apn`
  - Results of the `netstat -gn`
  - Results of the `netstat -rn`
  - Results of the `ifconfig`
  - Results of the `ip addr`
  - Results of the `ip -s 1`
  - Results of the `df`
  - Results of the `raw -qa`
  - `journalctl -e` execution result

These are collected by default in the log collection. You do not need to collect them separately.

## Changing, backing up, and checking cluster configuration data (clpcfctrl command)

### Creating a cluster and changing the cluster configuration data

**clpcfctrl --push:** the `clpcfctrl --push` command delivers cluster configuration data to servers.

#### Command line

```
clpcfctrl --push -l|-w [-c hostname|IP] [-h hostname|IP] [-p
portnumber]
                    [-x directory] [--force] [--nocheck]
```

<b>Description</b>	This command delivers the configuration data created by the Builder to servers.	
<b>Option</b>	<code>--push</code>	Specify this option when delivering the data. You cannot omit this option.
	<code>-l</code>	Specify this option when using the floppy disk with the data saved by the Builder on Linux. If you use the floppy disk with the data saved in the Windows format by the Builder on Linux, specify <code>-w</code> .  You cannot specify <code>-l</code> and <code>-w</code> together.
	<code>-w</code>	Specify this option when using the floppy disk with the data saved by the Builder on Windows. When you use the floppy disk with the data saved for Windows with the Builder on Linux, use this option as well.  You cannot specify <code>-l</code> and <code>-w</code> together.
	<code>-c</code> <i>hostname IP</i>	Specifies a server to access for acquiring a list of servers. Specify a host name or IP address.  When this option is omitted, configuration data in the floppy disk will be used.
	<code>-h</code> <i>hostname IP</i>	Specifies a server to which configuration data is delivered. Specify host name or IP address.  If this option is omitted, configuration data is delivered to all servers.
	<code>-p</code> <i>portnumber</i>	Specifies a port number of data transfer port.  When this option is omitted, the default value will be used.  In general, it is not necessary to specify this option.

`-x` Use this option only in an environment where floppy disks cannot be used.

`directory` Specify this option when delivering configuration data to the specified directory.

This option is used with `-l` or `-w`.

When `-l` is specified, configuration data saved on the file system by the Builder on Linux is used.

When `-w` is specified, configuration data saved by the Builder on Windows is used.

`--force` Even if there is a server that has not started, the configuration data is delivered forcefully.

`--nocheck` When this option is specified, cluster configuration data is not checked. Use this option only when deleting a server.

**Return Value**

0	Success
Other than 0	Failure

**Notes**

Run this command as the root user.

When you run this command, access the servers in the order below, and use one of the paths that allowed successful access.

1. via the IP address on the interconnect LAN
2. via the IP address on the public LAN

**Example of  
command  
execution**

**Example 1:** Generating a cluster from the floppy disk with the data saved by the Builder on Linux

```
# clpcfctrl --push -l
file delivery to server 10.0.0.11 success.
file delivery to server 10.0.0.12 success.
The upload is completed successfully.(cfmgr:0)
Command succeeded.(code:0)
```

**Example 2:** Delivering configuration data from the floppy disk with the data saved by the Builder on Windows to a specified server

```
# clpcfctrl --push -w -h 10.0.0.11
The upload is completed successfully.(cfmgr:0)
Command succeeded.(code:0)
```

**Example 3:** Delivering configuration data that was saved on the file system using the Builder on Linux

```
# clpcfctrl --push -l -x /mnt/config
file delivery to server 10.0.0.11 success.
file delivery to server 10.0.0.12 success.
The upload is completed successfully.(cfmgr:0)
Command succeeded.(code:0)
```

**Example 4:** Delivering the configuration data to the server which has been reinstalled.

```
# clpcfctrl --push -h server2
The upload is completed successfully.(cfmgr:0)
Command succeeded.(code:0)
```

**Error Message**

<b>Message</b>	<b>Cause/Solution</b>
Log in as root.	Log on as the root user.
This command is already run.	This command has been already started.
Invalid option.	The option is invalid. Check the option.
Invalid mode. Check if -push is specified.	Check if the <code>--push</code> option is specified.
The target directory does not exist.	The specified directory is not found.
Invalid host name. Server specified by -h option is not included in the configuration data	The server specified with <code>-h</code> is not included in configuration data. Check if the specified server name or IP address is valid.
Canceled.	Displayed when anything other than "y" is entered for command inquiry.
Failed to initialize the xml library. Check if memory or OS resources are sufficient.	Check if the memory or OS resource is sufficient.
Failed to load the configuration file. Check if memory or OS resources are sufficient.	
Failed to change the configuration file. Check if memory or OS resources are sufficient.	
Failed to load the policy files. Reinstall the RPM.	Reinstall the EXPRESSCLUSTER Server RPM.
Failed to load the cfctrl policy file. Reinstall the RPM.	Reinstall the EXPRESSCLUSTER Server RPM.
Failed to create a flag. This floppy disk does not contain valid data created by the Builder.	This is not the floppy disk created by using the Builder.
Failed to restart flag. This floppy disk does not contain valid data created by the Builder.	This is not the floppy disk created by using the Builder.
Failed to get the install path. Reinstall the RPM.	Reinstall the EXPRESSCLUSTER Server RPM.
Failed to get the cfctrl path. Reinstall the RPM.	Reinstall the EXPRESSCLUSTER Server RPM.
Invalid create flag value. This floppy disk does not contain valid data created by the Builder.	This is not the floppy disk created by using the Builder.
Invalid restart flag value. This floppy disk does not contain valid data created by the Builder.	This is not the floppy disk created by using the Builder.
Failed to get the list of group.	Failed to acquire the list of group.
Failed to get the list of resource.	Failed to acquire the list of resource.
Failed to initialize the trncl library. Check if memory or OS resources are sufficient.	Check to see if the memory or OS resource is sufficient.



Message	Cause/Solution
Failed to connect to server %s. Check if the other server is active and then run the command again.	Accessing the server has failed. Check if other server(s) has been started.  Run the command again after the server has started up.
Failed to connect to trnsv. Check if the other server is active.	Accessing the server has failed. Check that other server has been started up.
Failed to get the collect size.	Getting the size of the collector file has failed. Check if other server(s) has been started.
Failed to collect the file.	Collecting of the file has failed. Check if other server(s) has been started.
Failed to get the list of node. Check if the server specified by -c is a member of the cluster.	Check to see if the server specified by -c is a cluster member.
Failed to check server property. Check if the server name or ip addresses are correct by builder.	Check if the server name and the IP address in the configuration information have been set correctly.
File delivery failed. Failed to deliver the configuration data. Check if the other server is active and run the command again.	Delivering configuration data has failed. Check if other server(s) has been started.  Run the command again after the server has started up.
Multi file delivery failed. Failed to deliver the configuration data. Check if the other server is active and run the command again.	Delivering configuration data has failed. Check if other server(s) has been started.  Run the command again after the server has started up.
Failed to deliver the configuration data. Check if the other server is active and run the command again.	Delivering configuration data has failed. Check if other server(s) has been started.  Run the command again after the server has started up.
The directory "/work" is not found. Reinstall the RPM.	Reinstall the EXPRESSCLUSTER Server RPM.
Failed to make a working directory.	Check to see if the memory or OS resource is sufficient.
The directory does not exist.	
This is not a directory.	
The source file does not exist.	
The source file is a directory.	
The source directory does not exist.	
The source file is a directory.	
The source directory does not exist.	
The source file is not a directory.	
Failed to change the character code set (EUC to SJIS).	
Failed to change the character code set (SJIS to EUC).	
Command error.	

Message	Cause/Solution
<p>Failed to mount the floppy disk. Check if it is inserted.</p> <p>When using the Builder on Linux, check if the disk is saved for Windows.</p> <p>Also, check if mount point exists.</p> <p>When supermount service is running, stop the service or use -m option.</p>	<p>Mounting the floppy disk has failed. Check if the floppy disk has been inserted. If the Builder is used on Linux, check if the data was saved in the Windows format.</p> <p>Check whether the mount point exists.</p> <p>When the supermount service is operating, stop it or use the <code>-m</code> option.</p>
<p>Failed to unmount the floppy disk. Check if it is inserted.</p>	<p>Unmounting the floppy disk has failed. Check that the floppy disk has been inserted.</p>
<p>Command (tar -xf) failed. Check if the floppy disk is inserted.</p> <p>When using the Builder on Linux, check if the disk is saved for Linux.</p>	<p>Loading from the floppy disk has failed. Check if the floppy disk has been inserted. If the Builder is on Linux, check if the data was saved in the Linux format.</p>
<p>Floppy device was already mounted. Umount the floppy disk, and then perform operations.</p>	<p>The floppy device was already mounted. Unmount the floppy disk, and then operate it again.</p>
<p>Failed to mount the floppy disk. Check if mount point exists.</p>	<p>Failed to mount the floppy disk. Make sure that the mount point exists.</p>
<p>Failed to initialize the cfmgr library. Check if memory or OS resources are sufficient.</p>	<p>Check to see if the memory or OS resource is sufficient.</p>
<p>Failed to get size from the cfmgr library. Check if memory or OS resources are sufficient.</p>	<p>Check to see if the memory or OS resource is sufficient.</p>
<p>Failed to allocate memory.</p>	<p>Check to see if the memory or OS resource is sufficient.</p>
Failed to change the directory.	
Failed to run the command.	
Failed to make a directory.	
Failed to remove the directory.	
Failed to remove the file.	
Failed to open the file.	
Failed to read the file.	
Failed to write the file.	
<p>Internal error. Check if memory or OS resources are sufficient.</p>	
<p>The upload is completed successfully. To start the cluster, refer to "How to create a cluster" in the Installation and Configuration Guide.</p>	<p>The upload is successfully completed. To start the cluster, refer to Chapter 5 "Creating the cluster configuration data" in the <i>Installation and Configuration Guide</i>.</p>
<p>The upload is completed successfully. To apply the changes you made, shutdown and reboot the cluster.</p>	<p>The upload is successfully completed. To apply the changes you made, shut down the cluster, and reboot it.</p>

Changing, backing up, and checking cluster configuration data (clpcctrl command)

Message	Cause/Solution
The upload was stopped. To upload the cluster configuration data, stop the cluster.	The upload was stopped. To upload the cluster configuration data, stop the cluster.
The upload was stopped. To upload the cluster configuration data, stop the Mirror Agent.	The upload was stopped. To upload the cluster configuration data, stop the Mirror Agent.
The upload was stopped. To upload the cluster configuration data, stop the resources to which you made changes.	The upload was stopped. To upload the cluster configuration data, stop the resources to which you made changes.
The upload was stopped. To upload the cluster configuration data, stop the groups to which you made changes.	The upload was stopped. To upload the cluster configuration data, suspend the cluster. To upload, stop the group to which you made changes.
The upload was stopped. To upload the cluster configuration data, suspend the cluster.	The upload was stopped. To upload the cluster configuration data, suspend the cluster.
The upload is completed successfully. To apply the changes you made, restart the Alert Sync. To apply the changes you made, restart the WebManager.	The upload is completed successfully. To apply the changes you made, restart the Alert Sync. To apply the changes you made, restart the WebManager service.
Internal error. Check if memory or OS resources are sufficient.	Check to see if the memory or OS resource is sufficient.
The upload is completed successfully.	The upload is successfully completed.
The upload was stopped. Failed to deliver the configuration data. Check if the other server is active and run the command again.	The upload was stopped. Failed to deliver the configuration data. Check if the other server is active and run the command again.
The upload was stopped. There is one or more servers that cannot be connected to. To apply cluster configuration information forcibly, run the command again with "--force" option.	The upload was stopped. The server that cannot connect exists. To forcibly upload the cluster configuration information, run the command again with the <code>-force</code> option.

## Backing up the Cluster configuration data

`clpcfctrl --pull`: the `clpcfctrl --pull` command backs up cluster configuration data.

### Command line

```
clpcfctrl --pull -l|-w [-h hostname|IP] [-p portnumber]
[-x directory]
```

<b>Description</b>	This command backs up cluster configuration data to be used for the Builder.	
<b>Option</b>	<code>--pull</code>	Specify this option when performing backup. You cannot omit this option.
	<code>-l</code>	Specify this option when backing up data to the floppy disk that is used for the Builder on Linux. You cannot specify both <code>-l</code> and <code>-w</code> together.
	<code>-w</code>	Specify this option when backing up data to the floppy disk that is used for the Builder on Windows. The floppy disk must be formatted by 1.44 MB (VFAT). You cannot specify both <code>-l</code> and <code>-w</code> together.
	<code>-h</code> <i>hostname IP</i>	Specifies the source server for backup. Specify a host name or IP address. When this option is omitted, the configuration data on the server running the command is used.
	<code>-p</code> <i>portnumber</i>	Specifies a port number of data transfer port. When this option is omitted, the default value is used. In general, it is not necessary to specify this option.
	<code>-x</code> <i>directory</i>	Used only in an environment where floppy disks cannot be used. Backs up the configuration data in the specified directory. Use this option with either <code>-l</code> or <code>-w</code> . When <code>-l</code> is specified, configuration data is backed up in the format which can be loaded by the Builder on Linux. When <code>-w</code> is specified, configuration data is saved in the format which can be loaded by the Builder on Windows.
<b>Return Value</b>	0	Success
	Other than 0	Failure
<b>Notes</b>	Run this command as the root user. When you run this command, access the servers in the cluster in the order below, and use one of the paths that allowed successful access. 1. via the IP address on the interconnect LAN	

2. via the IP address on the public LAN

**Example of  
command  
execution**

**Example 1:** Backing up on the floppy disk that is used by the Builder on Linux

```
# clpcfctrl --pull -l  
Command succeeded.(success.(code:0))
```

**Example 2:** Backing up configuration information about the specified server to the floppy disk that is used by the Builder on Windows

```
# clpcfctrl --pull -w -h 10.0.0.11  
Command succeeded.(success.(code:0))
```

**Example 3:** Backing up configuration data to the specified directory so that the data can be loaded by the Builder on Linux

```
# clpcfctrl --pull -l -x /mnt/config  
Command succeeded.(code:0)
```

**Error Message**

<b>Message</b>	<b>Cause/Solution</b>
Log in as root.	Log on as the root user.
This command is already run.	This command has been already started.
Invalid option.	The option is invalid. Check the option.
Invalid mode. Check if --push or --pull option is specified.	Check to see if the --pull is specified. .
The target directory does not exist.	The specified directory does not exist.
Canceled.	Displayed when anything other than "y" is entered for command inquiry.
Failed to initialize the xml library. Check if memory or OS resources are sufficient.	Check to see if the memory or OS resource is sufficient.
Failed to load the configuration file. Check if memory or OS resources are sufficient.	
Failed to change the configuration file. Check if memory or OS resources are sufficient.	
Failed to load the all.pol file. Reinstall the RPM	Reinstall the EXPRESSCLUSTER Server RPM.
Failed to load the cfctrl.pol file. Reinstall the RPM	Reinstall the EXPRESSCLUSTER Server RPM.
Failed to get the install path. Reinstall the RPM.	Reinstall the EXPRESSCLUSTER Server RPM.
Failed to get the cfctrl path. Reinstall the RPM.	Reinstall the EXPRESSCLUSTER Server RPM
Failed to initialize the trncl library. Check if memory or OS resources are sufficient.	Check to see if the memory or OS resource is sufficient.
Failed to connect to server %1. Check if the other server is active and then run the command again.	Accessing the server has failed. Check if other server(s) has been started. Run the command again after the server has started up.
Failed to connect to trnsv. Check if the other server is active.	Accessing the server has failed. Check if other server(s) has been started.
Failed to get configuration data. Check if the other server is active.	Acquiring configuration data has failed. Check if other(s) server has been started.
The directory "/work" is not found. Reinstall the RPM.	Reinstall the EXPRESSCLUSTER Server RPM
Failed to make a working directory. The directory does not exist. This is not a directory.	Check to see if the memory or OS resource is sufficient.

Message	Cause/Solution
The source file does not exist.	
The source file is a directory.	
The source directory does not exist.	
The source file is not a directory.	
Failed to change the character code set (EUC to SJIS).	
Failed to change the character code set (SJIS to EUC).	
Command error.	
Failed to mount the floppy disk. Check if it is inserted. When using the Builder on Linux, check if the disk is saved for Windows. Also, check if mount point exists. When supermount service is running, stop the service or use -m option.	Mounting the floppy disk has failed. Check if the floppy disk has been inserted. If the Builder is used on Linux, check if the data was saved in the Windows format.  Check whether the mount point exists.  When the supermount service is operating, stop it or use the <code>-m</code> option.
Failed to unmount the floppy disk. Check if it is inserted.	Unmounting the floppy disk has failed. Check if the floppy disk has been inserted.
Command (tar <code>-cf</code> ) failed. Check if the floppy disk is inserted.	Failed to back up the floppy device. Check if the floppy disk has been inserted.
Floppy device was already mounted. Unmount the floppy disk, and then perform operations.	Floppy device was already mounted. Unmount the floppy disk, and then perform operations.
Failed to mount the floppy disk. Check if mount point exists.	Failed to mount the floppy device. Check that the mount point exists.
Failed to initialize the cfmgr library. Check if memory or OS resources are sufficient.	Check to see if the memory or OS resource is sufficient.
Failed to get size from the cfmgr library. Check if memory or OS resources are sufficient.	Check to see if the memory or OS resource is sufficient.
Failed to allocate memory.	Check to see if the memory or OS resource is sufficient.
Failed to change the directory.	
Failed to run the command.	
Failed to make a directory.	
Failed to remove the directory.	
Failed to remove the file.	
Failed to open the file.	
Failed to read the file.	
Failed to write the file.	
Internal error. Check if memory or OS resources are sufficient.	Check to see if the memory or OS resource is sufficient.

## Adding a resource without stopping the group

**clpcfctrl --dpush:** the `clpcfctrl --dpush` command adds a resource without stopping the group.

### Command line

```
clpcfctrl --dpush -l|-w [-c hostname|IP] [-p portnumber]
                    [-x directory] [--force]
```

**Description** This command dynamically adds a resource without stopping the group.

<b>Option</b>	<b>--dpush</b>	Specify this option when dynamically adding a resource.  You cannot omit this option.
	<b>-l</b>	Specify this option when using the floppy disk with the data saved by the Builder on Linux. If you use the floppy disk with the data saved in the Windows format by the Builder on Linux, specify -w.  You cannot specify -l and -w together.
	<b>-w</b>	Specify this option when using the floppy disk with the data saved by the Builder on Linux. If you use the floppy disk with the data saved in the Windows format by the Builder on Linux, specify -w.  You cannot specify -l and -w together.
	<b>-c <i>hostname IP</i></b>	Specifies a server to access for acquiring a list of servers. Specify a host name or IP address.  When this option is omitted, configuration data in the floppy disk will be used.
	<b>-p <i>portnumber</i></b>	Specifies a port number of data transfer port.  When this option is omitted, the default value will be used. In general, it is not necessary to specify this option.
	<b>-x <i>directory</i></b>	Use this option only in an environment where floppy disks cannot be used.  Specify this option when delivering configuration data to the specified directory.  This option is used with -l or -w.  When -l is specified, configuration data saved on the file system by the Builder on Linux is used.  When -w is specified, configuration data saved by the Builder on Windows is used.
	<b>--force</b>	Even if there is a server that has not started, the configuration data is delivered forcefully.
<b>Return Value</b>	<b>0</b>	Success



Other than 0      Failure

**Notes**

Run this command as the root user.

When you run this command, access the servers in the order below, and use one of the paths that allowed successful access.

1. via the IP address on the interconnect LAN
2. via the IP address on the public LAN

For details on resources that support dynamic resource addition, refer to “How to add a resource without stopping the group” in “Chapter 10 The system maintenance information”.

To use this command, the internal version of EXPRESSCLUSTER of all the nodes in the cluster must be 3.2.1-1 or later.

While the dynamic resource addition command is running, do not resume the command. Otherwise, the cluster configuration data may become inconsistent, and the cluster may stop or the server may shut down.

If you abort the dynamic resource addition command, the activation status of the resource to be added may become undefined. In this case, run the command again or reboot the cluster manually.

**Example of command execution**

**Example 1:** Dynamically adding a resource from the floppy disk with the data saved by the Builder on Linux

```
# clpcfctrl --dpush -l
file delivery to server 10.0.0.11 success.
file delivery to server 10.0.0.12 success.

The upload is completed successfully.(cfmgr:0)

Command succeeded.(code:0)
```

**Example 2:** Dynamically adding a resource using configuration data that was saved on the file system using the Builder on Linux

```
# clpcfctrl --dpush -l -x /mnt/config
file delivery to server 10.0.0.11 success.
file delivery to server 10.0.0.12 success.

The upload is completed successfully.(cfmgr:0)

Command succeeded.(code:0)
```

**Error Message**

Message	Cause/Solution
Log in as root.	Log on as the root user.
This command is already run.	This command has been already started.
Invalid option.	The option is invalid. Check the option.
Invalid mode. Check if --push or --pull option is specified.	Check if the --push option is specified.
The target directory does not exist.	The specified directory is not found.

Message	Cause/Solution
Invalid host name. Server specified by -h option is not included in the configuration data.	The server specified with -h is not included in configuration data. Check if the specified server name or IP address is valid.
Canceled.	Displayed when anything other than "y" is entered for command inquiry.
Failed to initialize the xml library. Check if memory or OS resources are sufficient.	Check if the memory or OS resource is sufficient.
Failed to load the configuration file. Check if memory or OS resources are sufficient.	
Failed to change the configuration file. Check if memory or OS resources are sufficient.	
Failed to load the all.pol file. Reinstall the RPM.	Reinstall the EXPRESSCLUSTER Server RPM.
Failed to load the cfctrl.pol file. Reinstall the RPM.	Reinstall the EXPRESSCLUSTER Server RPM.
Failed to get a create flag. This floppy disk does not contain valid data created by the Builder.	This is not the floppy disk created by using the Builder.
Failed to get a restart flag. This floppy disk does not contain valid data created by the Builder.	This is not the floppy disk created by using the Builder.
Failed to get the install path. Reinstall the RPM.	Reinstall the EXPRESSCLUSTER Server RPM.
Failed to get the cfctrl path. Reinstall the RPM.	Reinstall the EXPRESSCLUSTER Server RPM.
Invalid create flag value. This floppy disk does not contain valid data created by the Builder.	This is not the floppy disk created by using the Builder.
Invalid restart flag value. This floppy disk does not contain valid data created by the Builder.	This is not the floppy disk created by using the Builder.
Failed to get the list of group.	Failed to acquire the list of groups.
Failed to get the list of resource.	Failed to acquire the list of resources.
Failed to initialize the trncl library. Check if memory or OS resources are sufficient.	Check to see if memory or OS resource is sufficient.
Failed to connect to server %1. Check if the other server is active and then run the command again.	Accessing the server has failed. Check if other server(s) has been started.  Run the command again after the server has started up.
Failed to connect to trnsv. Check if the other server is active.	Accessing the server has failed. Check if other server(s) has been started up.
Failed to get the collect size.	Getting the size of the collector file has failed. Check if other server(s) has been started.
Failed to collect the file.	Collecting the file has failed. Check if other server(s) has been started.
Failed to check server property. Check if the server name or ip addresses are correct by builder.	Check if the server name and the IP address in the configuration information have been set correctly.

Message	Cause/Solution
File delivery failed. Failed to deliver the configuration data. Check if the other server is active and run the command again.	Delivering configuration data has failed. Check if other server(s) has been started.  Run the command again after the server has started up.
Multi file delivery failed. Failed to deliver the configuration data. Check if the other server is active and run the command again.	Delivering configuration data has failed. Check if other server(s) has been started.  Run the command again after the server has started up.
Failed to deliver the configuration data. Check if the other server is active and run the command again.	Delivering configuration data has failed. Check if other server(s) has been started.  Run the command again after the server has started up.
The directory "work" is not found. Reinstall the RPM.	Reinstall the EXPRESSCLUSTER Server RPM.
Failed to make a working directory.	Check if the memory or OS resource is sufficient.
The directory does not exist.	
This is not a directory.	
The source file does not exist.	
The source file is a directory.	
The source directory does not exist.	
The source file is not a directory.	
Failed to change the character code set (EUC to SJIS).	
Failed to change the character code set (SJIS to EUC).	
Command error.	
Failed to mount the floppy disk. Check if it is inserted. When using the Builder on Linux, check if the disk is saved for Windows. Also, check if mount point exists. When supermount service is running, stop the service or use -m option.	Mounting the floppy disk has failed. Check if the floppy disk has been inserted. If the Builder is used on Linux, check if the data was saved in the Windows format.  Check whether the mount point exists.  When the supermount service is operating, stop it or use the -m option.
Failed to umount the floppy disk. Check if it is inserted.	Unmounting the floppy disk has failed. Check that the floppy disk has been inserted.
Command (tar -xf) failed. Check if the floppy disk is inserted. When using the Builder on Linux, check if the disk is saved for Linux.	Loading from the floppy disk has failed. Check if the floppy disk has been inserted. If the Builder is used on Linux, check if the data was saved in the Linux format.
Floppy device was already mounted. Unmount the floppy disk, and then perform operations.	The floppy device was already mounted. Unmount the floppy disk, and then operate it again.
Failed to mount the floppy disk. Check if mount point exists.	Failed to mount the floppy disk. Check if the mount point exists.
Failed to initialize the cfmgr library. Check if memory or OS resources are sufficient.	Check if the memory or OS resource is sufficient.
Failed to get size from the cfmgr library. Check if memory or OS resources are sufficient.	Check if the memory or OS resource is sufficient.
Failed to allocate memory.	Check if the memory or OS resource is sufficient.
Failed to change the directory.	
Failed to run the command.	
Failed to make a directory.	

Message	Cause/Solution
Failed to remove the directory.	
Failed to remove the file.	
Failed to open the file.	
Failed to read the file.	
Failed to write the file.	
Internal error. Check if memory or OS resources are sufficient.	Check if the memory or OS resource is sufficient.
The upload is completed successfully. To start the cluster, refer to "How to create a cluster" in the Installation and Configuration Guide.	The upload is successfully completed. To start the cluster, refer to Chapter 5, "Creating the cluster configuration data" in the Installation and Configuration Guide.
The upload is completed successfully. To apply the changes you made, shutdown and reboot the cluster.	The upload is successfully completed. To apply the changes you made, shut down the cluster, and reboot it.
The upload was stopped. To upload the cluster configuration data, stop the cluster.	The upload was stopped. To upload the cluster configuration data, stop the cluster.
The upload was stopped. To upload the cluster configuration data, stop the Mirror Agent.	The upload was stopped. To upload the cluster configuration data, stop the Mirror Agent.
The upload was stopped. To upload the cluster configuration data, stop the resources to which you made changes.	The upload was stopped. To upload the cluster configuration data, stop the resource to which you made changes.
The upload was stopped. To upload the cluster configuration data, stop the groups to which you made changes.	The upload was stopped. To upload the cluster configuration data, suspend the cluster. To upload, stop the group to which you made changes.
The upload was stopped. To upload the cluster configuration data, suspend the cluster.	The upload was stopped. To upload the cluster configuration data, suspend the cluster.
The upload is completed successfully. To apply the changes you made, restart the Alert Sync. To apply the changes you made, restart the WebManager.	The upload is completed successfully. To apply the changes you made, restart the Alert Sync service. To apply the changes you made, restart the WebManager service.
The upload is completed successfully.	The upload is successfully completed.
The upload was stopped. Failed to deliver the configuration data. Check if the other server is active and run the command again.	The upload was stopped. Failed to deliver the cluster configuration data. Check if the other server is active and run the command again.
The upload was stopped. There is one or more servers that cannot be connected to. To apply cluster configuration information forcibly, run the command again with "--force" option.	The upload was stopped. The server that cannot connect exists. To forcibly upload the cluster configuration information, run the command again with the --force option.
The upload was stopped. Failed to active resource. Please check the setting of resource.	The upload was stopped. Failed to activate the resource. Check the setting of the resource.

## Checking cluster configuration data

**clpcfctrl --compcheck:** the `clpcfctrl --compcheck` command checks cluster configuration data.

### Command line

```
clpcfctrl --compcheck -l|-w [-c hostname|IP] [-p portnumber]
[-x directory]
```

**Description** This command checks whether or not cluster configuration data is correct.

<b>Option</b>	<code>--compcheck</code>	Specify this option when checking configuration data.  You cannot omit this option.
	<code>-l</code>	Specify this option when using the floppy disk with the data saved by the Builder on Linux. If you use the floppy disk with the data saved in the Windows format by the Builder on Linux, specify <code>-w</code> .  You cannot specify <code>-l</code> and <code>-w</code> together.
	<code>-w</code>	Specify this option when using the floppy disk with the data saved by the Builder on Windows. When you use the floppy disk with the data saved for Windows with the Builder on Linux, use this option as well.  You cannot specify <code>-l</code> and <code>-w</code> together.
	<code>-x directory</code>	Use this option only in an environment where floppy disks cannot be used.  Specify this option when delivering configuration data to the specified directory.  This option is used with <code>-l</code> or <code>-w</code> .  When <code>-l</code> is specified, configuration data saved on the file system by the Builder on Linux is used.  When <code>-w</code> is specified, configuration data saved by the Builder on Windows is used.
<b>Return Value</b>	0	Success
	Other than 0	Failure

**Notes** Run this command as the root user.

When you run this command, access the cluster servers in the order below, and use one of the paths that allowed successful access.

1. Via the IP address on the interconnect LAN
2. Via the IP address on the public LAN

This command finds the difference between the new and existing configuration data, and checks the resource configuration data in the added configuration data.

**Example of command execution** **Example 1:** Checking cluster configuration data of the floppy disk with the data saved by the Builder on Linux

```
# clpcfctrl --compcheck -l
```

The check is completed successfully.(cfmgr:0)

Command succeeded.(code:0)

**Example 2:** Checking configuration data that was saved on the file system using the Builder on Linux

```
# clpcfctrl --compcheck -l -x /mnt/config
```

The check is completed successfully.(cfmgr:0)

Command succeeded.(code:0)

**Error Message**

Message	Cause/Solution
Log in as root.	Log in as the root user.
This command is already run.	This command has been already started.
Invalid option.	The option is invalid. Check the option.
The target directory does not exist.	The specified directory is not found.
Canceled.	Displayed when anything other than “y” is entered for command inquiry.
Failed to initialize the xml library. Check if memory or OS resources are sufficient.	Check if the memory or OS resource is sufficient.
Failed to load the configuration file. Check if memory or OS resources are sufficient.	
Failed to change the configuration file. Check if memory or OS resources are sufficient.	
Failed to load the all.pol file. Reinstall the RPM.	Reinstall the EXPRESSCLUSTER Server RPM.
Failed to load the cfctrl.pol file. Reinstall the RPM.	Reinstall the EXPRESSCLUSTER Server RPM.
Failed to get a create flag. This floppy disk does not contain valid data created by the Builder.	This is not the floppy disk created by using the Builder.
Failed to get a restart flag. This floppy disk does not contain valid data created by the Builder.	This is not the floppy disk created by using the Builder.

Message	Cause/Solution
Failed to get the install path. Reinstall the RPM.	Reinstall the EXPRESSCLUSTER Server RPM.
Failed to get the cfctrl path. Reinstall the RPM.	Reinstall the EXPRESSCLUSTER Server RPM.
Invalid create flag value. This floppy disk does not contain valid data created by the Builder.	This is not the floppy disk created by using the Builder.
Invalid restart flag value. This floppy disk does not contain valid data created by the Builder.	This is not the floppy disk created by using the Builder.
Failed to get the list of group.	Failed to acquire the list of group.
Failed to get the list of resource.	Failed to acquire the list of resource.
Failed to initialize the trncl library. Check if memory or OS resources are sufficient.	Check if the memory or OS resource is sufficient.
Failed to connect to server %1. Check if the other server is active and then run the command again.	Accessing the server has failed. Check if other server(s) has been started. Run the command again after the server has started up.
Failed to connect to trnsv. Check if the other server is active.	Accessing the server has failed. Check that other server has been started up.
Failed to get the collect size.	Getting the size of the collector file has failed. Check if other server(s) has been started.
Failed to collect the file.	Collecting of the file has failed. Check if other server(s) has been started.
Failed to get the list of node. Check if the server specified by -c is a member of the cluster.	Check to see if the server specified by -c is a cluster member.
Failed to check server property. Check if the server name or ip addresses are correct by builder.	Check if the server name and the IP address in the configuration information have been set correctly.
File delivery failed. Failed to deliver the configuration data. Check if the other server is active and run the command again.	Delivering configuration data has failed. Check if other server(s) has been started. Run the command again after the server has started up.
Multi file delivery failed. Failed to deliver the configuration data. Check if the other server is active and run the command again.	Delivering configuration data has failed. Check if other server(s) has been started. Run the command again after the server has started up.
Failed to deliver the configuration data. Check if the other server is active and run the command again.	Delivering configuration data has failed. Check if other server(s) has been started. Run the command again after the server has started up.
The directory "work" is not found. Reinstall the RPM.	Reinstall the EXPRESSCLUSTER Server RPM.
Failed to make a working directory.	Check if the memory or OS resource is sufficient.
The directory does not exist.	
This is not a directory.	
The source file does not exist.	
The source file is a directory.	
The source directory does not exist.	
The source file is not a directory.	
Failed to change the character code set (EUC to SJIS).	
Failed to change the character code set (SJIS to EUC).	
Command error.	

Message	Cause/Solution
Failed to mount the floppy disk. Check if it is inserted. When using the Builder on Linux, check if the disk is saved for Windows. Also, check if mount point exists. When supermount service is running, stop the service or use -m option.	Mounting the floppy disk has failed. Check if the floppy disk has been inserted. If the Builder is used on Linux, check if the data was saved in the Windows format. Check whether the mount point exists. When the supermount service is operating, stop it or use the -m option.
Failed to umount the floppy disk. Check if it is inserted.	Unmounting the floppy disk has failed. Check that the floppy disk has been inserted.
Command (tar -xf) failed. Check if the floppy disk is inserted. When using the Builder on Linux, check if the disk is saved for Linux.	Loading from the floppy disk has failed. Check if the floppy disk has been inserted. If the Builder is on Linux, check if the data was saved in the Linux format.
Floppy device was already mounted. Umount the floppy disk, and then perform operations.	The floppy device was already mounted. Unmount the floppy disk, and then operate it again.
Failed to mount the floppy disk. Check if mount point exists.	Failed to mount the floppy disk. Make sure that the mount point exists.
Failed to initialize the cfmgr library. Check if memory or OS resources are sufficient.	Check if the memory or OS resource is sufficient.
Failed to get size from the cfmgr library. Check if memory or OS resources are sufficient.	Check if the memory or OS resource is sufficient.
Failed to allocate memory.	Check if the memory or OS resource is sufficient.
Failed to change the directory.	
Failed to run the command.	
Failed to make a directory.	
Failed to remove the directory.	
Failed to remove the file.	
Failed to open the file.	
Failed to read the file.	
Failed to write the file.	
Internal error. Check if memory or OS resources are sufficient.	Check if the memory or OS resource is sufficient.
The upload is completed successfully. To start the cluster, refer to "How to create a cluster" in the Installation and Configuration Guide.	The upload is successfully completed. To start the cluster, refer to Chapter 5 "Creating the cluster configuration data" in the <i>Installation and Configuration Guide</i> .
The upload is completed successfully. To apply the changes you made, shutdown and reboot the cluster.	The upload is successfully completed. To apply the changes you made, shut down the cluster, and reboot it.
The upload was stopped. To upload the cluster configuration data, stop the cluster.	The upload was stopped. To upload the cluster configuration data, stop the cluster.
The upload was stopped. To upload the cluster configuration data, stop the Mirror Agent.	The upload was stopped. To upload the cluster configuration data, stop the Mirror Agent.
The upload was stopped. To upload the cluster configuration data, stop the resources to which you made changes.	The upload was stopped. To upload the cluster configuration data, stop the resources to which you made changes.
The upload was stopped. To upload the cluster configuration data, stop the groups to which you made changes.	The upload was stopped. To upload the cluster configuration data, suspend the cluster. To upload, stop the group to which you made changes.
The upload was stopped. To upload the cluster configuration data, suspend the cluster.	The upload was stopped. To upload the cluster configuration data, suspend the cluster.



Changing, backing up, and checking cluster configuration data (clpcfctrl command)

Message	Cause/Solution
<p>The upload is completed successfully.                      To apply the changes you made, restart the Alert Sync.                      To apply the changes you made, restart the WebManager.</p>	<p>The upload is completed successfully. To apply the changes you made, restart the Alert Sync. To apply the changes you made, restart the WebManager service.</p>
<p>The upload is completed successfully.</p>	<p>The upload is successfully completed.</p>
<p>The upload was stopped.                      Failed to deliver the configuration data.                      Check if the other server is active and run the command again.</p>	<p>The upload was stopped. Failed to deliver the configuration data. Check if the other server is active and run the command again.</p>
<p>The upload was stopped.                      There is one or more servers that cannot be connected to.                      To apply cluster configuration information forcibly, run the command again with "--force" option.</p>	<p>The upload was stopped. The server that cannot connect exists. To forcibly upload the cluster configuration information, run the command again with the <i>-force</i> option.</p>

## Adjusting time-out temporarily (`clptoratio` command)

`clptoratio`: the `clptoratio` command extends or displays the current time-out ratio.

### Command line

```
clptoratio -r ratio -t time
clptoratio -i
clptoratio -s
```

<b>Description</b>	This command displays or temporarily extends the various time-out values of the following on all servers in the cluster.	
	<ul style="list-style-type: none"> <li>+ Monitor resource</li> <li>+ Heartbeat resource (except kernel heartbeat resource)</li> <li>+ Mirror Agent</li> <li>+ Mirror driver</li> <li>+ Alert synchronous service</li> <li>+ WebManager service</li> </ul>	
<b>Option</b>	<code>-r <i>ratio</i></code>	<p>Specifies the time-out ratio.</p> <p>Use 1 or larger integer.</p> <p>The maximum time-out ratio is 10,000.</p> <p>If you specify "1," you can return the modified time-out ratio to the original as you can do so when you are using the <code>-i</code> option.</p>
	<code>-t <i>time</i></code>	<p>Specifies the extension period.</p> <p>You can specify minutes for m, hours for h, and days for d. The maximum period of time is 30 days.</p> <p>Example: 2m, 3h, 4d</p>
	<code>-i</code>	Sets back the modified time-out ratio.
	<code>-s</code>	Refers to the current time-out ratio.
<b>Return Value</b>	0	Success
	Other than 0	Failure
<b>Remarks</b>	<p>When the cluster is shutdown, the time-out ratio you have set will become ineffective. However, if any server in the cluster is not shutdown, the time-out ratio and the extension period that you have set will be maintained.</p> <p>With the <code>-s</code> option, you can only refer to the current time-out ratio. You cannot see other information such as remaining time of extended period.</p> <p>You can see the original time-out value by using the status display command.</p> <p>Heartbeat time-out</p> <pre># clpstat --cl --detail</pre> <p>Monitor resource time-out</p>	

```
# clpstat --mon monitor resource name --detail
```

**Notes**

Run this command as the root user.

Make sure that the cluster daemon is activated in all servers in the cluster.

When you set the time-out ratio, make sure to specify the extension period. However, if you set “1” for the time-out ratio, you cannot specify the extension period.

You cannot specify a combination such as “2m3h,” for the extension period.

**Example of a command entry**

**Example 1:** Doubling the time-out ratio for three days

```
# clptoratio -r 2 -t 3d
```

**Example 2:** Setting back the time-out ratio to original

```
# clptoratio -i
```

**Example 3:** Referring to the current time-out ratio

```
# clptoratio -s
```

```
present toratio : 2
```

The current time-out ratio is set to 2.

**Error Message**

<b>Message</b>	<b>Cause/Solution</b>
Log in as root.	Log on as the root user.
Invalid configuration file. Create valid cluster configuration data by using the Builder.	Create valid cluster configuration data by using the Builder.
Invalid option.	Specify a valid option.
Specify a number in a valid range.	Specify a number within a valid range.
Specify a correct number.	Specify a valid number.
Scale factor must be specified by integer value of 1 or more.	Specify 1 or larger integer for ratio.
Specify scale factor in a range less than the maximum scale factor.	Specify a ratio that is not larger than the maximum ratio.
Set the correct extension period.	Set a valid extension period.
Ex) 2m, 3h, 4d	Set the extension period which does not exceed the maximum ratio.
Set the extension period in a range less than the maximum extension period.	Check if the cluster daemon is activated.
Could not connect to the server. Check if the cluster daemon is active.	Check if the cluster daemon is activated.
Server is not active. Check if the cluster daemon is active.	Check if there is any server in the cluster with the cluster daemon stopped.
Connection was lost. Check if there is a server where the cluster daemon is stopped in the cluster.	Check if there is any server in the cluster with the cluster daemon stopped.
Invalid parameter.	The value specified as a parameter of the command may be invalid.
Internal communication timeout has occurred in the cluster server. If it occurs frequently, set the longer timeout.	Time-out has occurred in the internal communication of EXPRESSCLUSTER. If it occurs frequently, set the internal communication time-out longer.
Processing failed on some servers. Check the status of failed servers.	There are servers that failed in processing. Check the status of server in the cluster. Operate it while all the servers in the cluster are up and running.
Internal error. Check if memory or OS resources are sufficient.	Check to see if the memory or OS resource is sufficient.

## Modifying the log level and size (clplogcf command)

**clplogcf:** the `clplogcf` command modifies and displays log level and log output file size.

### Command line

```
clplogcf -t type -l level -s size
```

<b>Description</b>	This command modifies the log level and log output file size, or displays the values currently configured.	
<b>Option</b>	-t	Specifies a module type whose settings will be changed.  If both <code>-l</code> and <code>-s</code> are omitted, the information set to the specified module will be displayed. For the types which can be specified, see the list of “Types that can be specified for the <code>-t</code> option” on page 443.
	-l	Specifies a log level.  You can specify one of the following for a log level.  1, 2, 4, 8, 16, 32  You can see more detailed information as the log level increases.  For the default values for each module type, see the list of “Default log levels and log file sizes” on page 446.
	-s	Specifies the size of a file for log output.  The unit is byte.
	None	Displays the entire configuration information currently set.
<b>Return Value</b>	0	Success
	Other than 0	Failure
<b>Remarks</b>	Each type of output logs from EXPRESSCLUSTER uses four log files. Therefore, it is necessary to have the disk space that is four times larger than what is specified by <code>-s</code> .	
<b>Notes</b>	Run this command as the root user.  To run this command, the EXPRESSCLUSTER event service must be started.  The changes made are effective only for the server on which this command was run. The settings revert to the default values when the server restarts.	

**Example of  
command  
execution****Example 1:** Modifying the pm log level

```
# clplogcf -t pm -l 8
```

**Example 2:** Seeing the pm log level and log file size

```
# clplogcf -t pm
TYPE, LEVEL, SIZE
pm, 8, 1000000
```

**Example 3:** Displaying the values currently configured

```
# clplogcf
TYPE, LEVEL, SIZE
trnsv, 4, 1000000
xml, 4, 1000000
logcf, 4, 1000000
```

**Error Message**

Message	Cause/Solution
Log in as root.	Log on as the root user.
Invalid option.	The option is invalid. Check the option.
Failed to change the configuration. Check if clpevent is running.	clpevent may not have been started.
Invalid level	The specified level is invalid.
Invalid size	The specified size is invalid.
Failed to load the configuration file. Check if memory or OS resources are sufficient.	Non-clustered server
Failed to initialize the xml library. Check if memory or OS resources are sufficient.	Check to see if the memory or OS resource is sufficient.
Failed to print the configuration. Check if clpevent is running.	clpevent may not be started yet.

**Types that can be specified for the -t option (y=yes, n=no)**

Type	Module	Description	The EXPRESS CLUSTER Server	Replicator	Replicator DR
apicl	libclpapi.so.1.0	API client library	y	y	y
apisv	libclpapisv.so.1.0	API server	y	y	y
bmccnf	clpbmccnf	BMC information update command	y	y	y
cl	clpcl	Cluster startup and stop command	y	y	y
cfctrl	clpcfctrl	Cluster generation, cluster information and backup command	y	y	y
cfmgr	libclpcfmgr.so.1.0	Cluster configuration data operation library	y	y	y
cpufreq	clpcufreq	CPU Frequency control command	y	y	y
down	clpdown	Server stopping command	y	y	y
grp	clpgrp	Group startup, stop, move, and migration command	y	y	y
rsc	clprsc	Group resource startup and stop command	y	y	y
haltp	clpuserw	Shutdown monitoring	y	y	y
healthchk	clphealthchk	Process health check command	y	y	y
lcns	libclplcns.so.1.0	License library	y	y	y
lcnsc	clplcnsc	License registration command	y	y	y
ledctrl	clpledctrl	Chassis identify control command	y	y	y
logcc	clplogcc	Collect Logs command	y	y	y
logcf	clplogcf	Log level and size modification command	y	y	y
logcmd	clplogcmd	Alert producing command	y	y	y
mail	clpmail	Mail Report	y	y	y
mgmtmib	libclpmgmtmib.so.1.0	SNMP coordination library	y	y	y
mm	libclpmm.so.1.0	External monitoring coordination library	y	y	y
monctrl	clpmonctrl	Monitoring control command	y	y	y
nm	clpnm	Node map management	y	y	y
pm	clppm	Process management	y	y	y
rc/rc_ex	clprc	Group and group resource management	y	y	y
reg	libclpreg.so.1.0	Reboot count control library	y	y	y
regctrl	clpregctrl	Reboot count control command	y	y	y
rm	clprm	Monitor management	y	y	y
roset	clproset	Disk control	y	y	y
relpath	clprelpath	Process kill command	y	y	y
scrpc	clpscrpc	Script log rotation command	y	y	y
skgxn	libclpskgxn.so.1.0	Oracle Clusterware linkage library	y	y	y
stat	clpstat	Status display command	y	y	y

Type	Module	Description	The EXPRESSCLUSTER Server	Replicator	Replicator DR
stdn	clpstdn	Cluster shutdown command	y	y	y
toratio	clptoratio	Time-out ratio modification command	y	y	y
trap	clptrap	SNMP trap command	y	y	y
trncl	libclptrncl.so.1.0	Transaction library	y	y	y
trnreq	clptrnreq	Inter-cluster processing request command	y	y	y
rexec	clprexec	External monitoring link processing request command	y	y	y
bwctrl	clpbwctrl	Cluster activation synchronization wait processing control command	y	y	y
trnsv	clptrnsv	Transaction server	y	y	y
vxdgc	clpvxdgc	VxVM disk group import/deport command	y	y	y
alert	clpaltinsert	Alert	y	y	y
webmgr	clpwebmc	WebManager	y	y	y
webalert	clpaltd	Alert synchronization	y	y	y
rd	clprd	Process for smart failover	y	y	y
rdl	libclprdl.so.1.0	Library for smart failover	y	y	y
disk	clpdisk	Disk resource	y	y	y
disk_fsck	clpdisk	Disk resource	y	Y	Y
exec	clpexec	Exec resource	y	y	y
fip	clpfip	FIP resource	y	y	y
fipw	clpfipw	FIP monitor resource	y	y	y
nas	clpnas	NAS resource	y	y	y
volmgr	clpvolmgr	Volume manager resource	y	y	y
vip	clpvip	Virtual IP resource	y	y	y
vm	clpvm	VM resource	y	y	y
ddns	clpddns	Dynamic DNS resource	y	y	y
arpw	clparpw	ARP monitor resource	y	y	y
bmcw	clpbmcw	BMC monitor resource	y	y	y
diskw	clpdiskw	Disk monitor resource	y	y	y
ipw	clpipw	IP monitor resource	y	y	y
miiw	clpmiiw	NIC link up/down monitor resource	y	y	y
mtw	clpmtw	Multi target monitor resource	y	y	y
osmw	clposmw	Oracle Clusterware Synchronization Management monitor resource	y	y	y
pidw	clppidw	PID monitor resource	y	y	y
volmgrw	clpvolmgrw	Volume manager monitor resource	y	y	y
userw	clpuserw	User-mode monitor resource	y	y	y
vipw	clpvipw	Virtual IP monitor resource	y	y	y



Type	Module	Description	The EXPRESS CLUSTER Server	Replicator	Replicator DR
vmw	clpvmw	VM monitor resource	y	y	y
ddnsw	clpddnsw	Dynamic DNS monitor resource	y	y	y
mrw	clpmrw	Message receive monitor resource	y	y	y
genw	clpgenw	Custom monitor resource	y	y	y
bmchb	clpbmchb	BMC heartbeat	y	y	y
bmccmd	libclpbmc	BMC heartbeat library	y	y	y
snmpmgr	libclp snmpmgr	SNMP trap reception library	y	y	y
comhb	clpcomhb	COM heartbeat	y	y	y
diskhb	clpdiskhb	Disk heartbeat	y	y	y
lanhb	clplanhb	LAN heartbeat	y	y	y
lankhb	clplankhb	Kernel mode LAN heartbeat	y	y	y
pingnp	libclppingnp.so.1.0	PING network partition resolution	y	y	y
exping	libclppingnp.so.1.0	PING network partition resolution	y	y	y
mdadm	libclpmdadm.so.1.0	Mirror disk admin library	n	y	y
mdfunc	libclpmdfunc.so.1.0	Mirror disk function library	n	y	y
mdagent	clpmdagent	Mirror agent	n	y	y
mdctrl	clpmdctrl	Mirror disk resource operation command	n	y	n
mdinit	clpmdinit	Mirror disk initialization command	n	y	n
mdstat	clpmdstat	Mirror status display command	n	y	n
hdctrl	clphdctrl	Hybrid disk resource operation command	n	n	y
hdinit	clphdinit	Hybrid disk resource initialization command	n	n	y
hdstat	clphdstat	Hybrid status display command	n	n	y
md	clpmd	Mirror disk resource	n	y	n
md_fsck	clpmd	Mirror disk resource	n	y	n
mdw	clpmdw	Mirror disk monitor resource	n	y	n
mdnw	clpmdnw	Mirror disk connect monitor resource	n	y	n
hd	clphd	Hybrid disk resource	n	n	y
hd_fsck	clphd	Hybrid disk resource	n	n	y
hdw	clphdw	Hybrid disk monitor resource	n	n	y
hdnw	clphdnw	Hybrid disk connect monitor resource	n	n	y
oraclew	clp_oraclew	Oracle monitor resource	y	y	y
oracleasw	clp_oracleasw	OracleAS monitor resource	y	y	y
db2w	clp_db2w	DB2 monitor resource	y	y	y
psqlw	clp_psqlw	PostgreSQL monitor resource	y	y	y
mysqlw	clp_mysqlw	MySQL monitor resource	y	y	y
sybasew	clp_sybasew	Sybase monitor resource	y	y	y
sambaw	clp_sambaw	Samba monitor resource	y	y	y

Type	Module	Description	The EXPRESS CLUSTER Server	Replicator	Replicator DR
nfs	clp_nfs	NFS monitor resource	y	y	y
http	clp_http	HTTP monitor resource	y	y	y
ftp	clp_ftp	FTP monitor resource	y	y	y
smtp	clp_smtp	SMTP monitor resource	y	y	y
pop3	clp_pop3	POP3 monitor resource	y	y	y
imap4	clp_imap4	IMAP4 monitor resource	y	y	y
tux	clp_tux	Tuxedo monitor resource	y	y	y
wls	clp_wls	WebLogic monitor resource	y	y	y
was	clp_was	WebSphere monitor resource	y	y	y
otx	clp_otx	WebOTX monitor resource	y	y	y
jra	clp_jra	JVM monitor resource	y	y	y
sra	clp_sra	System monitor resource	y	y	y
ps	clp_ps	Process name monitor resource	y	y	y
mdperf	clp_mdperf	Disk related information	n	y	y
vmctrl	libclpvmctrl.so.1.0	VMCtrl library	y	y	y
vmwcmd	clpvmwcmd	VMW command	y	y	y
awsip	clpawsip	AWS elastic ip resource	y	y	y
awsvip	clpawsvip	AWS virtual ip resource	y	y	y
awsipw	clpawsipw	AWS elastic ip monitor resource	y	y	y
awsvipw	clpawsvipw	AWS virtual ip monitor resource	y	y	y
awsazw	clpawsazw	AWS AZ monitor resource	y	y	y
azurepp	clpazurepp	Azure probe port resource	y	y	y
azureppw	clpazureppw	Azure probe port monitor resource	y	y	y
azurelbw	clpazurelbw	Azure load balance monitor resource	y	y	y

**Default log levels and log file sizes**

Type	Level	Size (byte)
apicl	4	5000000
apisv	4	5000000
bmcnf	4	1000000
cfmgr	4	1000000
cl	4	1000000
cfctrl	4	1000000
cpufreq	4	1000000
down	4	1000000
grp	4	1000000
rsc	4	1000000

Type	Level	Size (byte)
haltp	4	1000000
healthck	4	1000000
lcns	4	1000000
lcnsc	4	1000000
ledctrl	4	1000000
logcc	4	1000000
logcf	4	1000000
logcmd	4	1000000
mail	4	1000000
mgmtmib	4	1000000
mm	4	2000000
monctrl	4	1000000
nm	4	2000000
pm	4	1000000
rc	4	5000000
rc_ex	4	5000000
rd	4	1000000
rdl	4	1000000
reg	4	1000000
regctrl	4	1000000
rm	4	5000000
roset	4	1000000
relpath	4	1000000
scrpc	4	1000000
skgxn	4	1000000
stat	4	1000000
stdn	4	1000000
toratio	4	1000000
trap	4	1000000
trncl	4	2000000
trnreq	4	1000000
rexec	4	1000000
trnsv	4	2000000
vxdgc	4	1000000
alert	4	4000000
webmgr	4	1000000
webalert	4	1000000
disk	4	2000000
disk_fsck	4	1000000

Type	Level	Size (byte)
exec	4	1000000
fip	4	1000000
fipw	4	1000000
nas	4	1000000
volmgr	4	1000000
vip	4	1000000
vm	4	1000000
ddns	4	1000000
bwctrl	4	1000000
arpw	4	1000000
bmcw	4	1000000
db2w	4	4000000
diskw	4	1000000
ftpw	4	1000000
httpw	4	1000000
imap4w	4	1000000
ipw	4	1000000
miiw	4	1000000
mtw	4	1000000
mysqlw	4	4000000
nfs	4	1000000
oraclew	4	4000000
oracleasw	4	1000000
osmw	4	1000000
otw	4	1000000
pidw	4	1000000
pop3w	4	1000000
psqlw	4	4000000
volmgrw	4	1000000
sambaw	4	1000000
smtpw	4	1000000
sybasew	4	4000000
tuxw	4	1000000
userw	4	1000000
vipw	4	1000000
vmw	4	1000000
ddnsw	4	1000000
mrw	4	1000000
genw	4	1000000

Type	Level	Size (byte)
wasw	4	1000000
wlsw	4	1000000
jraw	4	1000000
sraw	4	1000000
psw	4	1000000
bmchb	4	1000000
bmccmd	4	1000000
snmpmgr	4	1000000
comhb	4	1000000
diskhb	4	1000000
lanhb	4	1000000
lankhb	4	1000000
pingnp	4	1000000
exping	4	1000000
mdadm	4	10000000
mdfunc	4	10000000
mdagent	4	10000000
mdctrl	4	10000000
mdinit	4	10000000
mdstat	4	10000000
hdctrl	4	10000000
hdinit	4	10000000
hdstat	4	10000000
md	4	10000000
md_fsck	4	10000000
mdw	4	10000000
mdnw	4	10000000
hd	4	10000000
hd_fsck	4	10000000
hdw	4	10000000
hdnw	4	10000000
vmctrl	4	10000000
vmwcmd	4	1000000
liscal *1	-	0
clpka *1	-	0
clpkhb *1	-	0
awseip	4	10000000
awsvip	4	10000000
awseipw	4	10000000

Type	Level	Size (byte)
awsvipw	4	10000000
awsazw	4	10000000
azurepp	4	10000000
azureppw	4	10000000
azurelbw	4	10000000

\* If the module's size is zero, its log will not be produced.

\*1 Output destination of log is syslog.

## Managing licenses (clplcncsc command)

**clplcncsc:** the `clplcncsc` command manages licenses.

**Command line:**

```
clplcncsc -i [licensefile] -p productid
clplcncsc -l -p productid
clplcncsc -d -p productid
clplcncsc -d -p productid -t
clplcncsc -v
clplcncsc --ID
```

**Description** This command registers, refers to and remove the licenses of the product version and trial version of this product.

<b>Option</b>	<p><code>-i</code> <code>[licensefile]</code></p> <p><code>-l</code></p> <p><code>-d</code></p> <p><code>-t</code></p> <p><code>-v</code></p> <p><code>--ID</code></p> <p><code>-p productid</code></p>	<p>Registers the license with the specified product ID. When a license file is specified, license information is acquired from the file for registration. If nothing is specified, you need to enter license information interactively.</p> <p>References the license with the specified product ID.</p> <p>Deletes the license with the specified product ID.</p> <p>Deletes the license of the trial version with the specified product ID. Specify it together with the <code>-d</code> option.</p> <p>Displays a list of all registered licenses.</p> <p>Displays a list of product IDs that can be specified.</p> <p>Specifies the product ID of a licensed product.</p>
---------------	-------------------------------------------------------------------------------------------------------------------------------------------------------------------------------------------------------------	-------------------------------------------------------------------------------------------------------------------------------------------------------------------------------------------------------------------------------------------------------------------------------------------------------------------------------------------------------------------------------------------------------------------------------------------------------------------------------------------------------------------------------------------------------------------------------------------------------------------------------------------------------------------------------

Cluster product

<b>Product ID</b>	<b>License product name</b>
BASE33	EXPRESSCLUSTER X 3.3 for Linux
BASE33	EXPRESSCLUSTER X 3.3 for Linux VM
UPGR33	EXPRESSCLUSTER X for Linux Upgrade
XSS33	EXPRESSCLUSTER X SingleServerSafe 3.3 for Linux
XSS33	EXPRESSCLUSTER X SingleServerSafe 3.3 for Linux VM
REPL33	EXPRESSCLUSTER X 3.3 Replicator for Linux
RPDR33	EXPRESSCLUSTER X Replicator DR 3.3 for Linux
RPUP33	EXPRESSCLUSTER X Replicator DR 3.3 for Linux Upgrade

DBAG33	EXPRESSCLUSTER X Database Agent 3.3 for Linux
ISAG33	EXPRESSCLUSTER X Internet Server Agent 3.3 for Linux
FSAG33	EXPRESSCLUSTER X File Server Agent 3.3 for Linux
ASAG33	EXPRESSCLUSTER X Application Server Agent 3.3 for Linux
ALRT33	EXPRESSCLUSTER X Alert Service 3.3 for Linux
JRAG33	EXPRESSCLUSTER X Java Resource Agent 3.3 for Linux
SRAG33	EXPRESSCLUSTER X System Resource Agent 3.3 for Linux

<b>Return Value</b>	0	Normal termination
	1	Normal termination (with licenses not synchronized) * This means that license synchronization failed in the cluster at the time of license registration.  For the actions to be taken, refer to “Troubleshooting for licensing” in Appendix A “Troubleshooting” in the <i>Installation and Configuration Guide</i> .
	2	Initialization error
	4	Invalid option
	7	Other internal error

**Example of a command entry:**

**Registering the license interactively**

```
# clplcncs -i -p BASE33
```

**for registration**

**Product Version**

Select a product division.

```
Selection of License Version
1. Product Version
2. Trial Version
Select License Version. [1 or 2] .
```

Enter the number of licenses.

```
Enter number of license [0 (Virtual OS) or [ 1
to 99 (default:99) ] ...
```

Enter a serial number.

```
Enter serial number [ Ex. XXX0000000 ] .
```



Enter a license key.

```
Enter license key
[ Ex. XXXXXXXX-XXXXXXXX-XXXXXXXX-XXXXXXXX ] ...
```

### Trial Version

Select a product division.

```
Selection of License Version
1. Product Version
2. Trial Version
Select License Version. [1 or 2]
```

Enter a user name.

```
Enter user name [ 1 to 64byte ] .
```

Enter a trial start date.

```
Enter trial start date [ Ex. yyyy/mm/dd ] .
```

Enter a trial expiration date.

```
Enter trial end date [ Ex. yyyy/mm/dd ] .
```

Enter a license key.

```
Enter license key
[Ex. XXXXX-XXXXXXXX-XXXXXXXX-XXXXXXXX] .
```

Specify a license file

```
# clplcncs -i /tmp/cpulcns.key -p BASE33
```

for referring  
to the license

```
# clplcncs -l -p BASE33
```

1. Product version

```
< Cluster CPU License EXPRESSCLUSTER X 3.3
for Linux <PRODUCT> >
Seq... 1
Key.....
  A1234567-B1234567-C1234567-D1234567
The number of license... 2
Status... valid
```

2. Trial version

```
< Cluster CPU License EXPRESSCLUSTER X 3.3
```

```
for Linux <TRIAL> >
Seq... 1
Key.....
  A1234567-B1234567-C1234567-D1234567
User name... NEC
Start date..... 2014/01/01
End date..... 2014/12/31
Status..... valid
```

for referring  
to the license

```
# clplcncs -d-p BASE33
Command succeeded.
```

for referring  
to the license

```
# clplcncs -d-p BASE33 -t
Command succeeded.
```

for referring  
to the license

```
# clplcncs -v
< Cluster CPU License EXPRESSCLUSTER X 3.3 for Linux
<TRIAL> >
< Cluster CPU License EXPRESSCLUSTER X 3.3 for Linux
<PRODUCT> >
```

#### Notes

Run this command as the root user.

When you register a license, verify that the data transfer server is started up and a cluster has been generated for license synchronization.

When synchronizing the licenses, access the cluster servers in the order below, and use one of the paths that allowed successful access:

1. via the IP address on the interconnect LAN
2. via the IP address on the public LAN
3. via the IP address whose name was resolved by the server name in the cluster configuration data.

When you delete a license, only the license information on the server where this command was run is deleted. The license information on other servers is not deleted. To delete the license information in the entire cluster, run this command in all servers.

When the `-d` option is specified and if there are multiple license information regarding the product ID specified by the `-p` option, all the license information, including both trial license and product license, are deleted. To delete only the trial license, also specify the `-t` option. If the licenses including the product license have been deleted, register the product license again.

**Error Messages**

Message	Cause/Solution
Command succeeded.	The command ran successfully.
Command failed.	The command did not run successfully.
Command succeeded. But the license was not applied to all the servers in the cluster because there are one or more servers that are not started up.	There is one or more server that is not running in the cluster. Perform the cluster generation steps in all servers in the cluster. Refer to Chapter 3 "Installing EXPRESSCLUSTER" the <i>Installation and Configuration Guide</i> for information on cluster generation.
Log in as root.	You are not authorized to run this command. Log on as the root user.
Invalid cluster configuration data. Check it by using the Builder.	The cluster configuration data is invalid. Check the cluster configuration data by using the Builder.
Initialization error. Check if memory or OS resources are sufficient.	Check to see if the memory or OS resource is sufficient.
The command is already run.	The command is already running. Check the running status by using a command such as the ps command.
The license is not registered.	The license has not been registered yet.
Could not open the license file. Check if the license file exists on the specified path.	Input/Output cannot be done to the license file. Check to see if the license file exists in the specified path.
Could not read the license file. Check if the license file exists on the specified path.	
The field format of the license file is invalid. The license file may be corrupted. Check the destination from where the file is sent.	The field format of the license file is invalid. The license file may be corrupted. Check it with the file sender.
The cluster configuration data may be invalid or not registered.	The cluster configuration data may be invalid or not registered. Check the configuration data.
Failed to terminate the library. Check if memory or OS resources are sufficient.	Check to see if the memory or OS resource is sufficient.
Failed to register the license. Check if the optional product ID and entered license information is correct.	Check to see if the optional product ID or entered license information is correct.
Failed to open the license. Check if the optional product ID and entered license information is correct.	
Internal error. Check if memory or OS resources are sufficient.	Check to see if the memory or OS resource is sufficient.

## Locking disk I/O (clproset command)

**clproset:** the `clproset` command modifies and displays I/O permission of the partition device.

### Command line:

```
clproset -o [-d device_name | -r resource_name -t resource_type |
-a | --lockout]
clproset -w [-d device_name | -r resource_name -t resource_type |
-a | --lockout]
clproset -s [-d device_name | -r resource_name -t resource_type |
-a | --lockout]
```

<b>Description</b>	This command configures the partition device I/O permission of a shared disk to ReadOnly/ReadWrite possible.	
	This command displays the configured I/O permission status of the partition device.	
<b>Option</b>	<code>-o</code>	Sets the partition device I/O to ReadOnly. When ReadOnly is set to a partition device, you cannot write the data into the partition device.
	<code>-w</code>	Sets the partition device I/O to ReadWrite possible. When ReadWrite is set to a partition device, you may read from and write the data into the partition device.
	<code>-s</code>	Displays the I/O permission status of the partition device.
	<code>-d</code> <i>device_name</i>	Specifies a partition device.
	<code>-r</code> <i>resource_name</i>	Specifies a disk resource name.
	<code>-t</code> <i>resource_type</i>	Specifies a group resource type. For the current EXPRESSCLUSTER version, always specify “disk” as group resource type.
	<code>-a</code>	Runs this command against all disk resources.
	<code>--lockout</code>	Runs this command against the device specified as a disk lock device.
<b>Return Value</b>	0	Success
	Other than 0	Failure
<b>Notes</b>	Run this command as the root user.	
	This command can only be used on shared disk resources. It cannot be used for mirror disk resources and hybrid disk resources.	
	Make sure to specify a group resource type when specifying a resource name.	

**Example of command execution**

**Example 1:** When changing the I/O of disk resource name, disk1, to RW:

```
# clproset -w -r disk1 -t disk
/dev/sdb5 : success
```

**Example 2:** When acquiring I/O information of all resources:

```
# clproset -s -a
/dev/sdb5 : rw (disk)
/dev/sdb6 : ro (raw)
/dev/sdb7 : ro (lockout)
```

**Error Messages**

Message	Cause/Solution
Log in as root.	Log on as the root user.
Invalid configuration file. Create valid cluster configuration data by using the Builder.	Create valid cluster configuration data by using the Builder.
Invalid option.	Specify a valid option.
The -t option must be specified for the -r option.	Be sure to specify the -t option when using the -r option.
Specify 'disk' or 'raw' to specify a group resource.	Specify "disk" or "raw" when specifying a group resource type.
Invalid group resource name. Specify a valid group resource name in the cluster.	Specify a valid group resource name.
Invalid device name.	Specify a valid device name.
Command timeout.	The OS may be heavily loaded. Check to see how heavily it is loaded.
Internal error. Check if memory or OS resources are sufficient.	Check to see if the memory or OS resource is sufficient.

**Note:**

Do not use this command for the purposes other than those mentioned in “Verifying operation” in Chapter 8 in the *Installation and Configuration Guide*.

If you run this command while the cluster daemon is activated, the file system may get corrupted.

## Mirror-related commands

### Displaying the mirror status (`clpmdstat` command)

**clpmdstat:** the `clpmdstat` command displays status related to mirroring and configuration information.

**Command line:**

```
clpmdstat {--connect | -c} mirrordisk-alias
clpmdstat {--mirror | -m} mirrordisk-alias
clpmdstat {--active | -a} mirrordisk-alias
clpmdstat {--detail | -d} mirrordisk-alias
clpmdstat {--list | -l}
clpmdstat {--perf | -p} [interval [count]] mirrordisk-alias
```

<b>Description</b>	<p>This command displays the status related to mirroring.</p> <p>This command displays mirror disk resources configuration information.</p>	
<b>Option</b>	<p><code>--connect, -c</code></p> <p><code>--mirror, -m</code></p> <p><code>--active, -a</code></p> <p><code>--detail, -d</code></p> <p><code>--list, -l</code></p> <p><code>--perf</code></p>	<p>Displays mirror disk connect status.</p> <p>Displays mirror disk resource status.</p> <p>Displays status of mirror disk activation.</p> <p>Displays mirror disk resources configuration information.</p> <p>Displays mirror disk resources list.</p> <p>Displays statistical information on mirror disk resources.</p>
<b>Parameter</b>	<p><i>mirrordisk-alias</i></p> <p><i>interval</i></p> <p><i>count</i></p>	<p>Specifies a mirror disk resource name.</p> <p>Specifies the sampling interval for statistical information. If no value is specified, 60 (sec) is specified by default. You can specify a value from 1 to 9999.</p> <p>Specifies the number of times statistical information is displayed. This parameter is used together with the <i>interval</i>. You can specify a value from 1 to 9999. When <i>count</i> is omitted, statistical information is displayed indefinitely. To stop displaying statistical information, press [Ctrl] + [C].</p> <p>Both the default value of <i>interval</i>, 60, and of <i>count</i>, 1, are used if these parameters are omitted.</p>
<b>Return value</b>	<p>0</p> <p>Other than 0</p>	<p>Success</p> <p>Failure</p>
<b>Notes</b>	<p>Run this command as the root user.</p>	

**Example display after running this command**

An example of the display after running this command is provided in the next section.

**Error Messages**

Message	Cause/Solution
Error: Log in as root.	Log on as the root user.
Error: Failed to read the configuration file. Check if it exists or is configured properly.	Reading the configuration file has failed. Check to see if the configuration file exists and is configured correctly.
Error: Failed to acquire mirror disk resource name. Check if the Mirror Agent is operating normally.	Acquiring a mirror disk resource name has failed. Check to see if the Mirror Agent is operating normally.
Error: Specified mirror disk resource was not found. Specify a valid mirror disk resource name.	Failed to the specified mirror disk resource. Specify a valid mirror disk resource name.
Error: Invalid mirror-alias. Specify a valid mirror disk resource name.	Specify a valid mirror disk resource name.
Error: Failed to get the server name. Check if the configuration file is correct and the Mirror Agent is operating normally.	Acquiring a server name has failed. Check to see if the configuration file is valid and the Mirror Agent is operating normally.
Error: Failed to communicate with other servers. Check if the Mirror Agent of the other server is operating normally and the interconnect LAN is connected.	Communicating with the remote server has failed. Check if the Mirror Agent in the remote server is operating normally and the interconnect is connected.
Error: Mirror disks of the remote server may be down. Check if the Mirror Agent of the remote server is operating normally and the interconnect LAN is connected.	Communicating with the remote server has failed. Check to see if the Mirror Agent in the remote server is operating normally, and the interconnect is connected.
Error: Failed to get the mirror disk status. Check if the Mirror Agent on the local server is operating normally.	Acquiring the mirror disk status has failed. Check to see if the Mirror Agent in the local server is operating normally.
Error: Failed to acquire the mirror index. Check if the Mirror Agent is operating normally.	Check to see if the Mirror Agent is operating normally.
Error: mirror agent is not running Check if the Mirror Agent is active.	The Mirror Agent is not started up. Check the syslog or the alert message of the module type, mdagent.
Error: Failed to acquire the active status of the Mirror Agent of the local server. Shut down the cluster and reboot both servers	Acquiring the active status of mirror disk resource of the local server has failed. Shut down the cluster and restart both servers.
Error: Failed to acquire the active status of the Mirror Agent of the other server. Shut down the cluster and reboot both servers	Acquiring the active status of a mirror disk resource of the remote server has failed. Shut down the cluster and restart both servers.
Error: Failed to acquire mirror recovery status. Reboot the local server.	Acquiring the mirror recovery status has failed. Restart the local server.
Error: Failed to acquire the list of mirror disks. Reboot the local server.	Acquiring a list of mirror disks has failed. Restart the local server.
Error: Failed to acquire the mirror configuration information. Check if the Mirror Agent is operating normally.	Acquiring the mirror configuration data has failed. Check to see if the Mirror Agent is operating normally.

Message	Cause/Solution
Error: Failed to acquire the mirror configuration information error. Check if the Mirror Agent is operating normally.	Acquiring the mirror disk configuration data of both servers has failed. Check if the Mirror Agent is operating normally.
Error: Failed to get acquire mirror- disk configuration information. Reboot the local server.	Acquiring the mirror disk configuration data. Restart the local server.
Error: get local and remote Failed to acquire the mirror- disk configuration information error of both servers. Shut down the cluster and reboot both servers	Acquiring the mirror disk configuration data of both servers failed. Shut down and restart both servers.
Error: The number of the bits of the bitmap is invalid. The mirror difference information of the cluster partition is invalid. Shut down the cluster. If it fails again, replace the disk. For procedure to replace the disk, see the Reference Guide.	Acquiring the mirror difference information in the cluster partition has failed. Shut down the cluster. If this error happens again, replace the disk.
Error: Failed to get bitmap information. Failed to acquire the mirror difference information of the local server. Reboot the local server.	The mirror difference information in the cluster partition is invalid. Shut down the cluster. If this error happens again, replace the disk.
Error: Failed to read the mirror difference information of the local server. Reboot the local server.	Reading the mirror difference information of the local server has failed. Restart the local server.
Error: Failed to acquire semaphore. Reboot the local server.	Acquiring semaphore has failed. Restart the local server.
Error: A malloc error. Failed to reserve the memory space. Reboot the local server.	Reserving memory space has failed. Restart the local server.
Error: Mirror driver of the local server is not loaded. Refer to the Reference Guide to load the driver.	The mirror driver in the local server is not loaded. Check this by referring to Chapter 11 "Troubleshooting" in this guide.
Error: Internal error (errorcode: 0xxxx). Shut down the cluster and reboot the server.	Shut down the cluster and restart the server.
Error: Failed to communicate with server %1 and %2. Check if both Mirror Agents of the two servers are operating normally and the interconnect LANs are connected.	Failed to communicate with both servers represented in the message. Make sure that the mirror agents of both servers are running and the interconnect LANs are connected.  The server names are displayed where "%1" and "%2" are represented.
Error: Failed to communicate with server %1. Check if Mirror Agent of the server is operating normally and the interconnect LAN is connected. Failed to acquire the mirror disk detail information of the server %2. Shut down the cluster and reboot both servers.	Failed to communicate with the server %1. Check if the Mirror Agent of the other server is running and the interconnect LAN is connected.  Failed to acquire the mirror disk detail information of the server %2. Shut down the cluster, and then restart the both servers.  The server names are displayed where "%1" and "%2" are represented.



Message	Cause/Solution
<p>Error: Failed to acquire the mirror disk detail information of the server %1. Shut down the cluster and reboot both servers.</p> <p>Failed to communicate with server %2. Check if Mirror Agent of the server is operating normally and the interconnect LAN is connected.</p>	<p>Failed to acquire the mirror disk detail information of the server %1. Shut down the cluster, and then restart the both servers.</p> <p>Failed to communicate with the server %2. Check if the Mirror Agent of the other server is running and the interconnect LAN is connected.</p> <p>The server name is displayed where “%1” or “%2” is represented.</p>
<p>Error: Failed to acquire the mirror disk detail information of the server %1 and server %2. Shut down the cluster and reboot both servers."</p>	<p>Failed to acquire the mirror disk detail information of both servers. Shut down the cluster, and then restart the servers.</p> <p>The server name is displayed where “%1” or “%2” is represented.</p>
<p>Error: Failed to communicate with server %1. Check if Mirror Agent of the server is operating normally and the interconnect LAN is connected.</p> <p>Failed to acquire mirror disk %3 net interface status of the server %2. Shut down the cluster and reboot both servers.</p>	<p>Failed to communicate with the server %1. Check if the Mirror Agent of the other server is running and the interconnect LAN is connected.</p> <p>Failed to acquire the status of mirror disk connect of mirror disk resource %3 of server %2. Shut down the cluster and reboot both servers.</p> <p>The server name is displayed where “%1” or “%2” is represented.</p> <p>Where %3 is represented, the mirror resource name is displayed.</p>
<p>Error: Failed to acquire mirror disk %3 net interface status of the server %1. Shut down the cluster and reboot both servers.</p> <p>Failed to communicate with server %2. Check if Mirror Agent of the server is operating normally and the interconnect LAN is connected.</p>	<p>Failed to acquire the status of mirror disk connect of mirror disk resource %3 of server %1. Shut down the cluster and reboot both servers.</p> <p>Failed to communicate with the server %2. Check if the Mirror Agent of the other server is running and the interconnect LAN is connected.</p> <p>The server name is displayed where “%1” or “%2” is represented.</p> <p>Where %3 is represented, the mirror resource name is displayed.</p>
<p>Error: Failed to acquire mirror disk %3 net interface status of the server %1 and server %2. Shut down the cluster and reboot both servers.</p>	<p>Failed to acquire the status of mirror disk connect of both servers. Shut down the cluster, and then, restart the servers.</p> <p>The server name is displayed where “%1” or “%2” is represented.</p> <p>Where %3 is represented, the mirror resource name is displayed.</p>
<p>Error: Failed to communicate with server %1. Check if Mirror Agent of the server is operating normally and the interconnect LAN is connected.</p> <p>Failed to acquire the active status of the Mirror disk %3 of the server %2. Shut down the cluster and reboot both servers.</p>	<p>Failed to communicate with the server %1. Check if the Mirror Agent of the other server is running and the interconnect LAN is connected.</p> <p>Failed to acquire the active status of the Mirror disk resource %3 of the server %2. Shut down the cluster and reboot both servers.</p> <p>The server name is displayed where “%1” or “%2” is represented.</p> <p>Where %3 is represented, the mirror resource name is displayed.</p>

Message	Cause/Solution
Error: Failed to acquire the active status of the Mirror disk %3 of the server %1. Shut down the cluster and reboot both servers. Failed to communicate with server %2. Check if Mirror Agent of the server is operating normally and the interconnect LAN is connected.	Failed to acquire the active status of the mirror disk resource %3 of the server %1. Shut down the cluster and reboot both servers.  Failed to communicate with the server %2. Check if the Mirror Agent of the other server is running and the interconnect LAN is connected.  Where %1 or %2 is represented, the server name is displayed.  Where %3 is represented, the mirror resource name is displayed.
Error: Failed to acquire the active status of the Mirror disk %3 of the server %1 and server %2. Shut down the cluster and reboot both servers.	Failed to acquire the mirror disk detail information of both servers. Shut down the cluster, and then restart the servers.  Where %1 or %2 is represented, the server name is displayed.  Where %3 is represented, the mirror resource name is displayed.
Error: Failed to get all server names. Check if the configuration file is correct and the Mirror Agent is operating normally.	Failed to acquire the server name. Check if the configuration file is correct and the Mirror Agent is operating normally.
Error: The disk alias does not match the command.	The resource type of the specified resource name (mirror alias name) is invalid. Use <code>clpmdctrl</code> for md resource, and <code>clphdctrl</code> for hd resource.
Error: Invalid command name.	The command name is invalid. Do not change the file name of the <code>clphdctrl</code> command.
Error: The function of collecting statistics is disabled.	The statistical information collection function is disabled. Check the setting of <b>Gather Statistical information</b> on the <b>Mirror Agent</b> tab in <b>Cluster Properties</b> by using the Builder.
Error: Collecting mirror statistics failed. Please retry in a few seconds later.	It failed to collect statistical information because of a temporarily high-load or other issue. Wait, and then execute the command again. If this message displays again, make sure that <code>mdagent</code> is running normally.

## Display examples

◆ Mirror disk connect status display

When the `--connect` option is specified, the status of mirror disk connect is displayed.

```
Mirror Name : md1

[Server : server1]
 192.168.0.1           : Using

[Server : server2]
 192.168.0.2           : Using
```

Explanation of each item

Item	Description										
Server Name	Name of the server										
IP Address	IP address specified by mirror disk connect										
Status	Status of mirror disk connect										
	<table border="1"> <thead> <tr> <th>Status</th> <th>Description</th> </tr> </thead> <tbody> <tr> <td>Using</td> <td>Being used</td> </tr> <tr> <td>Free</td> <td>Not used</td> </tr> <tr> <td>Error</td> <td>Error</td> </tr> <tr> <td>--</td> <td>Unknown</td> </tr> </tbody> </table>	Status	Description	Using	Being used	Free	Not used	Error	Error	--	Unknown
	Status	Description									
	Using	Being used									
	Free	Not used									
Error	Error										
--	Unknown										

◆ Displaying the status of mirror disk resource

The status of specified mirror disk resource is displayed by specifying the `--mirror` option. There are three types of display depending on the status of mirror disk resource:

(1) When the status of mirror disk resource is Normal:

```
Mirror Status: Normal

md1           server1           server2
-----
Mirror Color  GREEN             GREEN

Mirror disk resource      Local server      Remote server
```

Explanation of each item

Item	Description										
Mirror Status	Status of mirror disk resource										
	<table border="1"> <thead> <tr> <th>Status</th> <th>Description</th> </tr> </thead> <tbody> <tr> <td>Normal</td> <td>Normal</td> </tr> <tr> <td>Recovering</td> <td>Mirror is recovering</td> </tr> <tr> <td>Abnormal</td> <td>Abnormal</td> </tr> <tr> <td>No Construction</td> <td>Initial mirror construction is not done</td> </tr> </tbody> </table>	Status	Description	Normal	Normal	Recovering	Mirror is recovering	Abnormal	Abnormal	No Construction	Initial mirror construction is not done
	Status	Description									
	Normal	Normal									
	Recovering	Mirror is recovering									
Abnormal	Abnormal										
No Construction	Initial mirror construction is not done										

Item	Description	
Mirror Color	Status of mirror disk on each server	
	Status	Description
	GREEN	Normal
	YELLOW	Mirror is recovering
	RED	Abnormal
	GRAY	Being stopped, Unknown status
	BLACK	Initial mirror construction is not done, error found in cluster partition data, etc.
BLUE	Both disks are active	

(2) When the status of mirror disk resource is abnormal:

```

Mirror Status: Abnormal

mdl                server1                server2
-----
Mirror Color       GREEN                RED
Lastupdate Time   2004/02/24 15:41:07 --
Break Time        2004/02/24 15:40:38 --
Disk Error         OK                   OK
Difference Percent 1%                   0%
    
```

Explanation of each item

Item	Description	
Mirror Status	Status of mirror disk resource *1	
Mirror Color	Status of mirror disk on each server *1	
Last update Time	Last time when the data was updated on the server.	
Break Time	Time when mirror break has occurred	
Disk Error	Status of disk I/O	
	Status	Description
	OK	Normal
	ERROR	Error (No I/O)
	--	Unknown
Difference Percent	Percentage of differences in the data on each server.	

\*1 See "When the status of mirror disk resource is Normal:" on page 463.

(3) During mirror recovery:

```

Mirror Status: Recovering

mdl                server1                server2
-----
Mirror Color       YELLOW                YELLOW

Recovery Status   Value
-----
Status:           Recovering
Direction:  src   server1
              dst   server2
Percent:          3%
Used Time:        00:00:01
Remain Time:      00:00:32
Iteration Times:  1/1
    
```

Explanation of each item

Item	Description										
Mirror Status	Status of mirror disk resource *1										
Mirror Color	Status of mirror disk on each server *1										
Status	Status of mirror recovery										
	<table border="1"> <thead> <tr> <th>Status</th> <th>Description</th> </tr> </thead> <tbody> <tr> <td>Preparing</td> <td>Preparing for copy (This status may last for a while if I/O load is high when resource is getting started during recovery)</td> </tr> <tr> <td>Recovering</td> <td>Being recovered</td> </tr> <tr> <td>Completing</td> <td>Recovering is being completed</td> </tr> <tr> <td>Nothing</td> <td>Canceling recovery</td> </tr> </tbody> </table>	Status	Description	Preparing	Preparing for copy (This status may last for a while if I/O load is high when resource is getting started during recovery)	Recovering	Being recovered	Completing	Recovering is being completed	Nothing	Canceling recovery
	Status	Description									
	Preparing	Preparing for copy (This status may last for a while if I/O load is high when resource is getting started during recovery)									
	Recovering	Being recovered									
Completing	Recovering is being completed										
Nothing	Canceling recovery										
Direction	<table border="1"> <tbody> <tr> <td>src</td> <td>source server</td> </tr> <tr> <td>dst</td> <td>destination server</td> </tr> </tbody> </table>	src	source server	dst	destination server						
src	source server										
dst	destination server										
Percent	Percentage of how much data is already recovered										
Used Time	Elapsed time since recovering has started										
Remain Time	Estimated time to complete recovering the remaining data. It is estimated by the speed of already recovered data. The time may be different depending on server load.										
Iteration Times	The current repeat counts and the setting value of the mirror recovery.										

(1)\*1 See "When the status of mirror disk resource is Normal:" on page 463.

◆ Displaying active status of mirror disk resource

Active status of the specified mirror disk resource is displayed when the `--active` option is specified:

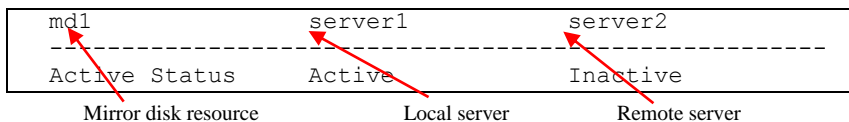

Status of mirror partition device

Active Status	Description
Active	Active
Inactive	Not active
--	Unknown

◆ Displaying mirror disk resource information

Configuration information of the specified mirror disk resource is displayed when the `--detail` option is specified:

```

Mirror Name : mdl
  Sync Switch      : On
  Sync Mode       : Sync
  Diff Recovery   : --
  Compress        :
    Sync Data     : Off
    Recovery Data : On

[Server : server1]
  NMP/Disk Size(MB) : 2447/2447
  DP Device        : /dev/sdb2
  CP Device        : /dev/sdb1

[Server : server2]
  NMP/Disk Size(MB) : 2447/2447
  DP Device        : /dev/sdb2
  CP Device        : /dev/sdb1
    
```

Explanation of each item

Item	Description	
Mirror Name	Mirror disk resource name	
Sync Switch	Perform data synchronization / Do not perform data synchronization	
Sync Mode	Synchronization Mode / Asynchronization Mode	
Compress	SyncData	Compress mirror synchronization data / Do not compress mirror synchronization data
	RecoveryData	Compress mirror recovery data / Do not compress mirror recovery data
Server Name	Server name	

Item	Description	
NMP/Disk Size(MB)	NMP	the smaller size of data partition of servers
	Disk Size	actual data partition size
DP Device	Data partition device name	
CP Device	Cluster partition device name	

◆ Displaying the list of mirror disk resources

The list of mirror disk resources is displayed when the `--list` option is specified:

```
[Replicator Option]
server1 : Installed
server2 : Installed
server3 : Installed

[Servers Which Can Be Started]
<md1>
  server1
  server3

<md2>
  server2
  server3
```

Explanation of each item

Item	Description
Replicator Option	License status of the Replicator
Servers Which Can Be Started	Servers which can be started of mirror disk resources

◆ Displaying statistical information

Performance figures for the mirroring function are displayed when the `--perf` option is specified:

md1									
---Write (MB)----		---Read (MB)----		---Send (MB)----		--SyncTime (s) --		-SyncDiff (MB)	
Total	Avg	Total	Avg	Total	Avg	Max	Cur	Max	Cur
0.14	0.00	0.10	0.00	0.02	0.00	0.04	0.02	0.07	None

Explanation of each item

Item	Description
Write (Total)	Total amount of data written in mirror partitions. The unit is MB. The output value indicates the amount of data written during each sampling interval.
Write (Avg)	Amount per unit time of data written in mirror partitions. The unit is MB/s.
Read (Total)	Total amount of data read from mirror partitions. The unit is MB. The output value indicates the amount of data read during each sampling interval.
Read (Avg)	Amount per unit time of data read from mirror partitions. The unit is MB/s.
Send (Total)	Total amount of mirror communication data sent using mirror disk connects. The unit is MB. The output value indicates the amount of communication data sent during each sampling interval. TCP control information and others are not included.
Send (Avg)	Amount per unit time of mirror communication data sent using mirror disk connects. The unit is MB/s.
SyncTime (Max)	Time required for synchronizing one mirror synchronization data item. The output value indicates the longest time required for synchronizing a mirror synchronization data item. The unit is seconds/synchronization. The time required for synchronizing mirror synchronization data which cannot be synchronized due to disabled communication or another cause (which causes a mirror brake) is not output. The output value indicates the time required for communication during each sampling interval.



Item	Description
SyncTime (Avg)	<p>Time required for synchronizing one mirror synchronization data item. The output value indicates the average time per communication. The unit is seconds/communication.</p> <p>The time required for synchronizing mirror synchronization data which cannot be synchronized due to disabled communication or another cause (which causes a mirror break) is not included.</p> <p>The output value indicates the average time required for communication during each sampling interval.</p>
SyncDiff (Max)	<p>Amount of mirror synchronization data which has not been synchronized with that on a remote server. The output value indicates the maximum value during each sampling interval. The unit is MB.</p> <p>The amount of mirror synchronization data which cannot be synchronized due to disabled communication or another cause (which causes a mirror break) is not included.</p>
SyncDiff (Cur)	<p>Amount of mirror synchronization data which has not been synchronized with that on a remote server. The output value indicates the latest amount at collection. The unit is MB.</p> <p>The amount of mirror synchronization data which cannot be synchronized due to disabled communication or another cause (which causes a mirror break) is not included.</p>

- ◆ The `clpmdstat` command displays statistical information to two decimal places. Actually collected data is converted to an appropriate unit and truncated to two decimal places when displayed. The following rules are used for conversion:  
 $1 \text{ KB} = 1024 \text{ bytes}$ ,  $1 \text{ MB} = 1048576 \text{ bytes}$
- ◆ When the result of truncating data is 0, "0.00" is displayed. When not that result, but the actual data is 0, "None" is displayed.
- ◆ The output value becomes information in the server that executed the command. Valid values are output only in the active server for Write (Total), Write (Avg), Read (Total), Read (Avg), SyncTime (Max), SyncTime (Avg), SyncDiff (Max), and SyncDiff (Cur). The status of these values is either hold or "none" in a standby server. Valid values are output in both active and standby servers for Send (Total) and Send (Avg).

## Operating mirror disk resource (`clpmdctrl` command)

`clpmdctrl`: the `clpmdctrl` command operates mirror disk resources.

### Command line:

```
clpmdctrl {--active | -a} mirrordisk-alias
clpmdctrl {--active | -a} -nomount mirrordisk-alias
clpmdctrl {--active | -a} -force [-ro] mirrordisk-alias
clpmdctrl {--active | -a} -force -nomount mirrordisk-alias
clpmdctrl {--deactive | -d} mirrordisk-alias
clpmdctrl {--break | -b} mirrordisk-alias
clpmdctrl {--recovery | -r} mirrordisk-alias
clpmdctrl {--force | -f} [-v] recovery-source-servername
mirrordisk-alias
clpmdctrl {--force | -f} mirrordisk-alias
clpmdctrl {--cancel | -c} mirrordisk-alias
clpmdctrl {--rwait | -w} [-timeout time [-rcancel]] mirrordisk-alias
clpmdctrl --getreq
clpmdctrl --setreq request-count
clpmdctrl --sync [mirrordisk-alias]
clpmdctrl --nosync [mirrordisk-alias]
clpmdctrl {--compress | -p} [mirrordisk-alias]
clpmdctrl {--nocompress | -n} [mirrordisk-alias]
clpmdctrl {--mdcswitch | -s} [mdc-priority] mirrordisk-alias
```

### Note:

Do not use the `--active`, and `--deactive` options when the cluster daemon is started. If you use them, the data in file system can be corrupted. Do not use these options for the purposes other than those mentioned in Chapter 9, "Preparing to operate a cluster system" in the *Installation and Configuration Guide*.

<b>Description</b>	<p>This command activates, deactivates or forcibly activates mirror disk resource and recovers or forcibly recovers mirror.</p> <p>This command disconnects a mirror disk.</p> <p>This command performs mirror recovery, forced mirror recovery, cancellation of mirror recovery, and waiting for the completion of mirror recovery.</p> <p>This command displays and/or modifies the settings of maximum number of request queues.</p> <p>This command switches the synchronization status of the mirror data.</p> <p>This command is used to set whether mirror data is to be compressed.</p> <p>This command switches the communication path (mirror disk connect) to be used.</p>
<b>Option</b>	<p><code>--active, -a</code> Activates the mirror disk resource on the local server.</p> <p>If the status of mirror disk resource is normal, mirroring is performed.</p> <p>If the status of mirror disk resource is not normal, mirroring will not be performed.</p>

-force	Forcibly activates a mirror disk resource. This command can be run on a server where mirroring is stopped. This option is used with the --active option.
-nomount	It allows access to mirror partition device without mounting the file system. This option is used with the --active option.
-ro	Forcibly activates a mirror disk resource in ReadOnly mode. This option is used with the --active -force options.
--deactive, -d	Deactivates the activated mirror disk resource on the local server.
--break, -b	Disconnects the mirror disk resources forcibly specified with <i>mirrordisk-alias</i> on the server where the command is run. The status of mirror disk resource on the server where the command is run becomes an error. The status on the server where the command is not run does not change.  When a mirror is recovered, disconnection is canceled.  Mirror data is not synchronized even when any data is written to a mirror disk.  Auto mirror recovery is not automatically started until reboot is performed or disconnection is canceled after completion of mirror recovery.
--recovery, -r	Performs either full mirror recovery or differential mirror recovery for the specified mirror disk resource.  Whether to perform full or differential mirror recovery is determined automatically.
--force, -f	Forcefully performs mirror recovery for the specified mirror disk resource.  If only <i>mirrordisk-alias</i> is specified, the status of mirror disk where the command is run becomes normal forcibly. Mirror resynchronization is not performed.  If <i>recovery-source-servername</i> and <i>mirrordisk-alias</i> are specified, full mirror recovery is performed using <i>recovery-source-servername</i> as source data.  The status of mirror disk becomes normal when a full mirror recovery completes.
-v	Forcefully performs mirror recovery without an analysis of the file system.
--cancel, -c	Cancels mirror recovery.

	<p>When <b>Auto Mirror Recovery</b> is selected and a mirror disk monitor resource is operating, mirror recovery is automatically resumed a while after it is canceled. In this case, suspend the mirror disk monitor resource by using the WebManager or <code>clpmonctrl</code> command, then run the command for canceling mirror recovery.</p>
<code>--rwait, -w</code>	<p>Waits for the completion of the mirror recovery of the specified mirror disk resource.</p>
<code>-timeout</code>	<p>Specifies the timeout period of mirror recovery completion (second). This option can be omitted. When this option is omitted, timeout is not executed and waits for the completion of mirror recovery.</p>
<code>-rcancel</code>	<p>Cancels mirror recovery when the timeout of waiting of mirror recovery completion occurred. This option can be set when <code>-timeout</code> option is set. When this option is omitted, the mirror recovery continues even after the timeout occurrence.</p>
<code>--getreq</code>	<p>Displays the current maximum number of request queues.</p>
<code>--setreq</code>	<p>Configures the maximum number of request queues.</p> <p>When the server shuts down, what you have configured here returns to the value set in the cluster configuration data. Use the Builder if you want to modify the cluster configuration data. For details, see “Cluster properties Mirror driver tab” in Chapter 2 “Functions of the Builder” in this guide.</p> <p>The command is only effective on the server that runs the command.</p>
<code>--sync</code>	<p>This option switches the operation to the mirror synchronization.</p> <p>When the mirror disk resource name is not specified, the operation is switched to synchronizing the mirror data to all mirror resources.</p>

<code>--nosync</code>	<p>This option switched the operation to the one that does not synchronize the mirror data.</p> <p>When the mirror disk resource name is not specified, the operation is switched to not performing the synchronization of the mirror data to all mirror resources.</p> <p>However, the data updated to a disk during a mirror recovery is synchronized to a standby server.</p> <p>If auto mirror recovery is set to ON and the mirror disk monitor resource is operating, automatic mirror recovery will operate.</p> <p>Even after the completion of mirror recovery, the operation will still not synchronize. To cancel this, execute the command with the <code>--sync</code> option specified.</p> <p>When the server is shut down, the state will return to the synchronization operation that is set in the cluster configuration information. To change the cluster configuration information, use the Builder. For details, see “Mirror tab” in “Mirror disk resource tuning properties” in “Displaying and changing the details of mirror disk resource” in “Understanding mirror disk resources” in Chapter 4, “Group resource details” in this guide.</p>
<code>--compress, -p</code>	<p>Temporarily switches on the compression mode of mirror transfer data.</p> <p>If the synchronous mode of mirror data is “Synchronous”, only the recovery transfer data is compressed.</p> <p>If the synchronous mode of mirror data is “Asynchronous”, both the asynchronous transfer data and the recovery transfer data are compressed.</p> <p>When the mirror disk resource name is not specified, the operation is performed to all mirror disk resources.</p>
<code>--nocompress, -n</code>	<p>Temporarily switches off the compression mode of mirror transfer data.</p> <p>When the mirror disk resource name is not specified, the operation is performed to all mirror disk resources.</p>
<code>--mdcswitch, -s</code>	<p>Switches the mirror connection to another mdc that has the specified priority.</p> <p>If the priority is not specified, the mirror connection is switched to the mdc that has the next highest priority after the current mdc. If the mirror connection is connected to the mdc that has the lowest priority, it is switched to the one that has the highest priority.</p> <p>If the mirror connection has already been switched to the specified mdc, the command terminates normally without performing any processing.</p> <p>If the specified mdc does not exist, an error occurs.</p>

<b>Parameter</b>	<i>recovery-source-server name</i>	Specifies a server name of the copy source.
	<i>mirrordisk-alias</i>	Specifies a mirror disk resource name.
	<i>request-count</i>	Specifies a maximum number of request queues. You can specify a number from 256 through 65535.
	<i>time</i>	Specifies the timeout period of mirror recovery completion (second).
	<i>mdc-priority</i>	Specifies the priority of mdc. This is not the priority number of mdc in whole cluster, but the priority number (1 or 2) of mdc used by the mirror disk resource.
<b>Return Value</b>	0	Success
	255 (-1)	Failure
	254 (-2)	Target mirror disk is not configuring mirror, or the mirror configuring failed on the process. (Only when <code>--rwait</code> option is specified, including the case when mirror recovery is interrupted by <code>-rcancel</code> .)
	253 (-3)	Timeout of mirror recovery of target mirror disk occurs (Only when <code>--rwait -timeout</code> option is specified)
<b>Remarks</b>	<p><i>request-count</i>, which is displayed by specifying the <code>--getreq</code> option, is the same as “Max. Number of Request Queues” which is displayed by using the <code>clpstat</code> command.</p> <p><b># clpstat --cl -detail</b></p> <p>This command returns control when the specified processing starts. Run the <code>clpmdstat</code> command to check the processing status.</p>	
<b>Notes</b>	<p>Run this command as the root user.</p> <p>When performing mirror recovery again after mirror recovery failed, specify the same server you used last time for mirror recovery as a copy source.</p> <p>To resume the forced mirror recovery that was suspended by selecting <b>Cancel</b>, use this command for forced mirror recovery.</p> <p>In a cluster with more than three nodes, if the server where the command is run is not included in a startup server of a group including mirror disk resources, this command results in error. Do not run this command if the server is not included in a startup server of a group.</p> <p>If, during mirror synchronization, mirror synchronization is interrupted with either the <code>--break (-b)</code> or <code>--nosync</code> option or if, during mirror recovery, mirror recovery is interrupted, the file system and application data may prove to be abnormal even if the mirror disk to be synchronized is made accessible by performing forced activation or forced mirror recovery. For details, see “Mirror data reference at the synchronization destination if mirror synchronization is interrupted” in Chapter 5, “Notes and Restrictions” in the <i>Getting Started Guide</i>.</p>	

**Example of  
command  
execution**

**Example 1:** When activating the mirror disk resource md1:

```
# clpmdctrl --active md1
<md1@server1>: active successfully
```

**Example 2:** When deactivating the mirror disk resource md1:

```
# clpmdctrl --deactive md1
<md1@server1>: deactive successfully
```

**Example 3:** When disconnecting the mirror disk resource md1:

```
# clpmdctrl --break md1
md1: isolate successfully
```

**Example 4:** When the status of both servers is error, and you need to recover the operation which uses the resource md1 as soon as possible:

```
# clpmdctrl --force md1
The data of mirror disk in local server maybe is
not latest.
Do you still want to continue? (Y/N)
md1: Force recovery successful.

# clpgrp -s failover1
Command succeeded.
```

When **Auto Mirror Recovery** is selected, mirror recovery is performed at this timing. When **Auto Mirror Recovery** is cleared, run the following command.

```
# clpmdctrl --recovery md1
```

**Example 5:** When mirror recovering the mirror disk resource md1:

```
# clpmdctrl --recovery md1
```

**Example 6:** When setting the maximum number of request queues to 2048:

```
# clpmdctrl --setreq 2048
current I/O request count <2048>
```

**Example 7:** When configure the setting that does not perform the data synchronization to the mirror disk resource md1:

```
# clpmdctrl --nosync md1
```

**Error Messages**

<b>Message</b>	<b>Cause/Solution</b>
Error: Log in as root.	Log on as the root user.
Error: Failed to read the configuration file. Check if it exists or is configured properly.	Reading the configuration file has failed. Check to see if the configuration file exists and is configured correctly.
Error: Specified mirror disk resource was not found. Specify a valid mirror disk resource name.	Locating the specified mirror disk resource has failed. Specify a valid mirror disk resource name.
Error: Invalid mirror-alias. Specify a valid mirror disk resource name.	Specify a valid mirror disk resource name.
Error: Failed to get the server name. Check if the configuration file is correct and the Mirror Agent is operating normally.	Acquiring the server name has failed. Check if configuration file is correct and the Mirror Agent is operating normally.
Error: Specified server name was not found. Check if the server name exists in the configuration file.	The specified server name was not found. Check to see if the entered server name exists in the configuration file.
Error: Invalid server name. Specify a valid server name.	Specify a valid sever name.
Error: Failed to communicate with other servers. Check if the Mirror Agent of the other server is operating normally and the mirror disk connect is connected.	Communicating with the remote server has failed. Check to see if the Mirror Agent of the remote server is operating and the mirror disk is connected.
Error: Failed to get the mirror disk status. Check if the Mirror Agent on the local server is operating normally.	Acquiring the mirror disk status has failed. Check to see if the Mirror Agent of the local server is operating normally.
Error: Failed to get the mirror index. Check if the Mirror Agent is operating normally.	Check to see if the Mirror Agent is operating normally.
Error: The status of mirror disk resource of the local server is abnormal.	The mirror disk resource of the local server has a problem.
Error: Specified mirror disk resource is already active. Check active status of mirror disk resource by running the following command: <code>clpmdstat --active &lt;alias&gt;</code>	The specified mirror disk resource is already activated. Check the status of the mirror disk resource using the following command.  <code>clpmdstat --active &lt;alias&gt;</code>
Error: A hardware error has occurred on the disk. Check the disk.	A hardware error has occurred on the disk. Check the disk.
Error: The sizes of data partition of the servers do not match.	Data partition sizes of both servers do not match.
Error: Specified mirror disk is not active. Check the active status of mirror disk resource.	The specified mirror disk resource is not activated. Check the status of mirror disk resource.
Error: There is no recovering mirror disk resource.	There is no mirror disk under mirror recovery process.
Error: Mirror disk resource is recovering. Wait until mirror recovery completes.	The mirror disk resource is under mirror recovery process. Wait until mirror recovery is completed
Error: Failed to cancel the mirror recovery. The system may be highly loaded. Wait for a while and try again.	Stopping mirror recovery has failed. The system may be heavily loaded. Wait for a while and try again.



Message	Cause/Solution
Error: Performed mirror recovery to the mirror disk resource that is not necessary to recover the mirror. Run the <code>clpmdctrl --force</code> command if you want to perform forced mirror recovery.	Mirror recovery has been performed on the mirror disk resource that is in normal status and not requiring mirror recovery. To perform forced mirror recovery, use " <code>clpmdctrl --force</code> ."
Error: Specification of the server that is copied from is incorrect. When executing mirror recovery again after a failure end of mirror recovery, specify the same server as the previous one.	The server specified for a copy source is invalid. When performing the mirror recovery again after the mirror recovery has failed, specify the same server that you specified last time for the failed mirror recovery as a copy source.
Error: Forced mirror recovery is required. Run the <code>clpmdctrl --force</code> command to perform the recovery.	Forced mirror recovery is necessary. Use " <code>clpmdctrl --force</code> " and perform forced mirror recovery.
Error: Server with old data is specified as the server which is copied from. Specify a correct recovery direction.	The server with old data is specified as a copy source. Specify a correct recovery direction.
Error: Failed to acquire mirror recovery status. Reboot the local server.	Acquiring the mirror recovery status has failed. Restart the local server.
Error: Both of the mirrors are not constructed. Initial mirror configuration of the mirror disks by running the <code>clpmdctrl --force</code> command is necessary.	Initial mirror construction of mirror disk is necessary. Construct initial mirror configuration using " <code>clpmdctrl --force</code> ."
Error: Initial mirror configuration of mirror disk of local server is necessary. Specify the other server as the one that is copied from by using the <code>clpmdctrl --force</code> command to configure an initial mirror.	Initial mirror construction is necessary for the mirror disk of the local server. Specify the remote server as a copy source and construct initial mirror using " <code>clpmdctrl --force</code> ."
Error: Initial mirror configuration of mirror disk of the other server is necessary. Specify the local server as the one that is copied from by using the <code>clpmdctrl --force</code> command to configure an initial mirror.	Initial mirror construction is necessary for the mirror disk of the remote server. Specify the local server as a copy source and construct initial mirror using " <code>clpmdctrl --force</code> ."
Error: Mirror flag error. Use " <code>clpmdinit</code> " to construct the mirror. The status of cluster partition of the mirror disk resource is abnormal. When the server with the error has the latest data, backup the data, initialize the cluster partition, and replace the same disk by using the same disk. If the error persists, change the disk to new one.	The cluster partition of the mirror disk resource has a problem. When the server with error has the latest data, back up the data, initialize the cluster partition, and follow the same "disk replacement" steps using the same disk by seeing "Backup Procedure" and "Restoration Procedure" in Chapter 8 "Verifying Operation" in the <i>Installation and Configuration Guide</i> . If this occurs again, replace the disk with a new disk.
Error: Both local and remote mirrors are active. Shut down the cluster and execute forced mirror recovery after rebooting the server.	Both systems are active. Shut down the cluster and perform forced mirror recovery after reactivating the server.
Error: Mirror Agent is not running. Check if the Mirror Agent is active.	The Mirror Agent is not started up. Check to see if the Mirror Agent is running.
Error: System calls error. Failed to run the system command when active and/or inactive. Check if the search path is set to an environment variables.	Running the system command when active/inactive has failed. Check to see if a search path is set as an environmental variable.
Error: Failed to create a mount point. The disk space may not be sufficient.	Creating a mount point has failed. Disk space may be insufficient. Check it.

Message	Cause/Solution
Error: Timeout has occurred on active fsck. When it is not journaling file system, it may take time to run fsck if the size of data partition of mirror disk is large. Set timeout of fsck longer by using the Builder.	fsck time-out has occurred. In case it is not the journaling file system, running fsck may take time when the data partition of the mirror disk is large. Set the longer timer for the fsck time-out using the Builder.
Error: Timeout occurs at activation mount. Set mount timeout longer	Time-out has occurred at active mounting. Set the mounting time-out longer by using the Builder.
Error: Timeout occurs at deactivation mount. Set unmount timeout longer.	Time-out has occurred at inactive unmounting of the file system. Set the mount time-out period longer by using the Builder.
Error: fsck failed. Check if file system type of data partition does not match configuration file, fsck option is incorrect or partition is incorrect.	Running fsck has failed. Check to see if the file system type of the data partition matches to the configuration file, fsck option is valid, and partition is not destroyed.
Error: Failed to mount when active. The file system type of the data partition does not match the settings of the configuration file, or the partition may be corrupted.	Mounting during activation has failed. Check to see if the file system type of the data partition matches to the configuration file, fsck option is valid, and the partition is not destroyed.
Error: Failed to unmount when inactive. Check if the file system on the data partition is busy.	Unmount during deactivation has failed. Check to see if the file system on data partition is not busy.
Error: Mirror disk resource is on process of activation. Execute after activation is completed.	The mirror disk is in the process of activation. Try after activation is completed.
Error: Failed to perform forced mirror recovery or activate a single server. Check if any hardware error has occurred on the disk.	Performing forced recovery or activating a standalone server has failed. Check to see if any hardware error has occurred on the disk.
Error: Entered incorrect maximum number of request queues. Check the specifiable range.	Invalid maximum number of request queues is entered. Check the range of numbers that can be specified.
Error: Failed to set the maximum number of request queues. Reboot the local server.	Setting a maximum number of request queues has failed. Restart the local server.
Error: Failed to acquire the maximum number of request queues. Reboot the local server.	Acquiring a maximum number of request queues has failed. Restart the local server.
Mirror disk resource was not found on local server. Cannot perform this action.	The mirror disk resource was not defined on the local server. Cannot configure the maximum number of request queues. Check the status of the mirror disk resource.
Error: Failed to get the NMP path. Check if the Mirror Agent is operating normally. Reboot the local server.	Check to see if the Mirror Agent is operating normally. Restart the local server.
Error: Failed to acquire the mirror configuration information. Check if the Mirror Agent is operating normally.	Acquiring the mirror configuration information has failed. Check to see if the Mirror Agent is operating normally.
Error: Failed to acquire the mirror disk configuration information. Reboot the local server.	Acquiring mirror disk configuration data has failed. Restart the local server.

Message	Cause/Solution
Error: Failed to acquire the mirror disk configuration information of both local and remote servers. Shut down the cluster and reboot both servers	Acquiring mirroring disk configuration data of both servers has failed. Shut down the cluster and restart both servers.
Error: Failed to get the number of bits of the bitmap due to the errors occurred when acquiring the mirror difference information of the cluster partition. Shut down the cluster. If it fails again, replace the disk. For procedure to replace the disk, see the Reference Guide.	Acquiring the information of mirror differences on the cluster partition has failed. Shut down the cluster. If the error occurs again, replace the disk. For information on how to replace a disk, see Chapter 10 "The system maintenance information" in this guide.
Error: The number of the bits in the bitmap is invalid. The mirror difference information of the cluster partition is invalid. Shut down the cluster. If it fails again, replace the disk. For procedure to replace the disk, see Reference Guide.	The information of the mirror differences in the cluster partition is invalid. Shut down the cluster. If the error occurs again, replace the disk. For information on how to replace a disk, see Chapter 10 "The system maintenance information" in this guide.
Error: Failed to read the mirror difference information of the local server. Reboot the local server.	Reading the information of mirror differences on the local server has failed. Restart the local server.
Error: Failed to read the mirror difference information of the other server. Reboot the other server.	Reading the information of the mirror differences on the remote server has failed. Restart the remote server.
Error: Failed to get the bitmap information of the local server due to the errors occurred when acquiring the mirror difference information of the local server. Reboot the local server.	Acquiring the information of the mirror differences on the local server has failed. Restart the local server.
Error: Failed to read the disk space. Shut down the cluster and reboot the server	Acquiring the disk space has failed. Shut down the cluster and restart the server.
Error: Failed to acquire the disk space of the other server. Shut down the cluster and reboot both servers.	Acquiring the disk space of the remote server has failed. Shut down the cluster and restart the server.
Error: Setting of cluster partition failed. Restart local server.	Configuring the cluster partition has failed. Restart the local server.
Error: Error occurred on the settings of the mirror disk resource. Reboot the local server.	Error occurred in the status settings of mirror disk resource. Restart the local server.
Error: Failed to create a thread. Reboot the local server.	Creating thread has failed. Restart the local server.
Error: Internal error. Failed to create process. Reboot the local server.	Creating the process has failed. Restart the local server.
Error: Failed to acquire semaphore. Reboot the local server.	Acquiring semaphore has failed. Restart the local server.
Error: A malloc error. Failed to reserve the memory space. Reboot the local server.	Reserving memory has failed. Restart the local server.
Error: Mirror driver of the local server is not loaded. Confirm kernel version.	The mirror driver of the local server is not loaded. Check the kernel version.
Error: Mirror recovery cannot be executed as NMP size of mirror recovery destination is smaller than the size of where the mirror is recovered from. Change the recovery destination and try again.	Mirror recovery cannot be performed because NMP size of recovery destination is smaller than the recovery source. Change the destination and try again.

Message	Cause/Solution
Error: NMP size of local server is bigger, cannot active. Initial mirror configuration is not completed. Execute mirror recovery from server of smaller NMP size to that of larger one.	Initial mirror configuration is not completed. Perform forced mirror recovery from the server whose NMP size is smaller to the larger one.
Local and remote recovery mode do not match. Reboot a server other than the master server to keep the same contents of configuration file among servers. Note that a failover may occur at server reboot.	The both servers are different on the recovery mode. The recovery is not performed. Restart the servers other than master server to make the information file be the same among servers. Note that a failover may occur at server reboot.
Failed to get remote recovery mode. Recovery will not be interrupted. Check the communication status of mirror connect.	Failed to get remote recovery mode. Recovery will not be interrupted. Check the communication status of mirror connect.
Failed to get local recovery mode. Recovery will not be interrupted. Note that a failover may occur at server reboot.	Failed to get local recovery mode. Recovery will not be interrupted. Restart the local server. Note that a failover may occur when the server is restarted.
Local or remote mirror is forced activated. Cannot perform this action.	Mirror disks are forcibly activated. Cannot perform the mirror recovery. Check the status of local or remote mirror.
The recovery destination of mirror disk is activated. Cannot perform this action.	The recovery destination of mirror disk is activated. Cannot perform the mirror recovery. Check the status of the mirror disk.
Mirror disk connection is disconnected. Cannot perform this action.	The communication status of mirror disk connect is error. Cannot perform the mirror recovery. Check the status of the mirror disk connect.
Failed to get mirror disk list and failed to set all NMP sync flag. Reboot the local server. Note that a failover may occur at server reboot.	The setting of synchronizing data for all the mirror disks failed since acquiring the mirror disk list failed. Reboot the local server. Note that a failover may occur at server reboot.
Failed to get mirror disk list and failed to set all NMP sync flag to OFF. Reboot the local server. Note that a failover may occur at server reboot.	The setting of not to synchronize data for all the mirror disks failed since acquiring the mirror disk list failed. Reboot the local server. Note that a failover may occur at server reboot.
Failed to set sync flag on both servers. Shut down a cluster and reboot server.	The setting of synchronizing data failed on the both servers. Shut down the cluster and restart it.
Failed to set sync flag to OFF on both servers. Shut down a cluster and reboot server.	The setting of not to synchronize data failed on the both servers. Shut down the cluster and restart it.

Message	Cause/Solution
<p>%1: Succeeded to set sync flag ON on %2 Failed to set sync flag ON on %3 Check the communication status of mirror connect</p>	<p>The setting of synchronizing data of %1 succeeded on the server %2, failed on the server %3.</p> <p>Check the running status of the server or the communication status of the mirror disk connect.</p> <p>The mirror disk resource name is displayed where %1 is represented.</p> <p>The server name of which the setting succeeded is displayed where %2 is represented.</p> <p>The server name of which the setting failed is displayed where %3 is represented.</p>
<p>%1: Succeeded to set sync flag OFF on %2 Failed to set sync flag OFF on %3 Check the communication status of mirror connect</p>	<p>The setting of not synchronizing data of %1 succeeded on the server %2, failed on the server %3.</p> <p>Check the running status of the server or the communication status of the mirror disk connect.</p> <p>The mirror disk resource name is displayed where %1 is represented.</p> <p>The server name of which the setting succeeded is displayed where %2 is represented.</p> <p>The server name of which the setting failed is displayed where %3 is represented.</p>
<p>Succeeded to set sync flag on remote server and failed on local server. Note that a failover may occur at server reboot.</p>	<p>The setting of synchronizing data failed on the local server, yet succeeded in the other server. Restart the local server. Note that a failover may occur when the server is restarted.</p>
<p>Succeeded to set sync flag to OFF on remote server and failed on local server. Note that a failover may occur at server reboot.</p>	<p>The setting of not to synchronize data failed on the local server, yet succeeded in the other server. Restart the local server. Note that a failover may occur when the server is restarted.</p>
<p>Cannot change the settings of sync status during mirror recovery. Change the settings after mirror recovery is completed.</p>	<p>The setting of synchronizing data cannot be changed during mirror recovery. Change the settings after mirror recovery is completed.</p>
<p>Mirror disk resource was not found on local server. Cannot perform this action.</p>	<p>The mirror disk resource is not defined on the local server. The setting of synchronizing data cannot be changed.</p>
<p>The status of the mirror disk does not satisfy the conditions to perform this action. A probable cause: 1. Local mirror disk is not initialized or is already force activated. 2. Local mirror disk is not RED or remote is GREEN or remote is already activated.</p>	<p>The status of mirror is invalid. Cannot perform a forced recovery.</p>
<p>The data of mirror disk in the local server may not be the latest. Do you still want to continue? (Y/N)</p>	<p>The data of the local server may not be the latest. Cannot check the status of mirror disk on the other server.</p>
<p>Forced recovery has completed successfully.</p>	<p>The forced mirror recovery has successfully completed.</p>
<p>The status of mirror disk in local server is not GREEN or is already activated. Cannot perform this action.</p>	<p>The status of mirror is invalid. Cannot disconnect a mirror.</p>
<p>Failed to set an isolate flag in the local server.</p>	<p>Cannot update the flag for mirror disconnect.</p>

Message	Cause/Solution
Isolated completed successfully.	The mirror disconnect is successfully completed.
The status of the mirror disk does not satisfy the conditions to perform this action. A probable cause: 1. Mirror disk is not initialized or is not RED. 2. Mirror disk is already activated.	The status of mirror is invalid. Cannot perform the forced activation.
sync flag of %1 is successfully set to ON.	The data synchronization is set to on for %1. A name of the mirror disk resource is displayed where %1 is represented.
Failed to set sync flag of %1 on both servers. Shut down the cluster and reboot server.	Failed to set the data synchronization flag on the both servers. A name of the mirror disk resource is displayed where %1 is represented.
%3: Succeeded to set sync flag ON on %1 Failed to set sync flag ON on %2 Check the communication status of mirror connect.	Failed to set the data synchronization flag on either of the servers. Check if the mirror disk connect can properly communicate. A name of the successfully-set server is displayed where %1 is represented. A name of the faulty-set server is displayed where %2 is represented. A name of the mirror disk resource is displayed where %3 is represented.
%1: Cannot change the settings of sync status during mirror recovery. Change the settings after mirror recovery is completed.	Cannot change the data synchronization flag during mirror recovery. Change the settings after mirror recovery is completed. A name of the mirror disk resource is displayed where %1 is represented.
sync flag of %1 is successfully set to OFF.	The mirror synchronization is set to off for %1. A name of the mirror disk resource is displayed where %1 is represented.
%3: Succeeded to set sync flag OFF on %1 Failed to set sync flag OFF on %2 Check the communication status of mirror connect.	Failed to set the data synchronization flag on either server. Check if the mirror disk connect can normally communicate. A name of the successfully-set server is displayed where %1 is represented. A name of the faulty-set server is displayed where %2 is represented. A name of the mirror disk resource is displayed where %3 is represented.
The specified mirror disk is not defined on this server.	The specified mirror disk is not defined on the local server.
Failed to acquire the path of mirror device. Check if the Mirror Agent is operating normally. Reboot the local server.	Failed to acquire the device name of the mirror disk. Check if the mirror agent is running.
The disk alias does not match the command.	The resource type of the specified resource name (mirror alias name) is invalid. Use clpmdctrl for md resource, and clphdctrl for hd resource.
Invalid command name.	The command name is invalid. Do not change the file name of the clpmdctrl command.
Failed to get host name.	Acquiring the server name failed.

Message	Cause/Solution
<%1>: mirror broken	The status of mirror is invalid. Target mirror disk is not configuring mirror, or the mirror configuring failed on the process. A name of the mirror disk resource is displayed where %1 is represented.
<%1>: recovery timeout	Mirror recovery timed out. Check if the specified timeout period is appropriate, or if the disk I/O or communication delay is not occurring due to heavy loads. A name of the mirror disk resource is displayed where %1 is represented.
Cannot perform this action.(Device: %1). Check if the Cluster Partition or Data Partition is OK.	Could not operate the mirror disk resource because the mirror disk resource is not running due to abnormality with the cluster partition or data partition.
<%1> : Succeeded to set compress flag ON.	The compression of mirror transfer data of resource %1 was switched on.  The mirror disk resource name is displayed where %1 is represented.
<%1> : Succeeded to set compress flag OFF.	The compression of mirror transfer data of resource %1 was switched off.  The mirror disk resource name is displayed where %1 is represented.
<%1> : Failed to set compress flag ON.	Switching on the compression of mirror transfer data of the resource %1 failed.  The mirror disk resource name is displayed where %1 is represented.
<%1> : Failed to set compress flag OFF.	Switching off the compression of mirror transfer data of the resource %1 failed.  The mirror disk resource name is displayed where %1 is represented.
<%1> : Failed to set compress flag ON on %2.	Switching on the compression of mirror transfer data of the resource %1 failed on the server %2.  Check the running status of the server or the communication status of the mirror disk connection.  The mirror disk resource name is displayed where %1 is represented.  The server name is displayed where %2 is represented.
<%1> : Failed to set compress flag OFF on %2.	Switching off the compression of mirror transfer data of the resource %1 failed on the server %2.  Check the running status of the server or the communication status of the mirror disk connection.  The mirror disk resource name is displayed where %1 is represented.  The server name is displayed where %2 is represented.

Message	Cause/Solution
<p>&lt;%1&gt;: Succeeded to switch mirror disk connection. Now using mdc &lt;priority:%2&gt;.</p>	<p>The mirror disk connection was switched to the mdc of priority number %2 of the resource %1.</p> <p>The mirror disk resource name is displayed where %1 is represented.</p> <p>The number of the priority of the newly used mirror disk connection is displayed where %2 is represented.</p>
<p>Error: There is no need to switch mirror disk connection.</p>	<p>The specified mirror disk connection has already been used. Switching is not needed.</p>
<p>Error: Failed to switch mirror disk connection. The specified mirror disk connection is ERROR.</p>	<p>The specified mirror disk connection was not switched to because it was in the ERROR status.</p>
<p>Error: Failed to switch mirror disk connection. The other mirror disk connections are ERROR.</p>	<p>The other mirror disk connections were not switched to because they all were in the ERROR status.</p>
<p>Error: Failed to switch mirror disk connection.</p>	<p>Switching mirror disk connection failed.</p>
<p>Error: Specified mdc priority does not exist.</p>	<p>The specified priority number is invalid.</p> <p>It has not been defined in the configuration information.</p>



## Initializing mirror disks (clpmdinit command)

**clpmdinit:** the `clpmdinit` initializes a mirror disk.

**Command line:**

```
clpmdinit {--create | -c} normal [mirrordisk-alias]
clpmdinit {--create | -c} quick [mirrordisk-alias]
clpmdinit {--create | -c} force [mirrordisk-alias]
```

---

**Caution:**

Generally you do not need to run this command when constructing or operating a cluster. You should exercise caution when you use this command because the partition used for the data will be initialized.

---

<b>Description</b>	<p>This command initializes the cluster partition of a mirror disk resource.</p> <p>This command creates a file system on the data partition of a mirror disk resource.</p>	
<b>Option</b>	<p>{--create, -c} normal</p> <p>{--create, -c} quick</p> <p>{--create, -c} force</p>	<p>Initializes a cluster partition and creates a file system of the data partition, if necessary.<sup>1</sup></p> <p>The necessity is determined by the magic number set by EXPRESSCLUSTER on the cluster partition.</p> <p>Generally, it is not necessary to run the command with this option.</p> <p>Initializes the cluster partition, if necessary.</p> <p>Whether or not it is necessary to initialize the cluster partition is determined by the magic number set by EXPRESSCLUSTER on the cluster partition.</p> <p>Generally, it is not necessary to run the command with this option.</p> <p>Forcefully initializes the cluster partition and creates a file system of the data partition.</p> <p>This option is used when using the disk that was once used as a mirror disk of EXPRESSCLUSTER again.</p>
<b>Parameter</b>	<i>mirrordisk-alias</i>	<p>Specifies a mirror disk resource name.</p> <p>If this parameter is not specified, the process is performed on all mirror disk resources.</p>
<b>Return Value</b>	<p>0</p> <p>Other than 0</p>	<p>Success</p> <p>Failure</p>

---

<sup>1</sup> Unless “Execute initial mkfs” is selected in the cluster configuration data, the file system will not be created. Section I Detailed reference of EXPRESSCLUSTER functions

**Notes** You should exercise caution when you run this command because the mirror disk will be initialized.

Run this command as the root user.

Do not run other commands, until this command is returned.

When running this command, make sure that the Mirror Agent in all servers in the cluster is stopped. To check the Mirror Agent is stopped on all servers, run the following command:

```
# /etc/init.d/clusterpro_md status
```

In a cluster with more than three nodes, if the server where the command is run is not included in a startup server of a group including mirror disk resources, this command results in error. Do not run this command if the server is not included in a startup server of a group.

**Example of command execution**

**Example 1:** When forcefully initializing the cluster partition because the disk to be used for the mirror disk resource md1 was once used as a mirror disk of EXPRESSCLUSTER:

```
# clpmdinit --create force md1
mirror info will be set as default
the main handle on initializing mirror disk <md1> success
initializing mirror disk complete
```

**Error Messages**

Message	Causes/Solution
Log in as root.	Log on as the root user.
Stop the Mirror Agent.	Stop the mirror agent.
The clpmdinit command is currently running. Execute after it is completed.	This command is running. Run after it is completed.
Invalid mirror-alias. Specify a valid mirror disk resource name.	Specify a valid mirror disk resource name.
The mirror disk resource was not found. Set the mirror disk resource properly.	The mirror disk resource was not found. Set a mirror disk resource properly.
Specified mirror disk resource <%1> was not found. Specify a valid mirror disk resource name.	The specified mirror disk resource was not found. Specify a valid mirror disk resource name.
The partition does not exist . Check if the cluster partition of specified mirror disk resource exists (<%1>).	Check to see if the cluster partition of the specified mirror disk resource exists.
Check if the cluster partition size of specified mirror disk resource is larger than 10MB. <%1>	Check to see if the cluster partition size of the specified mirror disk resource is 10 MB or larger.
Internal error (open error <%1>). The cluster partition of the mirror disk resource may not exist or the OS resource may be insufficient.	Check to see if the cluster partition of the specified mirror disk resource exists or OS resource is sufficient.

Message	Causes/Solution
Internal error (<%1> cluster partition: unknown error). Failed to initialize the cluster partition. Check if any hardware error has occurred on the disk.	Initializing the cluster partition has failed. Check to see if there is any hardware error on the disk.
Internal error (<%1> cluster partition: %2). Check if the size of cluster partition is sufficient and any hardware error has occurred on the disk.	Setting a cluster partition has failed. Check to see if the cluster partition space is sufficient and a hardware error has not occurred on the disk.
The data partition does not exist (<%1>). Check if the data partition of the specified mirror disk resource exists. Data Partition is: %2	Check to see if the data partition of the specified mirror disk resource exists.
Failed to initialize the cluster partition <%1>. The data partition of the specified mirror disk resource may not exist, hardware error may have occurred on the disk, or specified file system may not be supported by OS. Check them. mirror<%2>: fstype<%3>	Initializing the data partition has failed. Check to see if the data partition of the specified mirror disk resource exists, hardware error has not occurred on the disk and the specified file system is supported by OS.
Unknown error occurred when formatting mirror-disk<%1>. The data partition of the specified mirror disk resource may not exist or hardware error may have occurred on the disk. Check them.	Initializing the data partition has failed. Check to see if the data partition of the specified mirror disk resource exists and a hardware error has not occurred on the disk.
Internal error (Failed to open the data partition:<%1>). Failed to initialize the data partition. The data partition of the specified mirror disk resource may not exist or OS resource may not be sufficient. Data Partition is: %2	Initializing the data partition has failed. Check to see if the data partition of the specified mirror disk resource exists and OS resource is sufficient.
Internal error (data partition check error---<%1>). Failed to initialize the data partition. Check if any hardware error has occurred on the disk.	Initializing the data partition has failed. Check to see if any hardware error has not occurred on the disk.
Failed to acquire mirror disk list information. Reboot the local server.	Acquiring a list of mirror disk has failed. Restart the local server.
Internal error (PID write failed). Check if memory or OS resources are sufficient.	Check to see if the memory or OS resource is sufficient.
Internal error (initialization failed) Failed to read the configuration file, or failed to initialize the shared memory or semaphore. Check if the file is configured properly and reboot the local server.	Reading the configuration file, initialize the shared memory or semaphore has failed. Check to see if configuration file is correct, and restart the local server.
Internal error (termination failed) Failed to release the shared memory. Check if any system error has occurred while running the program.	Freeing up the shared memory has failed. Check to see if any system error has not occurred while running the program.
A malloc error. Failed to reserve the memory space. Reboot the local server.	Reserving memory space has failed. Restart the local server.

Message	Causes/Solution
An error has occurred when the data partition is set to writable mode. <Device:%1>. Reboot the local server.	An error occurred when the data partition was set to the writable mode. Restart the local server.
An error has occurred when the data partition is set to read-only mode.<Device:%1>. Reboot the local server.	An error occurred when the data partition was set to the read-only mode. Restart the local server.
Cluster Partition or Data Partition does not exist.	No cluster partition or data partition exists. Check if a partition is created.
Failed to upgrade the cluster partition of <%s>.	Upgrading a cluster partition failed. Check if there is an error on the disk.
Specified mirror disk resource was not found on local server. Cannot perform this action.	The mirror disk resource is not defined on the local server. Cannot perform initialization. Check the status of the mirror disk resource.
The disk alias does not match the command.	The resource type of the specified resource name (mirror alias name) is invalid. Use clpmdinit for md resource, and clphdinit for hd resource.
Invalid command name.	The command name is invalid. Do not change the file name of the clphdinit command.
Initializing mirror disk of %1 failed. Check if the Cluster Partition or Data Partition is OK.	Failed to initialize the mirror disk resource because the cluster partition or the data partition is abnormal.

## Hybrid-disk-related commands

### Displaying the hybrid disk status (`clphdstat` command)

**clphdstat:** the `clphdstat` command displays status related to mirroring and configuration information.

**Command line:**

```
clphdstat {--connect | -c} hybriddisk-alias
clphdstat {--mirror | -m} hybriddisk-alias
clphdstat {--active | -a} hybriddisk-alias
clphdstat {--detail | -d} hybriddisk-alias
clphdstat {--list | -l}
clphdstat {--perf | -p} [interval [count]] hybriddisk-alias
```

<b>Description</b>	This command displays the status related to mirroring of hybrid disk. This command displays hybrid disk resources configuration information.	
<b>Option</b>	<code>--connect, -c</code>	Displays the status of mirror connect used by hybrid disk resource.
	<code>--mirror, -m</code>	Displays the mirroring status of hybrid disk resource.
	<code>--active, -a</code>	Displays status of hybrid disk resource activation.
	<code>--detail, -d</code>	Displays hybrid disk resources configuration information.
	<code>--list, -l</code>	Displays hybrid disk resources list.
	<code>--perf</code>	Displays statistical information on hybrid disk resources.
<b>Parameter</b>	<i>hybriddisk-alias</i>	Specifies a hybrid disk resource name.
	<i>interval</i>	Specifies the sampling interval for statistical information. If no value is specified, 60 (sec) is specified by default. You can specify a value from 1 to 9999.
	<i>count</i>	Specifies the number of times statistical information is displayed. This parameter is used together with the <i>interval</i> . You can specify a value from 1 to 9999. When <i>count</i> is omitted, statistical information displays indefinitely. To stop displaying statistical information, press [Ctrl] + [C]. Both the default value of <i>interval</i> , 60, and of <i>count</i> , 1, are used if these parameters are omitted.
<b>Return value</b>	0	Success
	Other than 0	Failure
<b>Notes</b>	Run this command as the root user.	

If there is no current server in the server group, the server in which a mirror agent is working normally becomes the current server. The server having the highest priority in server priority in **Server Group Properties** is selected.

**Example display after running this command**

An example of the display after running this command is provided in the next section.

### Error Messages

Message	Cause/Solution
Error: Log in as root.	Log on as the root user.
Error: Failed to read the configuration file. Check if it exists or is configured properly.	Reading the configuration file has failed. Check to see if the configuration file exists and is configured correctly.
Error: Failed to acquire hybrid disk resource name. Check if the Mirror Agent is operating normally.	Acquiring a hybrid disk resource name has failed. Check to see if the Mirror Agent is operating normally.
Error: Specified hybrid disk resource was not found. Specify a valid hybrid disk resource name.	Failed to the specified hybrid disk resource. Specify a valid mirror disk resource name.
Error: Invalid hybrid-alias. Specify a valid hybrid disk resource name.	Specify a valid hybrid disk resource name.
Error: Failed to get the server name. Check if the configuration file is correct and the Mirror Agent is operating normally.	Acquiring a server name has failed. Check to see if the configuration file is valid and the Mirror Agent is operating normally.
Error: Failed to communicate with other servers. Check if the Mirror Agent of the other server is operating normally and the interconnect LAN is connected.	Communicating with the remote server has failed. Check if the Mirror Agent in the remote server is operating normally and the interconnect is connected.
Error: Hybrid disks of the remote server may be down. Check if the Mirror Agent of the remote server is operating normally and the interconnect LAN is connected.	Communicating with the remote server has failed. Check to see if the Mirror Agent in the remote server is operating normally, and the interconnect is connected.
Error: Failed to get the hybrid disk status. Check if the Mirror Agent on the local server is operating normally.	Acquiring the hybrid disk status has failed. Check to see if the Mirror Agent in the local server is operating normally.
Error: Failed to acquire the mirror index. Check if the Mirror Agent is operating normally.	Check to see if the Mirror Agent is operating normally.
Error: mirror agent is not running Check if the Mirror Agent is active.	The Mirror Agent is not started up. Check the syslog or the alert message of the module type, mdagent.
Error: Failed to acquire the active status of the Mirror Agent of the local server. Shut down the cluster and reboot both servers	Acquiring the active status of mirror disk resource of the local server has failed. Shut down the cluster and restart both servers.
Error: Failed to acquire the active status of the Mirror Agent of the other server. Shut down the cluster and reboot both servers	Acquiring the active status of a mirror disk resource of the remote server has failed. Shut down the cluster and restart both servers.
Error: Failed to acquire mirror recovery status. Reboot the local server.	Acquiring the mirror recovery status has failed. Restart the local server.

Message	Cause/Solution
Error: Failed to acquire the list of hybrid disks. Reboot the local server.	Acquiring a list of hybrid disks has failed. Restart the local server.
Error: Failed to acquire the mirror configuration information. Check if the Mirror Agent is operating normally.	Acquiring the mirror configuration data has failed. Check to see if the Mirror Agent is operating normally.
Error: Failed to acquire the hybrid disk configuration information of both servers. Shut down the cluster and reboot both servers	Acquiring the hybrid disk configuration data of both servers failed. Perform cluster shut down and restart both servers.
Error: The number of the bits of the bitmap is invalid. The mirror difference information of the cluster partition is invalid. Shut down the cluster. If it fails again, replace the disk. For procedure to replace the disk, see the Reference Guide.	Acquiring the mirror difference information in the cluster partition has failed. Shut down the cluster. If this error happens again, replace the disk.
Error: Failed to get bitmap information. Failed to acquire the mirror difference information of the local server. Reboot the local server.	The mirror difference information in the cluster partition is invalid. Shut down the cluster. If this error happens again, replace the disk.
Error: Failed to get bitmap information. Failed to acquire the mirror difference information of the local server. Reboot the local server.	Acquiring the mirror difference information has failed of the local server. Restart the local server.
Error: Failed to read the mirror difference information of the local server. Reboot the local server.	Reading the mirror difference information of the local server has failed. Restart the local server.
Error: Failed to acquire semaphore. Reboot the local server.	Acquiring semaphore has failed. Restart the local server.
Error: A malloc error. Failed to reserve the memory space. Reboot the local server.	Reserving memory space has failed. Restart the local server.
Error: Mirror driver of the local server is not loaded. Refer to the Reference Guide to load the driver.	The mirror driver in the local server is not loaded. Check this by referring to Chapter 11 "Troubleshooting" in this guide.
Error: Internal error (errorcode: 0xxxx). Shut down the cluster and reboot the server.	Shut down the cluster and restart the server.
Error: Failed to communicate with server %1 and %2. Check if both Mirror Agents of the two servers are operating normally and the interconnect LANs are connected.	Failed to communicate with both servers represented in the message. Make sure that the mirror agents of both servers are running and the interconnect LANs are connected.  The server names are displayed where "%1" and "%2" are represented.
Error: Failed to communicate with server %1. Check if Mirror Agent of the server is operating normally and the interconnect LAN is connected. Failed to acquire the hybrid disk detail information of the server %2. Shut down the cluster and reboot both servers.	Failed to communicate with the server %1. Check if the Mirror Agent of the other server is running and the interconnect LAN is connected.  Failed to acquire the hybrid disk detail information of the server %2. Shut down the cluster, and then restart the both servers.  The server names are displayed where "%1" and "%2" are represented.

Message	Cause/Solution
<p>Error: Failed to acquire the hybrid disk detail information of the server %1. Shut down the cluster and reboot both servers.</p> <p>Failed to communicate with server %2. Check if Mirror Agent of the server is operating normally and the interconnect LAN is connected.</p>	<p>Failed to acquire the hybrid disk detail information of the server %1. Shut down the cluster, and then restart the both servers.</p> <p>Failed to communicate with the server %2. Check if the Mirror Agent of the other server is running and the interconnect LAN is connected.</p> <p>The server name is displayed where “%1” or “%2” is represented.</p>
<p>Error: Failed to acquire the hybrid disk detail information of the server %1 and server %2. Shut down the cluster and reboot both servers."</p>	<p>Failed to acquire the hybrid disk detail information of both servers. Shut down the cluster, and then restart the servers.</p> <p>The server name is displayed where “%1” or “%2” is represented.</p>
<p>Error: Failed to communicate with server %1. Check if Mirror Agent of the server is operating normally and the interconnect LAN is connected.</p> <p>Failed to acquire mirror disk %3 net interface status of the server %2. Shut down the cluster and reboot both servers.</p>	<p>Failed to communicate with the server %1. Check if the Mirror Agent of the other server is running and the interconnect LAN is connected.</p> <p>Failed to acquire the status of mirror disk connect of mirror disk resource %3 of server %2. Shut down the cluster and reboot both servers.</p> <p>The server name is displayed where “%1” or “%2” is represented.</p> <p>Where %3 is represented, the hybrid resource name is displayed.</p>
<p>Error: Failed to acquire hybrid disk %3 net interface status of the server %1. Shut down the cluster and reboot both servers.</p> <p>Failed to communicate with server %2 . Check if Mirror Agent of the server is operating normally and the interconnect LAN is connected.</p>	<p>Failed to acquire the status of hybrid disk connect of mirror disk resource %3 of server %1. Shut down the cluster and reboot both servers.</p> <p>Failed to communicate with the server %2. Check if the Mirror Agent of the other server is running and the interconnect LAN is connected.</p> <p>The server name is displayed where “%1” or “%2” is represented.</p> <p>Where %3 is represented, the hybrid resource name is displayed.</p>
<p>Error: Failed to acquire mirror disk %3 net interface status of the server %1 and server %2. Shut down the cluster and reboot both servers.</p>	<p>Failed to acquire the status of hybrid disk connect of both servers. Shut down the cluster, and then, restart the servers.</p> <p>The server name is displayed where “%1” or “%2” is represented.</p> <p>Where %3 is represented, the hybrid resource name is displayed.</p>
<p>Error: Failed to communicate with server %1. Check if Mirror Agent of the server is operating normally and the interconnect LAN is connected.</p> <p>Failed to acquire the active status of the Hybrid disk %3 of the server %2. Shut down the cluster and reboot both servers.</p>	<p>Failed to communicate with the server %1. Check if the Mirror Agent of the other server is running and the interconnect LAN is connected.</p> <p>Failed to acquire the active status of the Hybrid disk resource %3 of the server %2. Shut down the cluster and reboot both servers.</p> <p>The server name is displayed where “%1” or “%2” is represented.</p> <p>Where %3 is represented, the hybrid resource name is displayed.</p>



Message	Cause/Solution
Error: Failed to acquire the active status of the Hybrid Mirror disk %3 of the server %1. Shut down the cluster and reboot both servers. Failed to communicate with server %2 . Check if Mirror Agent of the server is operating normally and the interconnect LAN is connected.	Failed to acquire the active status of the hybrid disk resource %3 of the server %1. Shut down the cluster and reboot both servers.  Failed to communicate with the server %2. Check if the Mirror Agent of the other server is running and the interconnect LAN is connected.  Where %1 or %2 is represented, the server name is displayed.  Where %3 is represented, the hybrid resource name is displayed.
Error: Failed to acquire the active status of the Hybrid disk %3 of the server %1 and server %2. Shut down the cluster and reboot both servers.	Failed to acquire the hybrid disk detail information of both servers. Shut down the cluster, and then restart the servers.  Where %1 or %2 is represented, the server name is displayed.  Where %3 is represented, the hybrid resource name is displayed.
Error: Failed to get all server names. Check if the configuration file is correct and the Mirror Agent is operating normally.	Failed to acquire the server name. Check if the configuration file is correct and the Mirror Agent is operating normally.
Error: The disk alias does not match the command.	The resource type of the specified resource name (mirror alias name) is invalid. Use clpmdstat for md resource, and clphdstat for hd resource.
Error: Invalid command name.	The command name is invalid. Do not change the file name of the clphdstat command.
Error: This server is not current server. Cannot perform this action.	This command cannot be executed because this server is not current server.
Error: Hybrid disk internal error.	An internal error occurred.
Error: The function of collecting statistics is disabled.	The statistical information collection function is disabled. Check the setting of <b>Gather Statistical information</b> on the <b>Mirror Agent</b> tab in <b>Cluster Properties</b> by using the Builder.
Error: Collecting mirror statistics failed. Please retry in a few seconds later.	Failed to collect statistical information because of a temporarily high load or other issue. Wait, and then execute the command again. If this message appears again, make sure that mdagent is running normally.

## Display examples

- ◆ Hybrid disk connect status display

When the `--connect` option is specified, the status of mirror connect that is used by hybrid disk resource is displayed.

```
Hybrid Disk Name : hd1

[Server : server1]
 192.168.0.1           : Using

[Server : server2]
 192.168.0.2           : Using
```

Explanation of each item

Item	Description										
Server Name	Name of the server										
IP Address	IP address specified by hybrid disk connect										
Status	Status of mirror connect										
	<table border="1"> <thead> <tr> <th>Status</th> <th>Description</th> </tr> </thead> <tbody> <tr> <td>Using</td> <td>Being used</td> </tr> <tr> <td>Free</td> <td>Not used</td> </tr> <tr> <td>Error</td> <td>Error</td> </tr> <tr> <td>--</td> <td>Unknown</td> </tr> </tbody> </table>	Status	Description	Using	Being used	Free	Not used	Error	Error	--	Unknown
	Status	Description									
	Using	Being used									
	Free	Not used									
Error	Error										
--	Unknown										

◆ Displaying the status of mirroring of hybrid disk resource

The status of mirroring of the specified hybrid disk resource is displayed by specifying the `--mirror` option.

(1) When the status of mirror disk resource is Normal:

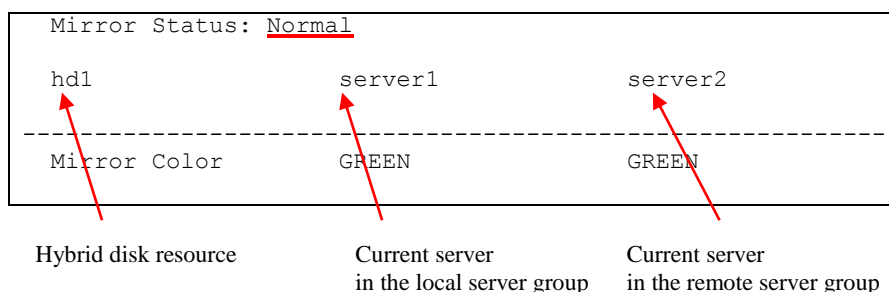

Explanation of each item

Item	Description																
Mirror Status	Mirroring status of hybrid disk resource																
	<table border="1"> <thead> <tr> <th>Status</th> <th>Description</th> </tr> </thead> <tbody> <tr> <td>Normal</td> <td>Normal</td> </tr> <tr> <td>Recovering</td> <td>Mirror is recovering</td> </tr> <tr> <td>Abnormal</td> <td>Abnormal</td> </tr> <tr> <td>No Construction</td> <td>Initial mirror construction is not done</td> </tr> </tbody> </table>	Status	Description	Normal	Normal	Recovering	Mirror is recovering	Abnormal	Abnormal	No Construction	Initial mirror construction is not done						
	Status	Description															
	Normal	Normal															
	Recovering	Mirror is recovering															
Abnormal	Abnormal																
No Construction	Initial mirror construction is not done																
Mirror Color	Status of hybrid disk on each server																
	<table border="1"> <thead> <tr> <th>Status</th> <th>Description</th> </tr> </thead> <tbody> <tr> <td>GREEN</td> <td>Normal</td> </tr> <tr> <td>YELLOW</td> <td>Mirror is recovering</td> </tr> <tr> <td>RED</td> <td>Abnormal</td> </tr> <tr> <td>ORANGE</td> <td>Suspension (The server having the latest cannot be determined.)</td> </tr> <tr> <td>GRAY</td> <td>Being stopped, Unknown status</td> </tr> <tr> <td>BLACK</td> <td>Initial mirror construction is not done, error found in cluster partition data, etc.</td> </tr> <tr> <td>BLUE</td> <td>Both disks are active</td> </tr> </tbody> </table>	Status	Description	GREEN	Normal	YELLOW	Mirror is recovering	RED	Abnormal	ORANGE	Suspension (The server having the latest cannot be determined.)	GRAY	Being stopped, Unknown status	BLACK	Initial mirror construction is not done, error found in cluster partition data, etc.	BLUE	Both disks are active
	Status	Description															
	GREEN	Normal															
	YELLOW	Mirror is recovering															
	RED	Abnormal															
	ORANGE	Suspension (The server having the latest cannot be determined.)															
GRAY	Being stopped, Unknown status																
BLACK	Initial mirror construction is not done, error found in cluster partition data, etc.																
BLUE	Both disks are active																

(2) When the status of mirror disk resource is abnormal

Mirror Status: <u>Abnormal</u>		
hd1	server1	server2
-----		
Mirror Color	GREEN	RED
Lastupdate Time	2004/02/24 15:41:07	--
Break Time	2004/02/24 15:40:38	--
Disk Error	OK	OK
Difference Percent	1%	--

Explanation of each item

Item	Description								
Mirror Status	Status of hybrid disk resource *1								
Mirror Color	Status of hybrid disk on each server *1								
Last update Time	Last time when the data was updated on the server. This is not displayed when the hybrid disk status is unknown.								
Break Time	Time when mirror break has occurred This is not displayed when the hybrid disk status is unknown.								
Disk Error	Status of disk I/O <table border="1" data-bbox="699 1160 1222 1339"> <thead> <tr> <th>Status</th> <th>Description</th> </tr> </thead> <tbody> <tr> <td>OK</td> <td>Normal</td> </tr> <tr> <td>ERROR</td> <td>Error (No I/O)</td> </tr> <tr> <td>--</td> <td>Unknown</td> </tr> </tbody> </table> This is not displayed when the hybrid disk status is unknown.	Status	Description	OK	Normal	ERROR	Error (No I/O)	--	Unknown
Status	Description								
OK	Normal								
ERROR	Error (No I/O)								
--	Unknown								
Difference Percent	Percentage of differences in the data on each server. This is not displayed when the hybrid disk status is unknown.								

\*1 See "Explanation of each item" in "When the status of mirror disk resource is Normal:" on page 495.

(3) During mirror recovery

Mirror Status: <u>Recovering</u>		
hd1	server1	server2
-----		
Mirror Color	YELLOW	YELLOW
Recovery Status Value		
-----		
Status:	Recovering	
Direction: src	server1	
dst	server2	
Percent:	3%	
Used Time:	00:00:01	
Remain Time:	00:00:32	
Iteration Times:	1/1	

Explanation of each item

See "Explanation of each item" of the clpmdstat command on page 465.

◆ Displaying active status of hybrid disk resource

Active status of the specified hybrid disk resource is displayed when the --active option is specified:

hd1	server1	server2
-----		
Active Status	Active	Inactive

Hybrid disk resource                      Current server name  
in the local server                      Current server name  
in the remote server group

Status of mirror partition device

See "Status of mirror partition device" of the clpmdstat command on page 466.

◆ Displaying hybrid disk resource information

Configuration information of the specified hybrid disk resource is displayed when the `--detail` option is specified:

```

Hybrid Disk Name : hdl
  Sync Switch      : On
  Sync Mode       : Sync
  Diff Recovery   : Disable
  Compress        :
    Sync Data     : Off
    Recovery Data : Off

[Server : server1]
  NMP/Disk Size(MB) : 2447/2447
  DP Device        : /dev/sdb2
  CP Device        : /dev/sdb1

[Server : server2]
  NMP/Disk Size(MB) : 2447/2447
  DP Device        : /dev/sdb2
  CP Device        : /dev/sdb1
    
```

Explanation of each item

Item	Description
Hybrid Name	Hybrid disk resource name
Sync Switch	Perform data synchronization
Sync Mode	Synchronization Mode
Server Name	Current server name
NMP/Disk Size(MB)	NMP: the smaller size of data partition of servers Disk Size: actual data partition size
DP Device	Data partition device name
CP Device	Cluster partition device name

◆ Displaying the list of hybrid disk resources

The list of hybrid disk resources is displayed when the `--list` option is specified:

```
[HybridDisk Option]
server1 : Installed
server2 : Installed
server3 : Installed

[Servers Which Can Be Started]
<hd1>
  [ServerGroup0 : server_group1]
  *server1
  server2
  [ServerGroup1 : server_group2]
  *server3
<hd2>
  [ServerGroup0 : server_group1]
  server1
  *server2
  [ServerGroup1 : server_group2]
  *server3
```

Explanation of each item

Item	Description
HybridDisk Option	License status of the Replicator DR
Servers Which Can Be Started	The server group of the hybrid disk resource and servers that can be started
*	Current server of each server group

◆ Displaying statistical information

See “Displaying statistical information” of the `clpmdstat` command on page 468.

## Operating hybrid disk resource (clphdctrl command)

**clpmdctrl:** the `clpmdctrl` command operates hybrid disk resources.

### Command line:

```
clphdctrl {--active | -a} hybriddisk-alias
clphdctrl {--active | -a} -nomount hybriddisk-alias
clphdctrl {--active | -a} -force [-ro] hybriddisk-alias
clphdctrl {--active | -a} -force -nomount hybriddisk-alias
clphdctrl {--deactive | -d} hybriddisk-alias
clphdctrl {--break | -b} hybriddisk-alias
clphdctrl {--force | -f} [-v] recovery-source-servername
hybriddisk-alias
clphdctrl {--force | -f} hybriddisk-alias
clphdctrl {--recovery | -r} hybriddisk-alias
clphdctrl {--cancel | -c} hybriddisk-alias
clphdctrl {--rwait | -w} [-timeout time [-rcancel]] hybriddisk-alias
clphdctrl --getreq
clphdctrl --setreq request-count
clphdctrl --sync [hybriddisk-alias]
clphdctrl --nosync [hybriddisk-alias]
clphdctrl --setcur [hybriddisk-alias]
clphdctrl {--compress | -p} [hybriddisk-alias]
clphdctrl {--nocompress | -n} [hybriddisk-alias]
clphdctrl {--mdcswitch | -s} [mdc-priority] hybriddisk-alias
```

---

### Note:

Do not use the `--active`, and `--deactive` options when the cluster daemon is started. If you use them, the data in file system can be corrupted. Do not use these options for the purposes other than those mentioned in Chapter 9, “Preparing to operate a cluster system” in the *Installation and Configuration Guide*.

---

<b>Description</b>	This command activates, deactivates or forcibly activates hybrid disk resource and recovers or forcibly recovers mirror.  This command disconnects a hybrid disk.  This command performs mirror recovery, forced mirror recovery, cancellation of mirror recovery, and waiting for the completion of mirror recovery.  This command displays and/or modifies the settings of maximum number of request queues.  This command switches the synchronization status of the mirror data.  This command acquires the current right of hybrid disk resource.  This command is used to set whether mirror data is to be compressed.  This command switches the communication path (mirror disk connect) to be used.
--------------------	--------------------------------------------------------------------------------------------------------------------------------------------------------------------------------------------------------------------------------------------------------------------------------------------------------------------------------------------------------------------------------------------------------------------------------------------------------------------------------------------------------------------------------------------------------------------------------------------------------------------------------------------------------------------------------------------------------------------------------------------------------



Option		
	<code>--active, -a</code>	<p>Activates the hybrid disk resource on the local server.</p> <p>If the status of hybrid disk resource is normal, mirroring is performed.</p> <p>If the status of hybrid disk resource is not normal, mirroring will not be performed.</p>
	<code>-force</code>	<p>Forcibly activates a hybrid disk resource. This command can be run on a server where mirroring is stopped.</p>
	<code>-nomount</code>	<p>It allows access to hybrid partition device without mounting the file system.</p> <p>This option is used with the <code>--active</code> option.</p>
	<code>-ro</code>	<p>Forcibly activates a mirror disk resource in ReadOnly mode.</p> <p>This option is used with the <code>--active -force</code> options.</p>
	<code>--deactivate, -d</code>	<p>Deactivates the activated hybrid disk resource on the local server.</p>
	<code>--break, -b</code>	<p>Disconnects the hybrid disk resources forcibly specified with <i>hybriddisk-alias</i> on the server where the command is run. The status of the hybrid disk resource on the server where the command is run becomes an error. The status of the hybrid disk resource on the server where the command is not run does not change.</p> <p>When a mirror is recovered, disconnection is canceled.</p> <p>Hybrid disk data is not synchronized even when any data is written to a hybrid disk.</p> <p>Auto mirror recovery is not automatically started until reboot is performed or disconnection is canceled after completion of mirror recovery.</p>
	<code>--recovery, -r</code>	<p>Performs either full mirror recovery or differential mirror recovery for the specified hybrid disk resource.</p> <p>Whether to perform full or differential mirror recovery is determined automatically.</p>
	<code>--force, -f</code>	<p>Forcefully performs mirror recovery for the specified hybrid disk resource.</p> <p>If only <i>hybriddisk-alias</i> is specified, the status of the hybrid disk where the command is run becomes normal forcibly. Mirror resynchronization is not performed.</p> <p>If <i>recovery-source-servername</i> and <i>hybriddisk-alias</i> are specified, full mirror recovery is performed using <i>recovery-source-servername</i> as source data. The status of the hybrid disk becomes normal when the full mirror recovery completes.</p>
	<code>-v</code>	<p>Forcefully performs mirror recovery without an analysis of the file system.</p>

<code>--cancel, -c</code>	<p>Cancels mirror recovery.</p> <p>If auto mirror recovery is set to ON and the hybrid disk monitor resource is operating, mirror recovery will be automatically restarted a short while after mirror recovery is canceled. In this case, first suspend the hybrid disk monitor resource with either WebManager or the <code>clpmonctrl</code> command and then cancel mirror recovery.</p>
<code>--rwaitm, -w</code>	<p>Waits for the completion of the mirror recovery of the specified disk resource.</p>
<code>-timeout</code>	<p>Specifies the timeout period of mirror recovery completion (second). This option can be omitted. When this option is omitted, timeout is not executed and waits for the completion of mirror recovery.</p>
<code>-rcancel</code>	<p>Cancels mirror recovery when the timeout of waiting of mirror recovery completion occurred. This option can be set when <code>-timeout</code> option is set. When this option is omitted, the mirror recovery continues even after the timeout occurrence.</p>
<code>--getreq</code>	<p>Displays the current maximum number of request queues.</p>
<code>--setreq</code>	<p>Configures the maximum number of request queues.</p> <p>When the server shuts down, what you have configured here returns to the value set in the cluster configuration data. Use the Builder if you want to modify the cluster configuration data. For details, see “Cluster properties Mirror driver tab” in Chapter 2 “Functions of the Builder”.</p> <p>The command is only effective on the server that runs the command.</p>
<code>--sync</code>	<p>This option switches the operation to the mirror synchronization.</p> <p>When the hybrid disk resource name is not specified, the operation is switched to synchronizing the mirror data to all hybrid resources.</p>

<code>--nosync</code>	<p>This option switched the operation to the one that does not synchronize the mirror data.</p> <p>When the hybrid disk resource name is not specified, the operation is switched to not performing the synchronization of the mirror data to all hybrid resources.</p> <p>However, the data updated to a disk during a mirror recovery is synchronized to a standby server.</p> <p>If auto mirror recovery is set to ON and the mirror disk monitor resource is operating, automatic mirror recovery will operate.</p> <p>Even after the completion of mirror recovery, the operation will still not synchronize. To cancel this, execute the command with the <code>--sync</code> option specified.</p> <p>When the server is shut down, the state will return to the synchronization operation that is set in the cluster configuration information. To change the cluster configuration information, use the Builder. For details, see “Mirror tab” in “Mirror disk resource tuning properties” in “Displaying and changing the details of mirror disk resource” in “Understanding mirror disk resources” in Chapter 4, “Group resource details” in this guide.</p>
<code>--setcur</code>	<p>This option acquires the current right of hybrid disk resource specified by <i>hybriddisk-alias</i> on the server on which the command is executed.</p>
<code>--compress, -p</code>	<p>Temporarily switches on the compression mode of mirror transfer data.</p> <p>If the synchronous mode of mirror data is “Synchronous”, only the recovery transfer data is compressed.</p> <p>If the synchronous mode of mirror data is “Asynchronous”, both the asynchronous transfer data and the recovery transfer data are compressed.</p> <p>When the hybrid disk resource name is not specified, the operation is performed to all hybrid disk resources.</p>
<code>--nocompress, -n</code>	<p>Temporarily switches off the compression mode of mirror transfer data.</p> <p>When the mirror disk resource name is not specified, the operation is performed to all hybrid disk resources.</p>

	<code>--mdcswitch,</code> <code>-s</code>	Switches the mirror connection to another mdc that has the specified priority. If the priority is not specified, the mirror connection is switched to the mdc that has the next highest priority after the current mdc. If the mirror connection is connected to the mdc that has the lowest priority, it is switched to the one that has the highest priority. If the mirror connection has already been switched to the specified mdc, the command terminates normally without performing any processing. If the specified mdc does not exist, an error occurs.
<b>Parameter</b>	<code>recovery-source-servername</code>  <code>hybriddisk-alias</code>  <code>request-count</code>  <code>time</code>  <code>mdc-priority</code>	Specifies a server name of the copy source.  Specifies a hybrid disk resource name.  Specifies a maximum number of request queues. You can specify a number from 256 through 65535.  Specifies the timeout period of mirror recovery completion (seconds).  Specifies the priority of mdc. This is not the priority number of mdc in whole cluster, but the priority number (1 or 2) of mdc used by the hybrid disk resource.
<b>Return Value</b>	0 255 (-1) 254 (-2)  253 (-3)	Success Failure Target disk is not configuring mirror, or the mirror configuring failed on the process. (Only when <code>--rwait</code> option is specified, including the case when mirror recovery is interrupted by <code>-rancel</code> .)  Timeout of mirror recovery of target disk occurs (Only when <code>--rwait -timeout</code> option is specified)
<b>Remarks</b>	<code>request-count</code> , which is displayed by specifying the <code>--getreq</code> option, is the same as “Max. Number of Request Queues” which is displayed by using the <code>clpstat</code> command.  <b># clpstat --cl -detail</b>	This command returns control when the specified processing starts. Run the <code>clphdstat</code> command to check the processing status.
<b>Notes</b>	Run this command as the root user.  <code>--active/--force</code> (Forced mirror recovery) / <code>--setcur</code> can be executed on a server that has a current right or that can have a current right. You can execute <code>--recovery</code> or <code>--force</code> (full mirror recovery with <code>recovery-source-servername</code> specified) in the following condition.  - The server of copy source has the current right or can have a current right.	

- The server of copy target has the current right or can have a current right.

(Mirror recovery cannot be performed on the server without current right in the cluster where hybrid mirror disk resource is configured on the shared disk.)

`--break/--cancel/--setreq/--sync/--nosync/--setreq` can be executed on the server that has a current right.

For further information on the conditions for using this command to change the current server, see "List of operations to switch a current server" on page 514.

When performing mirror recovery again after mirror recovery failed, specify the same server you used last time for mirror recovery as a copy source.

To resume the forced mirror recovery that was suspended by selecting **Cancel**, use this command for forced mirror recovery.

In a cluster with more than three nodes, if the server where the command is run is not included in a startup server of a group including hybrid disk resources, this command results in error. Do not run this command if the server is not included in a startup server of a group.

If, during mirror synchronization, mirror synchronization is interrupted with either the `--break (-b)` or `--nosync` option or if, during mirror recovery, mirror recovery is interrupted, the file system and application data may prove to be abnormal even if the mirror disk to be synchronized is made accessible by performing forced activation or forced mirror recovery. For details, see "Mirror data reference at the synchronization destination if mirror synchronization is interrupted" in Chapter 5, "Notes and Restrictions" in the *Getting Started Guide*.

**Example of command execution**

**Example 1:** When activating the hybrid disk resource hd1:

```
# clphdctrl --active hd1
<hd1@server1>: active successfully
```

**Example 2:** When deactivating the hybrid disk resource md1:

```
# clphdctrl --deactive hd1
<hd1@server1>: deactive successfully
```

**Example 3:** When disconnecting the hybrid disk resource hd1:

```
# clphdctrl --break hd1
hd1: isolate successfully
```

**Example 4:** When the status of hybrid disks both servers is error, and you need to recover the operation that uses the resource hd1 (group name: failover1) as soon as possible:

```
# clphdctrl --force hd1
The data of mirror disk in local server maybe is not latest.
Do you still want to continue? (Y/N)
```

**Example 5:** When recovering mirroring of the hybrid disk resource hd1 :

```
# clphdctrl --recovery hd1
```

**Example 6:** When setting the maximum number of request queues to 2048:

```
# clphdctrl --setreq 2048
```

current I/O request count <2048>

**Example 7:** When configure the setting that does not perform the data synchronization to the hybrid disk resource hd1:

```
# clphdctrl --nosync hd1
```

### Error Messages

Message	Cause/Solution
Error: Log in as root.	Log on as the root user.
Error: Failed to read the configuration file. Check if it exists or is configured properly.	Reading the configuration file has failed. Check to see if the configuration file exists and is configured correctly.
Error: Specified hybrid disk resource was not found. Specify a valid mirror disk resource name.	Locating the specified hybrid disk resource has failed. Specify a valid hybrid disk resource name.
Error: Invalid hybrid-alias. Specify a valid mirror disk resource name.	Specify a valid hybrid disk resource name.
Error: Failed to get the server name. Check if the configuration file is correct and the Mirror Agent is operating normally.	Acquiring the server name has failed. Check if configuration file is correct and the Mirror Agent is operating normally.
Error: Specified server name was not found. Check if the server name exists in the configuration file.	The specified server name was not found. Check to see if the entered server name exists in the configuration file.
Error: Invalid server name. Specify a valid server name.	Specify a valid sever name.
Error: Failed to communicate with other servers. Check if the Mirror Agent of the other server is operating normally and the mirror disk connect is connected.	Communicating with the remote server has failed. Check to see if the Mirror Agent of the remote server is operating and the mirror disk is connected.
Error: Failed to get the hybrid disk status. Check if the Mirror Agent on the local server is operating normally.	Acquiring the hybrid disk status has failed. Check to see if the Mirror Agent of the local server is operating normally.
Error: Failed to get the mirror index. Check if the Mirror Agent is operating normally.	Check to see if the Mirror Agent is operating normally.
Error: The status of hybrid disk resource of the local server is abnormal.	The hybrid disk resource of the local server has a problem.
Error: Specified hybrid disk resource is already active. Check active status of hybrid disk resource by running the following command: clpmdstat --active <alias>	The specified hybrid disk resource is already activated. Check the status of the hybrid disk resource using the following command. clpmdstat --active <alias>
Error: A hardware error has occurred on the disk. Check the disk.	A hardware error has occurred on the disk. Check the disk.
Error: The sizes of data partition of the servers do not match.	Data partition sizes of both servers do not match.
Error: Specified hybrid disk is not active. Check the active status of hybrid disk resource.	The specified hybrid disk resource is not activated. Check the status of hybrid disk resource.
Error: There is no recovering hybrid disk resource.	There is no hybrid disk under mirror recovery process.

Message	Cause/Solution
Error: Mirror hybrid resource is recovering. Wait until mirror recovery completes.	The hybrid disk resource is under mirror recovery process. Wait until mirror recovery is completed
Error: Failed to cancel the mirror recovery. The system may be highly loaded. Wait for a while and try again.	Stopping mirror recovery has failed. The system may be heavily loaded. Wait for a while and try again.
Error: Performed mirror recovery to the hybrid disk resource that is not necessary to recover the mirror. Run the clpmdctrl--force command if you want to perform forced mirror recovery.	Mirror recovery has been performed on the hybrid disk resource that is in normal status and not requiring mirror recovery. To perform forced mirror recovery, use "clpmdctrl --force."
Error: Specification of the server that is copied from is incorrect. When executing mirror recovery again after a failure end of mirror recovery, specify the same server as the previous one.	The server specified for a copy source is invalid. When performing the mirror recovery again after the mirror recovery has failed, specify the same server that you specified last time for the failed mirror recovery as a copy source.
Error: Forced mirror recovery is required. Run the clphdctrl --force command to perform the recovery.	Forced mirror recovery is necessary. Use "clphdctrl --force" and perform forced mirror recovery.
Error: Server with old data is specified as the server which is copied from. Specify a correct recovery direction.	The server with old data is specified as a copy source. Specify a correct recovery direction.
Error: Failed to acquire mirror recovery status. Reboot the local server.	Acquiring the mirror recovery status has failed. Restart the local server.
Error: Both of the mirrors are not constructed. Initial mirror configuration of the hybrid disks by running the clpmdctrl --force command is necessary.	Initial mirror construction of hybrid disk is necessary. Construct initial mirror configuration using "clphdctrl --force."
Error: Initial mirror configuration of mirror disk of local server is necessary. Specify the other server as the one that is copied from by using the clphdctrl --force command to configure an initial mirror.	Initial mirror construction is necessary for the hybrid disk of the local server. Specify the remote server as a copy source and construct initial mirror using "clphdctrl --force."
Error: Initial mirror configuration of mirror disk of the other server is necessary. Specify the local server as the one that is copied from by using the clphdctrl--force command to configure an initial mirror.	Initial mirror construction is necessary for the hybrid disk of the remote server. Specify the local server as a copy source and construct initial mirror using "clphdctrl --force."
Error: Mirror flag error. Use "clphdinit" to construct the mirror. The status of cluster partition of the hybrid disk resource is abnormal. When the server with the error has the latest data, backup the data, initialize the cluster partition, and replace the same disk by using the same disk. If the error persists, change the disk to new one.	The cluster partition of the hybrid disk resource has a problem. When the server with error has the latest data, back up the data, initialize the cluster partition, and follow the same "disk replacement" steps using the same disk by referring to "Backup Procedure" and "Restoration Procedure" in Chapter 8 "Verifying Operation" in the <i>Installation and Configuration Guide</i> . If this occurs again, replace the disk with a new disk.
Error: Both local and remote mirrors are active. Shut down the cluster and execute forced mirror recovery after rebooting the server.	Both systems are active. Shut down the cluster and perform forced mirror recovery after reactivating the server.
Error: Mirror Agent is not running. Check if the Mirror Agent is active.	The Mirror Agent is not started up. Check to see if the Mirror Agent is running.

Message	Cause/Solution
Error: System calls error. Failed to run the system command when active and/or inactive. Check if the search path is set to an environment variables.	Running the system command when active/inactive has failed. Check to see if a search path is set as an environmental variable.
Error: Failed to create a mount point. The disk space may not be sufficient.	Creating a mount point has failed. Disk space may be insufficient. Check it.
Error: Timeout has occurred on active fsck. When it is not journaling file system, it may take time to run fsck if the size of data partition of hybrid disk is large. Set timeout of fsck longer by using the Builder.	fsck time-out has occurred. In case it is not the journaling file system, running fsck may take time when the data partition of the hybrid disk is large.  Set the longer time for the fsck time-out using the Builder.
Error: Timeout occurs at activation mount. Set mount timeout longer	Time-out has occurred at active mounting. Set the mounting time-out longer by using the Builder.
Error: Timeout occurs at deactivation mount. Set unmount timeout longer.	Time-out has occurred at inactive unmounting of the file system. Set the mount time-out period longer by using the Builder.
Error: fsck failed. Check if file system type of data partition does not match configuration file, fsck option is incorrect or partition is incorrect.	Running fsck has failed. Check to see if the file system type of the data partition matches to the configuration file, <code>fsck</code> option is valid, and partition is not destroyed.
Error: Failed to mount when active. The file system type of the data partition does not match the settings of the configuration file, or the partition may be corrupted.	Mounting during activation has failed. Check to see if the file system type of the data partition matches to the configuration file, <code>fsck</code> option is valid, and the partition is not destroyed.
Error: Failed to unmount when inactive. Check if the file system on the data partition is busy.	Unmount during deactivation has failed. Check to see if the file system on data partition is not busy.
Error: Hybrid disk resource is on process of activation. Execute after activation is completed.	The hybrid disk resource is in the process of activation. Try after activation is completed.
Error: Failed to perform forced mirror recovery or activate a single server. Check if any hardware error has occurred on the disk.	Performing forced recovery or activating a standalone server has failed. Check to see if any hardware error has occurred on the disk.
Error: Entered incorrect maximum number of request queues. Check the specifiable range.	Invalid maximum number of request queues is entered. Check the range of numbers that can be specified.
Error: Failed to set the maximum number of request queues. Reboot the local server.	Setting a maximum number of request queues has failed. Restart the local server.
Error: Failed to acquire the maximum number of request queues. Reboot the local server.	Acquiring a maximum number of request queues has failed. Restart the local server.
Hybrid disk resource was not found on local server. Cannot perform this action.	The hybrid disk resource was not defined on the local server. Cannot configure the maximum number of request que. Check the status of the mirror disk resource.
Error: Failed to get the NMP path. Check if the Mirror Agent is operating normally. Reboot the local server.	Check to see if the Mirror Agent is operating normally. Restart the local server.
Error: Failed to acquire the mirror configuration information. Check if the Mirror Agent is operating normally.	Acquiring the mirror configuration information has failed. Check to see if the Mirror Agent is operating normally.



Message	Cause/Solution
Error: Failed to acquire the hybrid disk configuration information. Reboot the local server.	Acquiring hybrid disk configuration data has failed. Restart the local server.
Error: Failed to acquire the hybrid disk configuration information of both local and remote servers. Shut down the cluster and reboot both servers	Acquiring hybrid disk configuration data of both servers has failed. Shut down the cluster and restart both servers.
Error: Failed to get the number of bits of the bitmap due to the errors occurred when acquiring the mirror difference information of the cluster partition. Shut down the cluster. If it fails again, replace the disk. For procedure to replace the disk, see the Reference Guide.	Acquiring the information of mirror differences on the cluster partition has failed. Shut down the cluster. If the error occurs again, replace the disk. For information on how to replace a disk, see Chapter 10 "The system maintenance information" in this guide.
Error: The number of the bits in the bitmap is invalid. The mirror difference information of the cluster partition is invalid. Shut down the cluster. If it fails again, replace the disk. For procedure to replace the disk, see Reference Guide.	The information of the mirror differences in the cluster partition is invalid. Shut down the cluster. If the error occurs again, replace the disk. For information on how to replace a disk, see Chapter 10 "The system maintenance information" in this guide.
Error: Failed to read the mirror difference information of the local server. Reboot the local server.	Reading the information of mirror differences on the local server has failed. Restart the local server.
Error: Failed to read the mirror difference information of the local server. Reboot the local server.	Reading the information of the mirror differences on the remote server has failed. Restart the remote server.
Error: Failed to get the bitmap information of the local server due to the errors occurred when acquiring the mirror difference information of the local server. Reboot the local server.	Acquiring the information of the mirror differences on the local server has failed. Restart the local server.
Error: Failed to read the disk space. Shut down the cluster and reboot the server	Acquiring the disk space has failed. Shut down the cluster and restart the server.
Error: Failed to acquire the disk space of the other server. Shut down the cluster and reboot both servers.	Acquiring the disk space of the remote server has failed. Shut down the cluster and restart the server.
Error: Setting of cluster partition failed. Restart local server.	Configuring the cluster partition has failed. Restart the local server.
Error: Error occurred on the settings of the hybrid disk resource. Reboot the local server.	Error occurred in the status settings of hybrid disk resource. Restart the local server.
Error: Failed to create a thread. Reboot the local server.	Creating thread has failed. Restart the local server.
Error: Internal error. Failed to create process. Reboot the local server.	Creating the process has failed. Restart the local server.
Error: Failed to acquire semaphore. Reboot the local server.	Acquiring semaphore has failed. Restart the local server.
Error: A malloc error. Failed to reserve the memory space. Reboot the local server.	Reserving memory has failed. Restart the local server.
Error: Mirror driver of the local server is not loaded. Confirm kernel version.	The mirror driver of the local server is not loaded. Check the kernel version.

Message	Cause/Solution
Error: Mirror recovery cannot be executed as NMP size of mirror recovery destination is smaller than the size of where the mirror is recovered from. Change the recovery destination and try again.	Mirror recovery cannot be performed because NMP size of recovery destination is smaller than the recovery source. Change the destination and try again.
Error: NMP size of local server is bigger, cannot active. Initial mirror configuration is not completed. Execute mirror recovery from server of smaller NMP size to that of larger one.	Initial mirror configuration is not completed. Perform forced mirror recovery from the server whose NMP size is smaller to the larger one.
Local and remote recovery mode do not match. Reboot a server other than the master server to keep the same contents of configuration file among servers. Note that a failover may occur at server reboot.	The both servers are different on the recovery mode. The recovery is not performed.  Restart the servers other than master server to make the information file be the same among servers.  Note that a failover may occur at server reboot.
Failed to get remote recovery mode. Recovery will not be interrupted. Check the communication status of mirror connect.	Failed to get remote recovery mode. Recovery will not be interrupted. Check the communication status of mirror connect.
Failed to get local recovery mode. Recovery will not be interrupted. Note that a failover may occur at server reboot.	Failed to get local recovery mode. Recovery will not be interrupted. Restart the local server. Note that a failover may occur when the server is restarted.
Local or remote mirror is forced activated. Cannot to perform this action.	Hybrid disk is forcibly activated. Cannot perform the mirror recovery. Check the status of local or remote mirror.
The recovery destination of hybrid disk is activated. Cannot perform this action.	The recovery destination of mirror disk is activated. Cannot perform the mirror recovery. Check the status of the mirror disk.
Hybrid disk connection is disconnected. Cannot perform this action.	The communication status of hybrid disk connect is error. Cannot perform the mirror recovery. Check the status of the mirror disk connect.
Failed to get hybrid disk list and failed to set all NMP sync flag. Reboot the local server. Note that a failover may occur at server reboot.	The setting for synchronizing the data of all hybrid disks failed since acquiring a list of hybrid disks failed.  Reboot the local server. Note that a failover may occur at server reboot.
Failed to get hybrid disk list and failed to set all NMP sync flag to OFF. Reboot the local server. Note that a failover may occur at server reboot.	The setting for not synchronizing the data of all hybrid disks failed since acquiring a list of hybrid disks failed.  Reboot the local server. Note that a failover may occur at server reboot.
Failed to set sync flag on both servers. Shut down a cluster and reboot server.	The setting for synchronizing the data failed on both servers. Shut down the cluster and restart it.
Failed to set sync flag to OFF on both servers. Shut down a cluster and reboot server.	The setting for not synchronizing data failed on both servers. Shut down the cluster and restart it.

Message	Cause/Solution
<p>%1: Succeeded to set sync flag ON on %2 Failed to set sync flag ON on %3 Check the communication status of mirror connect</p>	<p>The setting of synchronizing data of %1 succeeded on the server %2, failed on the server %3.</p> <p>Check the running status of the server or the communication status of the mirror disk connect.</p> <p>The resource name is displayed where %1 is represented.</p> <p>The server name of which the setting succeeded is displayed where %2 is represented.</p> <p>The server name of which the setting failed is displayed where %3 is represented.</p>
<p>%1: Succeeded to set sync flag OFF on %2 Failed to set sync flag OFF on %3 Check the communication status of mirror connect</p>	<p>The setting of not synchronizing data of %1 succeeded on the server %2, failed on the server %3.</p> <p>Check the running status of the server or the communication status of the mirror disk connect.</p> <p>The resource name is displayed where %1 is represented.</p> <p>The server name of which the setting succeeded is displayed where %2 is represented.</p> <p>The server name of which the setting failed is displayed where %3 is represented.</p>
<p>Succeeded to set sync flag on remote server and failed on local server. Note that a failover may occur at server reboot.</p>	<p>The setting for synchronizing the data failed on the local server, yet succeeded on the other server. Restart the local server. Note that a failover may occur when the server is restarted.</p>
<p>Succeeded to set sync flag to OFF on remote server and failed on local server. Note that a failover may occur at server reboot.</p>	<p>The setting for not synchronizing the data failed on the local server, yet succeeded on the other server. Restart the local server. Note that a failover may occur when the server is restarted.</p>
<p>Cannot change the settings of sync status during mirror recovery. Change the settings after mirror recovery is completed.</p>	<p>The setting of synchronizing data cannot be changed during mirror recovery. Change the settings after mirror recovery is completed.</p>
<p>Hybrid disk resource was not found on local server. Cannot perform this action.</p>	<p>The hybrid disk resource is not defined on the local server. The setting of synchronizing data cannot be changed.</p>
<p>The status of the hybrid disk does not satisfy the conditions to perform this action. A probable cause: 1. Local hybrid disk is not initialized or is already force activated. 2. Local hybrid disk is not RED or remote is GREEN or remote is already activated.</p>	<p>The status of mirror is invalid. Cannot perform a forced recovery.</p>
<p>The data of hybrid disk in the local server may not be the latest. Do you still want to continue? (Y/N)</p>	<p>The data of the local server may not be the latest. Cannot check the status of hybrid disk on the other server.</p>
<p>Forced recovery has completed successfully.</p>	<p>The forced mirror recovery has successfully completed.</p>
<p>The status of hybrid disk in local server is not GREEN or is already activated. Cannot perform this action.</p>	<p>The status of mirror is invalid. Cannot disconnect a mirror.</p>
<p>Failed to set an isolate flag in the local server.</p>	<p>Cannot update the flag for mirror disconnect.</p>

Message	Cause/Solution
Isolated completed successfully.	The mirror disconnect is successfully completed.
The status of the hybrid disk does not satisfy the conditions to perform this action. A probable cause: 1. Hybrid disk is not initialized or is not RED. 2. Hybrid disk is already activated.	The status of mirror is invalid. Cannot perform the forced activation.
sync flag of %1 is successfully set to ON.	The data synchronization is set to on.  A name of the mirror resource is displayed where %1 is represented.
Failed to set sync flag of %1 on both servers. Shut down the cluster and reboot server.	Failed to set the data synchronization flag on the both servers.  A name of the mirror resource is displayed where %1 is represented.
%3: Succeeded to set sync flag ON on %1 Failed to set sync flag ON on %2 Check the communication status of mirror connect.	Failed to set the data synchronization flag on either of the servers. Check if the mirror disk connect can properly communicate.  A name of the successfully-set server is displayed where %1 is represented.  A name of the faulty-set server is displayed where %2 is represented.  A name of the mirror resource is displayed where %3 is represented.
%1: Cannot change the settings of sync status during mirror recovery. Change the settings after mirror recovery is completed.	Cannot change the data synchronization flag during mirror recovery. Change the settings after mirror recovery is completed.  A name of the mirror resource is displayed where %1 is represented.
sync flag of %1 is successfully set to OFF.	The mirror synchronization is set to off for %1.  A name of the mirror resource is displayed where %1 is represented.
%3: Succeeded to set sync flag OFF on %1 Failed to set sync flag OFF on %2 Check the communication status of mirror connect.	Failed to set the data synchronization flag on either server. Check if the mirror disk connect can normally communicate.  A name of the successfully-set server is displayed where %1 is represented.  A name of the faulty-set server is displayed where %2 is represented.  A name of the mirror resource is displayed where %3 is represented.
The specified hybrid disk is not defined on this server.	The specified hybrid disk is not defined on the local server.
Failed to acquire the path of mirror device. Check if the Mirror Agent is operating normally. Reboot the local server.	Failed to acquire the device name of the mirror disk. Check if the mirror agent is running.
The disk alias does not match the command.	The resource type of specified resource name (mirror alias name) is invalid. Use clpmdctrl for md resource, clphdctrl for hd resource.
Invalid command name.	The command name is invalid. Do not change the file name of clphdctrl command.

Message	Cause/Solution
There is an error when the server gets current priority.	An error has occurred when the server acquired the current priority.
Data synchronizing. Cannot perform this action.	This action cannot be performed on the data synchronization.
The other server is already active. Cannot perform this action.	This action cannot be performed because the resource is activated on the other server.
Cannot judge which side has the nearest data. Cannot perform this action. Reboot or execute force recovery.	Because which server has the latest data cannot be determined, this action cannot be performed. Perform the Forced Mirror Recovery.
Failed to get host name.	Acquiring the server name has failed.
This server is not current server. Cannot perform this action.	This command cannot be performed because the specified server is not the current server.
Hybrid disk internal error.	An internal error has occurred.
The current server is being forced to activated, cannot release current right.	The current priority cannot be released while the resource is activated on the server with the current priority.
The current server is changing. Cannot perform this action.	This command cannot be performed because the current priority is being shifted from the current server.
<%1>: mirror broken	The status of mirror is invalid. The target disk is in not configuring a mirror, or mirror configuring failed during the process.  A name of the mirror resource is displayed where %1 is represented.
<%1>: recovery timeout	Mirror recovery timed out. Check if the specified timeout period is appropriate, and if the disk I/O or communication delay is not occurring due to heavy loads.  A name of the mirror resource is displayed where %1 is represented.
Cannot perform this action.(Device: %1). Check if the Cluster Partition or Data Partition is OK.	Could not operate the hybrid disk resource because the hybrid disk resource is not running due to abnormality with the cluster partition or data partition.
<%1> : Succeeded to set compress flag ON.	The compression of mirror transfer data of resource %1 was switched on.  The resource name is displayed where %1 is represented.
<%1> : Succeeded to set compress flag OFF.	The compression of mirror transfer data of resource %1 was switched off.  The resource name is displayed where %1 is represented.
<%1> : Failed to set compress flag ON.	Switching on the compression of mirror transfer data of the resource %1 failed.  The mirror disk resource name is displayed where %1 is represented.
<%1> : Failed to set compress flag OFF.	Switching off the compression of mirror transfer data of the resource %1 failed.  The mirror disk resource name is displayed where %1 is represented.

Message	Cause/Solution
<%1> : Failed to set compress flag ON on %2.	Switching on the compression of mirror transfer data of the resource %1 failed on the server %2.  Check the running status of the server or the communication status of the mirror disk connection.  The mirror disk resource name is displayed where %1 is represented.  The server name is displayed where %2 is represented.
<%1> : Failed to set compress flag OFF on %2.	Switching off the compression of mirror transfer data of the resource %1 failed on the server %2.  Check the running status of the server or the communication status of the mirror disk connection.  The mirror disk resource name is displayed where %1 is represented.  The server name is displayed where %2 is represented.
<%1>: Succeeded to switch mirror disk connection. Now using mdc <priority:%2>.	The mirror disk connection was switched to the mdc of priority number %2 of the resource %1.  The mirror disk resource name is displayed where %1 is represented.  The number of the priority of the newly used mirror disk connection is displayed where %2 is represented.
Error: There is no need to switch mirror disk connection.	The specified mirror disk connection has already been used. Switching is not needed.
Error: Failed to switch mirror disk connection. The specified mirror disk connection is ERROR.	The specified mirror disk connection was not switched to because it was in the ERROR status.
Error: Failed to switch mirror disk connection. The other mirror disk connections are ERROR.	The other mirror disk connections were not switched to because they all were in the ERROR status.
Error: Failed to switch mirror disk connection.	Switching mirror disk connection failed.
Error: Specified mdc priority does not exist.	The specified priority number is invalid.  It has not been defined in the configuration information.

### List of operations to switch a current server

Current server is also switched when the following operations are performed with this command.

Hybrid disk status		Whether or not current server can be changed		Possible operation	
Server group 1	Server group 2	Server group 1	Server group 2	Server group 1	Server group 2
normal/inactive	normal/inactive	Yes	Yes	1	1
normal/ inactive	error/ inactive	Yes	Yes	1	1,3

normal/ active	error/ inactive	No	Yes	-	1,3
error/ inactive	error/ inactive	Yes	Yes	1, 2, 3	1, 2, 3
error/ inactive d	error/forcibly activated	Yes	No	2, 3	-
error/ inactive	Unknown	Yes	No	2, 3	-
pending/ inactive	pending/ inactive	Yes	Yes	1	1
pending/ inactive	Unknown	Yes	No	2	-

1	Recovering mirror (differential/entire data)
2	Forcefully recovering mirror on one server
3	Canceling access restriction (Forcible activation)
4	Disconnecting a mirror disk

**Note:**

For the procedures for switching the current server when operations like those above are performed on the WebManager, see “Mirror disk helper Changing a current server (Only for hybrid disk resource)” in Chapter 1 “Functions of the WebManager” in this guide.

## Initializing hybrid disks (`clphdinit` command)

`clphdinit`: the `clpmdinit` command initializes a hybrid disk.

### Command line:

```
clphdinit {--create | -c} normal [hybriddisk-alias]
clphdinit {--create | -c} quick [hybriddisk-alias]
clphdinit {--create | -c} force [hybriddisk-alias]
```

### Caution:

Generally you do not need to run this command when constructing or operating a cluster. You should exercise caution when you use this command because the partition used for the data will be initialized.

<b>Description</b>	This command initializes the cluster partition of a hybrid disk resource.  File systems are not created automatically to the data partition of the hybrid disk resource in this version. Create file systems in advance as necessary.	
<b>Option</b>	<pre>{--create, -c} normal</pre>	<p>Initializes a cluster partition, if necessary.</p> <p>The necessity is determined by the magic number set by EXPRESSCLUSTER on the cluster partition.</p> <p>Generally, it is not necessary to run the command with this option.</p>
	<pre>{--create, -c} quick</pre>	<p>Initializes the cluster partition, if necessary.</p> <p>Whether or not it is necessary to initialize the cluster partition is determined by the magic number set by EXPRESSCLUSTER on the cluster partition.</p> <p>Generally, it is not necessary to run the command with this option.</p>
	<pre>{--create, -c} force</pre>	<p>Forcefully initializes the cluster partition.</p> <p>This option is used when using the disk that was once used as a hybrid disk of EXPRESSCLUSTER again.</p>
<b>Parameter</b>	<i>hybriddisk-alias</i>	<p>Specifies a hybrid disk resource name.</p> <p>If this parameter is not specified, the process is performed on all hybrid disk resources.</p>
<b>Return Value</b>	0  Other than 0	Success  Failure



**Notes** You should exercise caution when you run this command because the hybrid disk will be initialized.

When there are multiple servers in one server group, execute the command on one of the servers to initialize a cluster partition.

Run this command as the root user.

Do not run other commands, until this command is returned.

When running this command, make sure that the MirrorAgent is stopped in all servers in the cluster. To check the Hybrid Agent is stopped on all servers, run the following command:

```
# /etc/init.d/clusterpro_md status
```

In a cluster with more than three nodes, if the server where the command is run is not included in a startup server of a group including hybrid disk resources, this command results in error. Do not run this command if the server is not included in a startup server of a group.

**Example of command execution** **Example 1:** When forcefully initializing the cluster partition because the disk to be used for the hybrid disk resource hd1 was once used as a hybrid disk of EXPRESSCLUSTER:

```
# clphdinit --create force hd1
mirror info will be set as default
the main handle on initializing hybrid disk <hd1>
success
initializing hybrid disk complete
```

**Error Messages**

Message	Causes/Solution
Log in as root.	Log on as the root user.
Stop the Mirror Agent.	Stop the mirror agent.
The clphdinit command is currently running. Execute after it is completed.	This command is running. Run after it is completed.
Invalid hybrid-alias. Specify a valid hybrid disk resource name.	Specify a valid hybrid disk resource name.
The mirror hybrid disk resource was not found. Set the hybrid disk resource properly.	The hybrid disk resource was not found. Set a hybrid disk resource properly.
Specified hybrid disk resource <%1> was not found. Specify a valid hybrid disk resource name.	The specified hybrid disk resource was not found. Specify a valid mirror disk resource name.
The partition does not exist. Check if the cluster partition of specified hybrid disk resource exists (<%1>).	Check to see if the specified cluster partition of the hybrid disk resource exists.
Check if the cluster partition size of specified hybrid disk resource is larger than 10MB. <%1>	Check to see if the cluster partition size of the specified hybrid disk resource is 10 MB or larger.
Internal error (open error <%1>). The cluster partition of the hybrid disk resource may not exist or the OS resource may be insufficient.	Check to see if the cluster partition of the specified hybrid disk resource exists or OS resource is sufficient.

Message	Causes/Solution
Internal error (<%1> cluster partition: unknown error). Failed to initialize the cluster partition. Check if any hardware error has occurred on the disk.	Initializing the cluster partition has failed. Check to see if there is any hardware error on the disk.
Internal error (<%1> cluster partition: %2). Check if the size of cluster partition is sufficient and if there is any hardware error on the desk.	Setting a cluster partition has failed. Check to see if the cluster partition space is sufficient and a hardware error has not occurred on the disk.
The data partition does not exist (<%1>). Check if the data partition of the specified hybrid disk resource exists. Data Partition is: %2	Check to see if the data partition of the specified hybrid disk resource exists.
Failed to initialize the cluster partition <%1>. The data partition of the specified hybrid disk resource may not exist, hardware error may have occurred on the disk, or specified file system may not be supported by OS. Check them. mirror<%2>: fstype<%3>	Initializing the data partition has failed. Check to see if the data partition of the specified hybrid disk resource exists, hardware error has not occurred on the disk and the specified file system is supported by OS.
Unknown error occurred when formatting mirror-disk<%1>. The data partition of the specified hybrid disk resource may not exist or hardware error may have occurred on the disk. Check them.	Initializing the data partition has failed. Check to see if the data partition of the specified hybrid disk resource exists and a hardware error has not occurred on the disk.
Internal error (Failed to open the data partition:<%1>). Failed to initialize the data partition. The data partition of the specified hybrid disk resource may not exist or OS resource may not be sufficient. Data Partition is: %2	Initializing the data partition has failed. Check to see if the data partition of the specified hybrid disk resource exists and OS resource is sufficient.
Internal error (data partition check error---<%1>). Failed to initialize the data partition. Check if any hardware error has occurred on the disk.	Initializing the data partition has failed. Check to see if any hardware error has not occurred on the disk.
Failed to acquire hybrid disk list information. Reboot the local server.	Acquiring a list of hybrid disk has failed. Restart the local server.
Internal error (PID write failed). Check if memory or OS resources are sufficient.	Check to see if the memory or OS resource is sufficient.
Internal error (initialization failed) Failed to read the configuration file, or failed to initialize the shared memory or semaphore. Check if the file is configured properly and reboot the local server.	Reading the configuration file, initialize the shared memory or semaphore has failed. Check to see if configuration file is correct, and restart the local server.
Internal error (termination failed) Failed to release the shared memory. Check if any system error has occurred while running the program.	Freeing up the shared memory has failed. Check to see if any system error has not occurred while running the program.
A malloc error. Failed to reserve the memory space. Reboot the local server.	Reserving memory space has failed. Restart the local server.

Message	Causes/Solution
An error has occurred when the data partition is set to writable mode. <Device:%1>. Reboot the local server.	An error occurred when the data partition was set to the writable mode. Restart the local server.
An error has occurred when the data partition is set to read-only mode. <Device:%1>. Reboot the local server.	An error occurred when the data partition was set to the read-only mode. Restart the local server.
Cluster Partition or Data Partition does not exist.	No cluster partition or data partition exists. Check if a partition is created.
Failed to upgrade the cluster partition of <%s>.	Upgrading a cluster partition failed. Check if there is an error on the disk.
Specified hybrid disk resource was not found on local server. Cannot perform this action.	The hybrid disk resource is not defined on the local server. Cannot perform initialization. Check the status of the mirror disk resource.
The disk alias does not match the command.	The resource type of the specified resource name (mirror alias name) is invalid. Use clpmdinit for md resource, clphdinit for hd resource.
Invalid command name.	The command name is invalid. Do not change the file name of clphdinit command.
Initializing hybrid disk of %1 failed. Check if the Cluster Partition or Data Partition is OK.	Failed to initialize the hybrid disk resource because the cluster partition or the data partition is abnormal.

## Outputting messages (clplogcmd command)

**clplogcmd:** the `clplogcmd` command registers the specified text with syslog and alert, reports the text by mail, or sends it as an SNMP trap.

### Command line:

```
clplogcmd -m message [--syslog] [--alert] [--mail] [--trap] [-i eventID] [-l level]
```

### Note:

Generally, it is not necessary to run this command for constructing or operating the cluster. You need to write the command in the exec resource script.

<b>Description</b>	Write this command in the exec resource script and output messages you want to send to the destination.	
<b>Options</b>	<p><code>-m <i>message</i></code> Specifies text to be produced in message. This option cannot be omitted. The maximum size of message is 511 bytes. (When syslog is specified as an output destination, the maximum size is 485 bytes.) The text exceeding the maximum size will not be shown.</p> <p>You may use alphabets, numbers, and symbols. See below (*) for notes on them.</p> <p><code>--syslog</code> Specify the output destination from syslog, alert, mail, and trap. (Multiple destinations can be specified.)</p> <p><code>--alert</code> This parameter can be omitted. The syslog and alert will be the output destinations when the parameter is omitted.</p> <p><code>--mail</code></p> <p><code>--trap</code></p> <p>For more information on output destinations, see “Directory structure of EXPRESSCLUSTER” in Chapter 10 “The system maintenance information” in this guide.</p> <p><code>-i <i>eventID</i></code> Specify event ID. The maximum value of event ID is 10000.</p> <p>This parameter can be omitted. The default value 1 is set when the parameter is omitted.</p> <p><code>-l <i>level</i></code> Select a level of alert output from ERR, WARN, or INFO. The icon on the alert view of the WebManager is determined according to the level you select here.</p> <p>This parameter can be omitted. The default value INFO is set when the parameter is omitted.</p> <p>For more information, see “Checking alerts using the WebManager” in Chapter 1 “Functions of the WebManager” in this guide.</p>	
<b>Return Value</b>	<p>0 Success</p> <p>Other than 0 Failure</p>	
<b>Notes</b>	<p>Run this command as the root user.</p> <p>When mail is specified as the output destination, you need to make the</p>	

settings to send mails by using the `mail` command.

### Example of command execution

**Example 1:** When specifying only message (output destinations are syslog and alert):

When the following is written in the exec resource script, text is produced in syslog and alert.

```
clplogcmd -m test1.
```

The following log is the log output in syslog:

```
Sep 1 14:00:00 server1 expresscls: <type: logcmd><event: 1> test1
```

The following is displayed in the alert view of the WebManager:

**Example 2:** When specifying message, output destination, event ID, and level (output destination is mail):

When the following is written in the exec resource script, the text is sent to the mail address set in the **Cluster Properties**. For more information on the mail address settings, see “Cluster properties Alert Service tab” in Chapter 2 “Functions of the Builder” in this guide.

```
clplogcmd -m test2 --mail -i 100 -l ERR
```

The following information is sent to the mail destination:

```
Message:test2
Type: logcmd
ID: 100
Host: server1
Date: 2004/09/01 14:00:00
```

**Example 3:** When specifying a message, output destination, event ID, and level (output destination is trap):

When the following is written in the exec resource script, the text is set to the SNMP trap destination set in **Cluster Properties** of the Builder. For more information on the SNMP trap destination settings, see “Cluster properties Alert Service tab” in Chapter 2 “Functions of the Builder” in this guide.

```
clplogcmd -m test3 --trap -i 200 -l ERR
```

The following information is sent to the SNMP trap destination:

```
Trap OID:      clusterEventError
Attached data 1: clusterEventMessage = test3
Attached data 2: clusterEventID = 200
Attached data 3: clusterEventDateTime = 2011/08/01 09:00:00
Attached data 4: clusterEventServerName = server1
Attached data 5: clusterEventModuleName = logcmd
```

### \* Notes on using symbols in text:

The symbols below must be enclosed in double quotes (“ ”):

```
# & ' ( ) ~ | ; : * < > , .
```

(For example, if you specify “#” in the message, # is produced.)

The symbols below must have a backslash \ in the beginning:

```
\ ! " & ' ( ) ~ | ; : * < > , .
```

(For example, if you specify `\\` in the message, `\` is produced.)

The symbol that must be enclosed in double quotes (“ ”) and have a backslash `\` in the beginning:

(For example, if you specify “`\`” in the message, ``` will is produced.)

- ◆ When there is a space in text, it must be placed in enclosed in double quotes (“ ”).
- ◆ The symbol `%` cannot be used in text.

## Controlling monitor resources (clpmonctrl command)

**clpmonctrl:** the `clpmonctrl` command controls the monitor resources.

### Command line:

```
clpmonctrl -s [-m resource_name ...] [-w wait_time]
clpmonctrl -r [-m resource_name ...] [-w wait_time]
clpmonctrl -c [-m resource_name ...]
clpmonctrl -v [-m resource_name ...]
clpmonctrl -e -m resource_name
clpmonctrl -n [-m resource_name]
```

### Note:

This command must be run on all servers that control monitoring because the command controls the monitor resources on a single server.

It is recommended to use the WebManager if you suspend or resume monitor resources on all the servers in a cluster.

<b>Description</b>	This command suspends and/or resumes the monitor resources on a single server, displays and/or resets the times counter of the recovery action, and enable and/or disable Dummy Failure.	
<b>Option</b>	-s	Suspends monitoring
	-r	Resumes monitoring
	-c	Resets the times counter of the recovery action.
	-v	Displays the times counter of the recovery action.
	-e	Enables the Dummy Failure. Be sure to specify a monitor resource name with the <code>-m</code> option.
	-n	Disables the Dummy Failure. When a monitor resource name is specified with the <code>-m</code> option, the function is disabled only for the resource. When the <code>-m</code> option is omitted, the function is disabled for all monitor resources.
	-m <i>resource_name ...</i>	Specifies one or more monitor resources to be controlled.  This option can be omitted. All monitor resources are controlled when the option is omitted.
	-w <i>wait_time</i>	Waits for control monitoring on a monitor resource basis (in seconds).  This option can be omitted. The default value 5 is set when the option is omitted.
<b>Return Value</b>	0	Normal termination
	1	Privilege for execution is invalid
	2	The option is invalid
	3	Initialization error

- 4 The cluster configuration data is invalid
- 5 Monitor resource is not registered.
- 6 The specified monitor resource is invalid
- 10 The cluster is not activated
- 11 The cluster daemon is suspended
- 12 Waiting for cluster synchronization
- 90 Monitoring control wait time-out
- 128 Duplicated activation
- 255 Other internal error

**Example of Monitor resource configuration command execution**

```
# clpstat -m
=== MONITOR RESOURCE STATUS ===
Cluster : cluster
 *server0 : server1
  server1 : server2

Monitor0 [ipw1 : Normal]
-----
server0 [o]:Online
server1 [o]:Online

Monitor1 [miiw1: Normal]
-----
server0 [o]:Online
server1 [o]:Online

Monitor2 [userw :Normal]
-----
server0 [o]:Online
server1 [o]:Online
=====
```

In the examples 1 below, the monitor resources of the server1 are controlled.

To control the monitor resources of the server2, run this command in the server2.



**Example 1:** When suspending all monitor resources:

```
# clpmonctrl -s

Command succeeded.

# clpstat -m
=== MONITOR RESOURCE STATUS ===
Cluster : cluster
  *server0 : server1
  server1 : server2

[Monitor0 [ipw1 :Caution] ]
-----
server0 [o]:Suspend
server1 [o]:Online

[Monitor1 [miw1:Caution] ]
-----
server0 [o]:Suspend
server1 [o]:Online

[Monitor2 [userw :Caution] ]
-----
server0 [o]:Suspend
server1 [o]:Online
=====
```

**Example 2:** When resuming all monitor resources:

```
# clpmonctrl -r

Command succeeded.

# clpstat -m
=== MONITOR RESOURCE STATUS ===
Cluster : cluster
  *server0 : server1
  server1 : server2

[Monitor0 [ipw1 :Normal] ]
-----
server0 [o]:Online
server1 [o]:Online

[Monitor1 [miw1:Normal] ]
-----
server0 [o]:Online
server1 [o]:Online

[Monitor2 [userw :Normal] ]
-----
server0 [o]:Online
server1 [o]:Online
=====
```

**Example 3:** When displaying the times counter of the recovery action of all monitor resource.

```
# clpmonctrl -v
-----
Resource           : ipw1
Script Count       : 0/0
Restart Count      : 1/1
Failover Count     : 3/3
FinalAction Count  : 0 [No Operation]
-----
Resource           : miw1
Script Count       : 0/0
Restart Count      : 0/0
Failover Count     : 1/1
FinalAction Count  : 0 [No Operation]
-----
Resource           : userw
Script Count       : 0/0
Restart Count      : 0/0
Failover Count     : 0/0
FinalAction Count  : 0 [-]
-----

Command succeeded.
```

**Example 4:** When resetting the times counter of the recovery action of all monitor resource.

```
# clpmonctrl -c
Command succeeded.

# clpmonctrl -v
-----
Resource           : ipw1
Script Count       : 0/0
Restart Count      : 0/1
Failover Count     : 0/3
FinalAction Count  : 0 [No Operation]
-----
Resource           : miw1
Script Count       : 0/0
Restart Count      : 0/0
Failover Count     : 1/1
FinalAction Count  : 0 [No Operation]
-----
Resource           : userw
Script Count       : 0/0
Restart Count      : 0/0
Failover Count     : 0/0
FinalAction Count  : 0 [-]
-----

Command succeeded.
```

**Example 5:** When suspending only the IP monitor resource (ipw1):

```
# clpmonctrl -s -m ipw1

Command succeeded.

# clpstat -m
=== MONITOR RESOURCE STATUS ===
Cluster : cluster
  *server0 : server1
  server1 : server2

[Monitor0 [ipw1 :Caution]]
-----
[server0 [o]:Suspend]
server1 [o]:Online

Monitor1 [miiw1:Normal]
-----
server0 [o]:Online
server1 [o]:Online

Monitor2 [userw :Normal]
-----
server0 [o]:Online
server1 [o]:Online
=====
```

**Example 6:** When resuming only the IP monitor resource (ipw1):

```
# clpmonctrl -r -m ipw1

Command succeeded.

# clpstat -m
=== MONITOR RESOURCE STATUS ===
Cluster : cluster
  *server0 : server1
  server1 : server2

[Monitor0 [ipw1 :Normal]]
-----
[server0 [o]:Online]
server1 [o]:Online

Monitor1 [miiw1:Normal]
-----
server0 [o]:Online
server1 [o]:Online

Monitor2 [userw :Normal]
-----
server0 [o]:Online
server1 [o]:Online
=====
```

**Example 7:** When displaying the times counter of the recovery action of IP monitor resource.

```
# clpmonctrl -v -m ipw1
-----
Resource -----: ipw1
|Script Count      : 0/0
|Restart Count     : 1/1
|Failover Count    : 3/3
|FinalAction Count : 0 [No Operation]
-----

Command succeeded.
```

**Example 8:** When resetting the times counter of the recovery action of IP monitor resource.

```
# clpmonctrl -c -m ipw1

Command succeeded.

# clpmonctrl -v -m ipw1
-----
Resource -----: ipw1
|Script Count      : 0/0
|Restart Count     : 1/1
|Failover Count    : 3/3
|FinalAction Count : 0 [No Operation]
-----

Command succeeded.
```

**Remarks**

If you suspend a monitor resource that is already suspended or resume that is already resumed, this command terminates successfully without changing the status of the monitor resource.

**Notes**

Run this command as the root user.

Check the status of monitor resource by using the status display clpstat command or WebManager.

Before you run this command, use the clpstat command or WebManager to verify that the status of monitor resources is in either “Online” or “Suspend.”

When the recovery action of monitor resource uses one of the following settings, “Final Action Count” (which is displayed in the -v option) indicates the number of times to execute a script before the final action.

- Execute Script Before Final Action: Enable
- Final action: No Operation

**Error Messages**

<b>Message</b>	<b>Causes/Solution</b>
Command succeeded.	The command ran successfully.
Log in as root.	You are not authorized to run this command. Log on as the root user.
Initialization error. Check if memory or OS resources are sufficient.	Check to see if the memory or OS resource is sufficient.
Invalid cluster configuration data. Check it by using the Builder.	The cluster configuration data is invalid. Check the cluster configuration data by using the Builder.
Monitor resource is not registered.	The monitor resource is not registered.
Specified monitor resource is not registered. Check the cluster configuration information by using the Builder.	The specified monitor resource is not registered. Check the cluster configuration data by using the Builder.
The cluster has been stopped. Check the active status of the cluster daemon by using the command such as ps command.	The cluster has been stopped. Check the activation status of the cluster daemon by using a command such as ps command.
The cluster has been suspended. The cluster daemon has been suspended. Check activation status of the cluster daemon by using a command such as the ps command.	The cluster daemon has been suspended. Check the activation status of the cluster daemon by using a command such as ps command.
Waiting for synchronization of the cluster. The cluster is waiting for synchronization. Wait for a while and try again.	Synchronization of the cluster is awaited. Try again after cluster synchronization is completed.
Monitor %1 was unregistered, ignored. The specified monitor resources %1 is not registered, but continue processing. Check the cluster configuration data by using the Builder.	There is an unregistered monitor resource in the specified monitor resources but it is ignored and the process is continued Check the cluster configuration data by using the Builder.  %1: Monitor resource name
Monitor %1 denied control permission, ignored. but continue processing.	The specified monitor resources contain the monitor resource which cannot be controlled, but it does not affect the process.  %1: Monitor resource name
This command is already run.	The command is already running. Check the running status by using a command such as ps command.
Internal error. Check if memory or OS resources are sufficient.	Check to see if the memory or OS resource is sufficient.

Monitor resource types that can be specified for the `-m` option

Type	Suspending/resuming monitoring	Resetting the times counter of the recovery action	Enabling/disabling Dummy Failure
arpw	n	y	n
bmcw	y	y	y
diskw	y	y	y
fipw	y	y	y
ipw	y	y	y
miiw	y	y	y
mtw	y	y	y
pidw	y	y	y
volmgrw	y	y	y
userw	y	y	n
vipw	n	y	n
vmw	y	y	n
ddnsw	n	y	n
mrw	y	y	n
genw	y	y	y
mdw	y	y	n
mdnw	y	y	n
hdw	y	y	n
hdnw	y	y	n
oraclew	y	y	y
oracleasw	y	y	y
osmw	y	y	y
db2w	y	y	y
psqlw	y	y	y
mysqlw	y	y	y
sybasew	y	y	y
sambaw	y	y	y
nfsw	y	y	y
httpw	y	y	y
ftpw	y	y	y
smtpw	y	y	y
pop3w	y	y	y
imap4w	y	y	y
tuxw	y	y	y
wlsw	y	y	y
wasw	y	y	y
otxw	y	y	y
jraw	y	y	y
sraw	y	y	y
psw	y	y	y

## Controlling group resources (clprsc command)

**clprsc:** the `clprsc` command controls group resources

**Command line:**

```
clprsc -s resource_name [-h hostname] [-f] [--apito timeout]
clprsc -t resource_name [-h hostname] [-f] [--apito timeout]
clprsc -n resource_name
clprsc -v resource_name
```

**Description** This command starts and stops group resources.

<b>Option</b>	-s	Starts group resources.
	-t	Stops group resources.
	-h	Requests processing to the server specified by the hostname. When this option is skipped, request for processing is made to the following servers. <ul style="list-style-type: none"> <li>• When the group is offline, the command execution server (local server).</li> <li>• When the group is online, the server where group is activated.</li> </ul>
	-f	When the group resource is online, all group resources that the specified group resource depends starts up. When the group resource is offline, all group resources that the specified group resource depends stop.
	-n	Displays the name of the server on which the group resource has been started.
	--apito timeout	Specify the interval (internal communication timeout) to wait for the group resource start or stop in seconds. A value from 1 to 9999 can be specified. If the --apito option is not specified, waiting for the group resource start or stop is performed according to the value set to the internal communication timeout of the cluster properties.
	-v	Displays the failover counter of the group resource.

<b>Return Value</b>	0	success
	Other than 0	failure

**Example** Group resource configuration

```
# clpstat
===== CLUSTER STATUS =====
Cluster : cluster
<server>
      *server1.....: Online
```

```

        lanhb1           : Normal
        lanhb2           : Normal
        pingnp1          : Normal
server2 ..... : Online
        lanhb1           : Normal
        lanhb2           : Normal
        pingnp1          : Normal
<group>
  ManagementGroup ..... : Online
    current             : server1
  ManagementIP         : Online
  failover1 ..... : Online
    current             : server1
    fip1                : Online
    md1                 : Online
    execl               : Online
  failover2 ..... : Online
    current             : server2
    fip2                : Online
    md2                 : Online
    exec2               : Online
<monitor>
  ipw1                 : Normal
  mdnw1                : Normal
  mdnw2                : Normal
  mdw1                 : Normal
  mdw2                 : Normal
=====

```

**Example 1:** When stopping the resource (fip1) of the group (failover 1)

```
# clprsc -t fip1
```

```
Command succeeded.
```

```
# clpstat
```

```
===== CLUSTER STATUS =====
```

```
<abbreviation>
```

```
<group>
```

```

  ManagementGroup ..... : Online
    current             : server1
  ManagementIP         : Online
  failover1 ..... : Online
    current             : server1

```



```

    fip1                               : Offline
    md1                                 : Online
    exec1                               : Online
    failover2.....                     : Online
    current                             : server2
    fip2                                 : Online
    md2                                 : Online
    exec2                               : Online
<abbreviation>

```

**Example 2:** When starting the resource (fip1) of the group(failover 1)

```

# clprsc -s fip1
Command succeeded.
# clpstat
===== CLUSTER STATUS =====
<Abbreviation>
<group>
    ManagementGroup.....             : Online
    current                           : server1
    ManagementIP                       : Online
    failover1.....                     : Online
    current                             : server1
    fip1                               : Online
    md1                                 : Online
    exec1                               : Online
    failover2.....                     : Online
    current                             : server2
    fip2                                 : Online
    md2                                 : Online
    exec2                               : Online
<Abbreviation>

```

**Notes**

Run this command as a user with root privileges.

Check the status of the group resources by the status display or the WebManager.

When there is an active group resource in the group, the group resources that are offline cannot be started on another server.

**Error Messages**

Message	Causes/Solution
Log in as root.	Run this command as a user with root privileges.

Message	Causes/Solution
Invalid cluster configuration data. Check it by using the Builder.	The cluster construction information is not correct. Check the cluster construction information by Builder.
Invalid option.	Specify a correct option.
Could not connect server. Check if the cluster service is active.	Check if the EXPRESSCLUSTER is activated.
Invalid server status. Check if the cluster service is active.	Check if the EXPRESSCLUSTER is activated.
Server is not active. Check if the cluster service is active.	Check if the EXPRESSCLUSTER is activated.
Invalid server name. Specify a valid server name in the cluster.	Specify a correct server name in the cluster.
Connection was lost. Check if there is a server where the cluster service is stopped in the cluster.	Check if there is any server with EXPRESSCLUSTER service stopped in the cluster,
Internal communication timeout has occurred in the cluster server. If it occurs frequently, set the longer timeout.	Timeout has occurred in internal communication in the EXPRESSCLUSTER. Set the internal communication timeout longer if this error occurs frequently.
The group resource is busy. Try again later.	Because the group resource is in the process of starting or stopping, wait for a while and try again.
An error occurred on group resource. Check the status of group resource.	Check the group resource status by using the WebManager or the <code>clpstat</code> command.
Could not start the group resource. Try it again after the other server is started, or after the Wait Synchronization time is timed out.	Wait until the other server starts or the wait time times out, and then start the group resources.
No operable group resource exists in the server.	Check there is a processable group resource on the specified server.
The group resource has already been started on the local server.	Check the group resource status by using the WebManager or <code>clpstat</code> command.
The group resource has already been started on the other server.	Check the group resource status by using the WebManager or <code>clpstat</code> command. Stop the group to start the group resources on the local server.
The group resource has already been stopped.	Check the group resource status by using the WebManager or <code>clpstat</code> command.
Failed to start group resource. Check the status of group resource.	Check the group resource status by using the WebManager or <code>clpstat</code> command.
Failed to stop resource. Check the status of group resource.	Check the group resource status by using the WebManager or <code>clpstat</code> command.
Depended resource is not offline. Check the status of resource.	Because the status of the depended group resource is not offline, the group resource cannot be stopped. Stop the depended group resource or specify the <code>-f</code> option.
Depending resource is not online. Check the status of resource.	Because the status of the depended group is not online, the group resource cannot be started. Start the depended group resource or specify the <code>-f</code> option.

Message	Causes/Solution
Invalid group resource name. Specify a valid group resource name in the cluster.	The group resource is not registered.
Server is not in a condition to start resource or any critical monitor error is detected.	Check the group resource status by using the WebManager or <code>clpstat</code> command. An error is detected in a critical monitor on the server on which an attempt to start a group resource was made.
Internal error. Check if memory or OS resources are sufficient.	Memory or OS resources may be insufficient. Check them.

## Controlling reboot count (`clpregctrl` command)

`clpregctrl`: the `clpregctrl` command controls reboot count limitation.

### Command line:

```
clpregctrl --get
clpregctrl -g
clpregctrl --clear -t type -r registry
clpregctrl -c -t type -r registry
```

### Note:

This command must be run on all servers that control the reboot count limitation because the command controls the reboot count limitation on a single server.

<b>Description</b>	This command displays and/or initializes reboot count on a single server.	
<b>Option</b>	<code>-g, --get</code>	Displays reboot count information.
	<code>-c, --clear</code>	Initializes reboot count.
	<code>-t <i>type</i></code>	Specifies the type to initialize the reboot count. The type that can be specified is <i>rc</i> or <i>rm</i> .
	<code>-r <i>registry</i></code>	Specifies the registry name. The registry name that can be specified is <i>haltcount</i> .
<b>Return Value</b>	0	Normal termination
	1	Privilege for execution is invalid
	2	Duplicated activation
	3	Option is invalid
	4	The cluster configuration data is invalid
	10 to 17	Internal error
	20 to 22	Obtaining reboot count information has failed.
	90	Allocating memory has failed.
	91	Changing the work directory as failed.

**Example of command execution**

Display of reboot count information

```
# clpregctrl -g
*****
-----
type      : rc
registry  : haltcount
comment   : halt count
kind      : int
value     : 0
default   : 0

-----
type      : rm
registry  : haltcount
comment   : halt count
kind      : int
value     : 3
default   : 0

*****

Command succeeded. (code:0)
```

The reboot count is initialized in the following examples.

Run this command on server2 when you want to control the reboot count of server2.

**Example1:** When initializing the count of reboots caused by group resource error:

```
# clpregctrl -c -t rc -r haltcount

Command succeeded. (code:0)

#
```

**Example2:** When initializing the count of reboots caused by monitor resource error:

```
# clpregctrl -c -t rm -r haltcount

Command succeeded. (code:0)

#
```

**Remarks**

For information on the reboot count limit, see “Attributes common to group resources Reboot count limit” in Chapter 4 “Group resource details” in this guide.

**Notes**

Run this command as the root user.

**Error Messages**

<b>Message</b>	<b>Causes/Solution</b>
Command succeeded.	The command ran successfully.
Log in as root.	You are not authorized to run this command. Log on as the root user.
The command is already executed. Check the execution state by using the "ps" command or some other command.	The command is already running. Check the running status by using a command such as ps command.
Invalid option.	Specify a valid option.
Internal error. Check if memory or OS resources are sufficient.	Check to see if the memory or OS resource is sufficient.

## Turning off warning light (clplamp command)

**clplamp**                      The `clplamp` command turns the warning light off.

**Command line:**

**clplamp**                      `-h hostname`

**Description**                Turns the warning light of the specified server off.  
If the reproduction of audio file is set, audio file reproduction is stopped.

**Option**                      `-h hostname`                Specify a server whose warning light you want to turn off.

**Return Value**                0                                Normal termination  
Other than 0                    Abnormal termination

**Example**                      **Example 1:** When turning off the warning light and audio alert for server1

```
# clplamp -h server1  
Command succeeded
```

**Notes**                        This command should be performed by the user with root privilege.

## Controlling CPU frequency (`clpcpufreq` command)

`clpcpufreq`            The `clpcpufreq` command controls CPU frequency.

### Command line:

```
clpcpufreq --high [-h hostname]
clpcpufreq --low [-h hostname]
clpcpufreq -i [-h hostname]
clpcpufreq -s [-h hostname]
```

**Description**        This command enables/disables power-saving mode by CPU frequency control.

<b>Option</b>	<code>--high</code>	Sets CPU frequency to highest.
	<code>--low</code>	Sets CPU frequency to lowest.
	<code>-i</code>	Switch to automatic control by cluster.
	<code>-s</code>	Displays the current CPU frequency level.
		<i>high</i> : Frequency is highest
		<i>low</i> : Frequency is lowered and it is in power-saving mode
	<code>-h</code>	Requests the server specified in <i>hostname</i> for processing.
	<i>hostname</i>	If this is omitted, it requests the local server for processing.

<b>Return Value</b>	0	Completed successfully.
	Other than 0	Terminated due to a failure.

**Example**

```
# clpcpufreq -s
performance
Command succeeded.

# clpcpufreq - high
Command succeeded.

# clpcpufreq --low -h server1
Command succeeded.

# clpcpufreq -i
Command succeeded
```

**Remark**            If the driver for CPU frequency control is not loaded, an error occurs.

If the **Use CPU Frequency Control** checkbox is not selected in the power saving settings in cluster properties, this command results in error.



- Notes** This command must be executed by a user with the root privilege.
- When you use CPU frequency control, it is required that frequency is changeable in the BIOS settings, and that the CPU supports frequency control by Windows OS power management function.

**Error Messages**

Message	Cause/Solution
Log in as root.	Log in as the root user.
This command is already run.	This command has already been run.
Invalid option.	Specify a valid option.
Invalid mode. Check if --high or --low or -i or -s option is specified.	Check if either of the --high, --low, -I or -s option is specified.
Failed to initialize the xml library. Check if memory or OS resources are sufficient.	Check to see if the memory or OS resource is sufficient.
Failed to load the configuration file. Check if memory or OS resources are sufficient.	Check to see if the memory or OS resource is sufficient.
Failed to load the all.pol file. Reinstall the RPM.	Reinstall the EXPRESSCLUSTER Server RPM.
Failed to load the cpufreq.pol file. Reinstall the RPM.	Reinstall the EXPRESSCLUSTER Server RPM.
Failed to get the install path. Reinstall the RPM.	Reinstall the EXPRESSCLUSTER Server RPM.
Failed to get the cpufreq path. Reinstall the RPM.	Reinstall the EXPRESSCLUSTER Server RPM.
Failed to initialize the apicl library. Reinstall the RPM.	Check to see if the memory or OS resource is sufficient.
Failed to change CPU frequency settings. Check the BIOS settings and the OS settings. Check if the cluster is started. Check if the setting is configured so that CPU frequency control is used.	Check the BIOS settings and the OS settings. Check if the cluster service is started. Check if the setting is configured so that CPU frequency control is used.
Failed to change CPU frequency settings. Check the BIOS settings and the OS settings. Check if the cluster is started. Check if the setting is configured so that CPU frequency control is used.	Check the BIOS settings and the OS settings. Check if the cluster service is started. Check if the setting is configured so that CPU frequency control is used.
Internal error. Check if memory or OS resources are sufficient.	Check if the memory or OS resource is sufficient.

## Controlling chassis identify lamp (`clpledctrl` command)

`clpledctrl`                      The `clpledctrl` command controls the chassis identify function.

### Command line:

```
clpledctrl -d [-h hostname] [-a] [-w timeout]
```

```
clpledctrl -i [-h hostname] [-a] [-w timeout]
```

**Description**    This command disables/enables chassis identify function.

<b>Option</b>	<code>-d</code>	Disables the chassis identify function.
	<code>-i</code>	Enables the chassis identify function.
	<code>-h <i>hostname</i></code>	Specifies the name of the server which enables/disables the chassis identify function. Specify <code>-a</code> to omit this.
	<code>-a</code>	All servers in the cluster are the targets. The <code>-a</code> option can be omitted. If so, specify <i>hostname</i> .
	<code>-w <i>timeout</i></code>	Specifies the timeout value of the command by the second.  If the <code>-w</code> option is not specified, it waits for 30 seconds.

<b>Return Value</b>	0	Completed successfully.
	Other than 0	Terminated due to a failure.

**Notes**                      This command must be executed by a user with the root privilege.

Execute this command in the server operating normally in the same cluster as the one which the target server belongs to.

If you disable the chassis identify function by this command, it is canceled when the cluster is restarted or when the target server recovers the normal status.

**Examples**                      Example 1: When disabling (i.e. turn off the lamp which is turned on) the chassis identify function in server1 (specify the command timeout as 60 seconds)

```
# clpledctrl -d server1 -w 60
```

Example 2: When disabling chassis identify in all servers in the cluster

```
# clpledctrl -d -a
```

Example 3: When enabling the chassis identify function in server1 where the function was disabled

```
# clpledctrl -i server1
```

The result of command execution is displayed as follows:  
Detail of the processing Server name: Result (Cause if failed)

#### Error messages

Message	Cause/solution
Log in as root.	Log in as the root user.
Invalid option.	The command line option is invalid. Specify the correct option.
Could not connect to the data transfer server. Check if the server has started up.	Check if the server has started up.
Could not connect to all data transfer servers. Check if the servers have started up.	Check the all servers in the cluster have started up.
Command timeout.	The cause may be heavy load on OS and so on. Check this.
Chassis identify is not setting or active at all servers.	Chassis identify is disabled or not used.
Failed to obtain the list of nodes. Specify a valid server name in the cluster.	Specify a valid server name in the cluster.
All servers are busy. Check if this command is already run.	This command may be run already. Check it.
Internal error. Check if memory or OS resource is sufficient.	Check if the memory or OS resource is sufficient.

## Processing inter-cluster linkage (`clptrnreq` command)

`clptrnreq`                    The `clptrnreq` command requests a server to execute a process.

### Command line:

```
clptrnreq -t request_code -h IP [-r resource_name] [-s script_file]
[-w timeout]
```

**Description**            The command issues the request to execute specified process to the server in another cluster.

<b>Option</b>	<p><code>-t</code> <i>request_code</i></p> <p><code>-h</code> <i>IP</i></p> <p><code>-r</code> <i>resource_name</i></p> <p><code>-s</code> <i>script_file</i></p> <p><code>-w</code> <i>timeout</i></p>	<p>Specifies the request code of the process to be executed. The following request codes can be specified:</p> <p>GRP_FAILOVER    Group failover</p> <p>EXEC_SCRIPT    Execute script</p> <p>Specifies the server to issue the request to execute the process with IP address. You can specify more than one server by separating by commas.</p> <p>When you specify group failover for request code, specify the IP addresses of all the servers in the cluster.</p> <p>Specifies the resource name which belongs to the target group for the request for process when GRP_FAILOVER is specified for request code.</p> <p>If GRP_FAILOVER is specified, <code>-r</code> cannot be omitted.</p> <p>Specifies the file name of the script to be executed (e.g. batch file or executable file) when EXEC_SCRIPT is specified for request code. The script needs to be created in the work\trnreq folder in the folder where EXPRESSCLUSTER is installed in each server specified with <code>-h</code>.</p> <p>If EXEC_SCRIPT is specified, <code>-s</code> cannot be omitted.</p> <p>Specifies the timeout value of the command by the second.</p> <p>If the <code>-w</code> option is not specified, the command waits 30 seconds.</p>
---------------	-----------------------------------------------------------------------------------------------------------------------------------------------------------------------------------------------------------------	---------------------------------------------------------------------------------------------------------------------------------------------------------------------------------------------------------------------------------------------------------------------------------------------------------------------------------------------------------------------------------------------------------------------------------------------------------------------------------------------------------------------------------------------------------------------------------------------------------------------------------------------------------------------------------------------------------------------------------------------------------------------------------------------------------------------------------------------------------------------------------------------------------------------------------------------------------------------------------------------------------------------------------------------------------------------------------------------------------------------------------------------------------------------------------------------------------------------------------------

<b>Return Value</b>	<p>0                    Completed successfully.</p> <p>Other than 0        Terminated due to a failure.</p>
---------------------	-------------------------------------------------------------------------------------------------------------

**Notes** This command must be executed by a user with the root privilege.

**Examples** Example 1: When performing a failover on the group having the exec1 resource of another cluster

```
# clptrnreq -t GRP_FAILOVER -h 10.0.0.1,10.0.0.2 -r
  exec1
```

Command succeeded.

Example 2: When executing the script1.bat script by the server with IP address 10.0.0.1

```
# clptrnreq -t EXEC_SCRIPT -h 10.0.0.1 -s script1.bat
```

Command Succeeded.

**Error messages**

Message	Cause/solution
Log in as root.	Log in as the root user.
Invalid option.	The command line option is invalid. Specify the correct option.
Could not connect to the data transfer server. Check if the server has started up.	Check if the server has started up.
Could not connect to all data transfer servers. Check if the servers have started up.	Check if all the servers in the cluster have started up.
Command timeout.	The cause may be heavy load on OS and so on. Check this.
All servers are busy. Check if this command is already run.	This command may be run already. Check it.
GRP_FAILOVER %s : Group that specified resource(%s) belongs to is offline.	Failover process is not performed because the group to which the specified resource belongs is not started.
EXEC_SCRIPT %s : Specified script(%s) does not exist.	The specified script does not exist. Check it.
EXEC_SCRIPT %s : Specified script(%s) is not executable.	The specified script could not be executed. Check that execution is permitted.
%s %s : This server is not permitted to execute clptrnreq.	The server that executed the command does not have permission. Check that the server is registered to the connection restriction IP list of WebManager.
GRP_FAILOVER %s : Specified resource(%s) does not exist.	The specified resource does not exist. Check it.
%s %s : %s failed in execute..	Failed to execute the specified action.
Internal error. Check if memory or OS resource is sufficient.	Check if the memory or OS resource is sufficient.

## Requesting processing to cluster servers (clprexec command)

**clprexec** This command requests a server to execute a process.

### Command line:

```
clprexec --failover ( [group_name] | [-r resource_name] )
                -h IP [-w timeout] [-p port_number] [-o logfile_path]

clprexec --script script_file -h IP [-p port_number] [-w timeout] [-o
                logfile_path]

clprexec --notice ( [mrw_name] | [-k category[keyword]] )
                -h IP [-p port_number] [-w timeout] [-o logfile_path]

clprexec --clear ( [mrw_name] | [-k category[keyword]] )
                -h IP [-p port_number] [-w timeout] [-o logfile_path]
```

**Description** This command is an expansion of the existing clptrnreq command and has additional functions such as issuing a processing request (error message) from the external monitor to the EXPRESSCLUSTER server.

<b>Option</b>	<b>--failover</b>	Requests group failover. Specify a group name for <i>group_name</i> . When not specifying the group name, specify the name of a resource that belongs to the group by using the <i>-r</i> option.
	<b>--script</b> <i>script_name</i>	Requests script execution. For <i>script_name</i> , specify the file name of the script to execute (such as a shell script or executable file). The script must be created in the work/rexec directory, which is in the directory where EXPRESSCLUSTER is installed, on each server specified using <i>-h</i> .
	<b>--notice</b>	Sends an error message to the EXPRESSCLUSTER server. Specify a message receive monitor resource name for <i>mrw_name</i> . When not specifying the monitor resource name, specify the category and keyword of the message receive monitor resource by using the <i>-k</i> option.
	<b>--clear</b>	Requests changing the status of the message receive monitor resource from “Abnormal” to “Normal.” Specify a message receive monitor resource name for <i>mrw_name</i> . When not specifying the monitor resource name, specify the category and keyword of the message receive monitor resource by using the <i>-k</i> option.

<code>-h IP address</code>	Specify the IP addresses of EXPRESSCLUSTER servers that receive the processing request. Up to 32 IP addresses can be specified by separating them with commas. * If this option is omitted, the processing request is issued to the local server.
<code>-r resource_name</code>	Specify the name of a resource that belongs to the target group for the processing request when the <code>--failover</code> option is specified.
<code>-k category[.keyword]</code>	For <i>category</i> , specify the category specified for the message receive monitor when the <code>--notice</code> or <code>--clear</code> option is specified. To specify the keyword of the message receive monitor resource, specify them by separating them with dot after <i>category</i> .
<code>-p port_number</code>	Specify the port number. For <i>port_number</i> , specify the data transfer port number specified for the server that receives the processing request. The default value, 29002, is used if this option is omitted.
<code>-o logfile_path</code>	For <i>logfile_path</i> , specify the file path along which the detailed log of this command is output. The file contains the log of one command execution. * If this option is not specified on a server where EXPRESSCLUSTER is not installed, the log is always output to the standard output.
<code>-w timeout</code>	Specify the command timeout time. The default, 180 seconds, is used if this option is not specified. A value from 5 to MAXINT can be specified.

<b>Return Value</b>	0	Completed successfully.
	Other than 0	Terminated due to a failure.

**Notes**

When issuing error messages by using the clprexec command, the message receive monitor resources for which an action to take in EXPRESSCLUSTER server when an error occurs is specified must be registered and started.

The command version is output to the standard output when the command is executed.

The command checks whether the character string specified for the `--script` option includes “\”, “/” or “..” because a relative path must not be specified.

The server that has the IP address specified for the `-h` option must satisfy the following conditions:

- = EXPRESSCLUSTER X3.0 or later must be installed.
- = EXPRESSCLUSTER must be running.
- = mrw must be set up and running.

**Examples**     **Example 1:** This example shows how to issue a request to fail over the group failover1 to EXPRESSCLUSTER server 1 (10.0.0.1):

```
# clprexec --failover failover1 -h 10.0.0.1 -p 29002
```

**Example 2:** This example shows how to issue a request to fail over the group to which the group resource (exec1) belongs to EXPRESSCLUSTER server 1 (10.0.0.1):

```
# clprexec --failover -r exec1 -h 10.0.0.1
```

**Example 3:** This example shows how to issue a request to execute the script (script1.sh) on EXPRESSCLUSTER server 1 (10.0.0.1):

```
# clprexec --script script1.sh -h 10.0.0.1
```

**Example 4:** This example shows how to issue an error message to EXPRESSCLUSTER server 1 (10.0.0.1):

```
*mrw1 set, category: earthquake, keyword: scale3
```

- This example shows how to specify a message receive monitor resource name:

```
# clprexec --notice mrw1 -h 10.0.0.1 -w 30 -p /tmp/clprexec/
  lprexec.log
```

- This example shows how to specify the category and keyword specified for the message receive monitor resource:

```
# clprexec --notice -k earthquake.scale3 -h 10.0.0.1 -w 30 -p
  /tmp/clprexec/clprexec.log
```

**Example 5:** This example shows how to issue a request to change the monitor status of mrw1 to EXPRESSCLUSTER server 1 (10.0.0.1):

```
*mrw1 set, category: earthquake, keyword: scale3
```

This example shows how to specify a message receive monitor resource name:

```
# clprexec --clear mrw1 -h 10.0.0.1
```

- This example shows how to specify the category and keyword specified for the message receive monitor resource:

```
# clprexec --clear -k earthquake.scale3 -h 10.0.0.1
```

### Error messages

Message	Cause/solution
rexec_ver:%s	-
%s %s : %s succeeded.	-
%s %s : %s will be executed from now.	Check the processing result on the server that received the request.
%s %s : Group Failover did not execute because Group(%s) is offline.	-
%s %s : Group migration did not execute because Group(%s) is offline.	-
Invalid option.	Check the command argument.
Could not connect to the data transfer servers. Check if the servers have started up.	Check whether the specified IP address is correct and whether the server that has the IP address is running.
Command timeout.	Check whether the processing is complete on the server that has the specified IP address.



Requesting processing to cluster servers (clprexec command)

Message	Cause/solution
All servers are busy.Check if this command is already run.	This command might already be running. Check whether this is so.
%s %s : This server is not permitted to execute clprexec.	Check whether the IP address of the server that executes the command is registered in the list of client IP addresses that are not allowed to connect to the WebManager.
%s %s : Specified monitor resource(%s) does not exist.	Check the command argument.
%s %s : Specified resource(Category:%s, Keyword:%s) does not exist.	Check the command argument.
%s failed in execute.	Check the status of the EXPRESSCLUSTER server that received the request.



Cluster configuration updated successfully.

**Error messages**

<b>Message</b>	<b>Cause/solution</b>
Log in as root	Log in as the root user.
Invalid option.	The command line option is invalid. Specify the correct option.
Failed to download the cluster configuration data. Check if the cluster status is normal.	Downloading the cluster configuration data has been failed. Check if the cluster status is normal.
Failed to upload the cluster configuration data. Check if the cluster status is normal.	Uploading the cluster configuration data has been failed. Check if the cluster status is normal.
Invalid configuration file. Create valid cluster configuration data by using the Builder.	The cluster configuration data is invalid. Check the cluster configuration data by using the Builder.
Internal error. Check if memory or OS resources are sufficient.	Check if the memory or OS resource is sufficient.

## Controlling cluster activation synchronization wait processing (clpbwctrl command)

**clpbwctrl**                      The `clpbwctrl` command controls the cluster activation synchronization wait processing.

**Command line:**

```
clpbwctrl -c
clpbwctrl -h
```

**Description**      This command skips the cluster activation synchronization wait time that occurs if the server is started when the cluster services for all the servers in the cluster are stopped.

**Option**              `-c, --cancel`              Cancels the cluster activation synchronization wait processing.  
                          `-h, --help`                      Displays the usage.

**Return Value**      0                      Completed successfully.  
                          Other than 0              Terminated due to a failure.

**Notes**                This command must be executed by a user with root privileges.

**Examples**            This example shows how to cancel the cluster activation synchronization wait processing:  
                          # `clpbwctrl -c`  
                          Command succeeded.

### Error messages

Message	Cause/solution
Log in as root	Log in as a root user.
Invalid option.	The command option is invalid. Specify correct option.
Cluster service has already been started.	The cluster has already been started. It is not in startup synchronization waiting status.
The cluster is not waiting for synchronization.	The cluster is not in startup synchronization waiting processing. The cluster service stop or other causes are possible.
Command Timeout.	Command execution timeout.
Internal error.	Internal error occurred.

## Estimating the amount of resource usage (clpprer command)

**clpprer** Estimates the future value from the transition of the resource use amount data listed in the input file, and then outputs the estimate data to a file. Also, the result of threshold judgment on the estimate data can be confirmed.

**Command line:**

```
clpprer -i inputfile -o outputfile [-p number] [-t number [-1]]
```

**Description** Estimates the future value from the tendency of the given resource use amount data.

**Option**

- i *inputfile* Specifies the resource data for which a future value is to be obtained.
- o *outputfile* Specifies the name of the file to which the estimate result is output.
- p *number* Specifies the number of estimate data items. If omitted, 30 items of estimate data are obtained.
- t *number* Specifies the threshold to be compared with the estimate data.
- 1 Valid only when the threshold is set with the -t option. Judges the status to be an error when the data value is less than the threshold.

**Return Value**

- 0 Normal end without threshold judgment
- 1 Error occurrence
- 2 As a result of threshold judgment, the input data is determined to have exceeded the threshold.
- 3 As a result of threshold judgment, the estimate data is determined to have exceeded the threshold.
- 4 As a result of threshold judgment, the data is determined to have not exceeded the threshold.
- 5 If the number of data items to be analyzed is less than the recommended number of data items to be analyzed (120), the input data is determined to have exceeded the threshold as a result of threshold judgment.
- 6 If the number of data items to be analyzed is less than the recommended number of data items to be analyzed (120), the estimate data is determined to have exceeded the threshold as a result of threshold judgment.
- 7 If the number of data items to be analyzed is less than the recommended number of data items to be analyzed (120), the data is determined to have not exceeded the threshold as a result of threshold judgment.

**Notes**

This command can be used only when the license for the system monitor resource (System Resource Agent) is registered. (If the license is registered, you do not have to set up the system monitor resource when configuring a cluster.)

The maximum number of input data items of the resource data file specified with the `-i` option is 500. A certain number of input data items are required to estimate the amount of resource usage. However, if the number of input data items is large, it takes a considerable amount of time to perform the analysis. So, it is recommended that the number of input data items be restricted to about 120. Moreover, the maximum number of output data items that can be specified in option `-p` is 500.

If the time data for the input file is not arranged in ascending order, the estimate will not be appropriate. In the input file, therefore, set the time data arranged in ascending order.

**Input file**

The input file format is explained below. Prepare an input file which contains the resource usage data for which to obtain an estimate, in the following format.

The input file format is CSV. One piece of data is coded in the form of *date and time, numeric value*.

Moreover, the data and time format is *YYYY/MM/DD hh:mm:ss*.

## File example

```
2012/06/14 10:00:00,10.0
2012/06/14 10:01:00,10.5
2012/06/14 10:02:00,11.0
```

**Examples**

The estimation of the future value is explained using a simple example.

**When an error is detected in the input data:**

If the latest value of the input data exceeds the threshold, an error is assumed and a return value of 2 is returned. If the number of input data items is less than the recommended value (=120), a return value of 5 is returned.

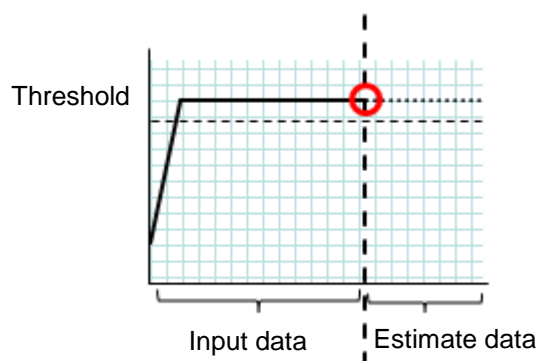

Figure: Error detection in the input data

**When an error is detected in the estimate data:**

If the estimate data exceeds the threshold, an error is assumed and a return value of 3 is returned. If the number of input data items is less than the recommended value (=120), a return value of 6 is returned.

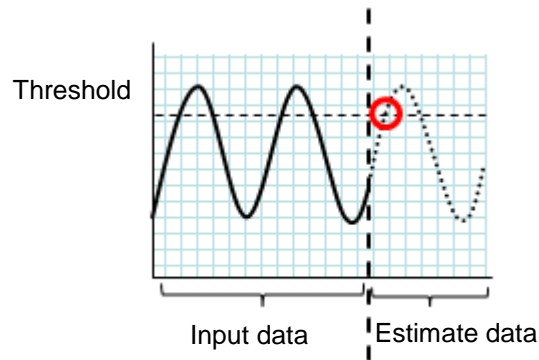

Figure: Error detection in the estimate data

**When no threshold error is detected:**

If neither the input data nor the estimate data exceeds the threshold, a return value of 4 is returned. If the number of input data items is less than the recommended value (=120), a return value of 7 is returned.

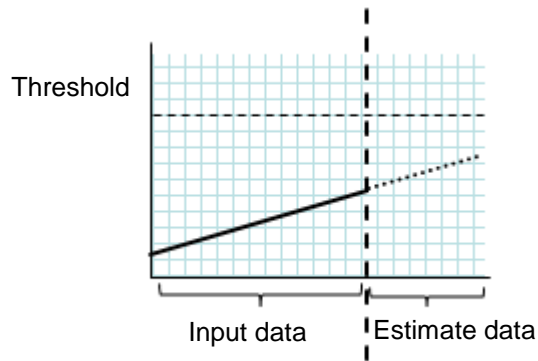

Figure: When no threshold error is detected

**When the -1 option is used:**

If the -1 option is used, an error is assumed when the data is less than the threshold.

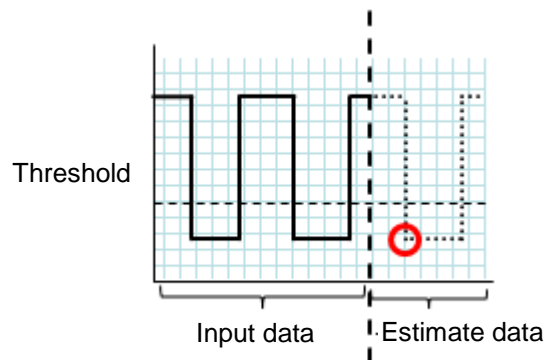

Figure: Use of the -1 option

**Examples** Prepare a file which contains data in the specified format, and then execute the `clpprer` command. The estimate result can be confirmed as the output file.

```
Input file: test.csv
2012/06/14 10:00:00,10.0
2012/06/14 10:01:00,10.5
2012/06/14 10:02:00,11.0
```

```
# clpprer -i test.csv -o result.csv
```

```
Output result: result.csv
2012/06/14 10:03:00,11.5
2012/06/14 10:04:00,12.0
2012/06/14 10:05:00,12.5
2012/06/14 10:06:00,13.0
2012/06/14 10:07:00,13.5
:
```

Also, by specifying a threshold as an option, you can confirm the threshold judgment result for the estimate at the command prompt.

```
# clpprer -i test.csv -o result.csv -t 12.5
```

Execution result

```
Detect over threshold. datetime = 2012/06/14 10:06:00,
data = 13.00, threshold = 12.5
```

**Error messages**

Message	Causes/Solution
Normal state.	As a result of threshold judgment, no data exceeding the threshold is detected.
Detect over threshold. datetime = %s, data = %s, threshold = %s	As a result of threshold judgment, data exceeding the threshold is detected.
Detect under threshold. datetime = %s, data = %s, threshold = %s	As a result of threshold judgment with the <code>-l</code> option, data less than the threshold is detected.
License is nothing.	The license for the valid System Resource Agent is not registered. Check to see the license.
Inputfile is none.	The specified input data file does not exist.
Inputfile length error.	The path for the specified input data file is too long. Specify no more than 1023 bytes.
Output directory does not exist.	The directory specified with the output file does not exist. Check whether the specified directory exists.
Outputfile length error.	The path for the specified output file is too long. Specify no more than 1023 bytes.



Message	Causes/Solution
Invalid number of -p.	The value specified in the <code>-p</code> option is invalid.
Invalid number of -t.	The value specified in the <code>-t</code> option is invalid.
Not analyze under threshold(not set -t) .	The <code>-t</code> option is not specified. When using the <code>-I</code> option, also specify the <code>-t</code> option.
File open error [%s]. errno = %s	The file failed to open. The amount of memory or OS resources may be insufficient. Check for any insufficiency.
Inputfile is invalid. cols = %s	The number of input data items is not correct. Set the number of input data items to 2 or more.
Inputfile is invalid. rows = %s	The input data format is incorrect. One line needs to be divided into two rows.
Invalid date format. [expected YYYY/MM/DD HH:MM:SS]	The date of the input data is not of the correct format. Check to see the data.
Invalid date format. Not sorted in ascending order.	Input data is not arranged in ascending order of date and time. Check the data.
File read error.	An invalid value is set in the input data. Check the data.
Too large number of data [%s]. Max number of data is %s.	The number of input data items exceeds the maximum value (500). Reduce the number of data items.
Input number of data is smaller than recommendable number.	The number of input data items is less than the recommended number of data items to be analyzed (120). * Data is analyzed even if the recommended number of data items to be analyzed is small.
Internal error.	An internal error has occurred.

## Checking the process health (`clphealthchk` command)

`clphealthchk` Checks the process health.

### Command line.

```
clphealthchk [ -t pm | -t rc | -t rm | -t nm | -h ]
```

---

**Note:** This command must be run on the server whose process health is to be checked because this command checks the process health of a single server.

---

**Description** This command checks the process health of a single server.

<b>Option</b>	None	Checks the health of all of pm, rc, rm, and nm.
	-t pm	Checks the health of pm.
	-t rc	Checks the health of rc.
	-t rm	Checks the health of rm.
	-t nm	Checks the health of nm.
	-h	Displays the usage.

<b>Return Value</b>	0	Normal termination
	1	Privilege for execution is invalid
	2	Duplicated activation
	3	Initialization error
	4	The option is invalid
	10	The process stall monitoring function has not been enabled.
	11	The cluster is not activated (waiting for the cluster to start or the cluster has been stopped.)
	12	The cluster daemon is suspended
		There is a process whose health information has not been updated within a certain period.
	100	If the -t option is specified, the health information of the specified process is not updated within a certain period.
	255	Other internal error

**Examples** **Example 1:** When the processes are healthy  

```
# clphealthchk
```

```
pm OK
rc OK
rm OK
nm OK
```

**Example 2:** When clprc is stalled

```
# clphealthchk
```

```
pm OK
rc NG
rm OK
nm OK
```

```
# clphealthchk -t rc
```

```
rc NG
```

**Example 3:** When the cluster has been stopped

```
# clphealthchk
```

```
The cluster has been stopped
```

**Remarks** If the cluster has been stopped or suspended, the process is also stopped.

**Notes** Run this command as the root user.

### Error Messages

Message	Cause/Solution
Log in as root.	You are not authorized to run this command. Log on as the root user.
Initialization error. Check if memory or OS resources are sufficient.	Check to see if the memory or OS resource is sufficient.
Invalid option.	Specify a valid option.
The function of process stall monitor is disabled.	The process stall monitoring function has not been enabled.
The cluster has been stopped.	The cluster has been stopped.
The cluster has been suspended.	The cluster has been suspended.
This command is already run.	The command has already been started. Check the running status by using a command such as ps command.
Internal error. Check if memory or OS resources are sufficient.	Check to see if the memory or OS resource is sufficient.



## Section II Resource details

This section provides detailed information on the resources that constitute a cluster.

Chapter 4	Group resource details
Chapter 5	Monitor resource details
Chapter 6	Heartbeat resources details
Chapter 7	Network partition resolution resources details
Chapter 8	Information on other settings
Chapter 9	Linkage with Server Management Infrastructure



# Chapter 4 Group resource details

This chapter provides information on group resources that constitute a failover group. For overview of group resources, see Chapter 2, “Configuring a cluster system” in the *Installation and Configuration Guide*.

This chapter covers:

- Group resources and supported EXPRESSCLUSTER versions ..... 564
- Attributes common to group resources ..... 566
- Displaying and changing the settings of group properties ..... 591
- Displaying and changing the settings of group resources ..... 605
- Understanding server groups ..... 620
- Displaying and changing the settings of server groups ..... 621
- Understanding EXEC resources ..... 624
- Understanding disk resource ..... 660
- Understanding floating IP resource ..... 674
- Understanding virtual IP resources ..... 688
- Understanding mirror disk resources ..... 706
- Understanding hybrid disk resources ..... 747
- Understanding NAS resource ..... 763
- Understanding volume manager resources ..... 771
- Understanding VM resources ..... 783
- Understanding Dynamic DNS resources ..... 795
- Understanding AWS elastic ip resources ..... 802
- Understanding AWS virtual ip resources ..... 807
- Understanding Azure probe port resources ..... 813

## Group resources and supported EXPRESSCLUSTER versions

The following is the number of group resources that can be registered with a group:

Version	Number of group resources (per group)
3.0.0-1 to 3.0.4-1	128
3.1.0-1 or later	256
3.2.0-1 or later	256

Currently supported group resources are:

Group resource name	Abbreviation	Functional overview	Supported version
Exec resource	exec	See “Understanding EXEC resources.” (Page 624)	3.0.0-1 or later
Disk resource	disk	See “Understanding disk resource.” (Page 660)	3.0.0-1 or later
Floating IP resource	fip	See “Understanding floating IP resource.” (Page 674)	3.0.0-1 or later
Virtual IP resource	vip	See “Understanding virtual IP resources” (Page 688)	3.0.0-1 or later
Mirror disk resource	md	See “Understanding mirror disk resources.” (Page 706)	3.0.0-1 or later
Hybrid disk resource	hd	See “Understanding hybrid disk resources” (Page 747)	3.0.0-1 or later
NAS resource	nas	See “Understanding NAS resource.” (Page 763)	3.0.0-1 or later
Volume manager resource	volmgr	See “Understanding volume manager resources.” (Page 771)	3.0.0-1 or later
VM resource	vm	See “Understanding VM resources.” (Page 783)	3.0.0-1 or later
Dynamic DNS resource	ddns	See “Understanding Dynamic DNS resources.” (Page 795)	3.0.0-1 or later
AWS elastic ip resource	awseip	See “Understanding AWS elastic ip resources” (Page802)	3.3.0-1 or later
AWS virtual ip resource	awsvip	See “Understanding AWS virtual ip resources” (Page807)	3.3.0-1 or later
Azure probe port resource	azurepp	See “Understanding Azure probe port resources” (Page813)	3.3.0-1 or later



The group resources that currently support dynamic resource addition are as follows:

<b>Group resource name</b>	<b>Abbreviation</b>	<b>Functional overview</b>	<b>Supported version</b>
Exec resource	exec	See "Understanding EXEC resources." (Page 624)	3.2.1-1 or later
Disk resource	disk	See "Understanding disk resource." (Page 660)	3.2.1-1 or later
Floating IP resource	fip	See "Understanding floating IP resource." (Page 674)	3.2.1-1 or later
Virtual IP resource	vip	See "Understanding virtual IP resources" (Page 688)	3.2.1-1 or later
Volume manager resource	volmgr	See "Understanding volume manager resources." (Page 771)	3.2.1-1 or later

## Attributes common to group resources

A group is a failover unit. Rules regarding the failover operations (failover policies) can be specified for a group.

### Understanding the group type

The following two types of groups exist: virtual machine groups and failover groups.

- **Virtual machine groups**

Failovers (migration) are performed on a virtual machine basis. The following resources can be registered with this group: virtual machine resource, mirror disk resource, disk resource, hybrid disk resource, EXEC resource, NAS resource, and volume manager resource. A virtual machine group automatically follows even when the virtual machine is moved to a different server by a means other than EXPRESSCLUSTER.

- **Failover groups**

Resources necessary to continue operations are grouped and failovers are performed on an operation basis. Up to 256 group resources can be registered with each group. However, no VM resource can be registered.

### Understanding the group properties

The following properties can be specified for each group:

- **Servers that can run the Group**

Select a server that can run the group from the servers in the cluster.

Specify the order of servers that can run the group and the priority according to which the group is started.

- **Startup Attribute**

Specify automatic or manual startup as the group startup attribute.

For automatic startup, the group is automatically started on the server that can run the group and has the highest priority when the cluster is started.

For manual startup, the group is not started when the server is started. Manually start the group by using the WebManager or clpgrp command after the server is started. For details about the WebManager, see Chapter 1, "Functions of the WebManager" in this guide. For details about the clpgrp command, see "Operating groups (clpgrp command)" in Chapter 3, "EXPRESSCLUSTER command reference" in this guide.

- **Failover Exclusive Attribute:**

Specify the exclusive group attribute during a failover. However, this attribute cannot be specified under the following conditions:

If **Virtual machine group** is specified as the group type

When failover attribute is one of **Fail over dynamically**, **Prioritize failover policy in the server group** or **Enable only manual failover among the server groups**.

The following failover exclusive attributes exist:

### **No exclusion**

Exclusion is not performed during a failover. The usable failover destination server that has the highest priority is used for a failover.

### **Normal exclusion**

Exclusion is performed during a failover. The usable failover destination server that has not run another normal exclusion group and has the highest priority is used for a failover.

However, exclusion is not performed if other normal exclusion groups have already been started on all the usable failover destination servers. The usable failover destination server that has the highest priority is used for a failover.

### **Complete exclusion**

Exclusion is performed during a failover. The usable failover destination server that has not run another complete exclusion group and has the highest priority is used for a failover.

However, a failover is not performed if other complete exclusion groups have already been started on all the usable failover destination servers.

---

#### **Note:**

Exclusion is not performed between normal exclusion groups and complete exclusion groups. Normal exclusion performs exclusion among normal exclusion groups while complete exclusion performs exclusion among complete exclusion groups. In either case, this action does not apply to groups for which exclusion is not specified.

---

- **Failover attribute**

The failover attribute can be used to specify the failover mode. The following failover attributes can be specified.

#### **Automatic failover**

A heartbeat timeout or error detection by a group or monitor resource triggers an automatic failover.

For an automatic failover, the following options can be specified.

- Use the startup server settings  
The failover destination is determined according to the priority of the servers that can run the group.
- Fail over dynamically  
The failover destination is determined by considering the statuses of each server's monitor resource or failover group, and then a failover is performed.

The failover destination is determined in the following way.

Determination factor	Condition		Result
Status of exclusion target monitor resource	Error (all servers)		When there is no failover destination, proceed to the processing for determining a forced failover judgment .
	Normal (single server)		A normal server is used as the failover destination.
	Normal (multiple servers)		Proceed to the process that compares error levels.
Perform a forced failover	Set		Proceed to the process that ignores the status of the exclusion target monitor resource and which compares error levels for all the activated servers.
	Not set		Failover is not performed.
Number of servers with the lowest error level	1		The server that has the lowest error level is used as the failover destination.
	Two or more		The operation levels are compared for those servers that have the lowest error level.
Prioritize failover policy in the server group	Set	Within the same server group as the failover source, there is a server that can perform failover.	The server in the same server group is used as the failover destination.
		Within the same server group as the failover source, there is no server that can perform failover.	Proceed to the smart failover judgment process.
	Not set		Proceed to the smart failover judgment process.

Determination factor	Condition		Result
Perform a smart failover	Set	The number of servers recommended as the failover destination is 1.	The server recommended by the smart failover is used as the failover destination.
		The number of servers recommended as the failover destination is 2 or more.	Proceed to the running level judgment process.
	Not set		Proceed to the running level judgment process.
Number of servers with the lowest running level	1		The server with the lowest running level is used as the failover destination.
	Two or more		Of the activated servers, the server with the highest priority is used as the failover destination.

**Note:****Critical monitor resource**

Exclude the server that detected an error in a monitor resource from the failover destination.

For version 3.1.0-1 and later, the following monitor resources are initially registered as critical monitor resource.

- IP monitor resource
- NIC Link Up/Down monitor resource

Version 3.1.5-1 and later can set the exclusive list with the Builder.

**Error level**

Number of monitor resources that detected errors

**Smart failover**

A function that assigns the server with the smallest load as the failover destination, based on the system resource information collected by the System Resource Agent. To enable this function, a System Resource Agent license must be registered on all the servers set as the failover destination and the system monitor resources must be set as the monitor resource. For detail about the system monitor resources, see "Understanding system monitor resources" in Chapter 5, "Monitor resource details" in this guide.

In the 3.1.0-1 internal version, the system load is calculated from the following values:

- CPU usage
- Memory usage

---

### Running level

Number of started failover groups or number of failover groups that are being started, excluding management groups

---

- **Prioritize failover policy in the server group**  
If a server in the same server group can be used as the failover destination, this server is preferably used. The server that can run the failover group and has the highest priority among the running servers is used as the failover destination.  
If no server in the same server group can be used as the failover destination, a server in another server group is used as the failover destination.
- **Allow only a manual failover between server groups**  
This can be selected only when the above **Prioritize failover policy in the server group** is set.  
An automatic failover is performed only if a server within the same server group is the destination.  
If no servers in the same server group can be used as the failover destination, failing over to a server in another server group is not automatically performed.  
To move the group to a server in another server group, use the WebManager or clpgrp command.

### Manual failover

A failover is not automatically performed when a heartbeat timeout occurs. Manually start a failover by using the WebManager or clpgrp command. However, even when manual failover is specified, an automatic failover is performed if a group resource or monitor resource detects an error.

---

### Note:

If **Execute Failover to outside the Server Group** is set in message receive monitor resource setting, dynamic failover setting and failover setting between server groups will be invalid. A failover is applied to the server that is in a server group other than the server group to which the failover source server belongs and which has the highest priority.

---

- **Failback attribute**

Specify automatic or manual failback. However, This cannot be specified when the following conditions match.

- Mirror disk resource or hybrid disk resource is set to fail over group.
- Failover attribute is **Fail over dynamically**.

For automatic failback, an automatic failback is performed when the server that has the highest priority is started after a failover.

For manual failback, no failback occurs even when the server is started.

## Understanding failover policy

A failover policy is a priority that determines a server to be the failover destination from multiple servers. When you configure the failover policy, avoid making certain servers heavily loaded at a failover.

The following describes how servers behave differently depending on failover policies when a failover occurs using example of the server list that can fail over and failover priority in the list.

<Symbols and meaning>

Server status	Description
O	Normal (properly working as a cluster)
X	Stopped (cluster is stopped)

3-node configuration:

Group	Priority order of servers		
	1 <sup>st</sup> priority server	2 <sup>nd</sup> priority server	3 <sup>rd</sup> priority server
A	server1	server3	server2
B	server2	server3	server1

2-node configuration:

Group	Priority order of servers	
	1 <sup>st</sup> priority server	2 <sup>nd</sup> priority server
A	server1	server2
B	server2	server1

It is assumed that the group startup attributes are set to auto startup and the failback attributes are set to manual failback for both Group A and B.

- ◆ If groups of different failover exclusive attributes co-exist in a cluster, they do not interfere with each other. For example, a group of full exclusive attributes may start on a server where a group of non-exclusive attributes is active, and vice versa.
- ◆ For groups whose failover exclusive attributes are normal or full, the server which they start up or fail over is determined by the failover priority to the server. If a group has two or more servers of the same failover priority, it is determined by the alphabetical order of the group name.

**When the failover exclusive attribute of Group A and B is set to Off:**

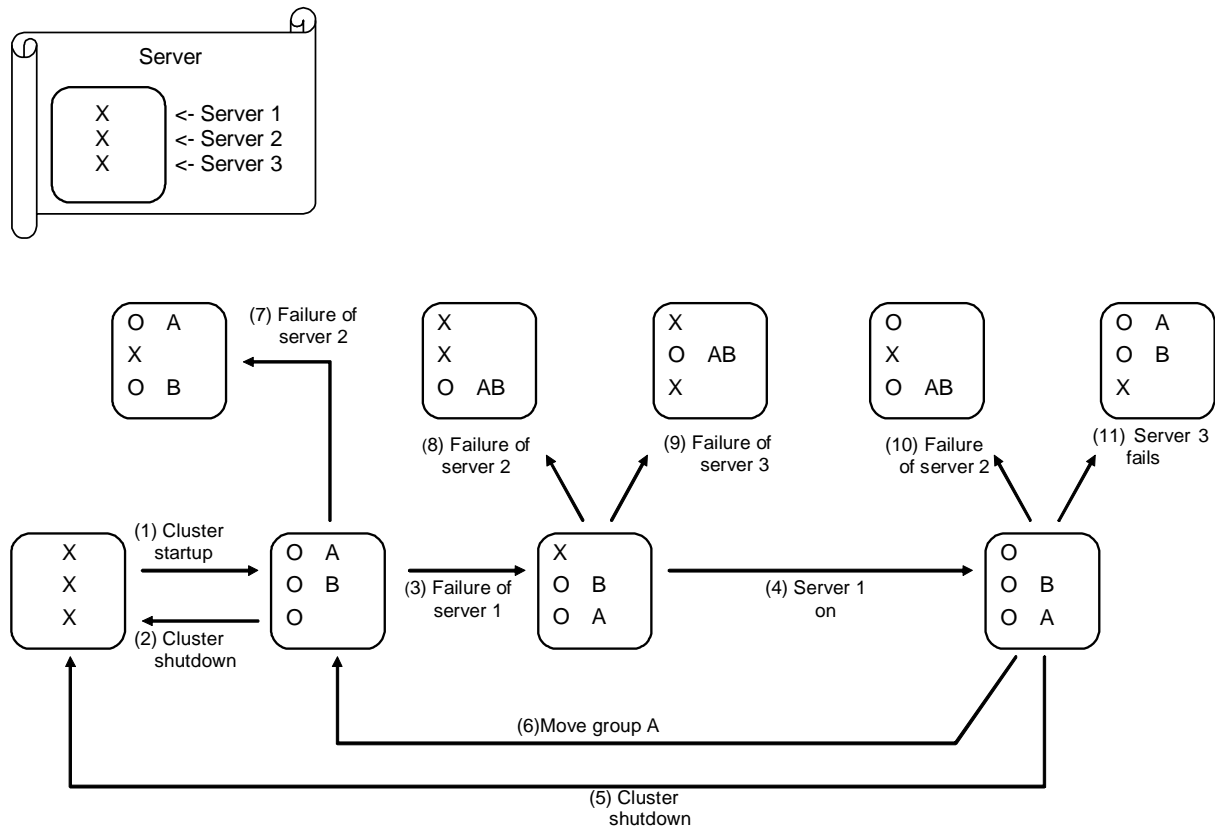

1. Cluster startup
2. Cluster shutdown
3. Failure of server1      Fails over to the next priority server.
4. Server1 power on
5. Cluster shutdown
6. Move group A
7. Failure of server2:      Fails over to the next priority server.
8. Failure of server2:      Fails over to the next priority server.
9. Failure of server3:      Fails over to the next priority server.
10. Failure of server2:      Fails over to the next priority server.
11. Failure of server3:      Fails over to the next priority server.



**When the failover exclusive attribute for Group A and B is set to Normal:**

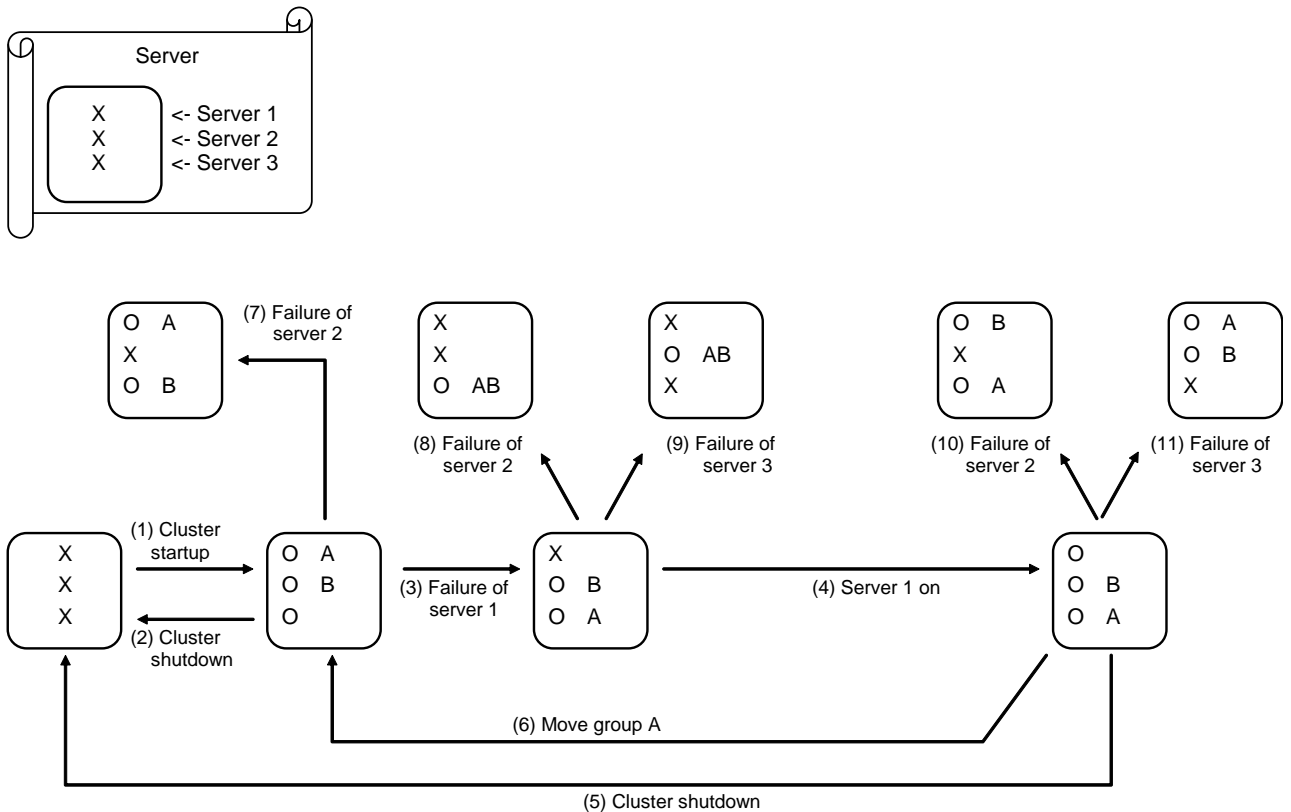

1. Cluster startup
2. Cluster shutdown
3. Failure of server1: Fails over to a server where no normal exclusive group is active.
4. Server1 power on
5. Cluster shutdown
6. Move groupA
7. Failure of server2: Fails over to a server where a normal exclusive group is not active.
8. Failure of server2: There is no server where a normal exclusive group is not active, but failover to the server because there is a server that can be started.
9. Failure of server3: There is no server where a normal exclusive group is not active, but failover to the server because there is a server that can be started.
10. Failure of server2: Fails over to a server where a normal exclusive group is not active.
11. Failure of server3: Fails over to a server where a normal exclusive group is not active.

**When the failover exclusive attribute for Group A and B is set to Absolute:**

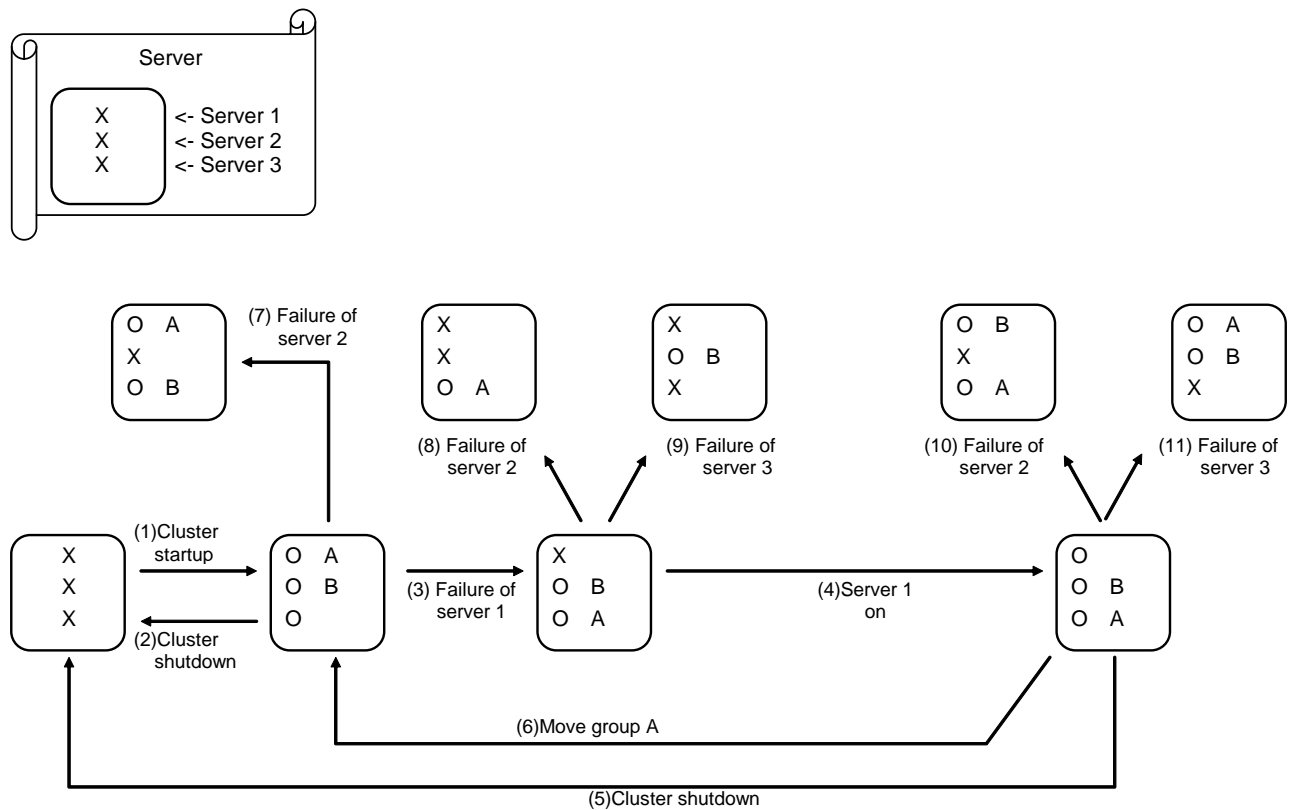

1. Cluster startup
2. Cluster shutdown
3. Failure of server1: Fails over to the next priority server.
4. server1 power on
5. Cluster shutdown
6. Move groupA
7. Failure of server2: Fails over to the next priority server.
8. Failure of server2: Does not failover (GroupB stops).
9. Failure of server3: Does not failover (GroupA stops).
10. Failure of server2: Fails over to the server where no full exclusive group is active.
11. Failure of server3: Fails over to the server where no full exclusive group is active.

**For Replicator (two-server configuration)  
When the failover exclusive attribute for Group A and B is set to Off:**

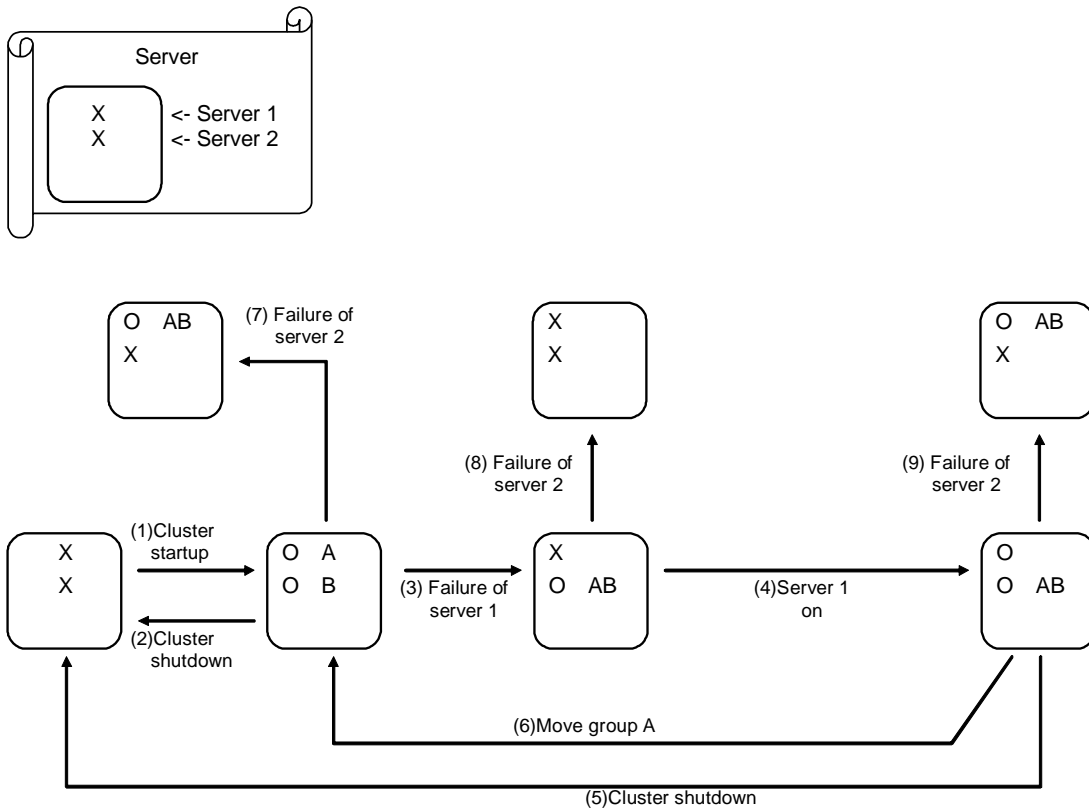

1. Cluster startup
2. Cluster shutdown
3. Failure of server1: Fails over to the standby server of GroupA.
4. Server1 power on
5. Cluster shutdown
6. Move groupA
7. Failure of server2: Fails over to the standby server of GroupB.
8. Failure of server2
9. Failure of server3: Fails over to the standby server.

## Operations at detection of activation and inactivation errors

When an activation or deactivation error is detected, the following operations are performed:

- ◆ When an error in activation of group resources is detected:
  - When an error in activation of group resources is detected, activation is retried.
  - When activation retries fail as many times as the number set to **Retry Count at Activation Failure**, a failover takes place.
  - If the failover fails as many times as the number set to **Failover Threshold**, the final action is performed.
  
- ◆ When an error in deactivation of group resources is detected:
  - When an error in deactivation of group resources is detected, deactivation is retried.
  - When deactivation retries fail as many times as the number set to **Retry Count at Deactivation Failure**, the final action is performed.

---

### Note:

Activation retries and failovers are counted on a server basis. The Retry Count at Activation Failure and Failover Threshold are maximum activation retry count and failover count on a server basis respectively.

The activation retry count and failover count are reset in a server where the group activation is successful.

Note that a failed recovery action is also counted as one for the activation retry count or failover count.

---

The following describes how an error in activation of a group resource is detected:

When the following settings are made:  
 Retry Count at Activation Failure 3 times  
 Failover Threshold 1 time  
 Final Action Stop Group

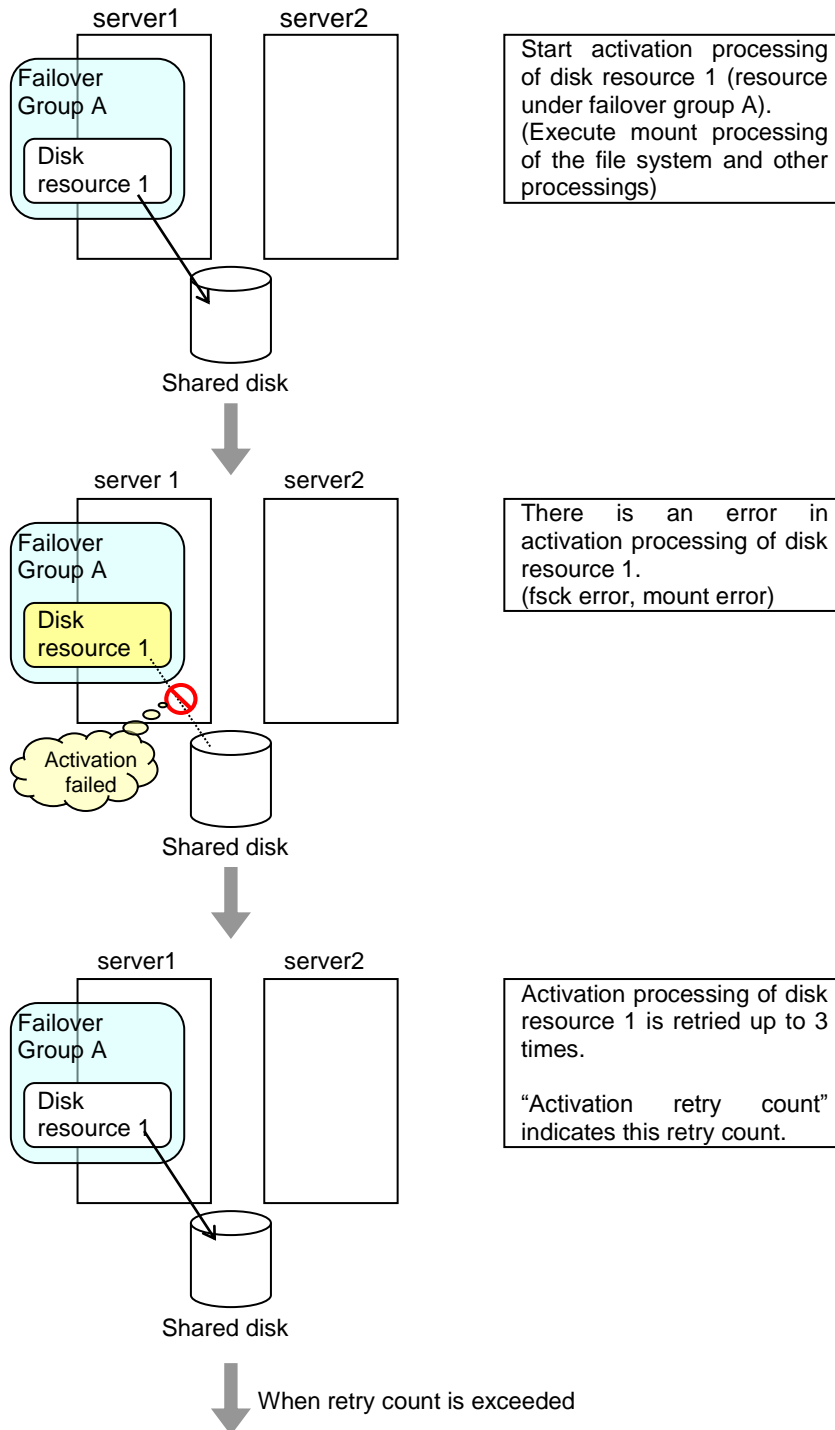

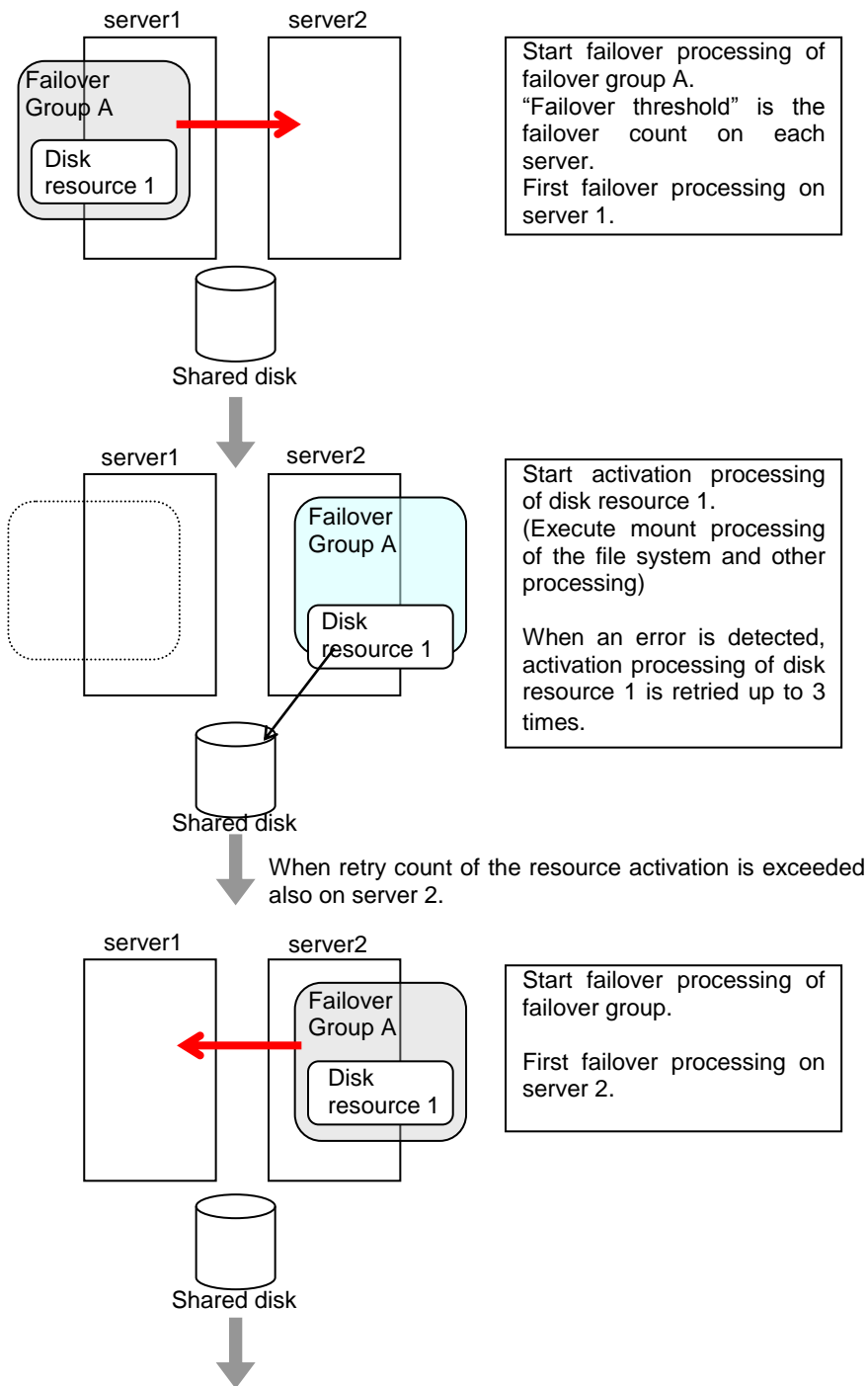

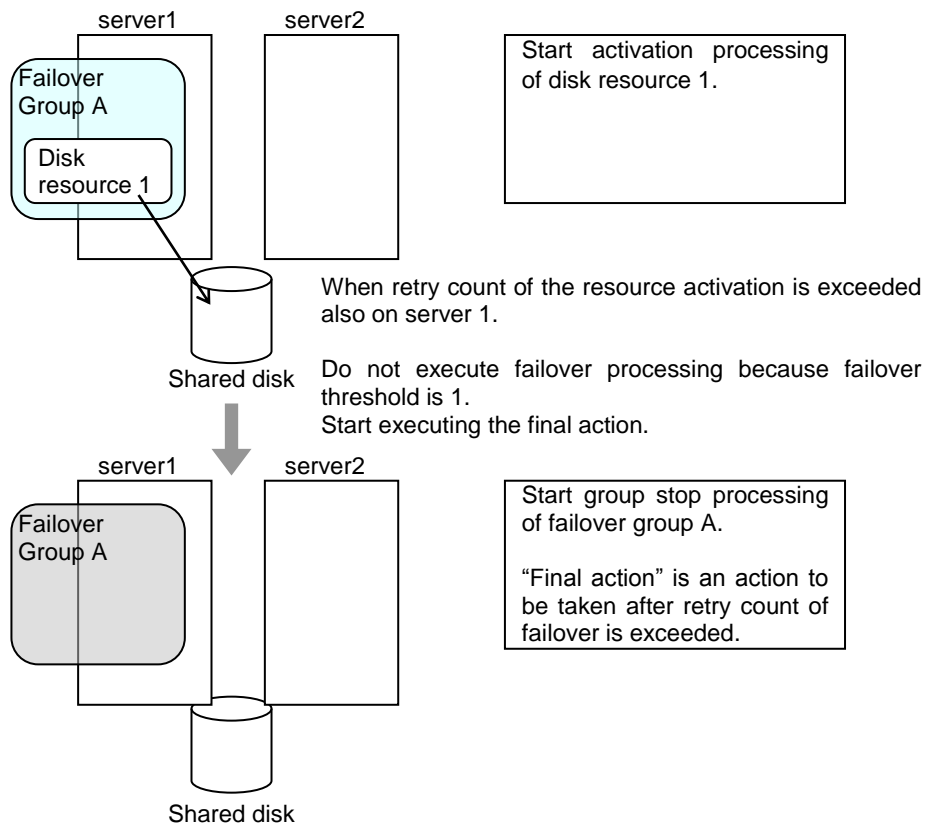

## Script before final action

When a group resource activation error is detected, a script before final action can be executed before the last action during detection of a deactivation error.

### Environment variables used with a script before final action

When executing a script, EXPRESSCLUSTER sets information such as the state in which it is executed (when an activation error occurs, when a deactivation error occurs) in the environment variables.

In the script, processing that is appropriate for the system operation can be described using the environment variables listed below as branch conditions.

Environment variable	Value	Description
CLP_TIMING ...Execution timing	START	Executes a script before final action in the event of a group resource activation error.
	STOP	Executes a script before final action in the event of a group resource deactivation error.
CLP_GROUPNAME ...Group name	Group name	Indicates the name of the group containing the group resource in which an error that causes the script before final action to be executed is detected.
CLP_RESOURCENAME ...Group resource name	Group resource name	Indicates the name of the group resource in which an error that causes the script before final action to be executed is detected.



**Flow used to describe a script before final action**

The following explains the environment variables in the previous topic and an actual script, associating them with each other.

**Example of a script before final action in the event of an activation error**

```
#!/bin/sh
# *****
# *           preactaction.sh           *
# *****

ulimit -s unlimited

echo "START"

if [ "$CLP_TIMING" = "START" ]
then

    Processing overview:
    Recovery
    Execution timing for performing this processing:
    Before final action in the event of an activation error

else
    echo "NO_CLP"
fi

echo "EXIT"
exit 0
```

Referring to the environment variable for the script execution cause, sort the processing.

**Tips for creating a script before final action**

Note the following when creating a script:

- ◆ If the script contains a command that will take some time to execute, always leave a trace that will indicate the completion of the execution of that command. If a problem occurs, you can use this information to isolate the failure. One way of leaving such a trace is to use `clplogcmd`.
- ◆ Method of describing in a script by using `clplogcmd`  
Using `clplogcmd`, you can output messages to the alert view of WebManager or syslog of the OS. For details on the `clplogcmd` command, see “Outputting messages (`clplogcmd` command)” in Chapter 3, “EXPRESSCLUSTER command reference” in this guide.

```
(Example: Script image)
clplogcmd -m "recoverystart.."
recoverystart
clplogcmd -m "OK"
```

**Notes on script before final action**

- ◆ Stack size of the commands and application to be started from a script  
A recovery script and a script before recovery action are executed with the stack size set to 2 MB. For this reason, if the commands and applications to be started from the script require a stack size of 2 MB or greater, a stack overflow will occur.

If a stack overflow occurs, set the stack size before starting the commands and applications.

- ◆ **Condition that a script before final action is executed**  
A script before final action is executed before the final action upon detection of a group resource activation or deactivation failure. Even if **No operation (Next Resources Are Activated/Deactivated)** or **No operation (Next Resources Are Not Activated/Deactivated)** is set as the final action, a script before final action is executed. If the final action is not executed because the maximum restart count has reached the upper limit or by the function to suppress the final action when all other servers are being stopped, a script before final action is not executed.

## Reboot count limit

If the action which is accompanied by OS reboot is selected as the final action to be taken when any error in activation or deactivation is detected, you can limit the number of shutdowns or reboots caused by detection of activation or deactivation errors.

This maximum reboot count is the upper limit of reboot count of each server.

---

### Note:

The maximum reboot count is the upper limit of reboot count of a server because the number of reboots is recorded per server.

The number of reboots that are taken as a final action in detection of an error in group activation or deactivation and those by a monitor resource are recorded separately.

If the time to reset the maximum reboot count is set to zero (0), the number of reboots will not be reset. Run the `clpregctrl` command to reset this number. For details on the `clpregctrl` command, see “Controlling reboot count (`clpregctrl` command)” in Chapter 3, “EXPRESSCLUSTER command reference”.

---

The following describes the flow of operations when the limitation of reboot count is set as shown below:

As a final action, **Stop cluster daemon and reboot OS** is executed once because the maximum reboot count is set to one (1).

If group activation is successful at a reboot following the cluster shutdown, the reboot count is reset after 10 minutes because the time to reset maximum reboot count is set to 10 minutes.

Setting example

- Retry Count at Activation Failure 0 time
- Failover Threshold 0 time
- Final Action Stop cluster service and reboot OS
- Max Reboot Count 1 time
- Max Reboot Count Reset Time 10 minutes

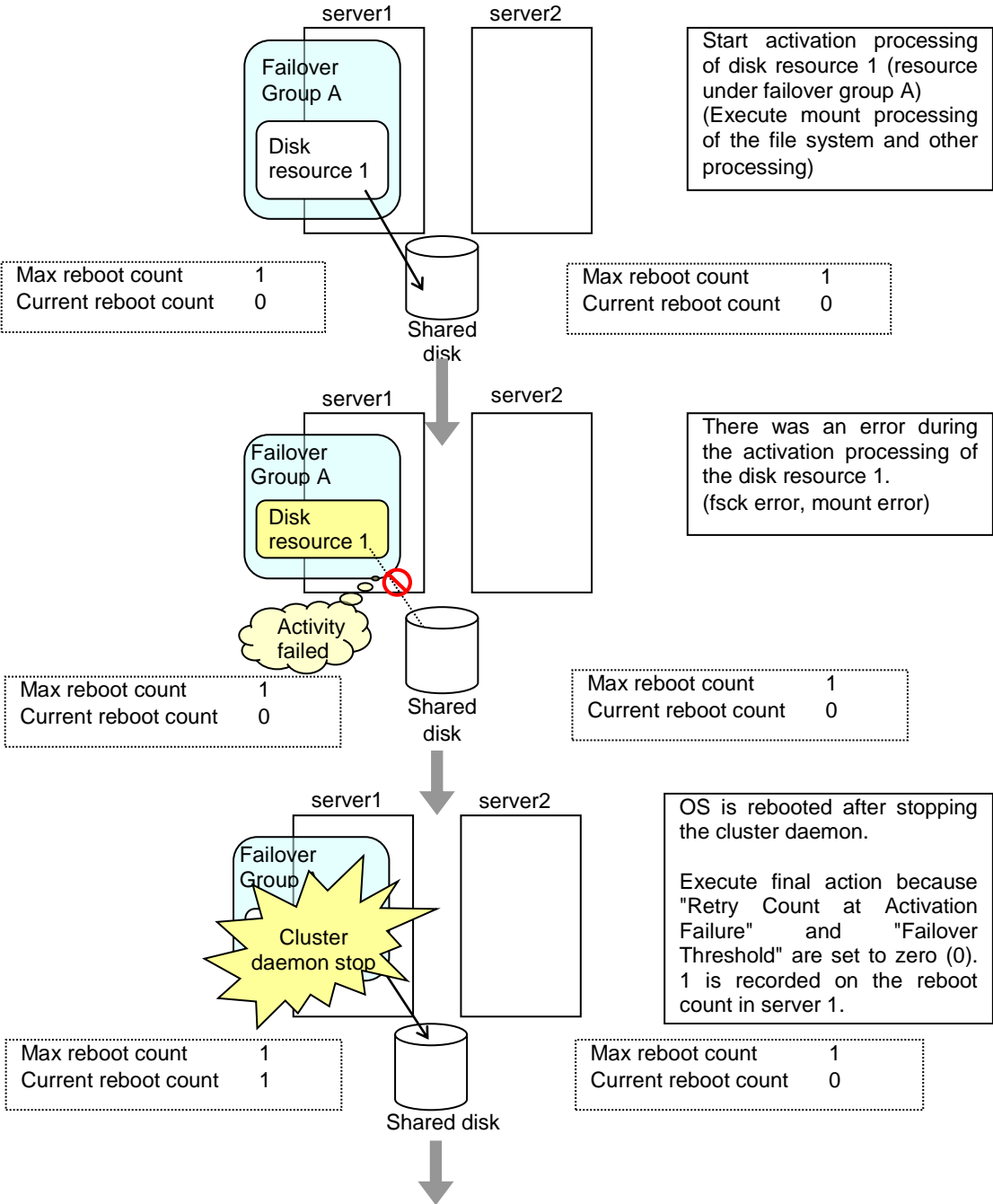

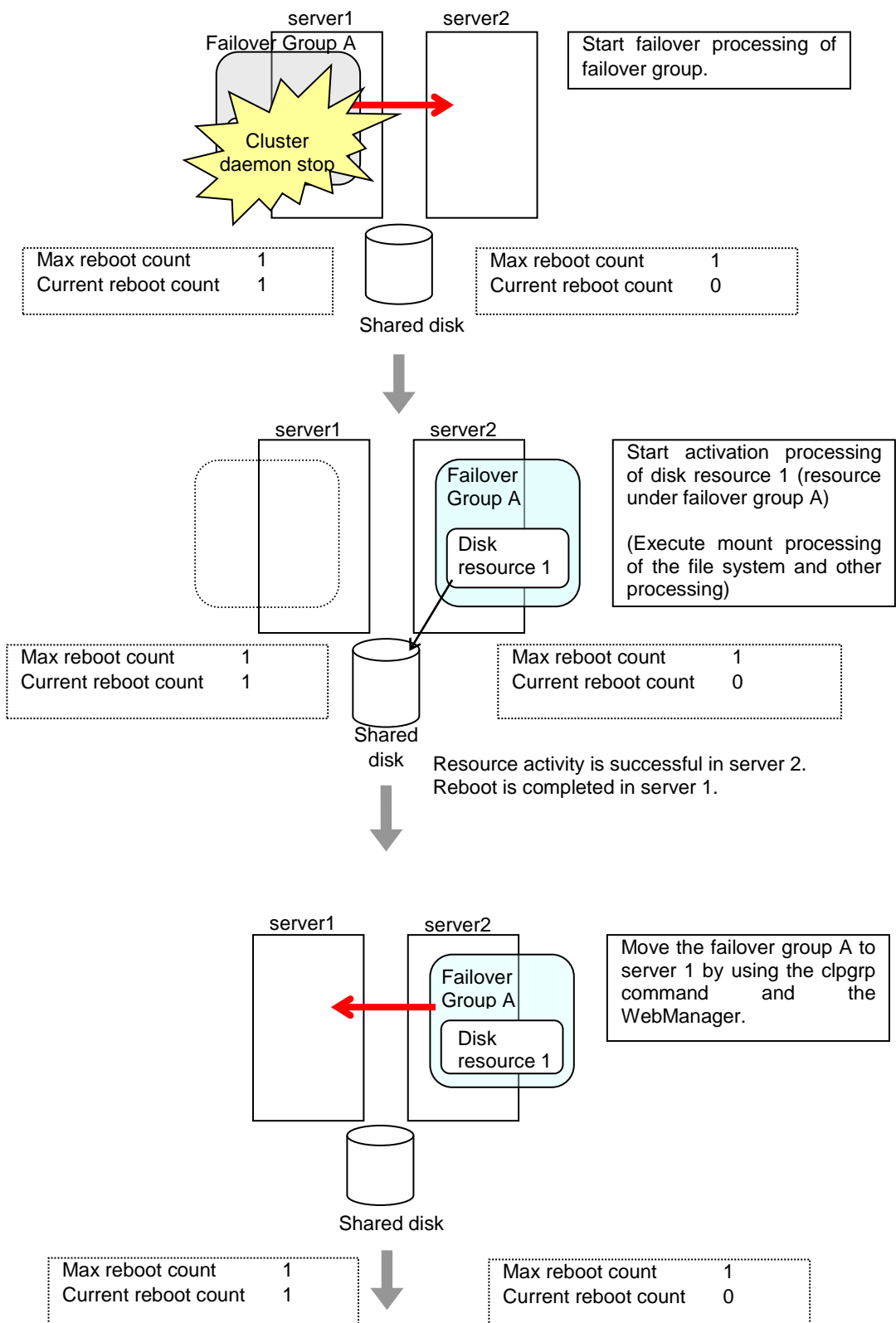

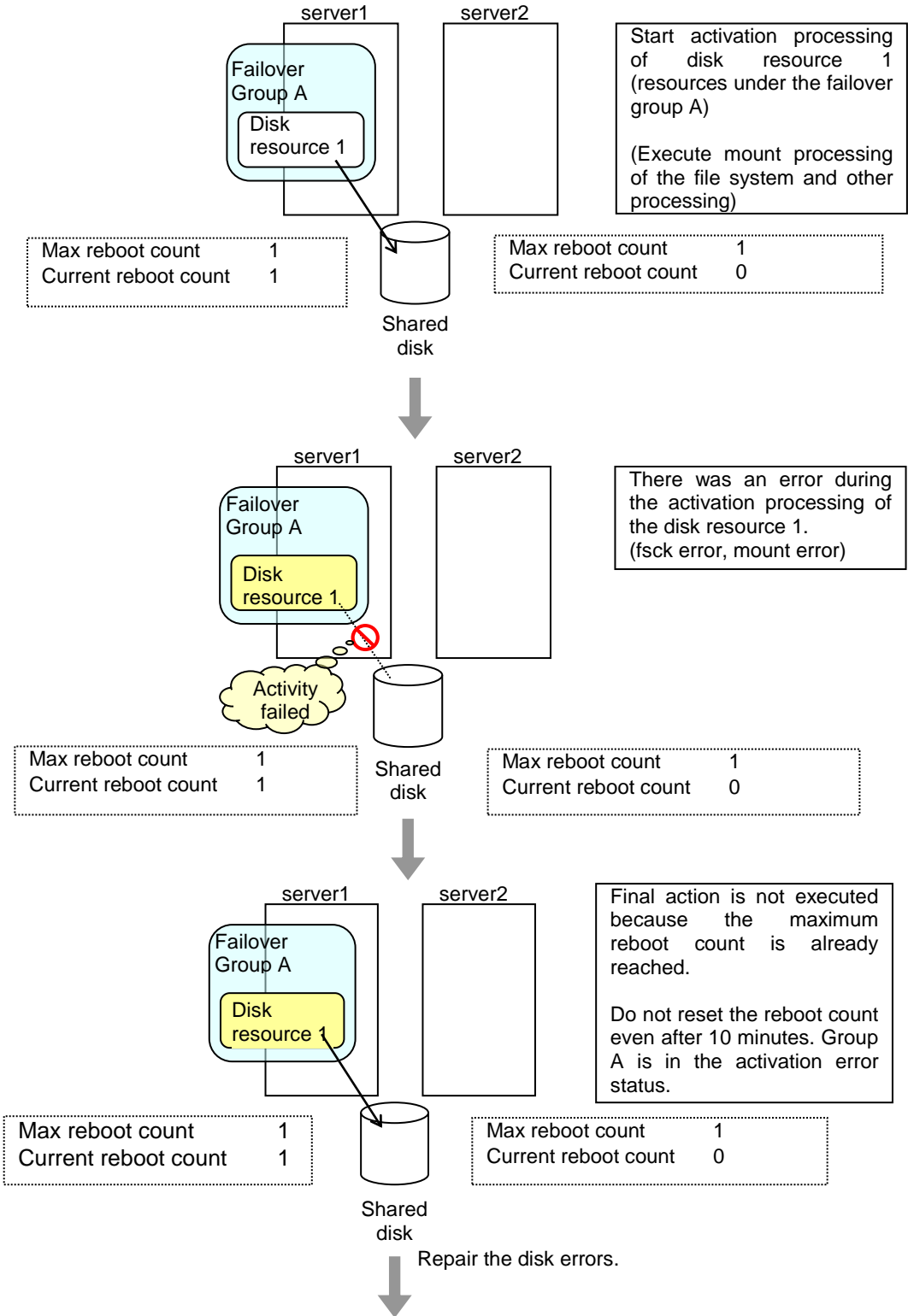

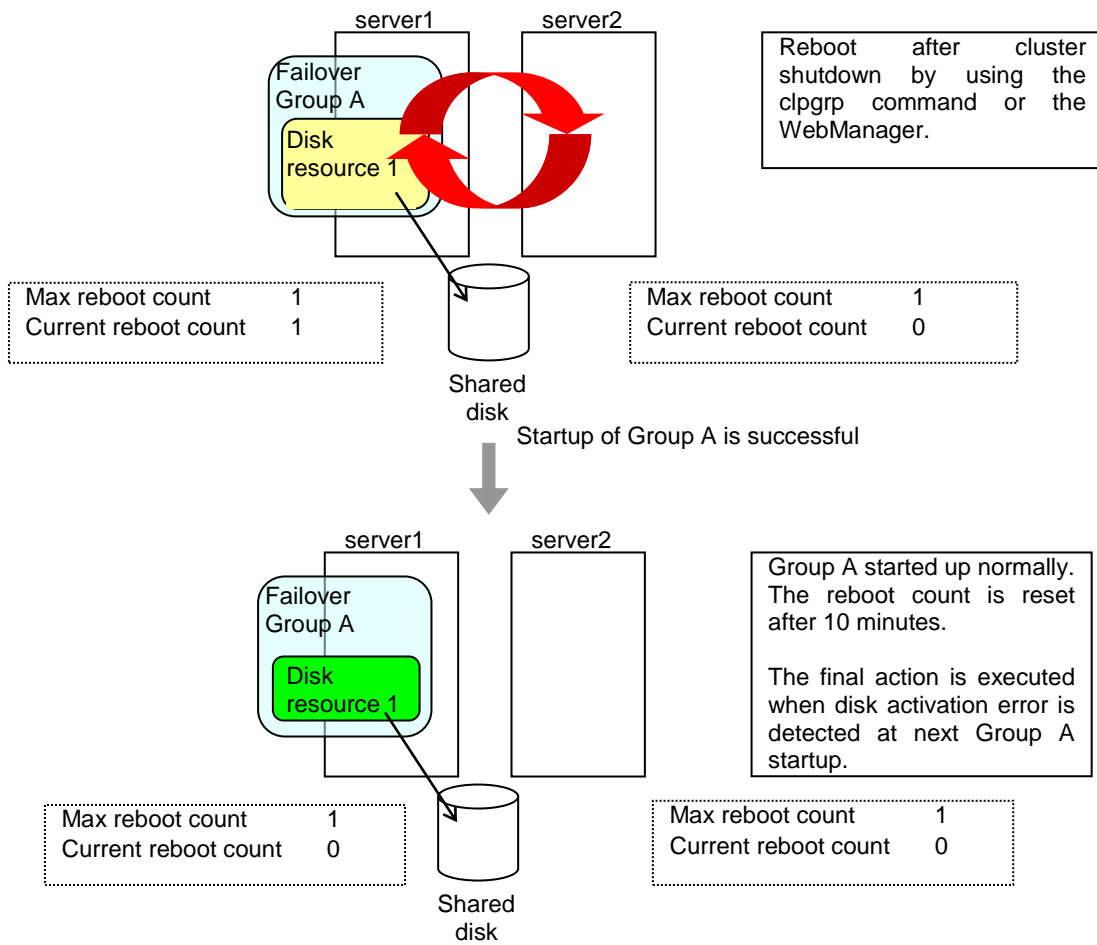

## Resetting the reboot count

Run the `clpregctl` command to reset the reboot count. For details on the `clpregctl` command, see “Controlling reboot count (`clpregctl` command)” in Chapter 3, “EXPRESSCLUSTER command reference” in this guide.

## Group start dependence and group stop dependence

You can control the group start order by setting the group to which you want to apply start dependence and that to which you want to apply stop dependence.

Note that, regarding group stop dependence, a group stop operation of the WebManager or `clpgrp` command does not apply stop dependence. Group stop dependence is applied according to the setting (when the cluster or a server stops) made with the Builder.

The following explains group start execution using examples of simple status transition.

### When two servers have three groups

#### Group failover policy

```
groupA server1
groupB server2
groupC server1 → server2
```

#### Group start dependence setting

groupA Start dependence is not set.

groupB Start dependence is not set.

groupC groupA start dependence is set.

groupC Start dependence is set when groupC is started by the server of groupB.

1. When server1 starts groupA and groupC

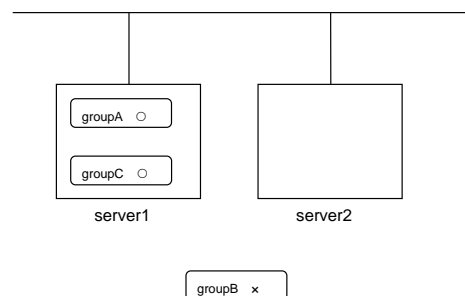

server1 starts groupC after groupA has been started normally.

2. When server1 starts groupA and server2 starts groupC

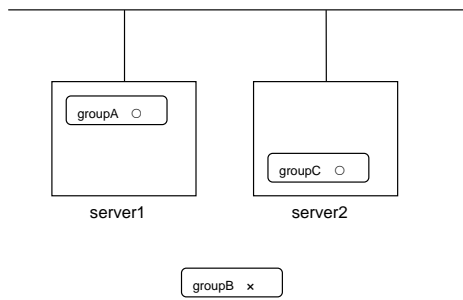

server2 starts groupC after server1 has started groupA normally.

**Wait Only when on the Same Server** is not set, so groupA start dependence by another server is applied.

3. When server1 starts groupC and server2 starts groupB

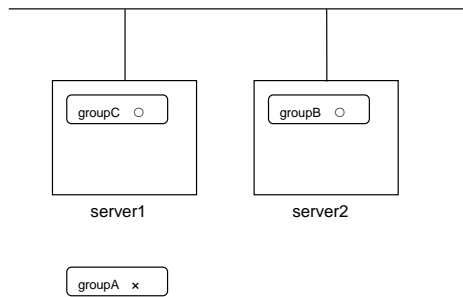

server1 starts groupC without waiting for the normal start of groupB. groupC is set to wait for groupB start only when it is started by the same server. However, start dependence is not applied to groupC because groupB is set such that it is not started by server1.

4. When server1 starts groupA and groupC

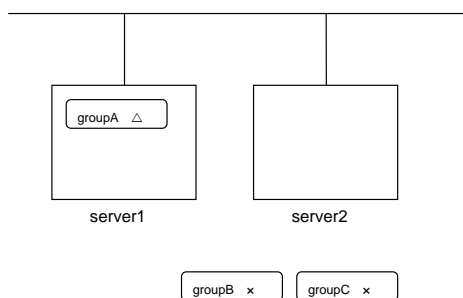

If server1 fails in groupA start, groupC is not started.



5. When server1 starts groupA and groupC

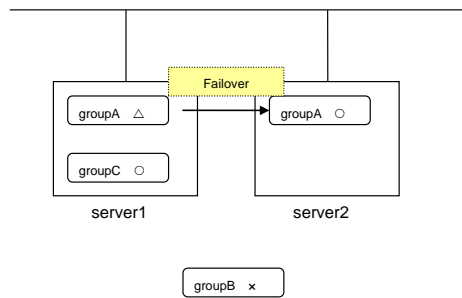

If server1 fails in groupA start and a failover occurs in server2 due to groupA resource recovery, server2 starts groupA and then server1 starts groupC.

6. When server1 starts groupA and groupC

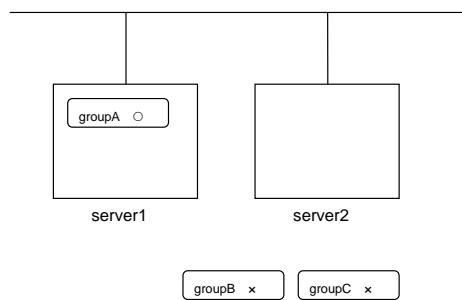

If a groupA start dependence timeout occurs on server1, groupC is not started.

7. When server1 starts only groupC

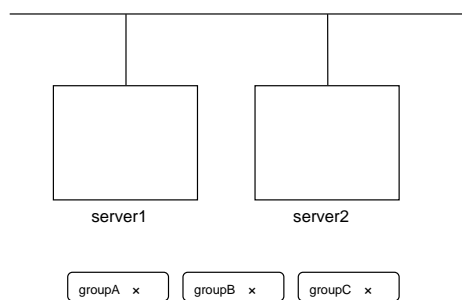

server1 has not started groupA, so a start dependence timeout occurs. If this timeout occurs, groupC is not started.

---

**Notes:**

- ◆ When a group is started, there is no function to automatically start the group for which start dependence is set.
  - ◆ The group is not started if a timeout occurs in the group for which start dependence is set.
  - ◆ The group is not started if the group for which start dependence is set fails to start.
  - ◆ If the group for which start dependence is set contains a normally started and a normally stopped resource, the group is judged to have started normally.
  - ◆ When a group is stopped, there is no function to automatically stop the group for which stop dependence is set.
  - ◆ The group stop processing continues if a timeout occurs in the group for which stop dependence is set.
  - ◆ The group stop processing continues if the group for which stop dependence is set fails to stop.
  - ◆ Stop waiting is not performed by group stop processing and server stop processing. Stop waiting is performed only by a cluster stop or a cluster shutdown.
  - ◆ The group stop processing or resource stop processing by the WebManager or clpgrp command does not apply stop dependence. Stop dependence is applied according to the setting (when the cluster or a server stops) made with the Builder.
  - ◆ If a start waiting timeout occurs at the time of a failover, the failover fails.
-

## Displaying and changing the settings of group properties

You can display and change the settings of the group properties by using **Group Properties** of the Builder.

### Renaming a group (Group properties)

1. In the tree view in the left pane of the Builder, right-click the icon of the group that you want to rename, and then click **Rename Group**.
2. The **Change Group Name** dialog box is displayed. Enter a new name.

### Displaying and changing the comment of a group (Group properties)

1. In the tree view in the left pane of the Builder, right-click the icon of the group that you want to change its comment, and then click **Properties**. The **Group Properties** dialog box is shown.
2. On the **Info** tab, the group name and comment are displayed. Enter a new comment.

---

**Note:**

You cannot change the group name on the **Info** tab. To change the group name, right-click the icon of the group as described in the step 1 above. Click **Rename Group** and enter a new name.

---

### Displaying and changing the settings of servers that start up the group (Group properties)

There are two types of settings for the server that starts up the group: starting up the group on all servers or on only the specified servers and server groups that can run the group.

If the setting on which the group is started up by all the servers is configured, all the servers in a cluster can start a group. The group startup priority of servers is same as the one of servers. For details on the server priority, see “Server property Master Server tab” in Chapter 2 “Functions of the Builder” in this guide.

When selecting servers and server groups that can run the group, you can select any server or server group from those registered to the cluster. You can also change the startup priority of servers and server groups that can run the group.

Run the following steps when setting the server group which start up the failover group.

1. In the tree view in the left pane of the Builder, right-click the icon of the group with servers whose settings you want to display and change, and then click **Properties**. The **Group Properties** dialog box is displayed.
2. When setting the servers that can run the group, check **Use Server Group Settings** in **Info** tab off.
3. Select the **Startup Server** tab. In **Servers that can run the Group**, servers that can start the group and their order are shown. In **Available Servers**, the servers that can be registered with **Servers that can run the Group** are shown.

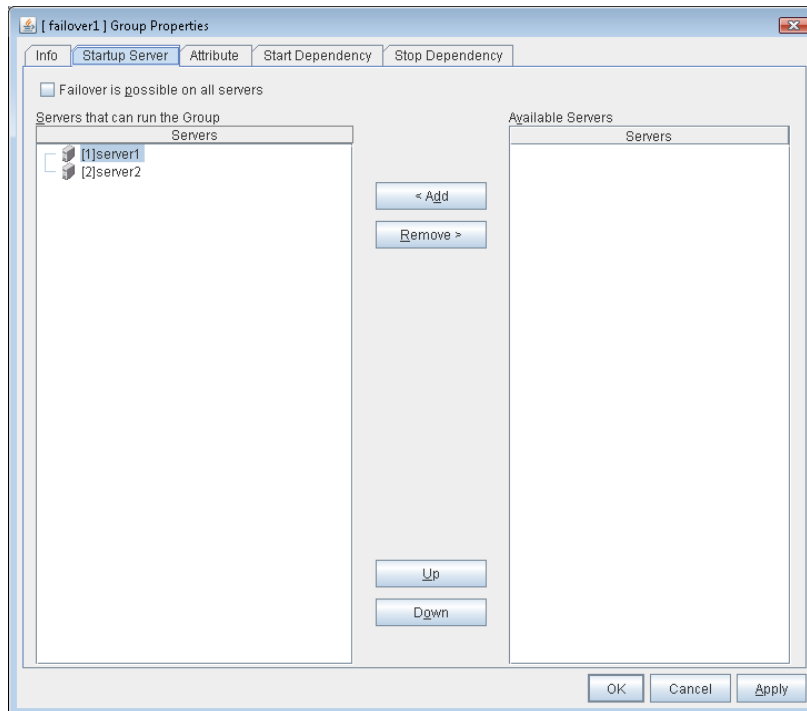

4. Set the startup servers by following the procedures below:

**Failover is possible on all servers**

Specify the server that starts a group.

- When the check box is selected  
All servers registered to a cluster can start a group. The priority of starting up a group is same as the one of the servers.
- When not selected  
You can select the servers that can start a group, and change the startup priority.

**Add**

Use this button to add a server. Select a server that you want to add from **Available Servers**, and then click **Add**. The server is added to **Servers that can run the Group**.

**Remove**

Use this button to remove a server. Select a server that you want to remove from **Servers that can run the Group**, and then click **Remove**. The server is added to **Available Servers**.

**Up, Down**

Use these buttons to change the priority of the servers that can be started. Select a server whose priority you want to change from **Servers that can run the Group**. Click **Up** or **Down** to move the selected row upward or downward.

## Displaying and changing the settings of server group that starts up the group (Group properties)

It is necessary to configure a server group that starts up the failover group for the settings of a server that starts up a group including a hybrid disk resource.

1. In the tree view in the left pane of the Builder, right-click the icon of the group with servers whose settings you want to display and change, and then click **Properties**. The **Group Properties** dialog box is displayed.
2. When using the settings of the server group, check **Use Server Group Settings** on.
3. Click **Server Groups** tab. In **Servers that can run the Group**, servers that can start the group and their order are shown. The smaller number a server has, the higher its priority is. In **Available Server Groups**, the servers that can be registered in **Server Groups that can run the Group** are displayed.

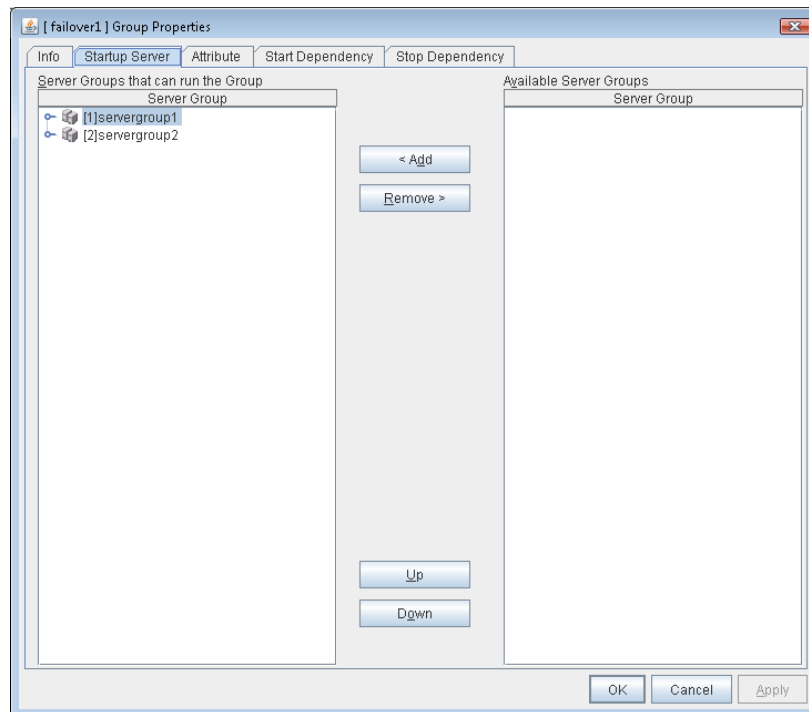

4. Configure **Server Groups that can run the Group** according to the following description:

### Add

Use **Add** to add a server group to **Server Groups that can run the Group**. Select a server group that you want to add from **Available Server Groups**, and then click **Add**. The selected server group is added to **Server Groups that can run the Group**.

### Remove

Use **Remove** to remove a server group from **Server Groups that can run the Group**. Select a server group that you want to remove from **Available Server Groups**, and then click **Remove**. The server is added to **Server Groups that can run the Group**.

### Up, Down

Use these buttons to change the priority of a server group. Select a server group whose priority you want to change from **Server Groups that can run the Group**. Click **Up** or **Down** to move the selected row upward or downward.

## Displaying and changing the group attribute (Group properties)

1. In the tree view in the left pane of the Builder, right-click the icon of the group that you want to show/change its settings of the attribute, and then click **Properties**. The **Group Properties** dialog box is displayed.
2. Click the **Attribute** tab. Specify **Startup Attribute**, **Failover Attribute**, **Failback Attribute**, and **Failover Exclusive Attribute** of this group by following the procedures on the next page:

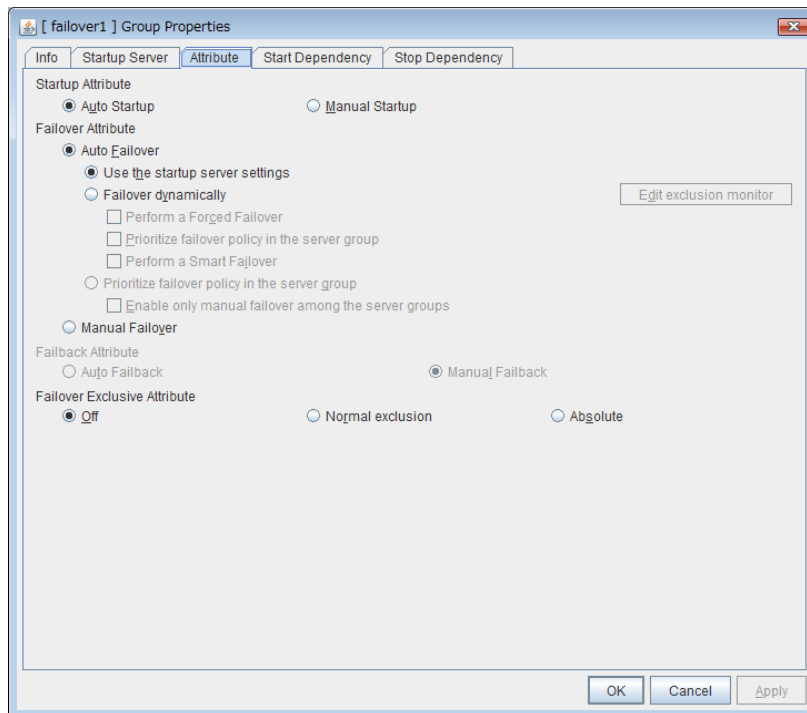

### Startup Attribute

Select whether to automatically start the group from EXPRESSCLUSTER (auto startup), or to manually start from the WebManager or by using the clpgrp command (manual startup) at the cluster startup.

- **Auto Startup**  
The group will automatically be started at the cluster startup (active state).
- **Manual Startup**  
The group will not be started at the cluster startup (inactive state).  
You can start the group from the WebManager or by using the clpgrp command (active state).

### Failover Attribute

Select if the failover is automatically performed when a server fails.

- Auto Failover  
Failover is executed automatically. In addition, the following options can be selected.
  - Use the startup server settings  
This is the default setting.
  - Fail over dynamically  
The failover destination is determined by considering the statuses of each server's monitor or failover group at the time of the failover.  
  
If this option button is selected, all the failover exclusive attribute and failback attribute parameters are reverted to the default values and grayed out.  
  
If dynamic failover is selected, each option can be set. For details, see "Understanding the group properties".
- Prioritize failover policy in the server group  
This function controls failovers between sites (between server groups).  
  
However, if no server group is specified for the failover group, the display for failovers between sites is grayed out.  
  
If this option button is selected, the failover exclusive attribute is changed to the default value and the display is grayed out. The **Enable only manual failover among the server groups** check box can be selected only when this option button is selected.  
  
If the **Prioritize failover policy in the server group** option button is selected, the failover policies in the same server group take priority when determining the failover destination.  
  
If the **Prioritize failover policy in the server group** option button and **Enable only manual failover among the server groups** check box are selected, failovers across server groups are not automatically performed. Manually move groups between server groups.
- Manual Failover  
Failover is executed manually.

### Failback Attribute

Select if the failback is executed automatically to the group when a server that has a higher priority than other server where the group is active is started. For groups that have mirror disk resources or hybrid disk resources, select manual failback.

- Auto Failback  
Failback is executed automatically.
- Manual Failback  
Failback is not executed automatically.

### Failover Exclusive Attribute

This attribute determines the server to which EXPRESSCLUSTER automatically fails over. You can select from Off, Exclusion, and Absolute.

- Off  
This is always the top priority server. Multiple groups may be started on the same server.
- Exclusion  
This is the top priority server among servers where no group of Exclusion is active. If all servers have an active group of Exclusion, the group fails over to the top priority server. Multiple groups may be started on the same server
- Absolute  
This is the top priority server among servers where no group of Absolute is active. If all servers have an active group of Absolute, the group does not fail over. More than one group of Absolute cannot be started on the same server.  
It is not recommended to specify this in 2-server cluster systems (the group does not fail over in 2-server configurations in many cases).

---

#### Note:

If **Fail over dynamically** is selected for **Failover Attribute**, **Failover Exclusive Attribute** cannot be set.

---

### Edit Exclusive Monitor

Dynamic failover excludes the server for which the monitor resource has detected an error, from the failover destinations. If **Fail over dynamically** is selected as the failover attribute, you can set the monitor resource to be excluded.

The exclusive list can be set with the monitor resource type and monitor resource name.

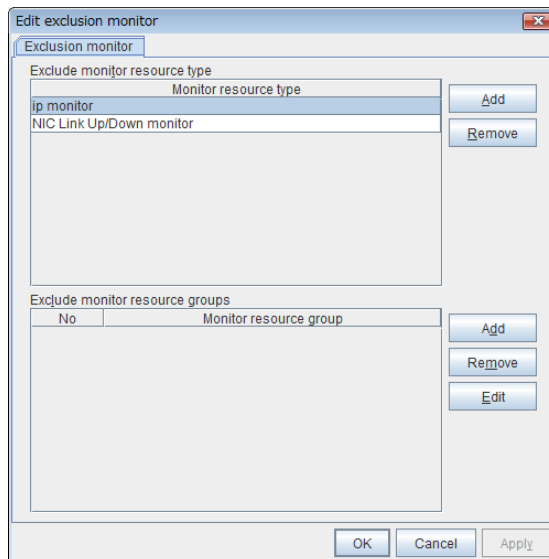



- Add exclusive monitor resource type

Adds the exclusive monitor resource type.

Any server, in which even one monitor resource of the added monitor resource type is abnormal, is excluded from the failover destinations.

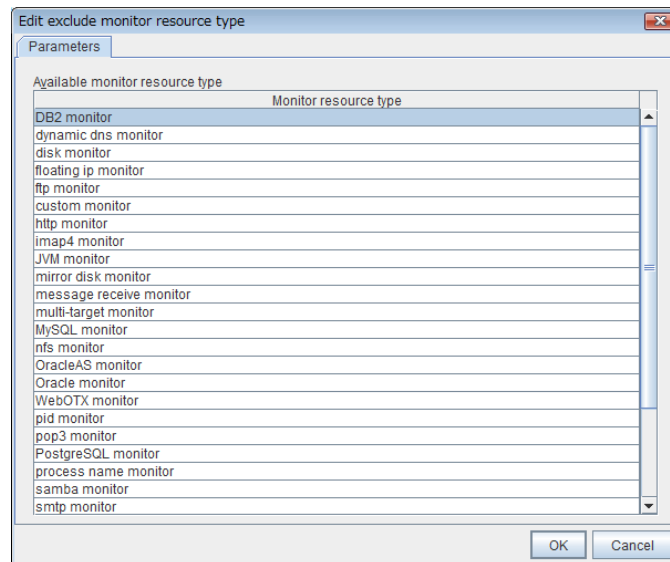

Adds the selected monitor resource type.

- Remove exclusive monitor resource type

Removes the selected exclusive monitor resource type.

- Add exclusive monitor resource group

Adds the exclusive monitor resource group.

The maximum number of exclusive monitor resource groups to be registered is 32.

If multiple monitor resources are registered in a single exclusive monitor resource group, the server in which all the registered monitor resources are abnormal is excluded from the failover destinations.

Moreover, if multiple exclusive monitor resource groups are registered, a server that satisfies at least one of the conditions is excluded from the failover destinations.

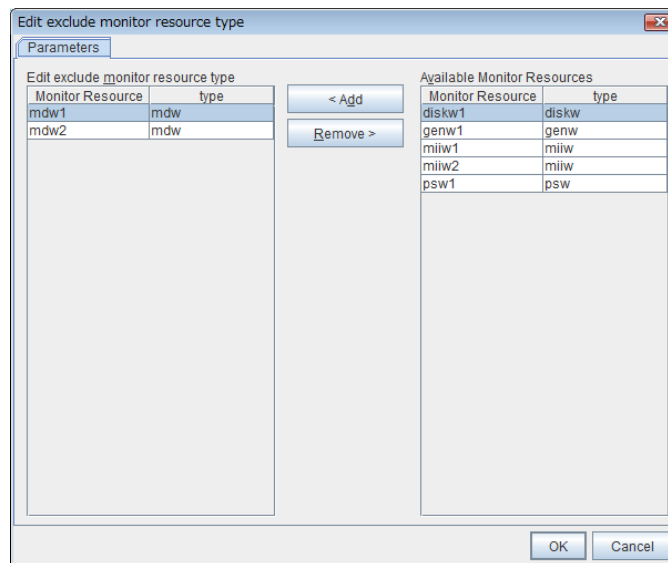
**Add**

Adds the monitor resource selected from **Available monitor resource list** to **Monitor resource list**.

**Remove**

Removes the monitor resource selected with **Monitor resource list**, from the list.

- Delete exclusive monitor resource group  
Removes the selected exclusive monitor resource group.
- Edit exclusive monitor resource group  
Edits the selected exclusive monitor resource group.

**Note:**

The following monitor resource types cannot be registered for the exclusive monitor resource type. Moreover, a resource name cannot be registered for the exclusive monitor resource group.

- User-mode monitor
- ARP monitor
- Virtual IP monitor
- Mirror disk connect monitor
- Hybrid disk monitor
- Hybrid disk connect monitor

**Note:**

The monitor resource in the warning status is not handled as being abnormal. The exception to this is the mirror disk monitor resource.

The monitor resource set for monitoring at activation does not enter the abnormal status because it does not perform monitoring for a server other than the group start server.

The monitor resource stopped with the WebManager or `clpmonctrl` command enters the normal status.

A server that has not been set to monitor a monitor resource does not enter the abnormal status because it does not perform monitoring.

---

---

**Note:**

In the case of the mirror disk monitor resource, a check is made as to whether the mirror disk resource can be activated. There is no dependence on the status of the mirror disk monitor resource.

Even if the mirror disk monitor resource is in the error status, the server on which the mirror disk resource can be activated normally is not excluded from the failover destination.

Even if the mirror disk monitor resource is in the normal or caution status, the server on which the mirror disk resource cannot be activated normally is excluded from the failover destination.

---

---

**Note:**

If the internal version is 3.1.4-1 or earlier, group reactivation or group resource reactivation by the recovery action cannot work while the exclusive monitor resource detects an error.

If the internal version is 3.1.5-1 or later, group reactivation or group resource reactivation can work. If you update it to 3.1.5-1 or later, please be careful about what the behavior of the recovery action may change.

---

## Understanding setting of group start dependence and group stop dependence

You can set the group start and stop order by setting group start dependence and group stop dependence.

- ◆ When group start dependence is set:
  - For group start, start processing of this group is performed after start processing of the group subject to start dependence completes normally.
  - For group start, if a timeout occurs in the group for which start dependence is set, the group does not start.
- ◆ When group stop dependence is set:
  - For group stop, stop processing of this group is performed after stop processing of the group subject to stop dependence completes normally.
  - If a timeout occurs in the group for which stop dependence is set, the group stop processing continues.
  - Stop waiting isn't performed by group stop processing of WebManager or the clpgrp command. Stop waiting is performed only according to the condition specified by Builder (a cluster stop or a cluster shutdown).

To display the settings made for group start dependence and group stop dependence, click the **Groups** icon in the tree view displayed in the left part of Builder and then click the **Start Dependence** tab and the **Stop Dependence** tab in the table view displayed in the right part.

Depths for group start dependence are listed below as an example.

Group	Start Dependence	Stop Dependence
Depth	Name	Dependent Group Name
0	failover1	none
1	failover2	failover1
2	failover3	failover2

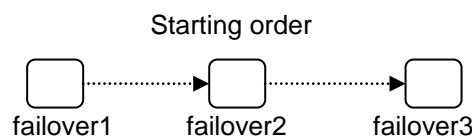

## Displaying and configuring group start dependence and group stop dependence

Set the start dependence and stop dependence for each group.

1. In the tree view displayed in the left part of Builder, click the **Groups** icon.
2. Groups are listed in the table view in the right part. Right-click the group for which you want to display and set dependence and then click the **Start Dependency** tab and the **Stop Dependency** tab of **Properties**.
3. Set the start dependence according to the following description:
  - From **Available Group**, select a start dependence target group.
  - Click **Add**.
  - The added group is added to **Dependent Group**.
  - To change the properties, select a group from **Dependent Group**.
  - Click **Property**.
  - Select the **Wait Only when on the Same Server** check box.
4. Set the stop dependence according to the following description:
  - From **Available Group**, select a stop dependence target group.
  - Click **Add**.
  - The selected group is added to **Dependent Group**.
  - If you want to apply group stop dependence when the cluster stops, select **Wait the Dependent Groups when a Cluster Stops**.
  - If you want to apply group stop dependence when a server stops, select **Wait the Dependent Groups when a Server Stops**.

### Group Properties – Start Dependency tab

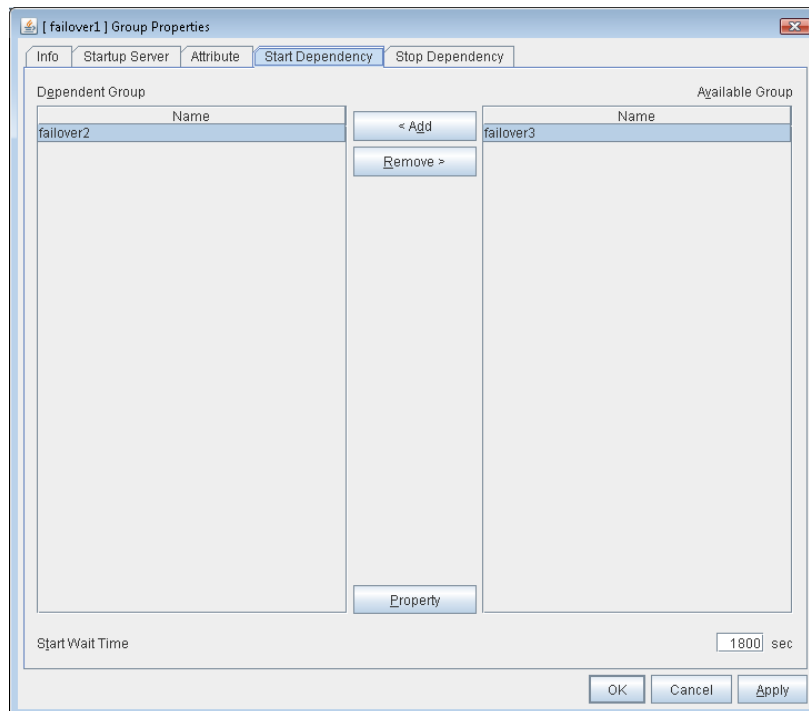

#### Add

Clicking **Add** adds the group selected from **Available Group** to **Dependent Group**.

#### Remove

Clicking **Remove** removes the group selected from **Dependent Group** from **Dependent Group**.

#### Start Wait Time 0 to 9999

Specify how many seconds you want to wait before a timeout in the target group start process. The default value is 1800 seconds.

### Property

Clicking **Property** changes the properties of the group selected from **Dependent Group**.

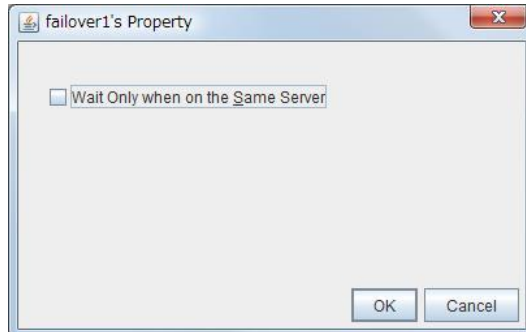

### Wait Only when on the Same Server

Specify whether you wait for start waiting only when the group which starts waiting and the target group start on the same server.

- When **Wait Only when on the Same Server** is selected
  - When the server which starts the group that starts waiting isn't included in the Startup Server of a target group, you don't wait.
  - When a target group fails to start on a server other than the server which starts the group that starts waiting, you don't wait.

### Group Properties – Stop Dependency tab

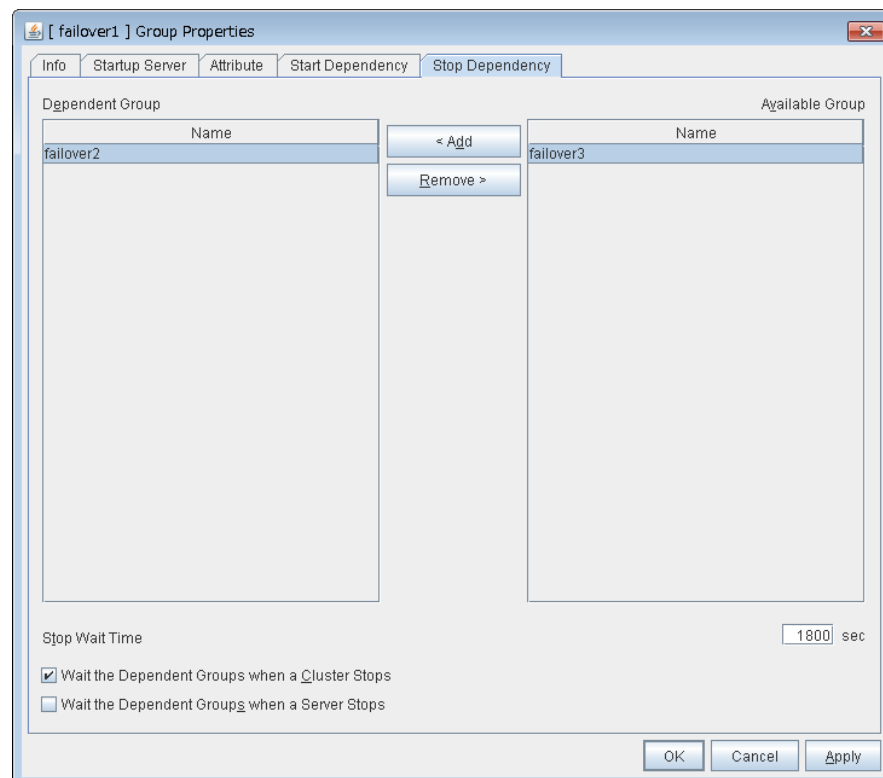

**Add**

Clicking **Add** adds the group selected from **Available Group** to **Dependent Group**.

**Remove**

Clicking **Remove** removes the group selected from **Dependent Group** from **Dependent Group**.

**Stop Wait Time** 0 to 9999

Specify how many seconds to wait before a timeout occurs in the target group stop processing. The default value is 1800 seconds.

**Wait the Dependent Groups when a Cluster Stops**

Specify whether to wait for the dependent groups to stop when the cluster stops.

**Wait the Dependent Groups when a Server Stops**

Specify whether to wait for the dependent groups to stop when a single server stops. This option waits for the stop of only those groups running on the same server, among all the dependent groups.



## Displaying and changing the settings of group resources

You can display and change the settings of the group resources by using the **Resource Properties** in the Builder.

### Renaming a group resource (Group properties)

1. In the tree view in the left pane of the Builder, click the icon of the group to which the group resource that you want to rename belongs. The list of selected group resources is shown on the table view in the right pane of the screen.
2. Right-click the name of the group resource that you want to rename, and then click **Rename Resource**.
3. The **Change Resource Name** dialog box is displayed. Enter a new name.

### Displaying and changing the comment of a group resource (Group properties)

1. In the tree view in the left pane of the Builder, click the icon of the group to which the group resource whose comment you want to change belongs. Group resources of the selected group will be listed on the table view in the right pane of the screen.
2. Right-click the name of the group resource whose comment you want to display or change, and click **Resource Properties**.
3. On the **Info** tab, the group resource name and comment are shown. Enter new comment (within 127 bytes).

---

**Note:**

You cannot change the group resource name on the **Info** tab. To change the group name, right-click the icon of the group resource as described in the step 1 above. Click **Rename Group** and enter new name.

---

## Understanding the settings of dependency among group resources (Common to group resources)

By specifying dependency among group resources, the order of activating them can be specified.

- ◆ When the dependency among group resources is set:
  - When activating a failover group that a group resource belongs to, its activation starts after the activation of the Dependent Resources is completed.
  - When deactivating a group resource, the deactivation of the “Dependent Resources” starts after the deactivation of the group resource is completed.

To display the settings of dependency among group resources, click the icon of the group whose group resources dependency you want to view on the tree view shown in the left pane of the Builder, and then click the **Entire Dependency** tab on the table view shown in the right pane of the Builder.

Depths for group start dependence are listed below as an example.

Group	Start Dependency	Stop Dependency
Depth	Name	Dependent Group Name
0	failover1	none
1	failover2	failover1
2	failover3	failover2

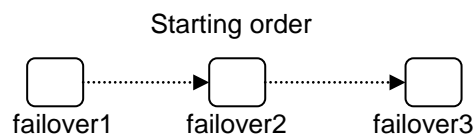

## Displaying and configuring the settings of dependency among group resources (Common to group resources)

Set the dependent group resources on a group resource basis.

1. In the tree view shown in the left pane of the Builder, click the icon of the group to which the group resource whose settings of dependency you want to display or configure belongs.
2. The list of group resources is shown in the table view in the right pane. Right-click the group resource whose dependency settings you want to display and configure. Click **Properties**, and then click the **Dependency** tab.
3. Set the dependency as described below:
  - When Follow the default dependence is selected:
    - Default dependency resource type is shown in **Dependent Resources**.
    - Nothing is shown in **Available Resources**.
  - When Follow the default dependence is not selected:
    - Group resource names and types are shown in **Dependent Resources**.
    - Group resources that can be added to Dependent Resources are listed in Available Resources. Group resources whose dependency is looped (that depend on depended group resource) are not shown. Group resources in Dependent Resources are not shown either.

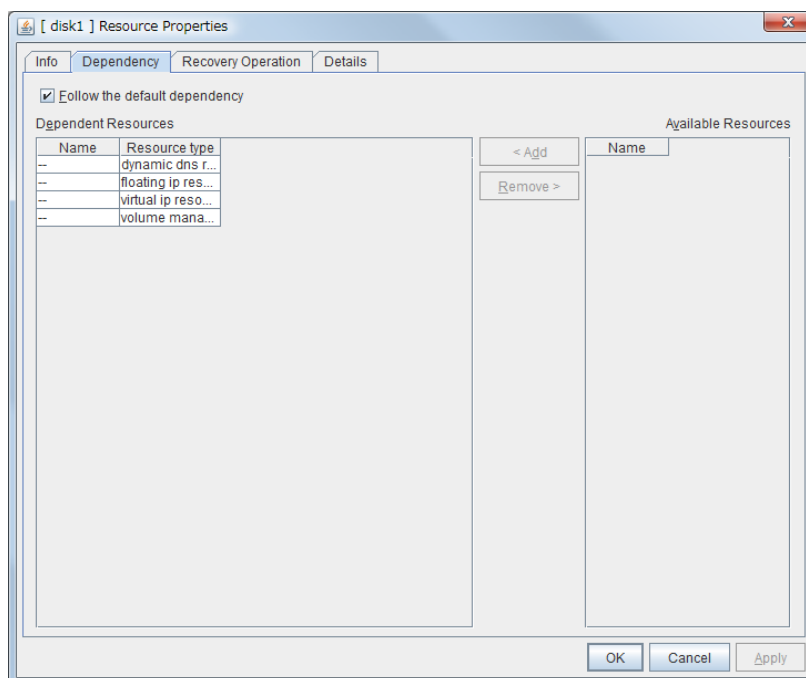

### **Follow the default dependence**

Select if the selected group resource follows the default EXPRESSCLUSTER dependency.

- When Follow the default dependence is selected:  
The selected group resource depends on the type(s) of resources.  
See “Parameters list” in Chapter 2, “Functions of the Builder” for the default dependency of each resource.  
When there is more than one resource of the same type, the selected group resource depends on all resources of that type.
- When Follow the default dependence is not selected:  
The selected group resource depends on the specified resource.

### **Add**

It is used when adding the group resource selected in **Available Resources** to **Dependent Resources**.

### **Remove**

It is used when removing the group resource selected in **Dependent Resources** from **Dependent Resources**.

## Displaying and changing the operation settings when a group resource error is detected (Common to group resources)

You can display and change the operation settings of actions when a group resource error is detected (when group resources are active/inactive) by using the **Recovery Operation** tab of the Builder.

1. In the tree view shown in the left pane of the Builder, click the icon of the group to which the group resource whose behavior at the time when a group resource error is detected you want to view or change.
2. The list of group resources is shown in the table view on the right pane. Right-click the group resource which you want to display and change the behavior at the time when a group resource error is detected. Click the **Recovery Operation** tab of **Properties**.
3. Specify the behavior at the time when a group resource error is detected by following the procedures below:
  - When an error in activation of the group resource is detected:
    - When an error is detected while activating the group resource, try activating it again.
    - When the activation retry count exceeds the number of times set in **Retry Count at Activation Failure**, failover is executed.
    - When the group resource cannot be activated even after executing a failover as many times as specified in **Failover Threshold**, the final action is taken.
  - When an error in deactivation of the group resource is detected:
    - When an error is detected while deactivating the group resource, try deactivating it again.
    - When the deactivation retry count exceeds the number of times set in **Retry Count at Deactivation Failure**, the final action is taken.

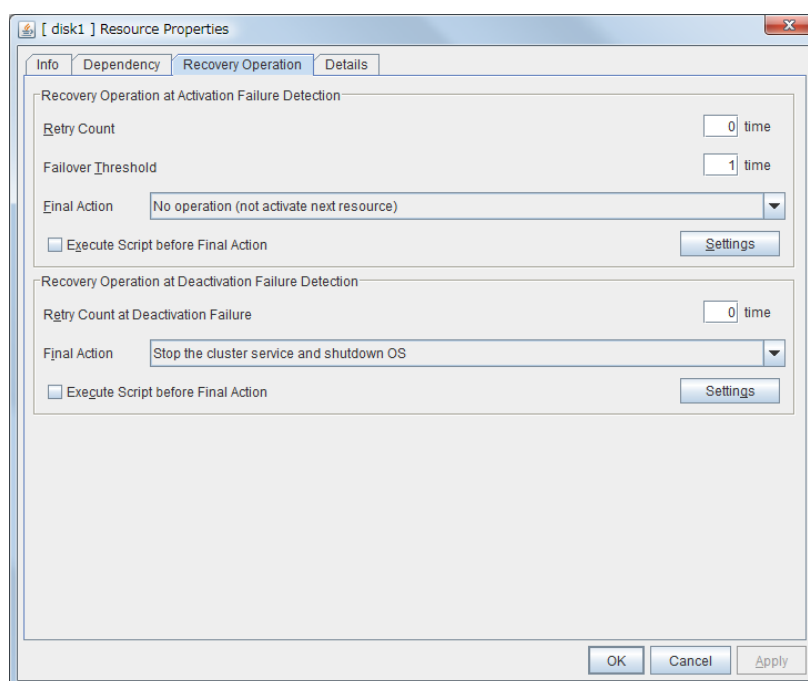

**Retry Count at Activation Failure** 0 to 99

Enter how many times to retry activation when an activation error is detected. If this is set to zero (0), the activation will not be retried.

**Failover Threshold** 0 to 99

Enter how many times to retry failover after activation retry fails as many times as the number of times set in **Retry Count at Activation Failure** when an error in activation is detected.

If this is set to zero (0), failover will not be executed.

**Final Action**

Select an action to be taken when activation retry failed the number of times specified in **Activation Retry Threshold** and failover failed as many times as the number of times specified in **Failover Threshold** when an activation error is detected.

Select a final action from the following:

- **No Operation (Activate next resource):**  
Continues the group start process.
- **No Operation (Not activate next resource):**  
Cancels the group start process.
- **Stop Group:**  
Deactivates all resources in the group of which the group resource that an activation error is detected.
- **Stop cluster service:**  
Stops the cluster service of the server of which an activation error is detected.
- **Stop cluster service and shutdown OS:**  
Stops the cluster service of the server of which an activation error is detected, and shuts down the OS.
- **Stop cluster service and reboot OS:**  
Stops the cluster service of the server where an activation error is detected, and restarts the OS.
- **Sysrq Panic:**  
Performs the sysrq panic.

---

**Note:**

If performing the sysrq panic fails, the OS is shut down.

---

- **Keepalive Reset:**  
Resets the OS using the clpkhb or clpka driver.

---

**Note:**

If resetting keepalive fails, the OS is shut down. Do not select this action on the OS and kernel where the clpkhb and clpka drivers are not supported

---

- **Keepalive Panic:**  
Performs the OS panic using the clpkhb or clpka driver.

---

**Note:**

If performing the keepalive panic fails, the OS is shut down. Do not select this action on the OS and kernel where the clpkhb and clpka drivers are not supported.

---

- **BMC Reset:**  
Perform hardware reset on the server by using the ipmi command.

---

**Note:**

If resetting BMC fails, the OS is shut down. Do not select this action on the server where the ipmitool or the ipmiutil is not installed, or the ipmitool command, the hwreset command or the iredet command does not run.

---

- **BMC Power Off:**  
Powers off the OS by using the ipmi command. OS shutdown may be performed due to the ACPI settings of the OS.

---

**Note:**

If powering off BMC fails, the OS is shut down. Do not select this action on the server where the ipmitool or the ipmiutil is not installed, or the ipmitool command, the hwreset command or the iredet command does not run.

---

- **BMC Power Cycle:**  
Performs the power cycle (powering on/off) of the server by using the ipmi command. OS shutdown may be performed due to the ACPI settings of the OS.

---

**Note:**

If performing the power cycle of BMC fails, the OS is shut down. Do not select this action on the server where the ipmitool or the ipmiutil is not installed, or the ipmitool command, the hwreset command or the iredet command does not run.

---

- **BMC NMI:**  
Uses the ipmi command to cause NMI occur on the server. Actions after NMI occurrence depend on the OS settings.

---

**Note:**

If BMC NMI fails, the OS shutdown is performed. Do not select this action on the server where the ipmitool or the ipmiutil is not installed, or the ipmitool command, the hwreset command or the iredet command does not run.

---

- **I/O Fencing(High-End Server Option):**  
Use this on the server in network partition to generate I/O Fencing and NMI.

---

**Note:**

If I/O Fencing(High-End Server Option) fails, the OS shutdown is performed.

---

### Execute Script before Final Action

Select whether script is run or not before executing final action when an activation failure is detected.

- When the check box is selected:  
A script/command is run before executing final action. To configure the script/command setting, click **Settings**.
- When the check box is not selected:  
Any script/command is not run.

### Retry Count at Deactivation Failure (0 to 99)

Enter how many times to retry deactivation when an error in deactivation is detected.

If you set this to zero (0), deactivation will not be retried.

### Final Action

Select the action to be taken when deactivation retry failed the number of times specified in **Retry Count at Deactivation Failure** when an error in deactivation is detected.

Select the final action from the following:

- No Operation (Deactivate next resource):  
Continue the group stop process.

---

**Note:**

If **No Operation** is selected as the final action when a deactivation error is detected, group does not stop but remains in the deactivation error status.  
Make sure not to set **No Operation** in the production environment.

---

- No Operation (Not deactivate next resource):  
Cancel the group start process.

---

**Note:**

If **No Operation** is selected as the final action when a deactivation error is detected, group does not stop but remains in the deactivation error status.  
Make sure not to set **No Operation** in the production environment.

---

- Stop cluster service and shutdown OS:  
Stop the cluster daemon on the server of which error in deactivation is detected, and shut down the OS.
- Stop cluster service and reboot OS:  
Stop the cluster daemon on the server where an error in deactivation is detected, and restart the OS.
- Sysrq Panic:  
Performs the sysrq panic.

---

**Note:**

If performing the sysrq panic fails, the OS is shut down.

---

- Keepalive Reset:  
Resets the OS using the clpkhb or clpka driver.

---

**Note:**



If resetting keepalive fails, the OS is shut down. Do not select this action on the OS and kernel where the clpkhb and clpka drivers are not supported

---

- **Keepalive Panic:**  
Performs the OS panic using the clpkhb or clpka driver.
- 

**Note:**

If performing the keepalive panic fails, the OS is shut down. Do not select this action on the OS and kernel where the clpkhb and clpka drivers are not supported.

---

- **BMC Reset:**  
Perform hardware reset on the server by using the ipmi command.
- 

**Note:**

If resetting BMC fails, the OS is shut down. Do not select this action on the server where the ipmitool or the ipmiutil is not installed, or the ipmitool command, the hwreset command or the ireset command does not run.

---

- **BMC Power Off:**  
Powers off the OS by using the ipmi command. OS shutdown may be performed due to the ACPI settings of the OS.
- 

**Note:**

If powering off BMC fails, the OS is shut down. Do not select this action on the server where the ipmitool or the ipmiutil is not installed, or the ipmitool command, the hwreset command or the ireset command does not run.

---

- **BMC Power Cycle:**  
Performs the power cycle (powering on/off) of the server by using the ipmi command. OS shutdown may be performed due to the ACPI settings of the OS.
- 

**Note:**

If performing the power cycle of BMC fails, the OS is shut down. Do not select this action on the server where the ipmitool or the ipmiutil is not installed, or the ipmitool command, the hwreset command or the ireset command does not run.

---

- **BMC NMI:**  
Uses the ipmi command to cause NMI occur on the server. Actions after NMI occurrence depend on the OS settings.
- 

**Note:**

If BMC NMI fails, the OS shutdown is shut down. Do not select this action on the server where the ipmitool or the ipmiutil is not installed, or the ipmitool command, the hwreset command or the ireset command does not run.

---

- **I/O Fencing(High-End Server Option):**  
Use this on the server in network partition to generate I/O Fencing and NMI.
- 

**Note:**

If I/O Fencing(High-End Server Option) fails, the OS shutdown is performed.

---

### Execute Script before Final Action

Select whether script is run or not before executing final action when a deactivation failure is detected.

- When the check box is selected:  
A script/command is run before executing final action. To configure the script/command setting, click **Settings**
- When the check box is not selected:  
Any script/command is not run.

## Displaying and changing the script when a group resource activation/deactivation failure is detected

You can display and change the setting of a script which is run before executing final action when a group resource failure is detected (when group resources are active/inactive) by using the **Recovery Operation** tab of the Builder.

1. In the tree view shown in the left pane of the Builder, click the icon of the group to which the group resource whose behavior at the time when a group resource error is detected you want to display or change.
2. The list of group resources will be shown in the table view on the right pane. Right-click the group resource which you want to display and change the behavior at the time when a group resource error is detected. Click the **Recovery Operation** tab of **Properties**.
3. Click **Settings** in **Recovery Operation at Activation Failure Detection** or **Recovery Operation at Deactivation Failure Detection** to display the **Edit Script** dialog box. Set the script/command to be run before executing final action.

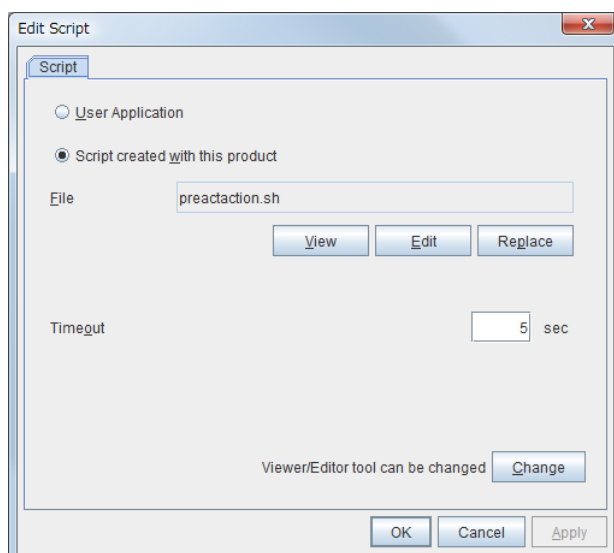

### User Application

Use an executable file (executable shell script file or execution file) on the server as a script. For the file name, specify an absolute path or name of the executable file of the local disk on the server. If there is any blank in the absolute path or the file name, put them in double quotation marks (“”) as follows.

Example:

```
“/tmp/user application/script.sh”
```

Each executable files is not included in the cluster configuration information of the Builder. They must be prepared on each server because they cannot be edited nor uploaded by the Builder.

### Script created with this product

Use a script file which is prepared by the Builder as a script. You can edit the script file with the Builder if you need. The script file is included in the cluster configuration information.

**File** (Within 1023 bytes)

Specify a script to be executed (executable shell script file or execution file) when you select **User Application**.

**View**

Click here to display the script file with an editor when you select **Script created with this product**. The information edited and stored with the editor is not applied. You cannot display the script file if it is currently displayed or edited.

**Edit**

Click here to edit the script file with the editor when you select **Script created with this product**. Overwrite the script file to apply the change. You cannot edit the script file if it is currently displayed or edited. You cannot modify the name of the script file.

**Replace**

Click here to replace the contents of a script file with the contents of the script file which you selected in the file selection dialog box when you select **Script created with this product**. You cannot replace the script file if it is currently displayed or edited. Select a script file only. Do not select binary files (applications), and so on.

**Timeout** (1 to 9999)

Specify the maximum time to wait for completion of script to be executed. The default value is set as 5.

**Change**

Click here to display the **Change Script Editor** dialog. You can change editor for displaying or editing a script to an arbitrary editor.

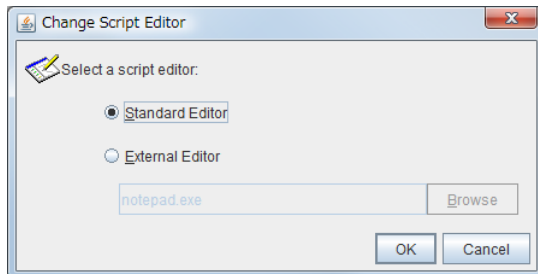

**Standard Editor**

Select this option to use the standard editor for editing scripts.

- Linux: vi (vi which is detected by the user's search path)
- Windows: Notepad (notepad.exe which is detected by the user's search path)

**External Editor**

Select this option to specify a script editor. Click **Browse** to select an editor.



To specify a CUI-based external editor on Linux, create a shell script.

The following is a sample shell script to run vi:

```
xterm -name clpedit -title " Cluster Builder " -n " Cluster Builder"
-e vi "$1"
```

## Displaying the property of the whole groups by using the WebManager

1. Start the WebManager.
2. When you click the object for the all groups  in the tree view, the following information is displayed in the list view.

Groups Name: Groups		
	server1 	server2 
Group Status		
ManagementGroup	Online	Offline
failover1	Online	Offline

Group Status: Status of each group

## Displaying the property of a certain group by using the WebManager

1. Start the WebManager.
2. When you click the object for a certain group  in the tree view, the following information is displayed in the list view.

Group Name: failover1 <span style="float: right;">Details</span>	
Properties	Value
Comment	
Status	Online
Started Server	server1
Resource Status	
disk1	Online
exec1	Online
fip1	Online

Clicking **Details** displays the popup dialog box containing the following contents:

Properties	Value
Name	failover1
Type	failover
Startup Attribute	Auto Startup
Failover Exclusive Attribute	No Exclusion
Failback Attribute	Manual Failback
Failover Attribute	Auto (The order of servers that can run the Group)
Servers that can run the Group	(1)server1 (2)server2

Name:	Group name
Type:	Group type
Startup Attribute:	Startup type of the group (auto/manual)
Failover Exclusive Attribute:	Startup exclusive attribute
Failback Attribute:	Failback attribute of the group (auto/manual)
Failover Attribute:	Failover attribute of the group (auto/manual)
Servers that can run the Group:	Order of the servers that the group failover

## Setting group resources for individual server

Some setting values of group resources can be configured for individual servers. On the properties of resources which can be set for individual servers, tabs for each server are displayed on the **Details** tab.

The following resources can be set for individual servers.

Group resource name	Supported version
Disk resource	3.0.0-1 or later
Floating IP resource	3.0.0-1 or later
Virtual IP resource	3.0.0-1 or later
Mirror disk resource	3.0.0-1 or later
Hybrid disk resource	3.0.0-1 or later
Dynamic DNS resource	3.0.0-1 or later
Virtual machine resource	3.0.0-1 or later
AWS elastic ip resource	3.3.0-1 or later
AWS virtual ip resource	3.3.0-1 or later

### Note:

Some parameters of virtual IP resources, AWS elastic IP resources, and AWS virtual IP resources should be configured for individual servers.

For parameters that can be set for individual servers, see the descriptions of parameters on each group resource. On those parameters, the **Server Individual Setup** icon is displayed.

In this example, the server individual setup for a disk resource is explained.

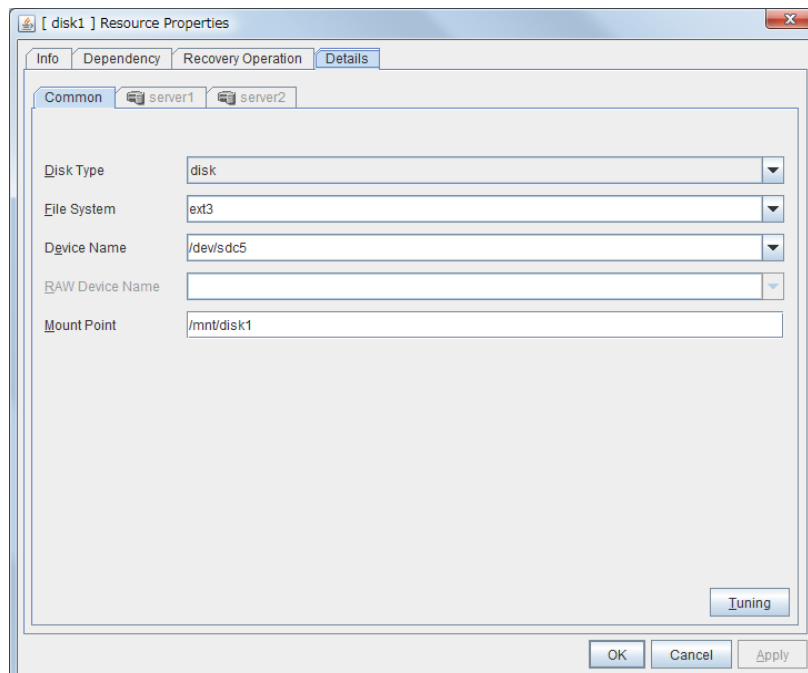

### Server Individual Setup

Parameters that can be set for individual servers on a disk resource are displayed.

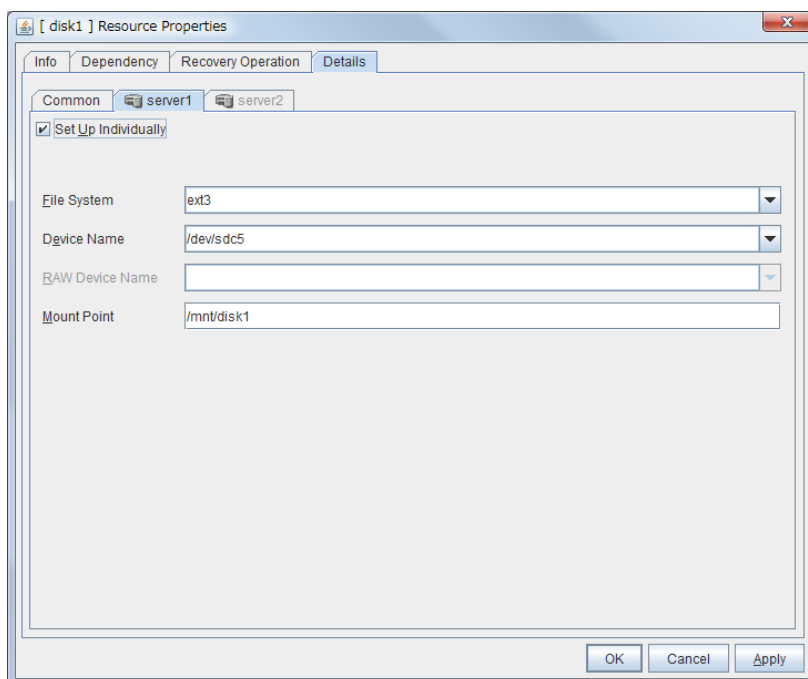

### Set Up Individually

Click the tab of the server on which you want to configure the server individual setting, and select this check box. The boxes for parameters that can be configured for individual servers become active. Enter required parameters.

---

### Note:

When setting up a server individually, you cannot select **Tuning**.

---

## Understanding server groups

This section explains about server groups.

Server groups are mainly groups of servers which are required when hybrid disk resources are used.

Upon using hybrid disk resources in a shared disk device, servers connected by the same shared disk device are configured as a server group.

Upon using hybrid disk resources in a disk which is not shared, a server is configured as a server group.

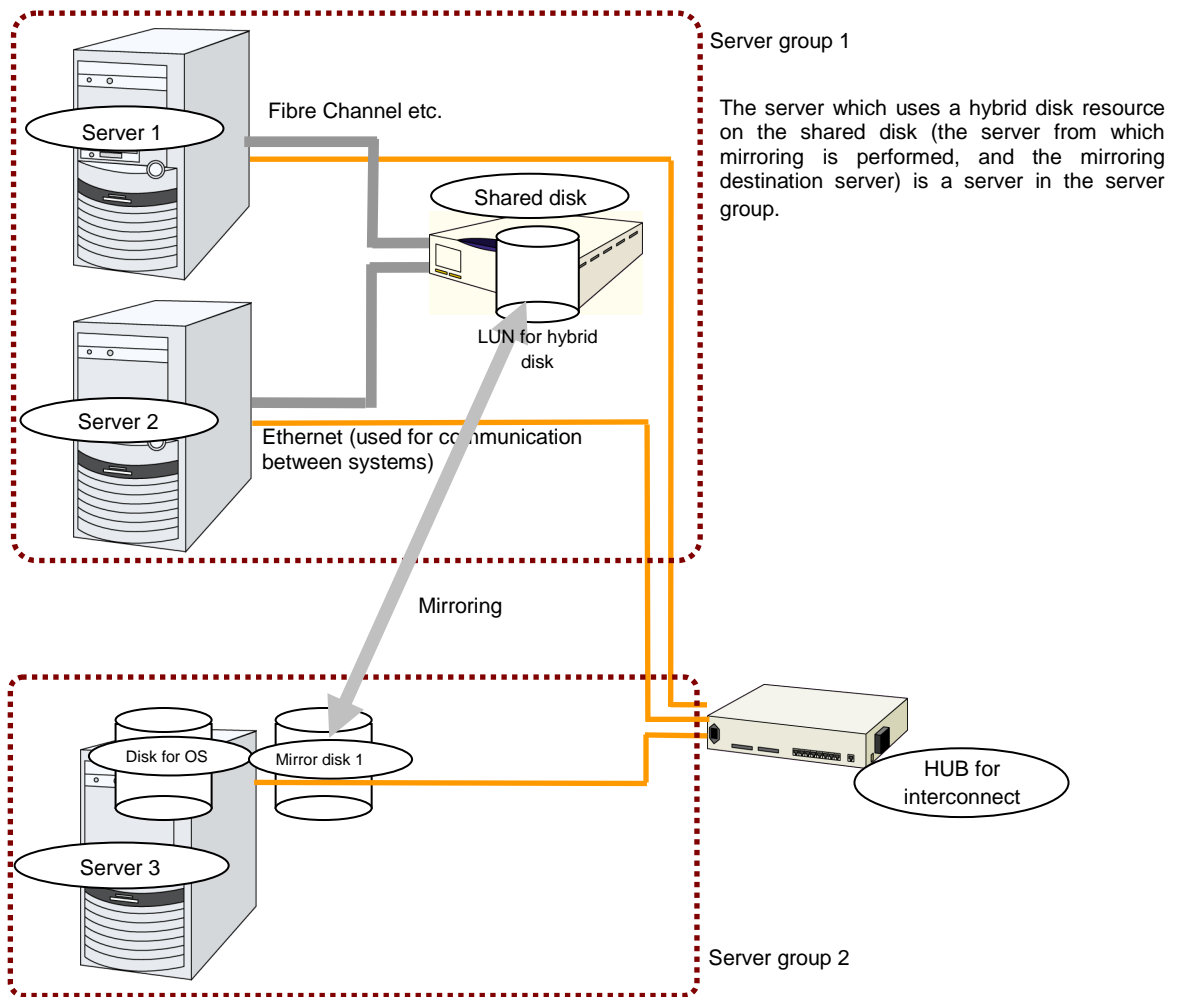

This figure omits public-LAN.



## Displaying and changing the settings of server groups

You can display and change the settings of the server group by using **Server Group Definition** of the Builder.

### Renaming a server group (Server group properties)

1. In the tree view in the left pane of the Builder, right-click the **Servers** icon, and then click **Properties**.
2. **Server Common Properties** is displayed. Click **Settings** in **Server Group**.
3. **Sever Group** is displayed. Click **Rename**.
4. The **Change Server Group Name** dialog box is displayed. Enter a new name.

### Displaying and changing the comment of a server group (Server group properties)

1. In the tree view in the left pane of the Builder, right-click the **Server** icon, and then click **Properties**.
2. **Server Common Properties** is displayed. Click **Settings** in **Server Group**.
3. **Sever Group** is displayed. Click **Properties**.
4. On the **Info** tab, the server group name and comment are displayed. Enter a new comment.

---

**Note:**

You cannot change the server group name on the **Info** tab. To change the server group name, see “Renaming a group (Group properties)” on page 591.

---

## Displaying and changing the settings of servers belonging to a server group (Server group properties)

You can change the servers which belong to a server group.

1. In the tree view in the left pane of the Builder, right-click the **Servers** icon, and then click **Properties**.
2. **Server Common Properties** is displayed. Click **Settings** in **Server Group**.
3. **Sever Group** is displayed. Click **Properties**.
4. Select the **Server Group** tab. In **Servers that can run the Group**, servers that belong to the server group and their order are shown. The smaller the number, the higher priority the server has. In **Available Servers**, the servers that can be registered with **Servers that can run the Group** are shown.

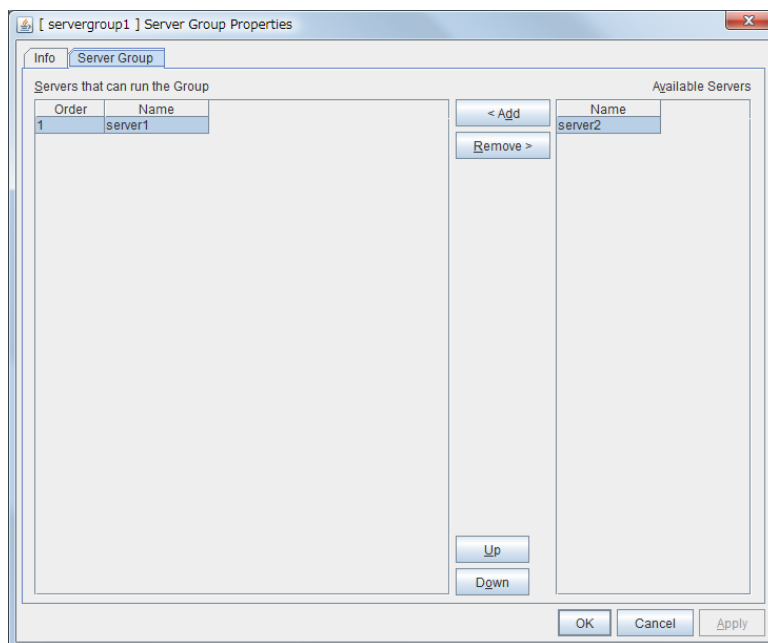

5. Configure the server group settings according to the following instruction.

### Add

Use **Add** to add a server that can run the group. Select the server you want to add from **Available Servers** list and then click **Add**. The selected server is added to the **Servers that can run the Group**.

### Remove

Use **Remove** to remove a server that can run the group. Select the server you want to remove from the **Servers that can run the Group** list and then click **Remove**. The selected server is added to **Available Servers**.

### Up & Down

Use **Up** and **Down** to change the priority of a server that can run the group. Select the server whose priority you want to change, and then click **Up** or **Down**. The selected row moves accordingly.

**Note:**

Make sure that the priority of the **Servers that can run the Group** is consistent with the failover policy of the failover group to which the resource using this server group belongs.

## Displaying the server group properties with WebManager

1. Start WebManager.
2. In the tree view, click the **Servers** object . The following will be displayed in the list view.

Servers Name: Servers		Server Group List	
	server1	server2	
Heartbeat Status			
lanhb1	Normal	Normal	
lanhb2	Normal	Normal	
lanhb1	Normal	Normal	
lanhb2	Normal	Normal	
diskhb1	Normal	Normal	
Network Partition Resolution Status			

3. Click **Server Group List**.

ServerGroup Name	Server Name
servergroup1	server1
servergroup2	server2

Server group name  
Server name

Server group name  
Server names which belong to the server group

## Understanding EXEC resources

You can register applications and shell scripts that are managed by EXPRESSCLUSTER and to be run when starting, stopping, failing over or moving groups in EXPRESSCLUSTER. It is also possible to register your own programs and shell scripts in EXEC resources. You can write codes as required for respective application because shell scripts are in the same format as an sh shell script.

---

**Note:**

The same version of the application to be run from EXEC resources must be installed on all servers in failover policy.

---

## Dependency of EXEC resources

By default, exec resources depend on the following group resource types:

Group resource type
FIP Resource
Virtual IP resource
Disk Resource
Mirror Disk Resource
Hybrid Disk Resource
NAS Resource
VM Resource
Volume Manager Resource
Dynamic DNS Resource
AWS elastic ip resource
AWS virtual ip resource
Azure probe port resource

## Method of judging EXEC resource activation/deactivation results

The activation/deactivation results are judged based on the results of executing the applications and shell scripts registered in the EXEC resources.

If the end code of an application or a shell script is 0, it is judged that activation/deactivation was performed normally and successfully.

If the end code is other than 0, it is judged that activation/deactivation has failed.

If a start/stop script timeout occurs, it is judged that activation/deactivation has failed.

## Scripts in EXEC resources

### Types of scripts

Start script and stop script are provided in EXEC resources. EXPRESSCLUSTER runs a script for each EXEC resource when the cluster needs to change its status. You have to write procedures in these scripts about how you want applications to be started, stopped, and restored in your cluster environment.

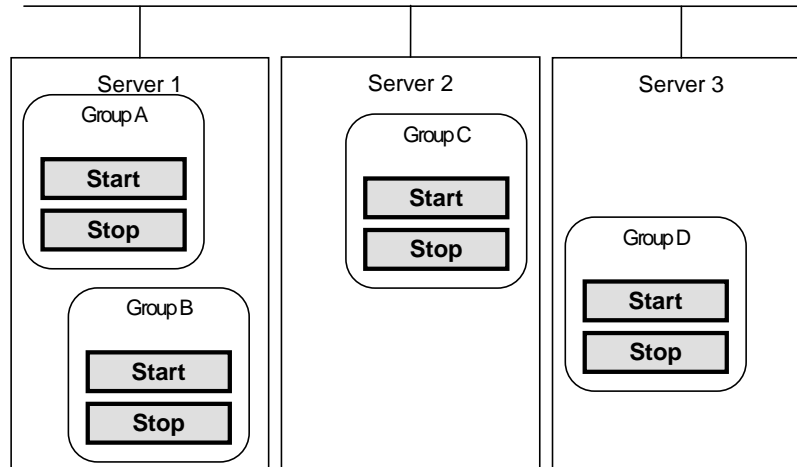

Start: Start script  
Stop: Stop script

## Environment variables in EXEC resource script

When EXPRESSCLUSTER runs a script, it records information such as condition when the script was run (script starting factor) in environment variables.

You can use the environment variables in the table below as branching condition when you write codes for your system operation.

Stop script returns the contents of the previous start script in the environment variable as a value. Start script does not set environment variables of CLP\_FACTOR and CLP\_PID.

The environment variable CLP\_LASTACTION is set only when the environment variable CLP\_FACTOR is CLUSTERSHUTDOWN or SERVERSHUTDOWN.

Environment Variable	Value of environment variable	Meaning
CLP_EVENT ...script starting factor	START	The script was run: - by starting a cluster; - by starting a group; - on the destination server by moving a group; - on the same server by restarting a group due to the detection of a monitor resource error; or - on the same server by restarting a group resource due to the detection of a monitor resource error.
	FAILOVER	The script was run on the failover target server: - by the failure of the server; - due to the detection of a monitor resource error; or - because activation of group resources failed.
CLP_FACTOR ...group stopping factor	CLUSTERSHUTDOWN	The group was stopped by stopping the cluster.
	SERVERSHUTDOWN	The group was stopped by stopping the server.
	GROUPSTOP	The group was stopped by stopping the group.
	GROUPMOVE	The group was moved by moving the group.
	GROUPFAILOVER	The group failed over because an error was detected in monitor resource; or the group failed over because of activation failure in group resources.
	GROUPRESTART	The group was restarted because an error was detected in monitor resource.
	RESOURCERestart	The group resource was restarted because an error was detected in monitor resource.

Environment Variable	Value of environment variable	Meaning
CLP_LASTACTION ...process after cluster shutdown	REBOOT	In case of rebooting OS
	HALT	In case of halting OS
	NONE	No action was taken.
CLP_SERVER ...server where the script was run	HOME	The script was run on the primary server of the group.
	OTHER	The script was run on a server other than the primary server of the group.
CLP_DISK <sup>1</sup> ...partition connection information on shared or mirror disks	SUCCESS	There was no partition where connection had failed.
	FAILURE	There was one or more partition where connection had failed.
CLP_PRIORITY ... the order in failover policy of the server where the script is run	1 to the number of servers in the cluster	Represents the priority of the server where the script is run. This number starts from 1 (The smaller the number, the higher the server's priority).  If CLP_PRIORITY is 1, it means that the script is run on the primary server.
CLP_GROUPNAME ...Group name	Group name	Represents the group name that the script belongs.
CLP_RESOURCENAME ...Resource name	Resource name	Represents the resource name that the script belongs.
CLP_PID ...Process ID	Process ID	Represents the process ID of start script when the property of start script is set to asynchronous. This environment variable is null when the start script is set to synchronous.
CLP_VERSION_FULL ...EXPRESSCLUSTER full version	EXPRESSCLUSTER full version	Represents the EXPRESSCLUSTER full version.  (Example) 3.3.0-1
CLP_VERSION_MAJOR ...EXPRESSCLUSTER major version	EXPRESSCLUSTER major version	Represents the EXPRESSCLUSTER major version.  (Example) 3
CLP_PATH ...EXPRESSCLUSTER install path	EXPRESSCLUSTER install path	Represents the path where EXPRESSCLUSTER is installed.  (Example) /opt/nec/clusterpro
CLP_OSNAME ...Server OS name	Server OS name	Represents the OS name of the server where the script was executed.  (Example)  (1) When the OS name could be acquired:  Red Hat Enterprise Linux Server release 6.0 (Santiago)  (2) When the OS name could not be acquired:  Linux

<sup>1</sup> It is available for disk resource, mirror disk resource, hybrid disk resource, NAS resource and volume manager resource.

Environment Variable	Value of environment variable	Meaning
CLP_OSVER ...Server OS version	Server OS version	Represents the OS version of the server where the script was executed. (Example) (1) When the OS version could be acquired: 6.0 (2) When the OS version could not be acquired: *Blank



## Execution timing of EXEC resource script

This section describes the relationships between the execution timings of start and stop scripts and environment variables according to cluster status transition diagram.

- ◆ To simplify the explanations, 2-server cluster configuration is used as an example. See the supplements for the relations between possible execution timings and environment variables in 3 or more server configurations.
- ◆ O and X in the diagrams represent the server status.

Server	Server status
O	Normal (properly working as a cluster)
X	Stopped (cluster is stopped)

(Example) OA: Group A is working on a normally running server.

- ◆ Each group is started on the top priority server among active servers.
- ◆ Three Group A, B and C are defined in the cluster, and they have their own failover policies as follows:

Group	1 <sup>st</sup> priority server	2 <sup>nd</sup> priority server
A	server1	server2
B	server2	server1
C	server1	server2

- ◆ The upper server is referred to as server1 and the lower one as server2.

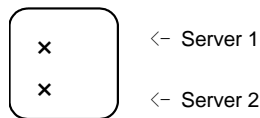

<Cluster status transition diagram>

This diagram illustrates a typical status transition of cluster.

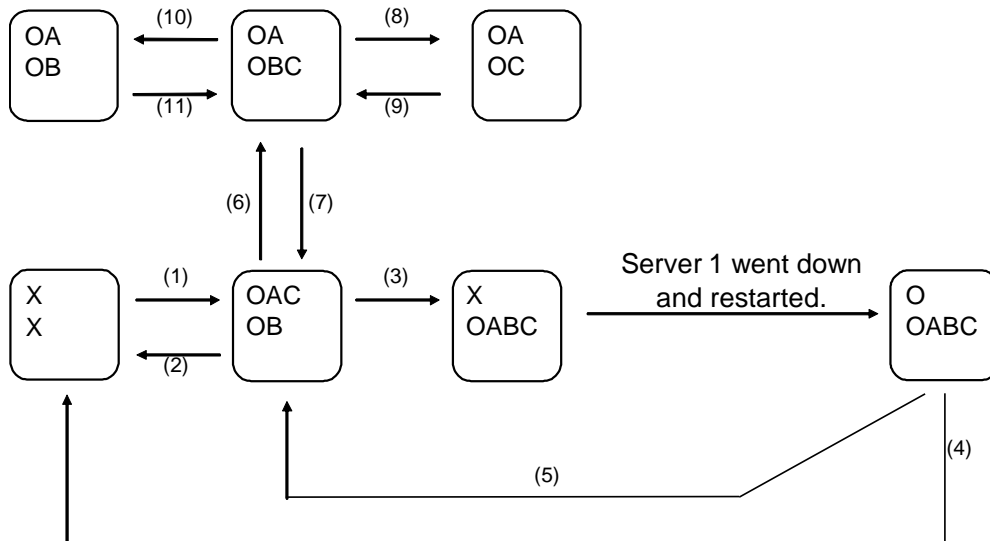

Numbers (1) to (11) in the diagram correspond to descriptions as follows.

**(1) Normal startup**

Normal startup here means that the start script has been run properly on the primary server.

Each group is started on the server with the highest priority among the active servers.

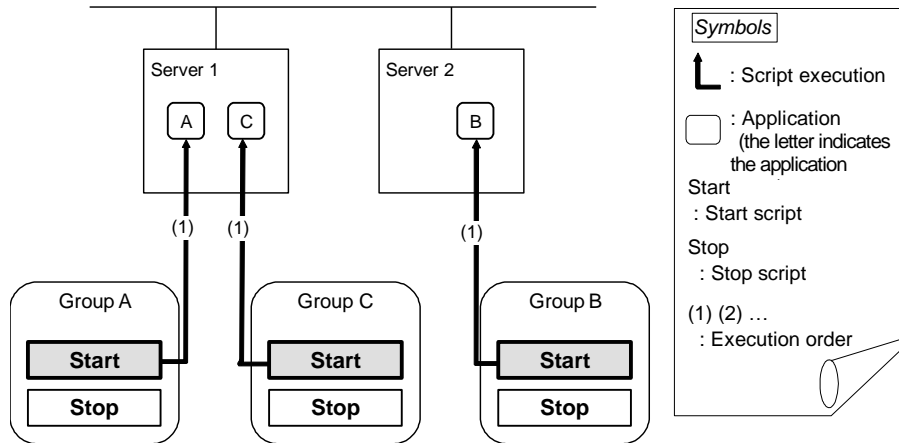

Environment variables for Start

Group	Environment variable	Value
A	CLP_EVENT	START
	CLP_SERVER	HOME
B	CLP_EVENT	START
	CLP_SERVER	HOME
C	CLP_EVENT	START
	CLP_SERVER	HOME

**(2) Normal shutdown**

Normal shutdown here means a cluster shutdown immediately after the start script corresponding to the stop script that was run by performing normal startup or by moving a group (online failback).

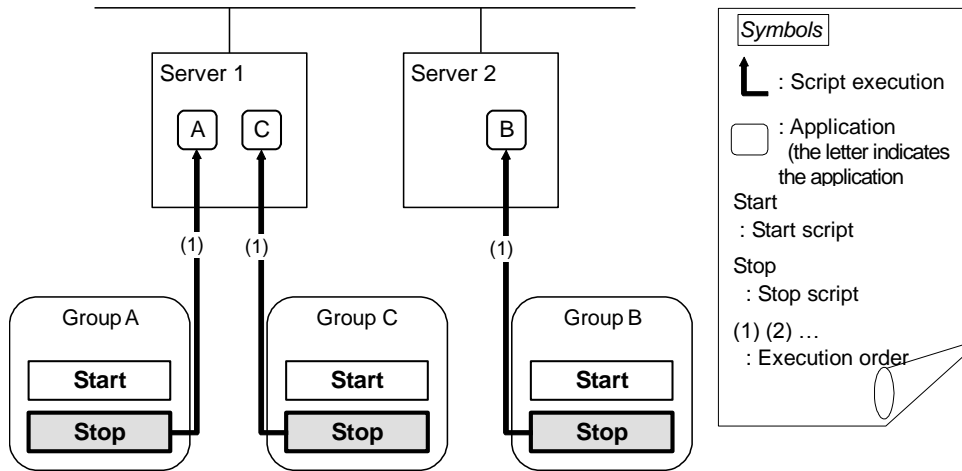

Environment variables for Stop

Group	Environment variable	Value
A	CLP_EVENT	START
	CLP_SERVER	HOME
B	CLP_EVENT	START
	CLP_SERVER	HOME
C	CLP_EVENT	START
	CLP_SERVER	HOME

**(3) Failover at server1 down**

When the start scrip of a group which has server1 as its primary server, it is run on a lower priority server (server2) when an error occurs. You need to write CLP\_EVENT(=FAILOVER) as a branching condition for triggering application startup and recovery processes (such as database rollback process) in the start script in advance.

For the process to be performed only on a server other than the primary server, specify CLP\_SERVER(=OTHER) as a branching condition and describe the process in the script.

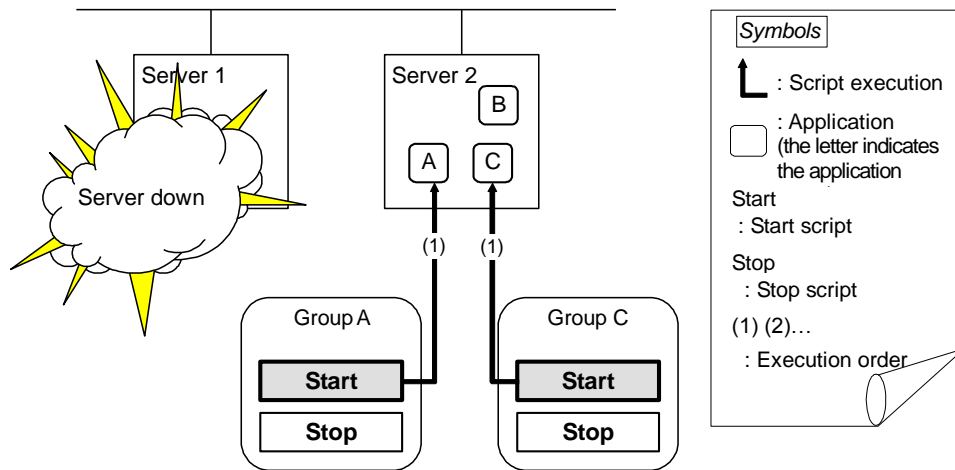

Environment variables for Start

Group	Environment variable	Value
A	CLP_EVENT	FAILOVER
	CLP_SERVER	OTHER
C	CLP_EVENT	FAILOVER
	CLP_SERVER	OTHER

**(4) Cluster shutdown after failover of server1**

The stop scripts of the Group A and C are run on server2 where the groups fail over (the stop script of Group B is run by a normal shutdown).

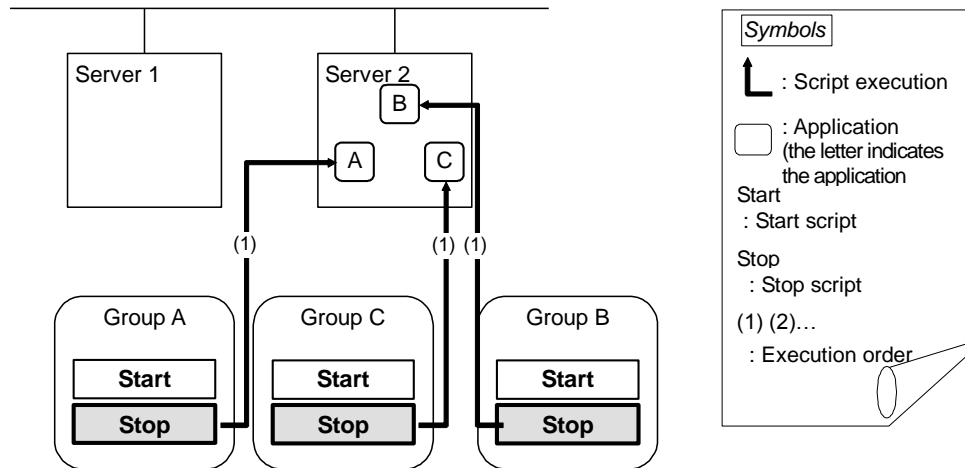

Environment variables for Stop

Group	Environment variable	Value
A	CLP_EVENT	FAILOVER
	CLP_SERVER	OTHER
B	CLP_EVENT	START
	CLP_SERVER	HOME
C	CLP_EVENT	FAILOVER
	CLP_SERVER	OTHER

**(5) Moving of Group A and C**

After the stop scripts of Group A and C are run on server2 where the groups fail over, their start scripts are run on server1.

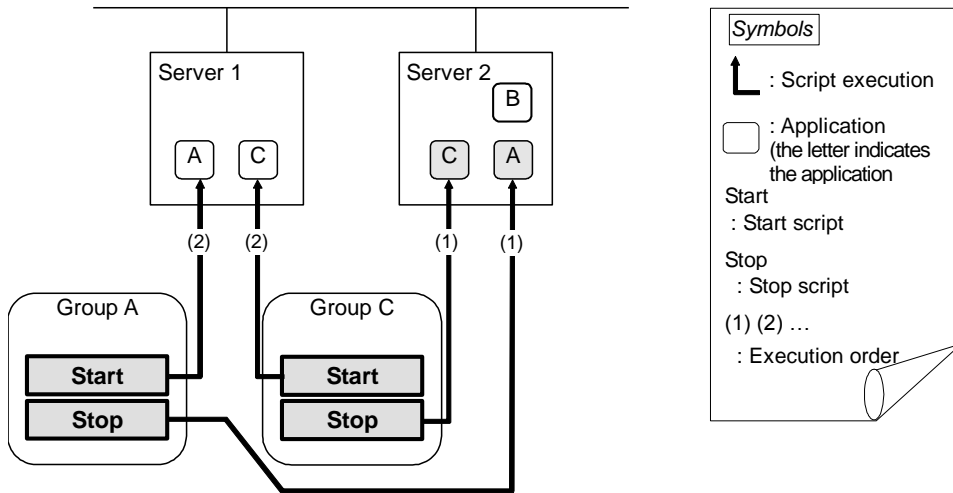

Environment variables for Stop

Group	Environment variable	Value
A	CLP_EVENT	FAILOVER <sup>2</sup>
	CLP_SERVER	OTHER
C	CLP_EVENT	FAILOVER
	CLP_SERVER	OTHER

Environment variables for Start

Group	Environment variable	Value
A	CLP_EVENT	START
	CLP_SERVER	HOME
C	CLP_EVENT	START
	CLP_SERVER	HOME

<sup>2</sup> Environment variables in a stop script take those in the previous start script.

For moving in “(5) Moving of Group A and C” because it is not preceded by a cluster shutdown, the environment variable used here is FAILOVER. However, if a cluster shutdown is executed before moving in “(5) Moving of Group A and C,” the environment variable is START.

**(6) Error in Group C and failover**

When an error occurs in Group C, its stop script is run on server1 and start script is run on server2.

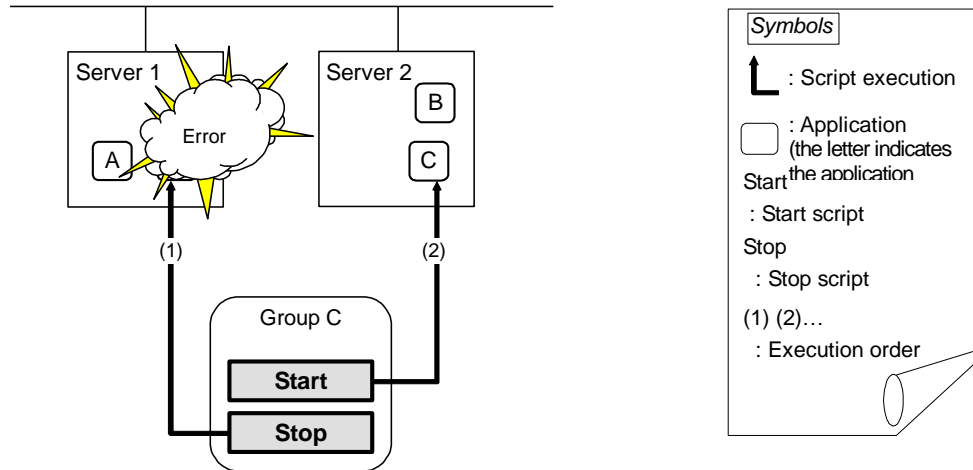

Stop for server1

Group	Environment variable	Value
C	CLP_EVENT	START
	CLP_SERVER	HOME

Start for server2

Group	Environment variable	Value
C	CLP_EVENT	FAILOVER
	CLP_SERVER	OTHER

**(7) Moving of Group C**

Move the Group C that is failed over to server2 in (6) from server2 to server1. Run the stop script on server2, and then run the start script on server1.

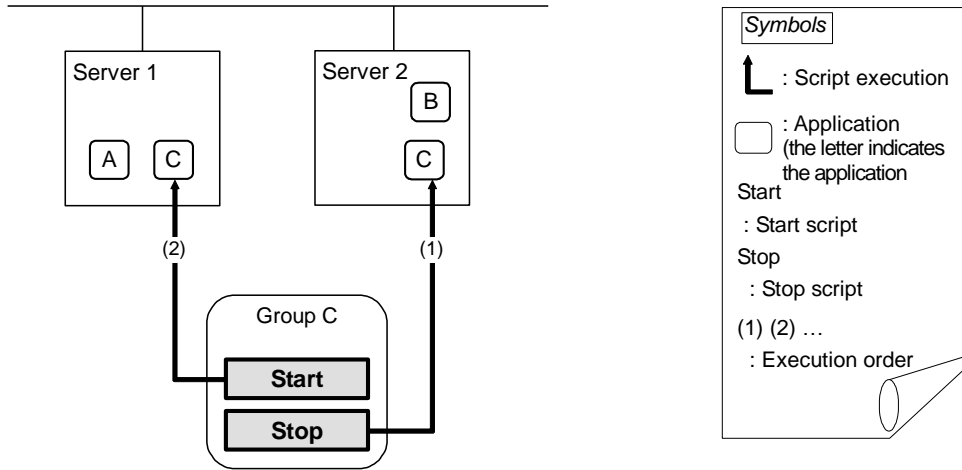

Stop (because this is failed over in (6))

Group	Environment variable	Value
C	CLP_EVENT	FAILOVER
	CLP_SERVER	OTHER

Start

Group	Environment variable	Value
C	CLP_EVENT	START
	CLP_SERVER	HOME



**(8) Stopping Group B**

The stop script of Group B is run on server2.

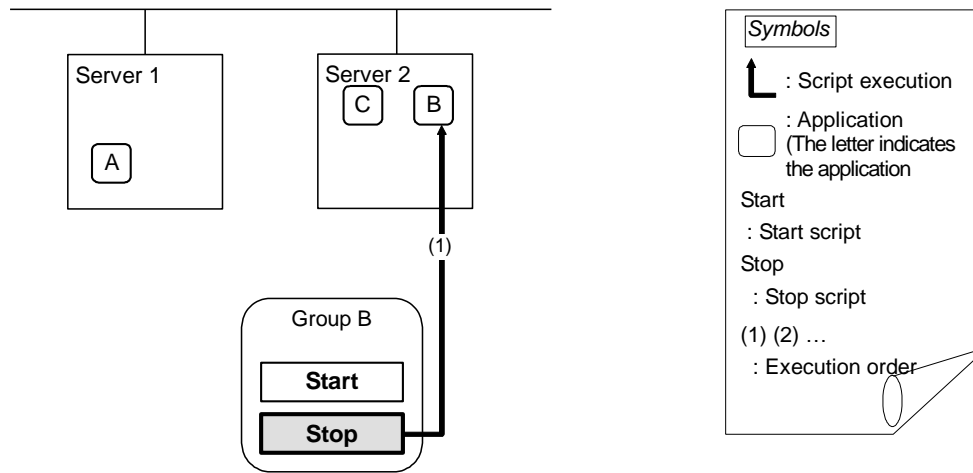

Stop

Group	Environment variable	Value
B	CLP_EVENT	START
	CLP_SERVER	HOME

**(9) Starting Group B**

The start script of Group B is run on server2.

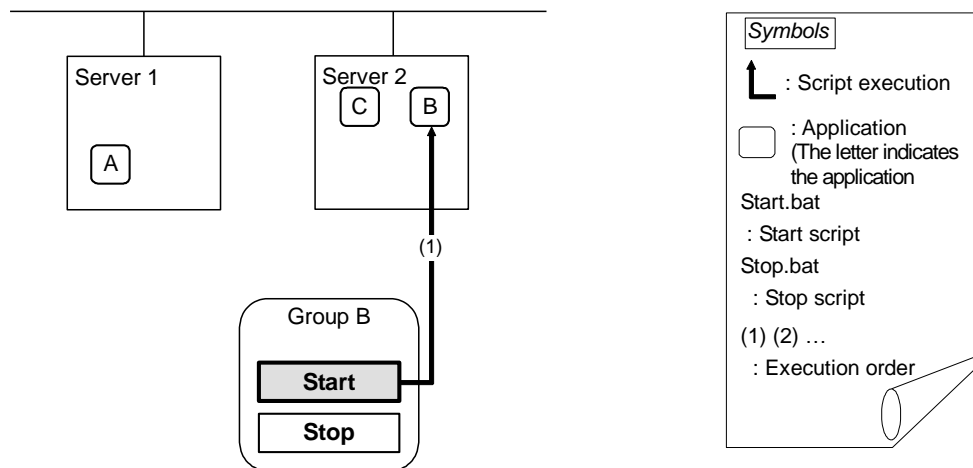

Start

Group	Environment variable	Value
B	CLP_EVENT	START
	CLP_SERVER	HOME

**(10) Stopping Group C**

The stop script of Group C is run on server2.

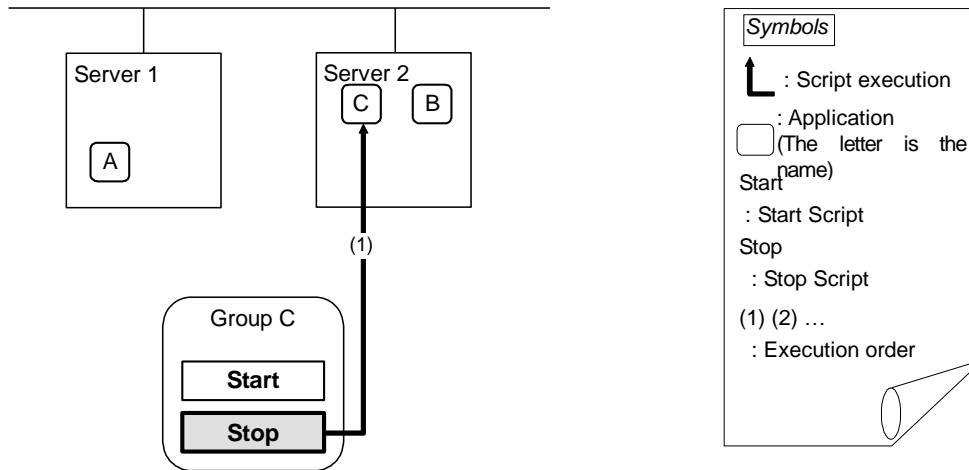

Stop

Group	Environment variable	Value
C	CLP_EVENT	FAILOVER
	CLP_SERVER	OTHER

**(11) Starting Group C**

The start scrip of Group C is run on server2.

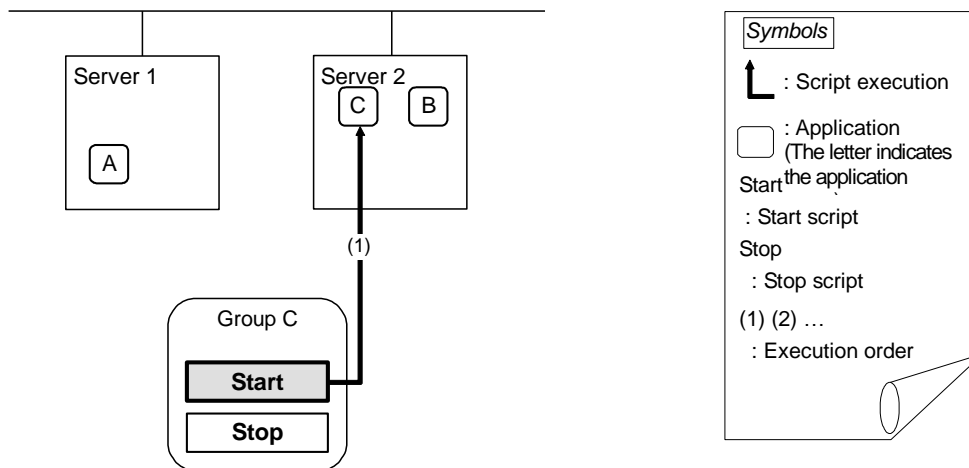

Start

Group	Environment variable	Value
C	CLP_EVENT	START
	CLP_SERVER	OTHER

**Supplementary information 1**

For a group that has three or more servers specified in the failover policy to behave differently on servers other than the primary server, use CLP\_PRIORITY instead of CLP\_SERVER(HOME/OTHER).

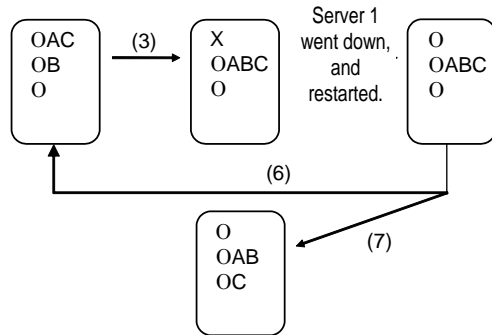

Example 1: “(3) Failover at server1 down” in the cluster status transition diagram

A group has server1 as its primary server. If an error occurs on server1, its start script is run on server2 that has next highest priority failover policy. You need to write CLP\_EVENT(=FAILOVER) as the branching condition for triggering applications’ startup and recovery processes (such as database rollback process) in the start script in advance.

For a process to be performed only on the server that has the second highest priority failover policy, it is necessary to write CLP\_PRIORITY(=2) as the branching condition.

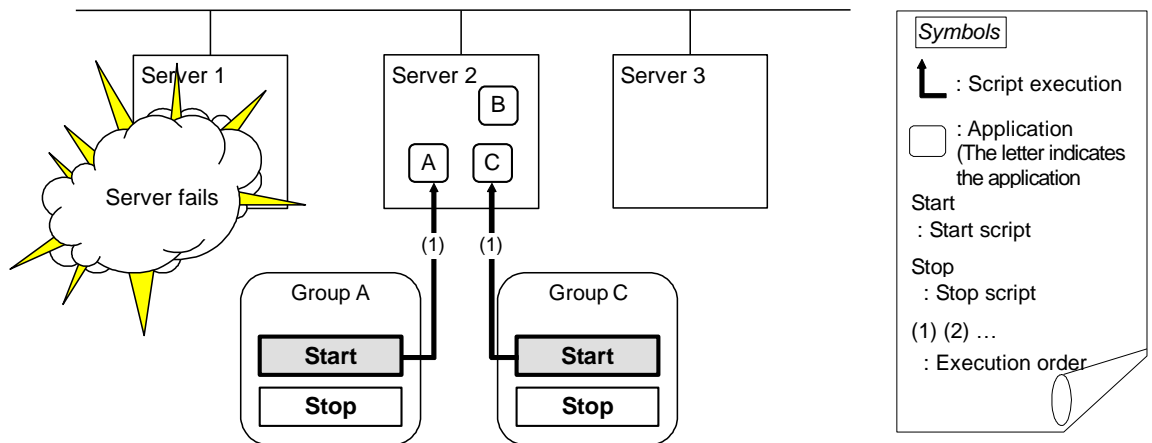

Environment variables for Start

Group	Environment variable	Value
A	CLP_EVENT	FAILOVER
	CLP_SERVER	OTHER
	CLP_PRIORITY	2
C	CLP_EVENT	FAILOVER
	CLP_SERVER	OTHER
	CLP_PRIORITY	2

Example 2: “(7) Moving of Group C” in the cluster status transition diagram

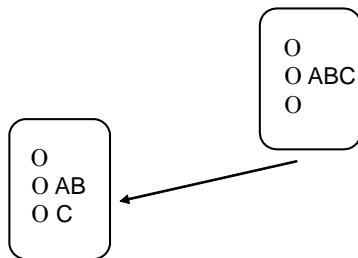

After the stop scrip of Group C is run on server2 where the group failed over from, the start script is run on server3.

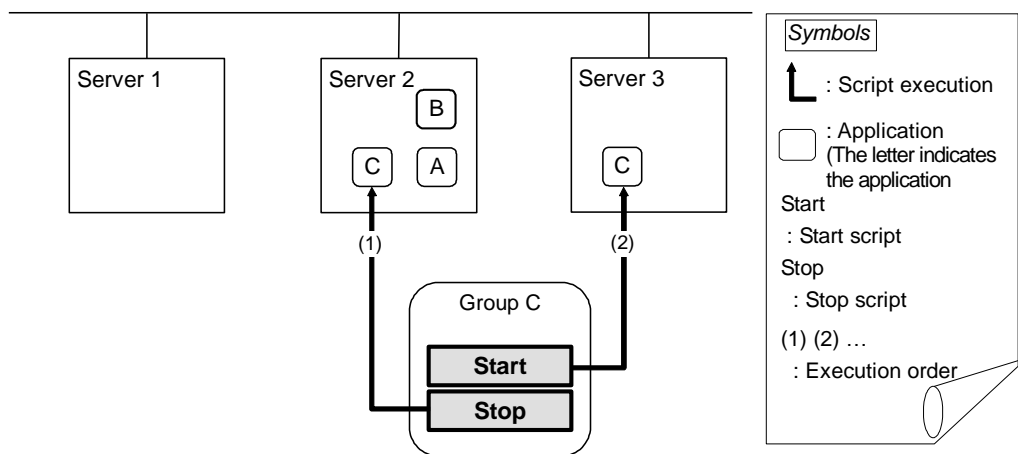

Environment variables for Stop

Group	Environment variable	Value
C	CLP_EVENT	FAILOVER
	CLP_SERVER	OTHER
	CLP_PRIORITY	2

Environment variables for Start

Group	Environment variable	Value
C	CLP_EVENT	START
	CLP_SERVER	OTHER
	CLP_PRIORITY	3

**Supplementary information 2**

When monitor resource starts or restarts a script:

To run the start script when resource monitor detected an error in application, the environment variables should be as follows:

Example 1: Resource monitor detects abnormal termination of an application that was running on server1 and restarts Group A on the server1.

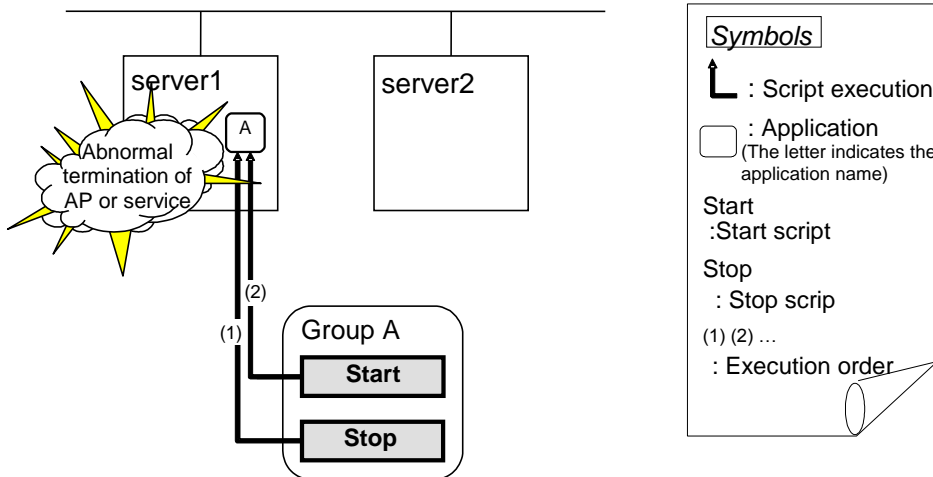

Environment variable for Stop

Group		Environment variable	Value
A	(1)	CLP_EVENT	The same value as when the start script is run

Environment variable for Start

Group		Environment variable	Value
A	(2)	CLP_EVENT	START

Example2: Resource monitor detects abnormal termination of an application that was running on server1, fails over to server2 and restarts Group A on server2

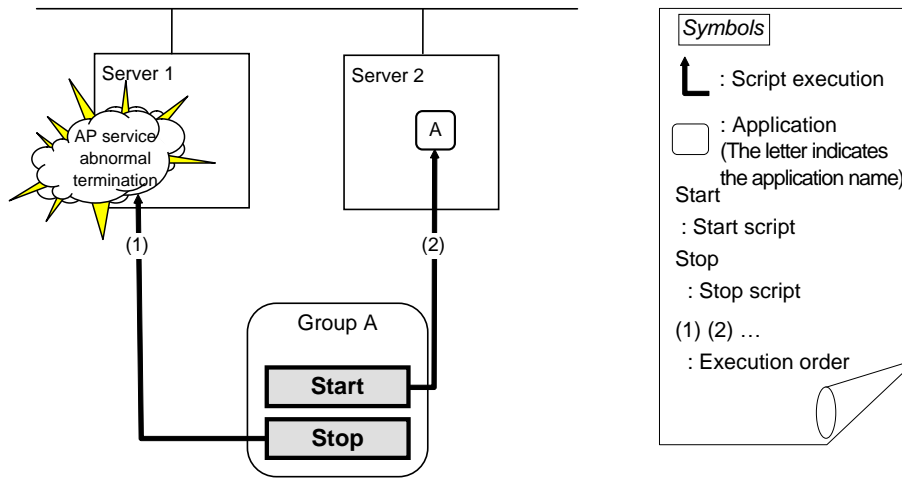

Environment variable for Stop

Group		Environment variable	Value
A	(1)	CLP_EVENT	The same value as when the start script is run

Environment variable for Start

Group		Environment variable	Value
A	(2)	CLP_EVENT	FAILOVER

## Writing EXEC resource scripts

This section explains timing script execution described in the preceding topic relating to the actual script codes.

Numbers in brackets “(*number*)” in the following example script code represent the actions described in “Execution timing of EXEC resource script” on page 629.

Group A start script: A sample of **start.sh**

```

#!/bin/sh
# *****
# *           start.sh           *
# *****

if [ "$CLP_EVENT" = "START" ]
then
    if [ "$CLP_DISK" = "SUCCESS" ]
    then
        

Refer to the environment variable of
            script executing factor and divide the
            processes.



Overview of processing:
            Application's normal startup processing
            When to start this process:
            (1) Normal startup
            (5) Moving of Group A and C

        if [ "$CLP_SERVER" = "HOME" ]
        then
            

Refer to the environment variable of
                executing server and divide the
                processes.



Overview of processing:
                A process to be executed only when the application is normally started on the primary
                server.
                When to start this process:
                (1) Normal startup
                (5) Moving of Group A and C

        else
            

Overview of processing:
                A process to be executed only when the application is normally started on the server other
                than the primary server.
                When to start this process:



        fi
    else
        

Disk-related error handling

    fi
fi

elif [ "$CLP_EVENT" = "FAILOVER" ]
then

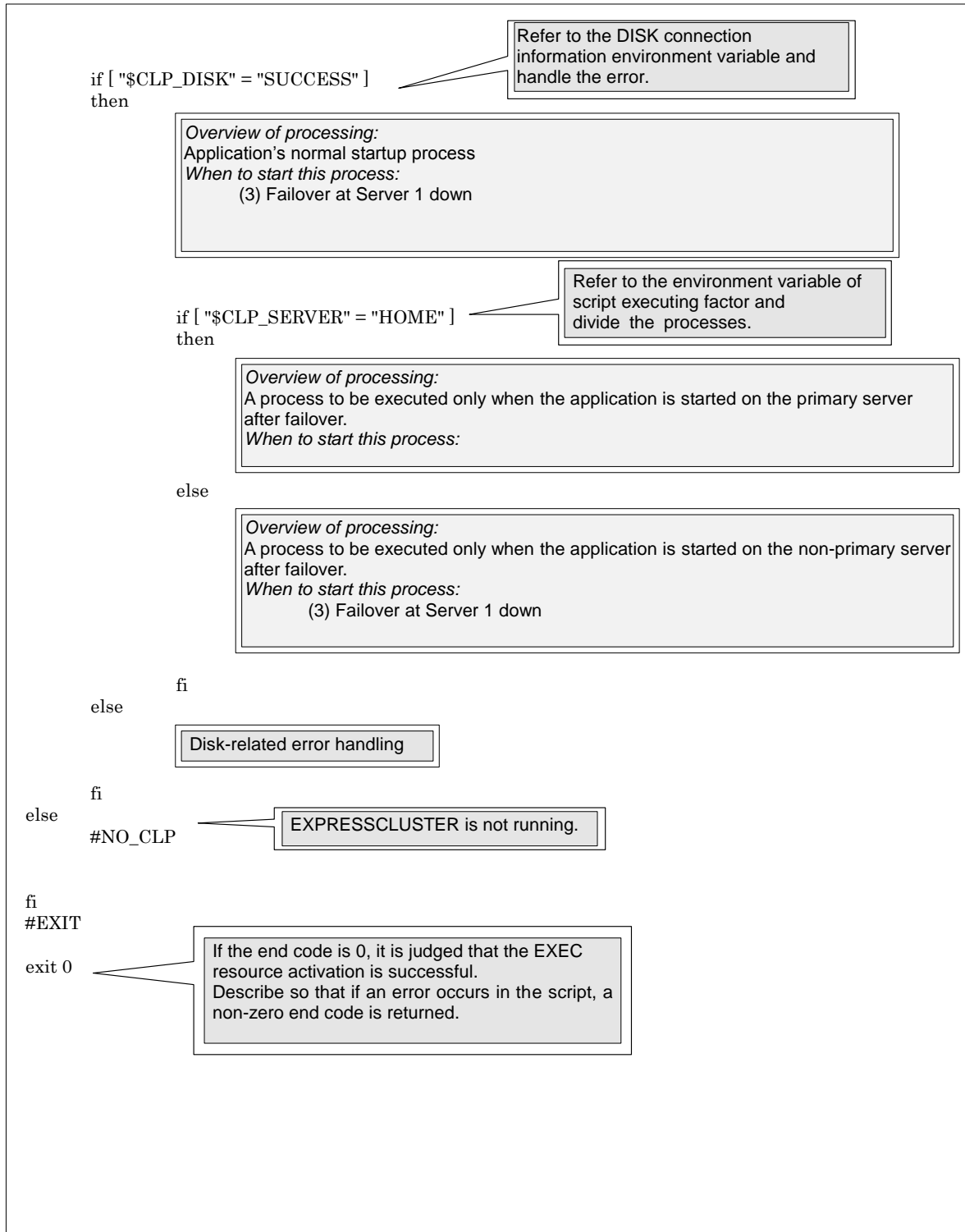
```





Group A stop script: A sample of **stop.sh**

```

#!/bin/sh
# *****
# *           stop.sh           *
# *****

if [ "$CLP_EVENT" = "START" ]
then
    if [ "$CLP_DISK" = "SUCCESS" ]
    then
        

Refer to the environment variable of
            script executing factor and divide the
            processes.



Overview of processing:
            Application's normal startup process
            When to start this process:
            (2) Normal shutdown

    fi

    if [ "$CLP_SERVER" = "HOME" ]
    then
        

Refer to the environment variable of
            executing server and divide the
            processes.



Overview of processing:
            A process to be executed only when the application is normally terminated on the primary
            server.
            When to start this process:
            (2) Normal shutdown

    else
        

Overview of processing:
            A process to be executed only when the application is normally terminated on the server
            other than the primary server.
            When to start this process:

    fi

    else
        

Disk-related error handling

    fi

    fi

elif [ "$CLP_EVENT" = "FAILOVER" ]
then

```

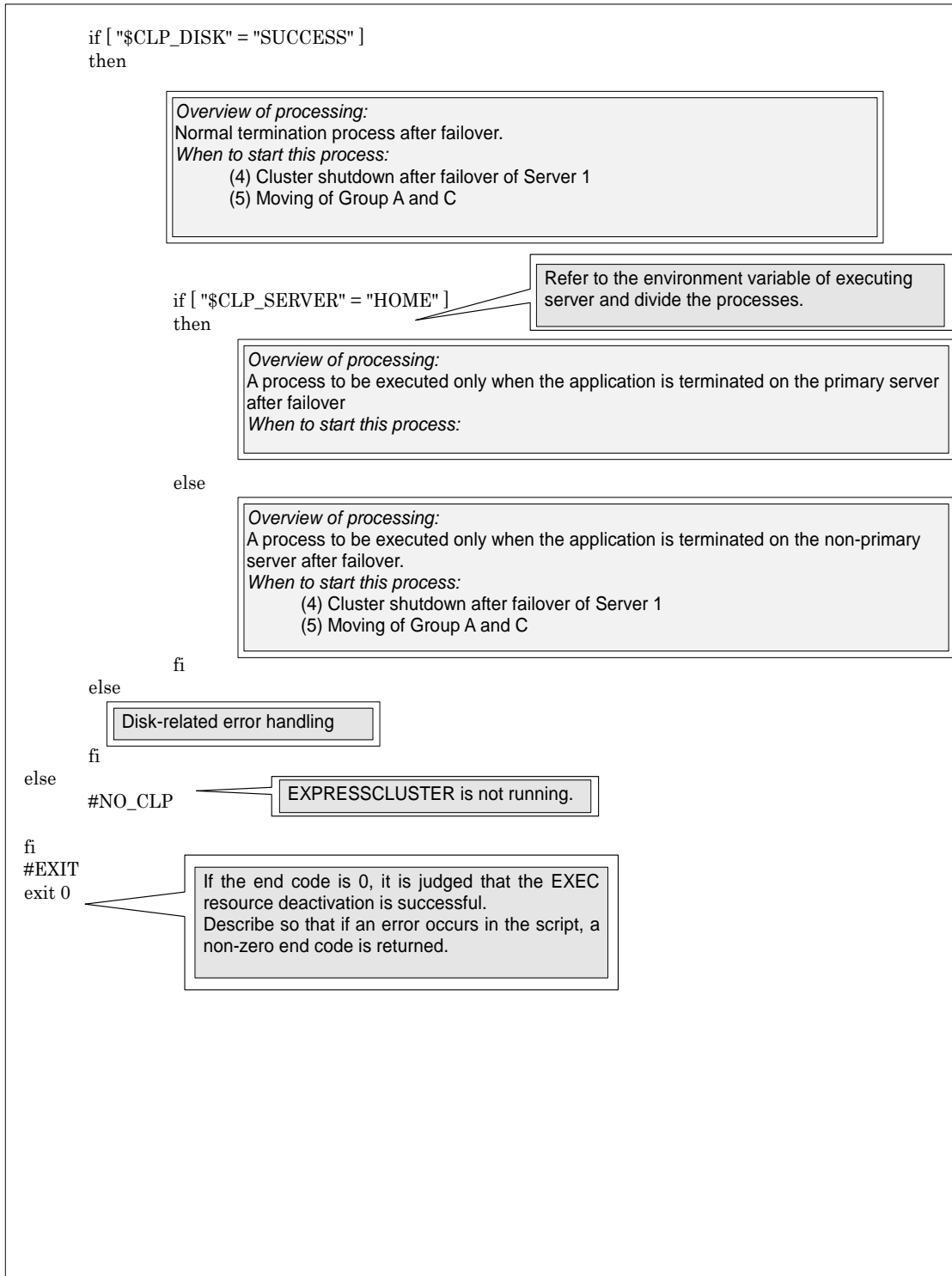

## Tips for creating EXEC resource script

- ◆ If your script has a command that requires some time to complete, it is recommended to configure command completion messages to be always produced. This message can be used to determine the error when a problem occurs. There are two ways to produce the message:
- ◆ Specify the log output path of EXEC resource by writing the echo command in the script.

The message can be produced with the echo command. Specify the log output path in the resource properties that contain the script.

The message is not logged by default. For how to configure the settings for the log output path, see “Tuning EXEC resource” on page 656. If the **Rotate Log** check box is not selected, pay attention to the available disk space of a file system because messages are sent to the file specified as the log output destination file regardless of the size of available disk space.

(Example: sample script)

```
echo "appstart.."  
appstart  
echo "OK"
```

Write the `clplogcmd` command in the script.

The message can be produced to the alert view of the WebManager or syslog in OS with the `clplogcmd` command. For details on the `clplogcmd` command, see “Outputting messages (clplogcmd command)” in Chapter 3, “EXPRESSCLUSTER command reference” in this guide.

(Example: sample script)

```
clplogcmd -m "appstart.."  
appstart  
clplogcmd -m "OK"
```

## Notes on EXEC Resource

- ◆ Script Log Rotate

When Script Log Rotate is enabled, the logs are written to the specified file after the script finishes. If the start script is set to **Asynchronous**, the script does not finish and the logs are not written. Therefore, it is recommended that you disable Script Log Rotate. If the start script is set to **Synchronous**, redirect the standard output of the resident process started in the start script to /dev/null.

- ◆ The start script and the stop script are executed by the root user.

- ◆ To start an application dependent on an environment variable, the script must set the environment variable as needed.

## Displaying and changing the EXEC resource details

1. In the tree view shown on the left pane of the Builder, click the icon of the group to which the EXEC resource whose detailed information you want to display and change belongs.
2. The list of group resources is displayed in the table view on the right pane of the screen. Right-click the name of EXEC resource that you want to display and change. Click **Properties**, and then click **Details** tab.
3. Display and/or change the settings by following the description below.

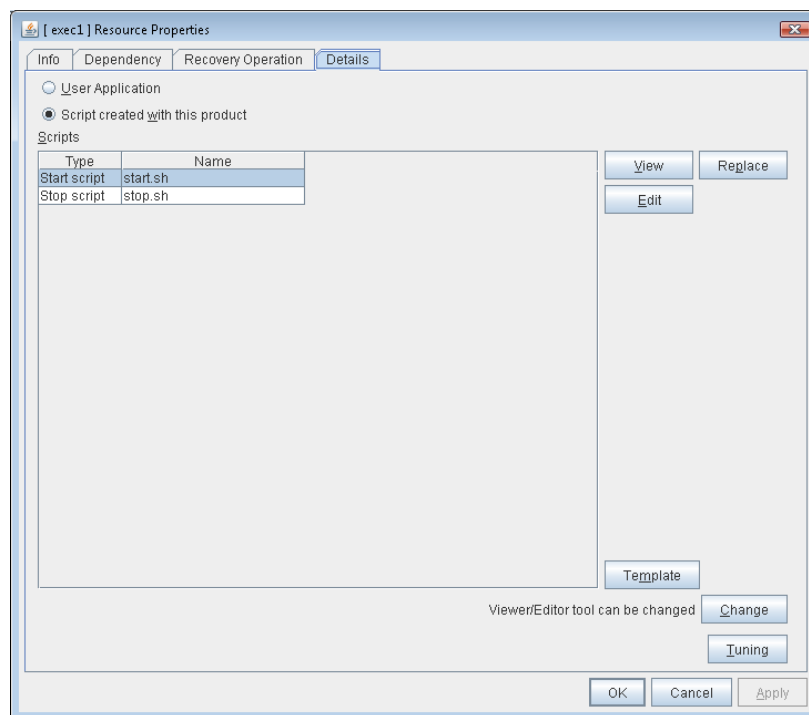

### User Application

Select this option to use executable files (executable shell scripts and binary files) on your server as scripts. Specify the local disk path on the server for each executable file name.

The executable files will not be distributed to each server. They should be placed on each server in advance. The cluster configuration data created by the Builder does not contain these files. You cannot edit the script files using the Builder.

### Script created with this product

Select this option to use script files created by the Builder as scripts. You can edit them using the Builder as necessary. The cluster configuration data contains these script files.

**Change**

Opens a dialog box for changing script editor. You can change the script editor for viewing and editing scripts to any editor.

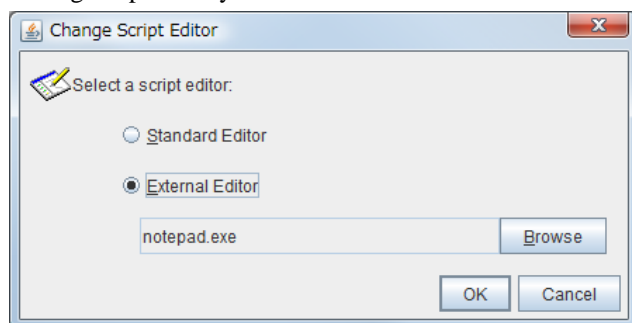
**Standard Editor**

Select this option to use the standard editor for editing scripts.

- Linux: vi (vi which is detected by the user's search path)
- Windows: Notepad (notepad.exe which is detected by the user's search path)

**External Editor**

Select this option to specify a script editor. Click **Browse** to select an editor.

To specify a CUI-based external editor on Linux, create a shell script.

The following is a sample shell script to run vi:

```
xterm -name clpedit -title "Cluster Builder" -n "Cluster Builder"
-e vi "$1"
```

**Tuning**

Opens the EXEC resource tuning properties dialog box. You can make advanced settings for the EXEC resource. If you want the PID monitor resource to monitor the exec resources, you have to set the start script to asynchronous.

## Displaying and changing the EXEC resource script created by the Builder

1. From the tree view in the left pane of the Builder, click the icon of the group to which EXEC resource whose detail information you want to display and change belongs.
2. Group resource list is displayed on the table view in the right pane of the window. Right-click the EXEC resource name. Then click **Properties** and select the **Details** tab.
3. Click **Script Created by the Builder** in the **Details** tab.
4. The settings of monitor resource can be displayed and/or changed by following the description below.

The default script file names, start.sh and stop.sh, are listed on **Scripts**.

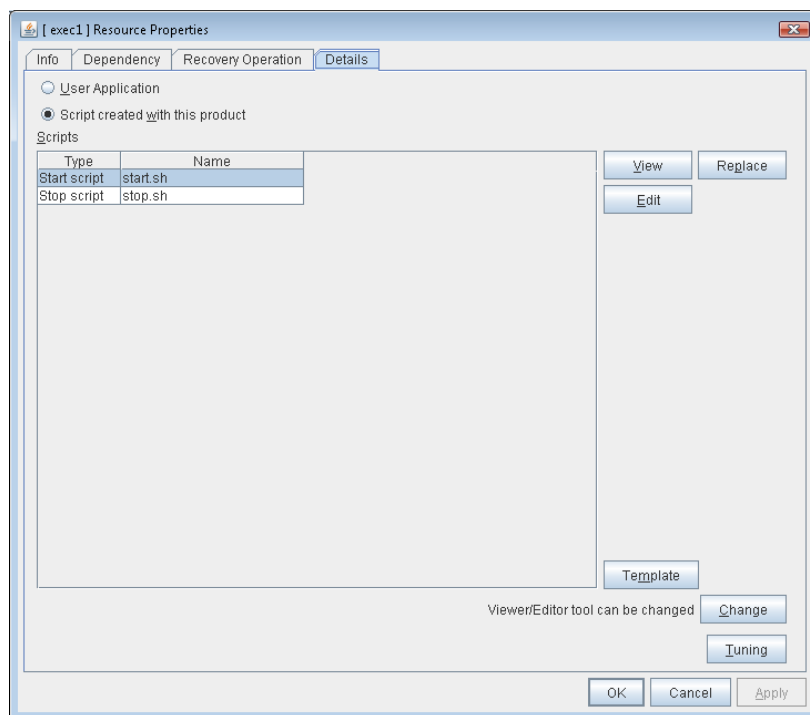

### View

Displays the selected script file on the script editor.<sup>3</sup> Changes made and saved by the editor are not applied.

If the selected script file is being viewed or edited, you cannot see it.

### Edit

You can edit the selected script file on the script editor. To apply changes, overwrite the file. If the selected script file is being viewed or edited, you cannot edit it. You cannot rename the script file

<sup>3</sup> In the Linux environment, the default script editor is vi. Use the q command to close the editor.

### Replace

Opens the **Open** dialog box.

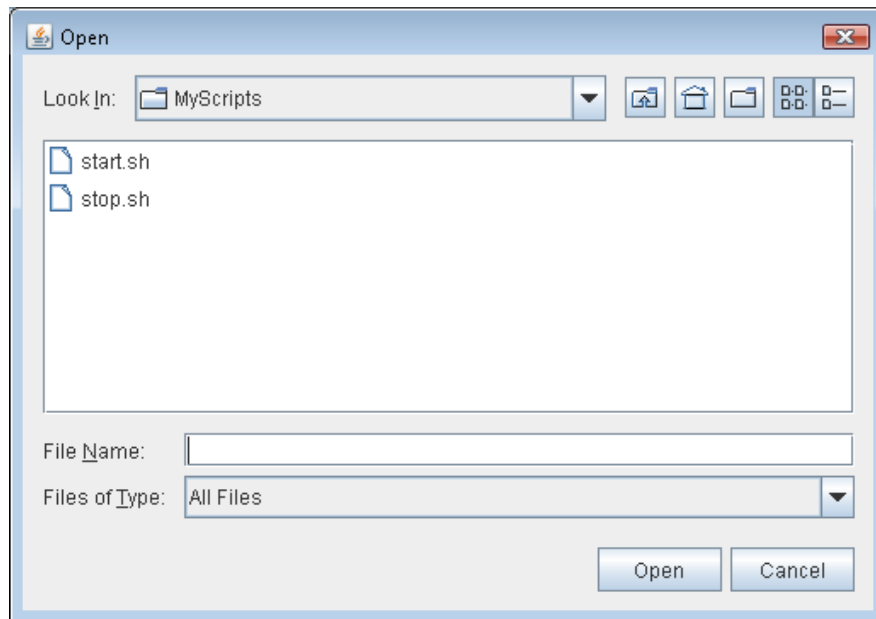

The contents of the script file selected in the **Resource Property** are replaced with the one selected in the **Open** dialog box. If the selected script file is being viewed or edited, you cannot replace it. Select a script file, not a binary file such as an application program.



## Using the simple selection function of a script template

Selecting an application from the EXEC resource enables you to automatically replace the necessary script template. You can simply create a script by editing the template script.

---

### Note:

To use this function, you must install the script template in advance. For how to obtain the script template.

---

1. From the tree view displayed in the left pane of the Builder, click the icon of the group containing the EXEC resource for which you want to replace the script template.
2. A group resource list is displayed in the table view to the right of the window. Right-click the target EXEC resource name and then click the **Details** tab of **Properties**.
3. On the **Details** tab, click **Script created with this product**.
4. Click **Template**.
5. The **Script Template** dialog box is displayed.

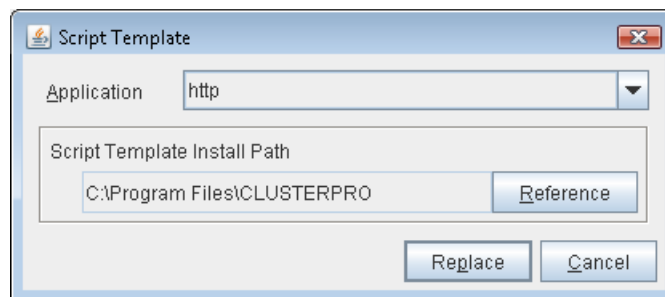

### Application

Clicking **Application** displays the replaceable script template applications in a list box.

---

### Note:

If the script template is not installed, nothing is displayed in the application list.

---

### Browse

Clicking **Browse** browses to the folder path where the script template is installed.

---

### Note:

If the script template is not installed in the default folder path, a warning message appears. If the script template is installed, specify the correct install path.

---

### Replace

Clicking **Replace** displays the script replacement confirmation dialog box.

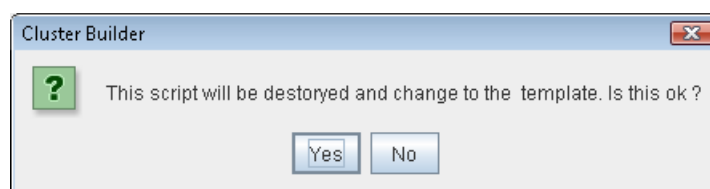

Clicking **OK** replaces the script.

---

### Note:

You must edit the replaced script to suit your environment. For how to edit the script, see “Displaying and changing the EXEC resource script created by the Builder”.

---

## Displaying and changing EXEC resource script using a user application

1. From the tree view displayed in the left pane of the Builder, click the icon of the group to which the EXEC resource whose detail information you want to display and change belongs.
2. Group resource list is displayed on the table view in the right pane of the window. Right-click the EXEC resource name. Then click **Properties** and select the **Details** tab.
3. Click **User Application** on the **Details** tab.
4. The settings of monitor resource can be displayed and/or changed by following the description below.

Select any file as the EXEC resource executable file. Specified executable file names are listed on **Scripts**. Executable files mean executable shell scripts and binary files.

The standard script editor, which is set to the Builder that operates on Linux, is vi. When closing the window for display and editing, close with the q command of vi.

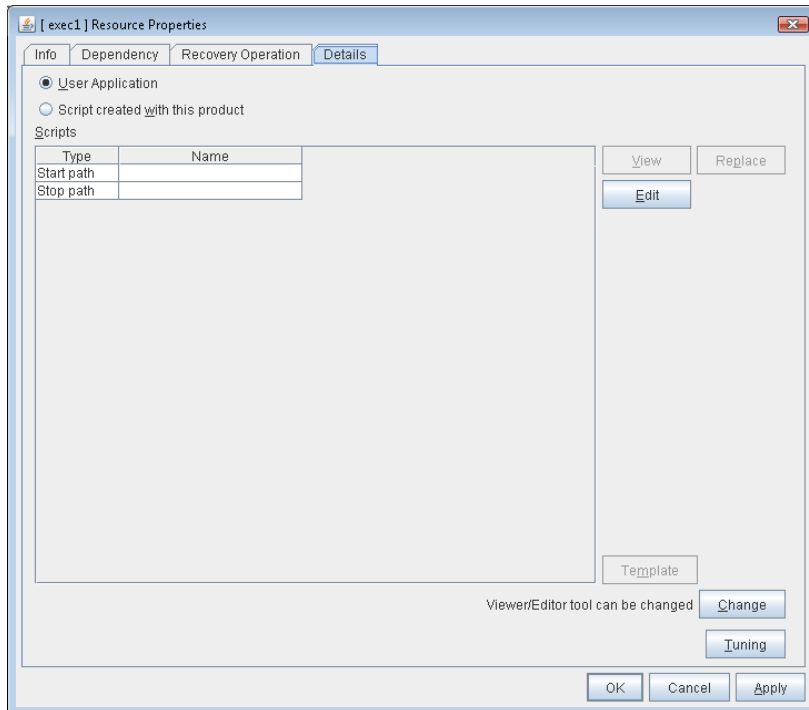

**Edit**

Specify an exec resource executable file name. The **Enter the application path** dialog box is displayed.

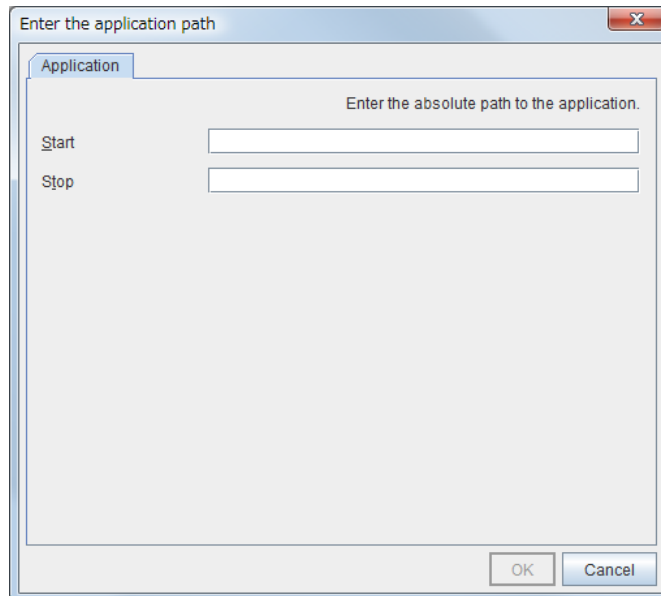

**Start** (Within 1023 bytes)

Enter an executable file name to be run when the exec resource starts. The name should begin with “/.” Arguments can also be specified.

**Stop** (Within 1023 bytes)

Enter an executable file name to be run when the exec resource exits. The name should begin with “/.” The stop script is optional.

For the executable file name, specify a full path name starting with “/” to a file on your cluster server.

Arguments can also be specified.

## Tuning EXEC resource

1. From the tree view displayed on the left pane of the Builder, click the icon of the group to which the EXEC resource whose detail information you want to display and change belongs.
2. Group resource list is displayed on the table view in the right pane of the window. Right-click the EXEC resource name. Then click **Properties** and select the **Details** tab.
3. Click **Tuning** on the **Details** tab. The **Exec Resource Tuning Properties** dialog box is displayed.
4. On the **Details** tab, you can see and/or change the settings of monitor resource by following the description below.

### Parameter tab

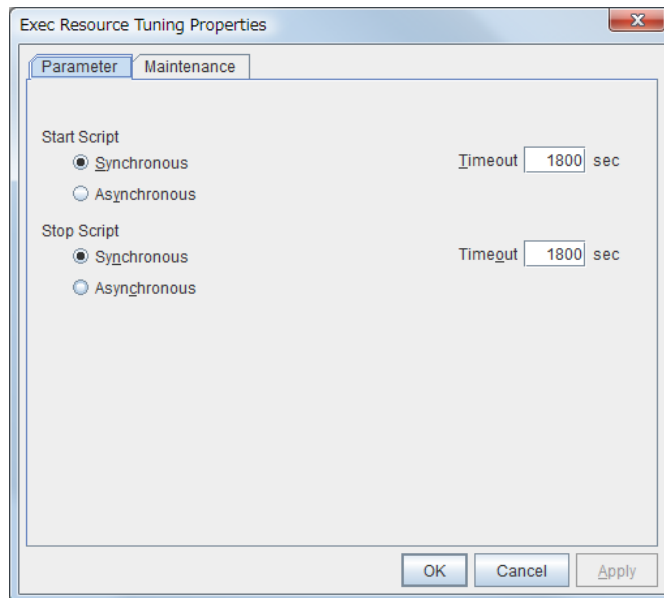

### Common to all start scripts and stop scripts

#### Synchronous

Waits for the script to end when it is run. Select this option for executable files that are not resident (the process is returned immediately after the script completion).

#### Asynchronous

Does not wait for the script to end when it is run. Select this for resident executable files. The script can be monitored by PID monitor resource if **Asynchronous** is selected.

#### Timeout 1 to 9999

When you want to wait for a script termination (when selecting **Synchronous**), specify how many seconds you want to wait before a timeout. This box is enabled when **Synchronous** is selected. Unless the script completes within the specified time, it is determined as an error.

**Maintenance tab**

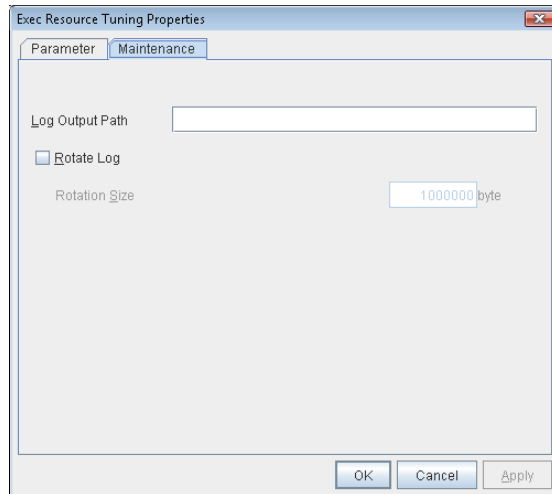

**Log Output Path** (Within 1023 bytes)

Specify the redirect destination path of standard output and standard error output for EXEC resource scripts and executable files. If this box is left blank, messages are directed to /dev/null. The name should begin with “/.”

If the **Rotate Log** check box is off, note the amount of available disk space in the file system because no limit is imposed on message output.

If the i686 version is used, the files must be periodically removed because EXEC resource activation and deactivation is disabled when the file size exceeds 2 GB.

If the **Rotate Log** check box is on, the log file to be output is rotated. Note the following items.

You must specify a log output path within 1009 bytes. If you specify a path of 1010 bytes or more, the log is not output.

You must specify a log file name within 31 bytes. If you specify a log file name of 32 bytes or more, the log is not output.

When using multiple custom monitor resources, the rotation size may not be normally recognized if you specify resources with the same file name, even if the paths differ (for example, /home/foo01/log/genw.log, /home/foo02/log/genw.log).

**Rotate Log**

Clicking **Rotate Log** when the **Rotate Log** check box is not checked outputs the execution logs of the EXEC resource script and the executable file without imposing any limit on the file size. Clicking **Rotate Log** when the **Rotate Log** check box is selected rotates and outputs messages.

**Rotation Size** 1 to 999999999

If the **Rotate Log** check box is selected, specify a rotation size.

The structures of the log files to be rotated and output are as follows:

File name	Description
file_name for the <b>Log Output Path</b> specification	Newest log
file_name.pre for the <b>Log Output Path</b> specification	Previously rotated log

## Displaying EXEC resource properties with the WebManager

1. Start the WebManager.
2. When you click an object for an EXEC resource  in the tree view, the following information is displayed in the list view.

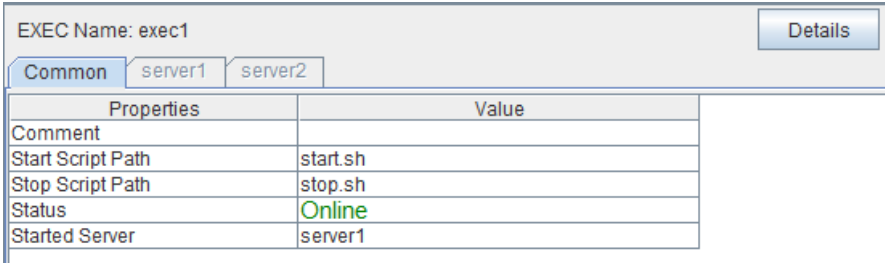

EXEC Name: exec1		Details
Common		server1
server2		
Properties	Value	
Comment		
Start Script Path	start.sh	
Stop Script Path	stop.sh	
Status	Online	
Started Server	server1	

Comment:	Comment
Start Script Path:	Path of the start script
Stop Script Path:	Path of the stop script
Status:	Resource status
Started Server :	Server name

If you click **Details**, the following information is displayed.

Properties	Value
Name	exec1
Type	exec
Failover Threshold	1
Retry Count at Activation Failure	0
Final Action at Activation Failure	No operation (not activate next resource)
Execute Script before Final Action	Off
Retry Count at Deactivation Failure	0
Final Action at Deactivation Failure	Stop the cluster service and shutdown OS
Execute Script before Final Action	Off
Depended Resources	fip101,disk1
Start Type	Synchronous
Stop Type	Synchronous
Start Script Timeout (sec)	1800
Stop Script Timeout (sec)	1800
Log Output Path	
Script Log Rotate	Off
Script Log Rotate Size (byte)	1000000
Script Log Rotate Generation	2

Name:	Resource name
Type:	Resource type
Failover Threshold:	Failover count
Retry Count at Activation Failure:	Activation retry count
Final Action at Activation Failure:	Final action at an activation error
Execute Script before Final Action:	Whether or not script is executed upon activation failure
Retry Count at Deactivation Failure:	Reactivation retry count
Final Action at Deactivation Failure:	Last action at a reactivation error
Execute Script before Final Action:	Whether or not script is executed upon deactivation failure
Dependent Resources:	Dependent resources
Start Type:	Start script type: synchronous/asynchronous
Stop Type:	Stop script type: synchronous/asynchronous
Start Script Timeout (sec):	Start script timeout for waiting the script to end (synchronous) (in seconds)
Stop Script Timeout (sec):	Stop script timeout for waiting the script to end (synchronous) (in seconds)
Log Output Path:	Script execution log type
Script Log Rotate:	Script log rotation
Script Log Rotate Size (bytes):	Script log rotation size (bytes)
Script Log Rotate Generation:	Script log rotation generation

# Understanding disk resource

## Dependencies of disk resource

Disk resource is supported by the following versions of EXPRESSCLUSTER by default.

Group Resource Type
Dynamic DNS resource
Floating IP resource
Virtual IP resource
Volume manager resource
AWS elastic ip resource
AWS virtual ip resource
Azure probe port resource

## Switching partitions

Switching partitions refer to partitions on shared disks connected to more than one server in a cluster.

Switching is done for each failover group according to the failover policy. By storing data required for applications on switching partitions, the data can be automatically used when failing over or moving failover group.

**Note:**

For "raw" disk type, EXPRESSCLUSTER maps (binds) the switching partition to the raw device of the OS. If Execute Unbind is selected on the Disk Resource Tuning Properties, the unbind process is performed to deactivate the disk resource.

If switching partitions are not accessible with the same device name on all the servers, configure the server individual setup.

i

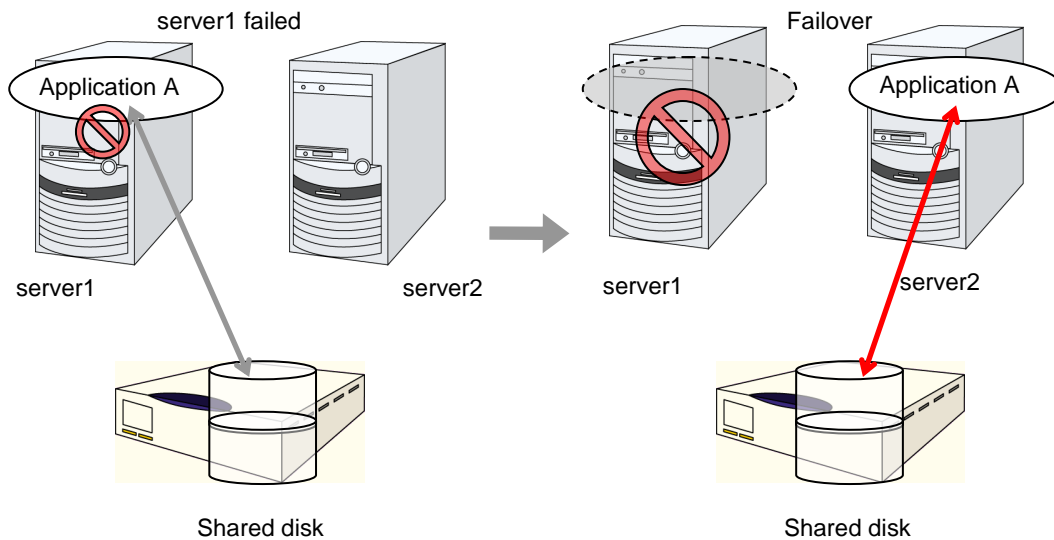



## Device region expansion on disk resources

Follow the steps below to execute region expansion of the device.

Be sure to execute the following steps on the server where the disk resource in question has been activated.

- (1) Deactivate a group to which the disk resource in question belongs by using a command such as `clpgrp`.
- (2) Confirm that no disks have been mounted by using a command such as `mount` and `df`.
- (3) Change the state of the disk from Read Only to Read Write by executing one of the following commands depending on the disk resource type.

```
# clproset -w -d <device-name>
```

- (4) Execute region expansion of the device.
- (5) Change the state of the disk from Read Write to Read Only by executing one of the following commands depending on the disk resource type.

```
# clproset -o -d <device-name>
```

- (6) Activate a group to which the disk resource in question belongs by using a command such as `clpgrp`.

## Notes on disk resources

- ◆ EXPRESSCLUSTER controls accesses to the file system (mount/umount). Thus, do not configure the settings about mount/umount on the OS.  
(If the entry to is required /etc/fstab, please use the noauto option is not used ignore option.)
- ◆ The partition device name set to the disk resource is in the read-only mode on all servers in a cluster. Read-only status is released when the server is activated.
- ◆ If **Mount/Umount Exclusion** is selected on the **Exclusion** tab of the **Cluster Prosperities**, it may take some time to activate or deactivate a disk resource because mount or unmount of disk resource, VxVM volume resource, NAS resource, and mirror resource is performed exclusively in the same server.
- ◆ When specifying path including symbolic link for mount point, Force Operation cannot be done even if it is chosen as operation in Detecting Failure.  
Similarly, if a path containing “//” is specified, forced termination will also fail.
- ◆ If you want to prevent behalf of the device in OS startup, udev devices the Please set the device name.  
example: /dev/disk/by-label/<device-name>
- ◆ When a change is made at the run level on the OS, some device files of a partition device set as a disk resource might be created again. This may reset the read-only setting for the partition device set as a disk resource.

### <When using a resource that has the disk type **LVM**>

- ◆ When using this setting, it is recommended to control a volume group by using a volume manager resource together. For details, see “Understanding volume manager resources” on page 771. of this guide.
- ◆ The volume is not defined on the EXPRESSCLUSTER side.

### <When using a resource that has the disk type **VXVM**>

- ◆ When using this setting, see “Understanding volume manager resources” on page 771.
- ◆ The volume is not defined on the EXPRESSCLUSTER side.
- ◆ No disk resource is needed when using only the accessible raw device  
(/dev/vx/rdisk/<disk-group-name>/<volume-name>) with the disk group imported and the volume started (raw access without setting up a file system on the volume).

## Displaying and changing the details of disk resource

1. From the tree view displayed on the left pane of the Builder, click the icon of the group to which the disk resource whose detailed information you want to display and/or change belongs.
2. The group resource list is displayed in the table view in the right pane of the window. Right-click the desired disk resource name, click **Properties**, and open the **Details** tab.
3. On the **Details** tab, you can see and/or change the settings by following the description on the next page.

### Disk Resource Properties: Details tab

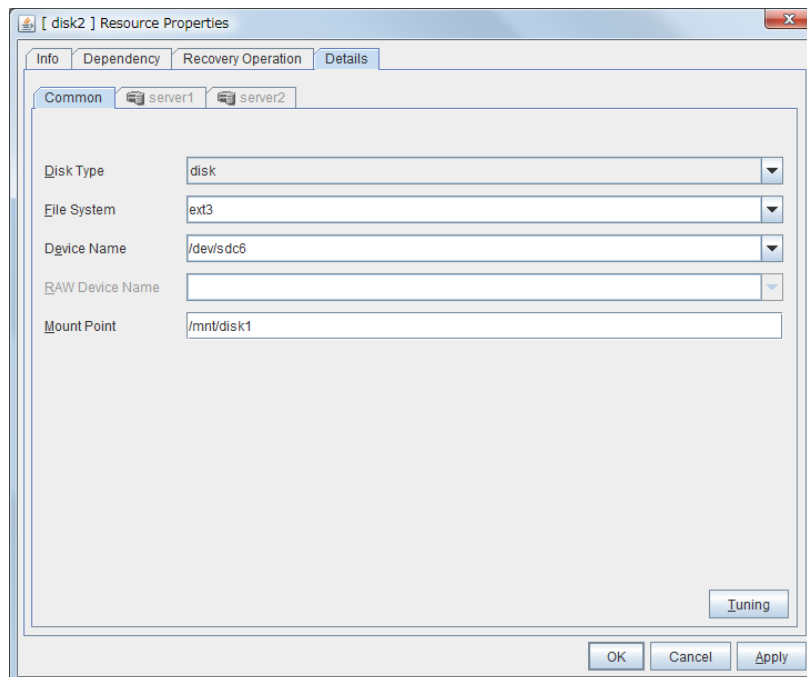

#### Disk Type **Server Individual Setup**

Select a disk type. You can only choose [disk].

Choose one of the types below.

- ◆ DISK
- ◆ RAW
- ◆ LVM
- ◆ VXVM

**File System** **Server Individual Setup**

You select a file system type created on the disk device. Choose one from the types described below. You may also directly enter the type. This setting is necessary when the setting to **Disk Type** is other than **raw**.

- ◆ ext3
- ◆ ext4
- ◆ xfs
- ◆ reiserfs
- ◆ vxfs

**Device Name** (Within 1023 bytes) **Server Individual Setup**

Select the disk device name to be used for disk resources. Otherwise, you can enter the device name. The name should begin with “/.”

**Raw Device Name** (within 1,023 bytes) **Server Individual Setup**

Enter the raw disk device name to be used for disk resources. This setting is necessary when the setting to **Disk Type** is **raw** or **vxvm**.

**Mount Point** (Within 1023 bytes) **Server Individual Setup**

Enter the directory to mount the disk device. The name should begin with “/.” This setting is necessary when the setting to **Disk Type** is other than **raw**.

**Tuning**

Opens the **Disk Resource Tuning Properties** dialog box. Make detailed settings on the dialog box.

**Disk Resource Tuning Properties(when the setting to Disk Type is other than raw)****Mount tab**

The detailed settings related to mount are displayed.

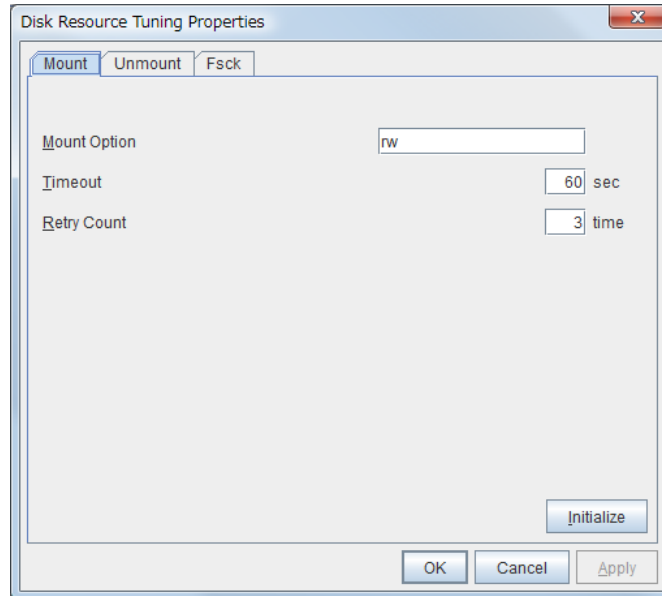
**Mount Option**

Enter options to give the mount command when mounting the file system on the disk device. More than one option is delimited with a comma “,”.

A mount option sample

Setting item	Setting value
Device name	/dev/sdb5
Mount point	/mnt/sdb5
File system	ext3
Mount option	rw,data=journal

The mount command to be run with the above settings is:

```
mount -t ext3 -o rw,data=journal /dev/sdb5 /mnt/sdb5
```

**Timeout** 1 to 999

Enter how many seconds you want to wait for the mount command completion before its timeout when you mount the file system on the disk device.

If the file system has a large size of disk space, it may take some time for the command to complete. Make sure to specify the value that is enough for the mount command completion.

**Retry Count** 0 to 999

Enter how many times you want to retry to mount the file system on the disk device when one fails.

If you set this to zero (0), mount will not be retried.

### Initialize

Clicking **Initialize** resets the values of all items to the default values.

### Unmount tab

The detailed settings related to unmount are displayed.

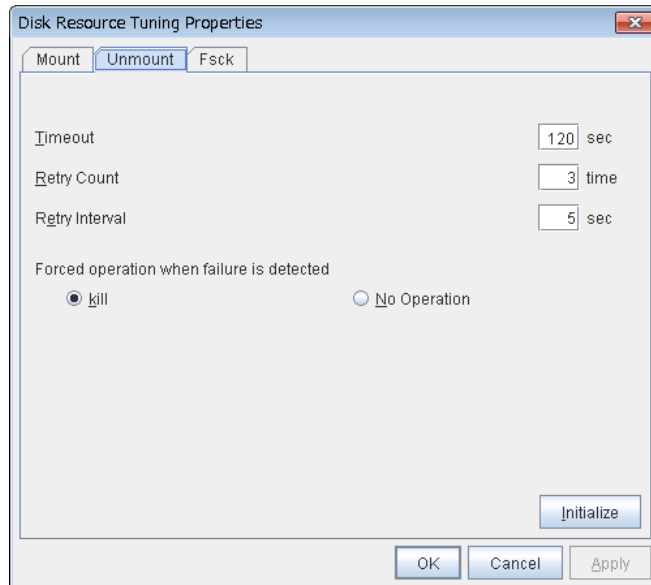

#### Timeout 1 to 999

Enter how many seconds you want to wait for the unmount command completion before its timeout when you unmount the file system on the disk device.

#### Retry Count 0 to 999

Enter how many times you want to retry to unmount the file system on the disk device when one fails. If this is set to zero (0), unmount will not be retried.

#### Retry Interval 0 to 999

Enter the interval in which you want to retry unmounting the file system on the disk device when unmounting fails.

#### Forced Operation When Detecting Failure

Select an action to be taken at an unmount retry if unmount is failed.

- ◆ kill  
Select this to try to kill the processes that are accessing the mount point. Not always the process can be killed.
- ◆ No Operation  
Select this not to try to kill the processes that are accessing the mount point.

### Initialize

Clicking **Initialize** resets the values of all items to the default values.

### Fsck tab

The detailed settings related to fsck are displayed. The tab appears only if [xfs] is set for the file system.

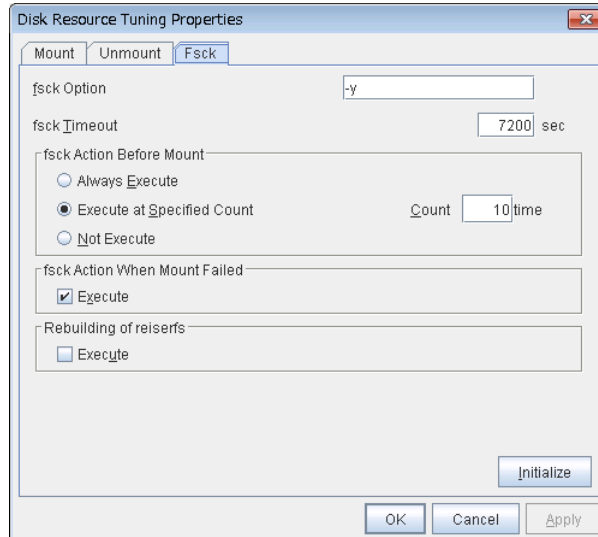

#### fsck Option (Within 1023 bytes)

Enter options to give to the fsck command when checking the file system on disk device. Options are delimited with a space. Specify options so that the fsck command does not work interactively. Otherwise, you may not be allowed to mount until the “fsck timeout” elapses. When the file system is reiserfs, the fsck command works interactively. However, it can be avoided if EXPRESSCLUSTER gives “Yes” to reiserfsck.

#### fsck Timeout 1 to 9999

Enter how many seconds you want to wait for the fsck command completion before its timeout when you check the file system on the disk device. If the file system has a large size of disk space, it may take some time for the command to complete. Make sure to specify the value that is enough for the mount command completion.

#### fsck action before mount

Select an fsck action before mounting file system on a disk device from the following choices:

- ◆ Always Execute  
fsck is executed before mounting the file system.
- ◆ Execute at Specified Count  
fsck is executed when resource is activated successfully within the count specified by **Count**.  
= Count (0 to 999)
- ◆ Not Execute  
fsck is not executed before mounting the file system.

---

#### Note:

The number of times to execute fsck is not related to the check interval managed by a file system.

---

### fsck Action When Mount Failed

Set an fsck action when detecting a mount failure on a disk device. This setting is enabled when the setting of Mount **Retry Count** is other than zero.

- ◆ When the check box is selected:  
Mount is retried after running fsck.
- ◆ When the check box is not selected:  
Mount is retried without running fsck.

---

#### Note:

It is not recommended to set “Not Execute” fsck action before performing mount. With this setting, disk resource does not execute fsck and disk resource cannot be failed over when there is an error that can be recovered by fsck in the switchable partition.

---

### Rebuilding of Reiserfs

Specify the action when reiserfsck fails with a recoverable error.

- ◆ When the checkbox is selected  
`reiserfsck --fix -fixable` is executed.
- ◆ When the checkbox is not selected  
Recovery is not performed even if reiserfsck fails with a recoverable error.

### Initialize

Clicking **Initialize** resets the values of all items to the default values.

### xfs\_repair tab

The detailed settings related to [xfs\_repair] are displayed. The tab appears only if [xfs] is set for the file system.

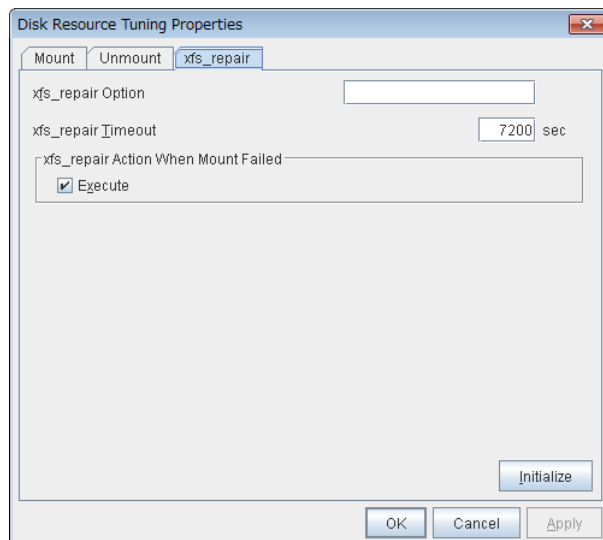

### xfs\_repair Option (Within 1023 bytes)

Enter the option to give to the [xfs\_repair] command when checking the file system on the disk device. To enter multiple options, delimit each with a space.



**xfs\_repair Timeout (1-9999)**

Enter how many seconds you want to wait for the [xfs\_repair] command completion before its timeout when you check the file system on the disk device. If the file system has a large size of disk space, it may take some time for the command to complete. Make sure that the value to set is not too small.

**xfs\_repair Action When Mount Failed**

Set the [xfs\_repair] action when mounting the file system on the disk device fails. This setting is enabled when the setting of **Mount Retry Count** is other than zero.

- ◆ When the check box is selected:  
Mount is retried after running [xfs\_repair].
- ◆ When the check box is not selected:  
Mount is retried without running [xfs\_repair].

**Initialize**

Clicking **Initialize** resets the values of all items to the default values.

### Disk Resource Tuning Properties (when the setting to Disk Type is raw)

#### Unbind tab

The detailed settings related to unbind are displayed.

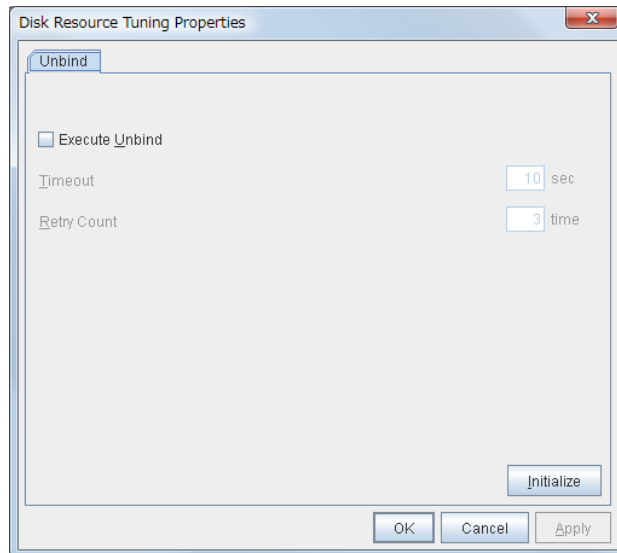

#### Execute Unbind

Specify whether to execute unbind a raw disk device.

- ◆ When the check box is selected:  
Execute unbind a raw disk device.
- ◆ When the check box is not selected:  
Do not execute unbind a raw disk device.

#### Timeout (1 to 999)

When the **Execute Unbind** check box is selected, Set the time-out for the unbind completion of the raw disk device.

#### Retry Count (1 to 999)

When the **Execute Unbind** check box is selected, Specify the retry count to unbind the raw disk device when one fails.

#### Initialize

Clicking **Initialize** resets the values of all items to the default values.

## Displaying the disk resource properties with the WebManager

1. Start the WebManager.
2. When you click an object for a disk resource  in the tree view, the following information is displayed in the list view.

DISK Name: disk2		Details	
Common		server1	server2
Properties	Value		
Comment			
Disk Type	disk		
File System	ext3		
Device Name	/dev/sdc6		
Raw Device Name			
Mount Point	/mnt/disk2		
Status	Online		
Started Server	server2		

Comment:	Comment
Disk Type:	Type of the disk device
File System:	Type of the file system created on the disk device
Device Name:	Name of the disk device used as disk resource
Raw Device Name:	Name of the disk device used as raw disk resource
Mount Point:	Directory where the disk device is mounted
Status:	Disk resource status
Started Server:	Server name

If you click **Details**, the following information is displayed.

Properties	Value
Name	disk1
Type	disk
Failover Threshold	1
Retry Count at Activation Failure	0
Final Action at Activation Failure	No operation (not activate next resource)
Execute Script before Final Action	Off
Retry Count at Deactivation Failure	0
Final Action at Deactivation Failure	Stop the cluster service and shutdown OS
Execute Script before Final Action	Off
Depended Resources	
Mount Option	rw
Mount Timeout (sec)	60
Mount Retry Count	3
Fsck Action When Mount Failed	Execute
Unmount Timeout (sec)	120
Unmount Retry Count	3
Unmount Retry Interval	5
Action at Unmount Failure	kill
Fsck Option	-y
Fsck Timeout (sec)	7200
Fsck Action Before Mount	Execute at Specified Count
Fsck Interval	10
Re-restoration of Reiserfs	None
Xfs_repair Action When Mount Failed	Execute
Xfs_repair Option	
Xfs_repair Timeout (sec)	7200

Name:	Disk resource name
Type:	Resource type
Failover Threshold:	Failover count
Retry Count at Activation Failure:	Activation retry count
Final Action at Activation Failure:	Final action at activation failures
Execute Script before Final Action:	Whether or not script is executed upon activation failure
Retry Count at Deactivation Failure:	Reactivation retry count
Final Action at Deactivation Failure:	Final action at reactivation failures
Execute Script before Final Action:	Whether or not script is executed upon deactivation failure
Dependent Resources:	Dependent resource
Mount Option:	Mount option
Mount Timeout (sec):	Mount timeout (in seconds)
Mount Retry Count:	Mount retry count
Fsck Action When Mount Failed	Action to be taken at a mount error <ul style="list-style-type: none"> <li>• No action</li> <li>• Perform fsck</li> </ul>
Unmount Timeout (sec):	Unmount timeout (in seconds)
Unmount Retry Count:	Unmount retry count
Unmount Retry Interval:	Unmount retry interval (in seconds)
Action at Unmount Failure:	Action to be taken at an unmount error <ul style="list-style-type: none"> <li>kill Force termination</li> <li>No Operation No action</li> </ul>
Fsck Option:	Options passed to the fsck command
Fsck Timeout (sec):	Timeout for the fsck command execution (in seconds)
Fsck Action Before Mount	fsck timing when performing mount <ul style="list-style-type: none"> <li>• Do not perform fsck</li> <li>• Always perform fsck</li> <li>• Perform fsck at fsck interval</li> </ul>
Fsck Interval:	fsck interval
Follow-up recovery of reiserfs	Action to be taken at reiserfsck failure <ul style="list-style-type: none"> <li>• No action</li> <li>• Perform recovery</li> </ul>

Xfs_repair Action When Mount Failed	Action to be taken at a mount error <ul style="list-style-type: none"><li>• No action</li><li>• Perform xfs_repair</li></ul>
Xfs_repair Option:	Options passed to the xfs_repair command
Xfs_repair Timeout (sec):	Timeout for the xfs_repair command execution (in seconds)

## Understanding floating IP resource

### Dependencies of floating IP resource

By default, this function does not depend on any group resource type.

### Floating IP

Client applications can use floating IP addresses to access cluster servers. By using floating IP addresses, clients do not need to be aware of switching access destination server when a failover occurs or moving a group migration.

Floating IP addresses can be used on the same LAN and over the remote LAN.

Execute the `[ifconfig]` command or the API to assign an IP address to the OS. The floating IP resource automatically determines whether to execute the `[ifconfig]` command or the API. The following shows an example:

- ◆ For an environment such as RHEL 7 or later (including RHEL compatible operating systems) on which the `[ifconfig]` command cannot be used, the API is executed.
- ◆ For an environment such as RHEL 7 or later (including RHEL compatible operating systems) on which the `net-tools` package enables execution of the `[ifconfig]` command, the API is executed because the output format of the `[ifconfig]` command is not compatible with that of RHEL 6 or earlier.
- ◆ For an environment such as RHEL 6 on which the `[ifconfig]` command can be used, the `[ifconfig]` command is executed.

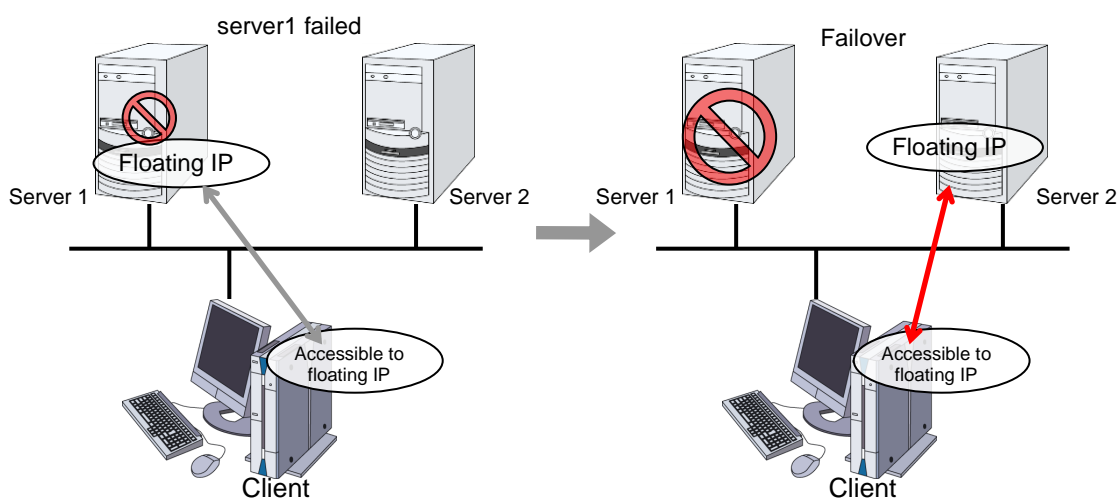

#### Address assignment

An IP address to assign for floating IP address needs to meet the condition described below:

- ◆ Available host address which is in the same network address as the LAN that the cluster server belongs

Allocate as many IP addresses that meet the above condition as required (generally as many as failover groups). These IP addresses are the same as general host addresses, therefore, global IP addresses can be assigned such as Internet.

**Switching method**

For IPv4, MAC addresses on the ARP table are switched by sending ARP broadcasting packets from the server on which FIP resources are activated.

For IPv6, ARP broadcasting packets are not sent.

The table below shows the information of ARP broadcasting packets sent by EXPRESSCLUSTER:

	0	1	2	3
	ff	ff	ff	ff
ff	ff	MAC address		
(6 bytes)				
08	06	00	01	
08	00	06	04	
00	02			
MAC address (6 bytes)				
FIP address (4 bytes)				
MAC address (6 bytes)				
			FIP address	
(4 bytes)			00 00	
00	00	00	00	
00	00	00	00	
00	00	00	00	
00	00	00	00	

**Routing**

You do not need to configure the settings for the routing table.

**Conditions to use**

Floating IP addresses are accessible to the following machines:

- ◆ Cluster server itself
- ◆ Other servers in the same cluster and the servers in other clusters
- ◆ Clients on the same LAN as the cluster server and clients on remote LANs

If the following conditions are satisfied, machines other than the above can also access floating IP addresses. However, connection is not guaranteed for all models or architectures of machines. Test the connection thoroughly by yourself before using those machines.

- ◆ TCP/IP is used for the communication protocol.
- ◆ ARP protocol is supported.

Even over LANs configured with switching hubs, floating IP address mechanism works properly. When a server goes down, the TCP/IP connection the server is accessing will be disconnected.

## Notes on floating IP resource

- ◆ Do not execute a network restart on a server on which floating IP resources are active. If the network is restarted, any IP addresses that have been added as floating IP resources are deleted.
- ◆ IP address overlaps due to time-lag of the [ifconfig] command

If the following is set to the floating IP resource, the failover of resources may fail:

- When a value smaller than the default is set to **Retry Count at Activation Failure**.
- When **Ping Retry Count** and **Ping Interval** are not set.

This problem occurs due to the following causes:

- Releasing IP address may take time depending on the specification of the [ifconfig] command after deactivating the floating IP address on the server from which the resource is failed over.
- On the activation of the floating IP address on the server to which the resource is failed over, if the ping command is run to the IP address to prevent dual activation, ping reaches the IP address because of the reason above, and the resource activation error occurs.

Make the following settings to avoid this problem:

- Set a greater value to **Retry Count at Activation Failure** of the resource (default: 5 times).
- Set greater values to **Ping Retry Count** and **Ping Interval**.

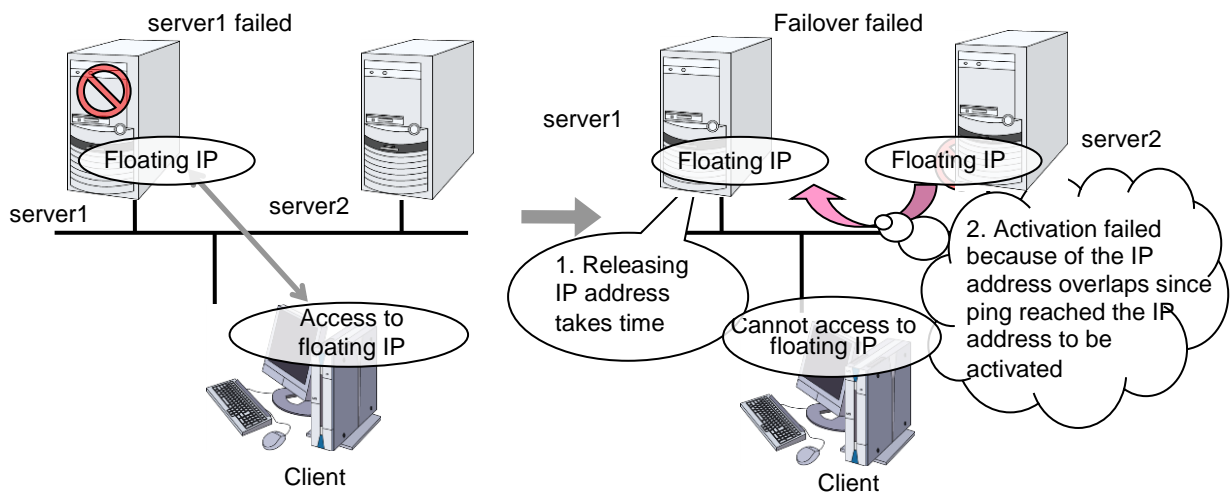



◆ IP address overlaps when OS is stalled

If OS stalls with the floating IP address activated, the resource failover may fail when the following settings are made:

- A value other than 0 is set to **Ping Timeout**.
- **Forced FIP Activation** is off.

This problem occurs due to the following causes:

- A part of OS stalls (as examples below) with the floating IP address activated.
  - Network modules are running and respond to ping from other nodes
  - A stall cannot be detected in the user-mode monitor resource
- When activating the floating IP address on the server to which the resource is failed over, if the ping command is executed to the IP address to be activated in order to prevent redundant activation, ping reaches the IP address because of the reason above, and the resource activation error occurs.

In the machine environment where this problem often occurs, this can be prevented by the settings below. However, both groups may be activated depending on the status of a stall, and server shutdown may occur depending on the timing of the activation of both groups. For details on activation of both groups, see “What causes servers to shut down Recovery from network partition” in Chapter 10, “The system maintenance information” in this guide.

- Specify 0 to **Ping Timeout**  
Overlap check is not performed to the floating IP address.
- Specify “On” to **Forced FIP Activation**  
The floating IP address is activated forcibly even when the address is used on a different server.

When the **ping Timeout** setting is other than 0 and **Forced FIP Activation** is OFF

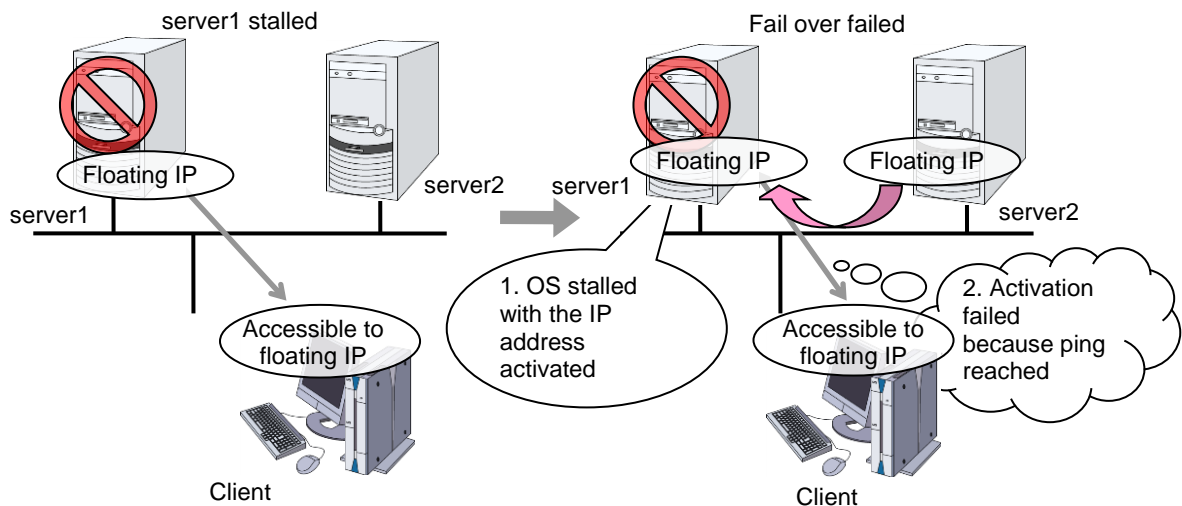

When **Ping timeout** setting is 0

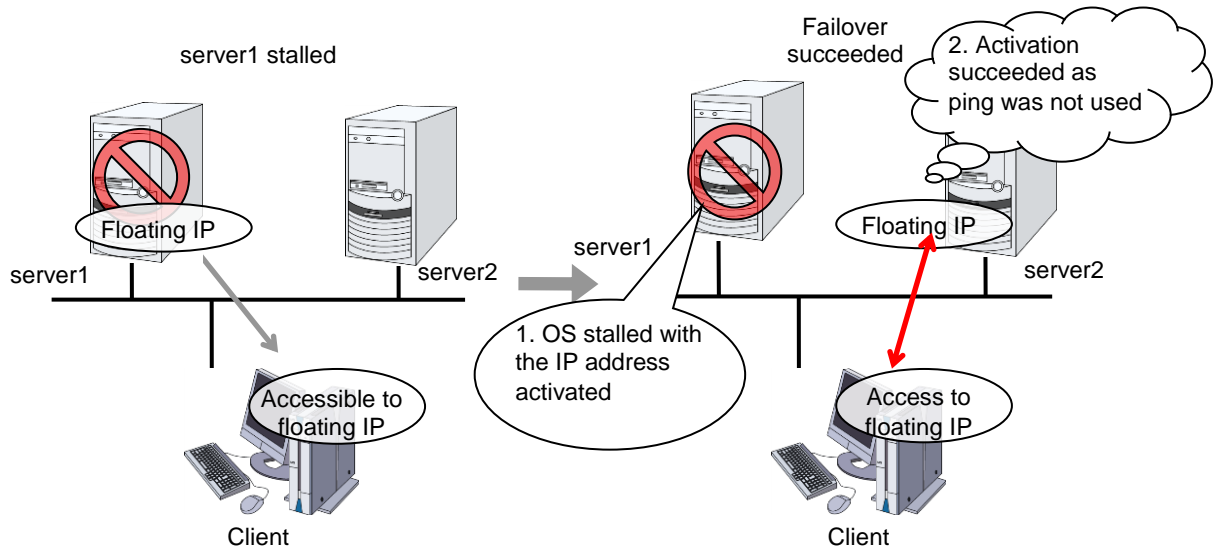

When **Ping Timeout** setting is other than 0 and **Forced FIP Activation** is On.

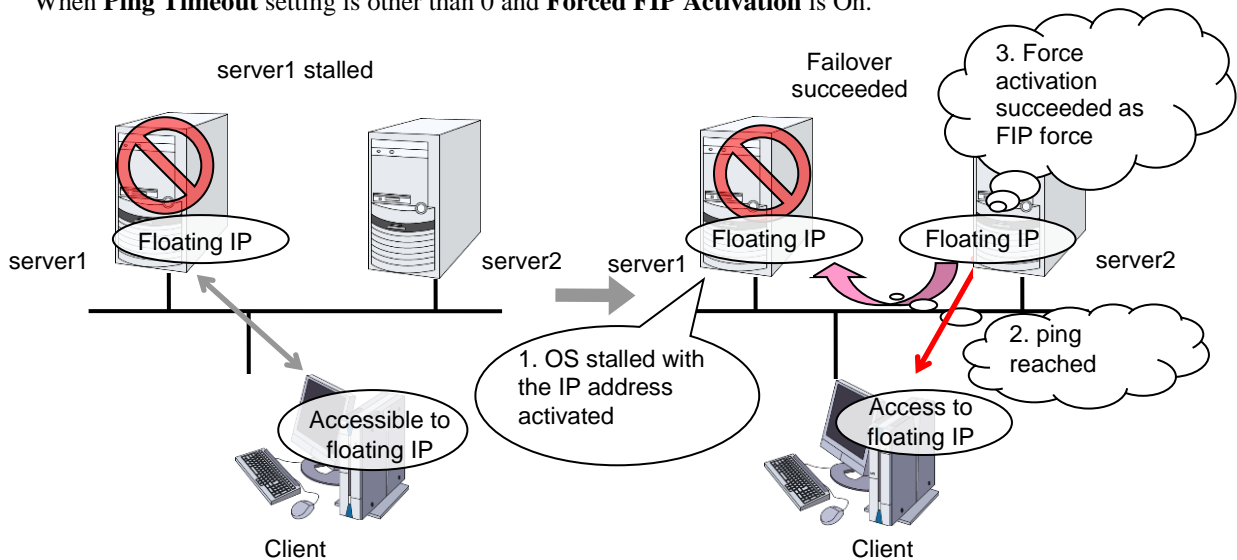

- ◆ MAC address of virtual NIC to which floating IP is allocated.

When the floating IP resource fails over, the corresponding MAC address is changed because the MAC address of virtual NIC to which the floating IP is allocated is the MAC address of real NIC.

- ◆ Source address of IP communication from the running server when the resource activation.

The source address from the server is basically the real IP of the server even though the floating IP resource has activated. When you want to change the source address to the floating IP, the settings are necessary on the application.

- ◆ When **Forced FIP Activation** is set to **ON**, if a floating IP address is activated, and then a machine in the same network segment connects to a floating IP address, the connection may be established with a machine that previously used that IP address.
- ◆ floating IP resource does not supported by the environment that OpenVPN has started.
- ◆ The NIC name (the name of a network interface card, such as eth0) is up to 15 characters long. If the length of the name exceeds 15 characters, the activation failure occurs. Modify the NIC name in such a case.
- ◆ Before activating a floating IP resource, [ping] is issued to check whether there is a duplicated IP address. Therefore, if rejection of ICMP reception via a firewall is set to a network device that uses a duplicated IP address, a floating IP address might be duplicated because the existence of duplicated IP addresses cannot be checked by using a [ping] command.

## Waiting process for floating IP resource deactivation

The following process takes place after deactivating of floating IP address.

1. Waiting process
  - Execute the [ifconfig] command or the API to acquire a list of IP addresses assigned to the OS. The floating IP resource automatically determines whether to execute the [ifconfig] command or the API. If no floating IP address exists in the IP address list, it is regarded as deactive.
  - If a floating IP address exists in the IP addresses, one-second waiting takes place. This setting cannot be changed with the Builder.
  - The operation mentioned above is repeated for up to four times at maximum. This number of times cannot be changed by the Builder.
  - When it results in an error, whether the floating IP resource is regarded as having a deactivation error can be changed with **Status at Failure** under **Confirm I/F Deletion** on the **Deactivity Check** tab of the floating IP resource.
2. Confirming process by the ping command
  - The ping command is executed to check if there is a response from the floating IP address. If there is no response, it is regarded as deactive.
  - When there is a response from the floating IP address, one-second waiting takes place. This setting cannot be changed with the Builder.
  - The operation mentioned above is repeated for up to four times at maximum. This number of times cannot be changed by the Builder.
  - The ping command is executed with one-second timeout. You cannot change this timeout.
  - When it results in an error, the status of floating IP resource can be changed in **Status at Failure** under **Confirm I/F Response** on the **Deactivity Check** on the **Deactivity Check** tab of the floating IP resource.

---

**Note:**

---

---

Acquisition of the list of IP addresses and floating address activation/deactivation using the [ifconfig] command timeout in 60 seconds (this is the default value). This timeout value can be changed by the Builder. For details, see the **Parameter tab** of the **Floating IP Resource Tuning Properties** on Page 682.

---

## Displaying and changing the details of floating IP resource

1. From the tree view displayed on the left pane of the Builder, click the icon of the group to which the floating IP resource whose detailed information you want to display and/or change belongs.
2. The group resource list is displayed in the table view in the right pane of the window. Right-click the desired floating IP resource name, click **Disk Resource Properties** and select the **Details** tab.
3. On the **Details** tab, you can see and/or change the settings by following the description below.

### Floating IP Resource Detail tab

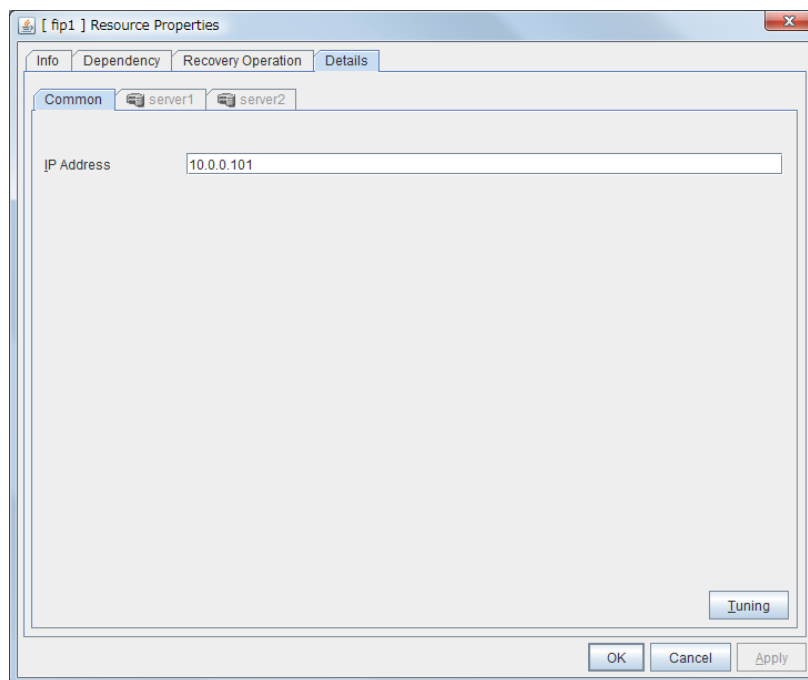

#### IP Address **Server Individual Setup**

Enter the floating IP address to be used. When setting the bonding, specify the bonding interface name by using “%” to separate. For details, see “Bonding” in Chapter 8, “Information on other settings” in this guide.

- ◆ Example: 10.0.0.12%bond0

The floating IP resource searches for the address on a local computer having the same subnet mask, assuming there to be, by default, 24 mask bits for IPv4 or 128 bits for IPv6. Then, it assigns an alias to the relevant network interface to add a floating IP address.

To specify a number of mask bits explicitly, specify the address followed by **/number\_of\_mask\_bits**. (For an IPv6 address, be sure to specify **/number\_of\_mask\_bits**.)

Example: fe80::1/8

To specify a network interface explicitly, specify the address followed by **%interface\_name**.

Example: fe80::1/8%eth1

In the above example, a floating IP address with eight mask bits is added to network interface eth1.

When setting the tag VLAN Please specify the I / F name of tag VLAN, separated by the "%".

- ◆ example in the case of setting the tag VLAN: 10.0.0.12% eth0.1

In an environment in which an IPv6 address and the [ifconfig] command can be used, be sure to match the output format of the [ifconfig] command and the IP address notation of the floating IP because the environment is case sensitive.

### Tuning

Opens the **Floating IP Resource Tuning Properties** dialog box where the detailed settings for the floating IP resource can be configured.

### Server Individual Setup

Opens the **Server Individual Setup** dialog box. Set the floating IP addresses which are different depending on a server.

### Floating IP Resource Tuning Properties

#### Parameter tab

Detailed settings on parameters for floating IP resource are displayed.

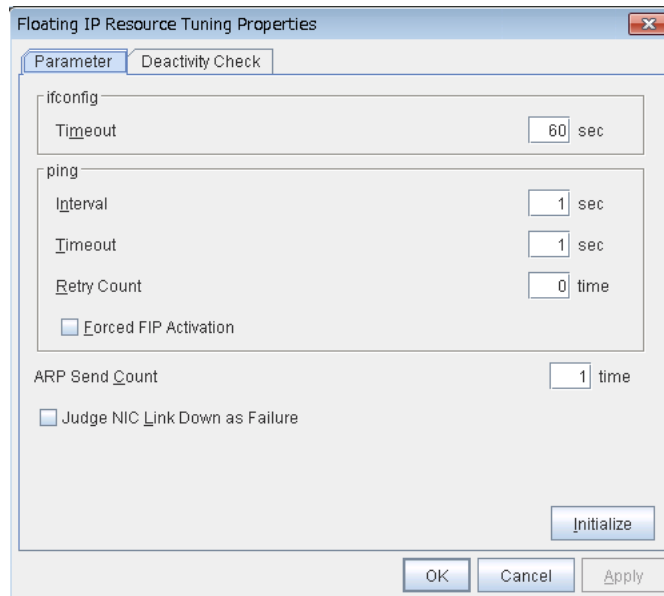

#### ifconfig

The following is the detailed settings on getting IP addresses and on the [ifconfig] command executed for the activation and/or deactivation of the floating IP resource.

- ◆ **Timeout 1 to 999**  
Make the setting of the timeout of [ifconfig] command. This parameter is not available in an environment in which the [ifconfig] command cannot be used. Therefore, specify 60 seconds (default value for such an environment).

**ping**

These are the detailed settings of the ping command is used to check if there is any overlapped IP address before activating floating IP resource.

- ◆ **Interval** 0 to 999  
Set the interval to issue the ping command.
- ◆ **Timeout** 0 to 999  
Set timeout of the ping command.  
If zero is set, the ping command is not run.
- ◆ **Retry count** 0 to 999  
Set retry count of the ping command.
- ◆ **Forced FIP Activation**  
Specify whether to forcibly activate floating IP address when an overlapped IP address is detected by command check.
  - When the check box is selected  
Forced activation is performed.
  - When the check box is not selected  
Forced activation is not performed.

**ARP Send Count** 0 to 999

Specify how many times you want to send ARP packets when activating floating IP resources.

If this is set to zero (0), ARP packets will not be sent.

**Judge NIC Link Down as Failure**

Specify whether to check for an NIC Link Down before the floating IP resource is activated. In some NIC boards and drivers, the required ioctl( ) may not be supported. To check the availability of the NIC Link Up/Down monitor, use the [ethtool] command provided by the distributor. For the check method using the [ethtool] command, see “Note on NIC Link Up/Down monitor resources” in “Understanding NIC Link Up/Down monitor resources” in Chapter 5 of this guide.

- When the check box is selected  
In the case of an NIC Link Down, the floating IP resource is not activated.
- When the check box is not selected  
Even in the case of an NIC Link Down, the floating IP resource is activated. This operation is the same as before.

**Initialize**

Clicking **Initialize** resets the values of all items to the default values.

### Deactivity Check tab

Detailed settings on deactivity check of floating IP resource are displayed.

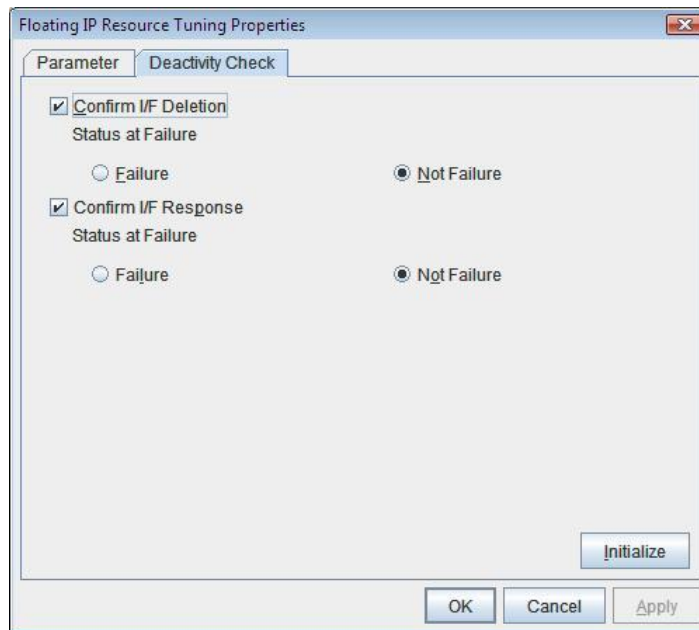

#### Confirm I/F Deletion

- ◆ **Confirm I/F Deletion**  
Specify whether to confirm, whether the target floating IP address has been deleted successfully after the floating IP is deactivated.
  - When the check box is selected  
Confirmation is performed.
  - When the check box is not selected  
Confirmation is not performed.
- ◆ **Status at Failure**  
Specify how to handle a deactivation error of the floating IP resource.
  - **Failure:**  
Treats as a deactivity failure of a floating IP resource.
  - **Not Failure:**  
Do not treat as a deactivity failure of a floating IP resource.



**Confirm I/F Response**

- ◆ **Confirm I/F Response**  
Specify whether to confirm, using the ping command, whether the target floating IP address has been deleted successfully after the floating IP is deactivated.
  - When the check box is selected  
Confirmation is performed.
  - When the check box is not selected  
Confirmation is not performed.
- ◆ **Status at Failure**  
Specify how to handle a deactivation error of the floating IP resource if the floating IP can be reached by the ping command.
  - **Failure:**  
Treats as a deactivity failure of a floating IP resource.
  - **Not Failure:**  
Do not treat as a deactivity failure of a floating IP resource.

## Displaying the property of floating IP resource with the WebManager

1. Start the WebManager.
2. When you click an object for a floating IP resource  in the tree view, the following information is displayed in the list view.

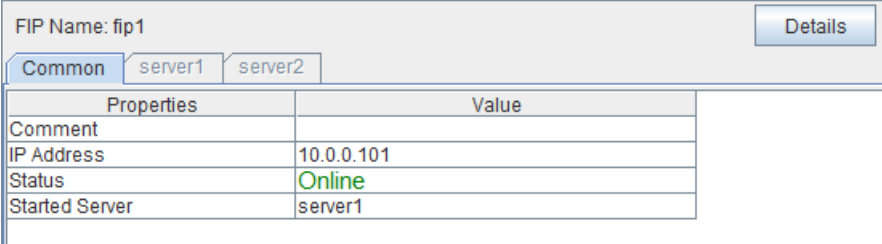

The screenshot shows a window titled 'FIP Name: fip1' with a 'Details' button. Below the title bar are tabs for 'Common', 'server1', and 'server2'. A table displays the properties of the floating IP resource:

Properties	Value
Comment	
IP Address	10.0.0.101
Status	Online
Started Server	server1

Comment:

IP Address:

Status:

Started Server:

Comment

IP address used by floating IP resource

Status of floating IP resource

Server name

If you click **Details**, the following information is displayed.

Properties	Value
Name	fip1
Type	fip
Failover Threshold	1
Retry Count at Activation Failure	5
Final Action at Activation Failure	No operation (not activate next resource)
Execute Script before Final Action	Off
Retry Count at Deactivation Failure	0
Final Action at Deactivation Failure	Stop the cluster daemon and shutdown OS
Execute Script before Final Action	Off
Depended Resources	
Ping Timeout (sec)	1
Ping Retry Count	0
Ping Interval (sec)	1
FIP Force Activation	Off
ARP Send Count	1
Ifconfig Timeout (sec)	60
Ifconfig Status at Failure	Not Failure
Ping Status at Failure	Not Failure

Name:	Floating IP resource name
Type:	Resource type
Failover Threshold:	Failover count
Retry Count at Activation Failure:	Activation retry count
Final Action at Activation Failure:	Final action at activation error
Execute Script before Final Action:	Whether or not script is executed upon activation failure
Retry Count at Deactivation Failure:	Deactivation retry count
Final Action at Deactivation Failure:	Final action at deactivation error
Execute Script before Final Action:	Whether or not script is executed upon deactivation failure
Dependent Resources:	Dependent resource
Ping Timeout (sec):	Timeout of ping to confirm redundancy (in seconds)
Ping Retry Count:	Ping retry count
Ping Interval(sec):	Ping interval (in seconds)
FIP Force Activation:	Forced Floating IP Activation
ARP Send Count:	ARP send count
Ifconfig Timeout (sec):	Timeout of ifconfig command timeout (in seconds)
Ifconfig Status at Failure:	Status of inactivation check ifconfig error
PingStatus at Failure:	Status of inactivation check ping error

## Understanding virtual IP resources

### Dependencies of virtual IP resources

By default, this function does not depend on any group resource type.

### Virtual IP resources

Client applications can be connected to a cluster server by using a virtual IP address. The servers can be connected to each other by using a virtual IP address. By using a virtual IP address, switching from one server to the other to which a client is connecting remains transparent even if failover or moving of a failover group occurs. The graphic in the next page shows how virtual IP resources work in the cluster system.

Execute the `[ifconfig]` command or the API to assign an IP address to the OS. The floating IP resource automatically determines whether to execute the `[ifconfig]` command or the API. The following shows an example:

- ◆ For an environment such as RHEL 7 or later (including RHEL compatible operating systems) on which the `[ifconfig]` command cannot be used, the API is executed.
- ◆ For an environment such as RHEL 7 or later (including RHEL compatible operating systems) on which the `net-tools` package enables execution of the `[ifconfig]` command, the API is executed because the output format of the `[ifconfig]` command is not compatible with that of RHEL 6 or earlier.
- ◆ For an environment such as RHEL 6 on which the `[ifconfig]` command can be used, the `[ifconfig]` command is executed.

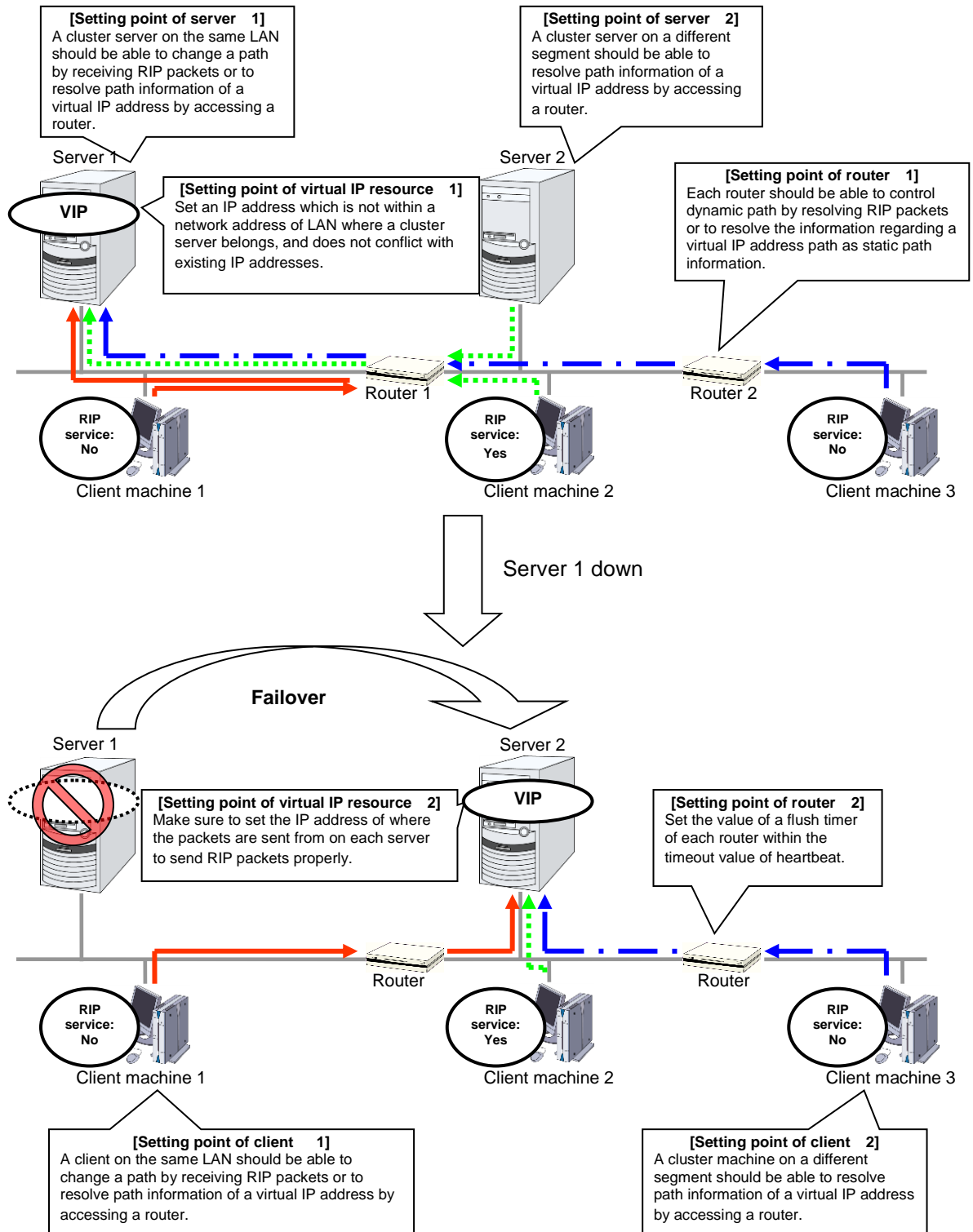

## Determining virtual IP address

An IP address used as a virtual IP address should satisfy the following conditions:

- ◆ The IP address should not be within the network address of the LAN to which the cluster belongs.
- ◆ The IP address should not conflict with existing network addresses.

Select one of the following allocation methods to meet the requirements above:

- ◆ Obtain a new network IP address for virtual IP address and allocate virtual IP address.
- ◆ Determine a network IP address from private IP address space and allocate virtual IP address. The following procedures are given as an example.
  - Select one network address from 192.168.0 to 192.168.255 for virtual IP address.
  - Allocate up to 64 host IP addresses for virtual IP address from the network address you have selected. (For example, select the network address 192.168.10 and allocate two host IP addresses: 192.168.10.1 and 192.168.10.254)
  - Specify 255.255.255.0 to net mask of the virtual IP address.
  - When you configure multiple virtual IP addresses, dummy virtual IP addresses may be required. For details, see “Preparing for using virtual IP resources” on page 691.
  - Private IP addresses are addresses for a closed network and they cannot be accessed using virtual IP address from outside of the network through internet providers.
  - Do not disclose path information of private IP addresses outside the organization.
  - Adjust the private IP addresses to avoid conflict with other address.

## Preparing for using virtual IP resources

If your cluster configuration satisfies the following conditions, you need to set a dummy virtual IP address which has same network address as a virtual IP address on each server.

- ◆ When multiple virtual IP resources exist in a cluster.
- ◆ Virtual IP resources whose network address and NIC alias name are same exist in a cluster.

---

**Note:** If a dummy virtual IP address cannot be configured, other virtual IP addresses assigned to the same NIC alias might be deleted by the OS when any virtual IP resource is deactivated.

---

A dummy virtual IP address should satisfy the following conditions:

- ◆ The IP address has a same network address as of a virtual IP resource, and is unique.
- ◆ The IP address can be prepared for each server constructing a cluster.
- ◆ The IP address is prepared for each NIC alias.

In the following settings, a dummy virtual IP address should be configured on each server.

- Virtual IP resource 1  
IP address 10.0.1.11/24  
NIC alias name eth1
- Virtual IP resource 2  
IP address 10.0.1.12/24  
NIC alias name eth1

For example, set a dummy virtual IP address as follows:

- Dummy virtual IP address of server1  
IP address 10.0.1.100/24  
NIC alias name eth1:0
- Dummy virtual IP address of server2  
IP address 10.0.1.101/24  
NIC alias name eth1:0

Configure the OS by the following procedure so that dummy virtual IP addresses are enabled at OS startup.

In the following procedure, eth1 of server 1 is set to 10.0.1.100/24 as an example.

1. Perform one of the following procedures according to your distribution.
  - For Novell SUSE LINUX Enterprise Server:

**Path**

`/etc/sysconfig/network/ifcfg-eth1-"MAC_address_of_eth1"`

**Setting information**

```
BOOTPROTO='static'
BROADCAST='10.0.0.255'
IPADDR='10.0.0.1'
MTU=''
NETMASK='255.255.255.0'
NETWORK='10.0.0.0'
IPADDR_1='10.0.1.100'
NETMASK_1='255.255.255.0'
NETWORK_1='10.0.1.0'
LABEL_1=1
REMOTE_IPADDR=''
STARTMODE='onboot'
UNIQUE='xxxx'
__nm_name='xxxx'
```

- For other than Novell SUSE LINUX Enterprise Server:
- Create a file on the following path, and add the setting information.

**Path**

`/etc/sysconfig/network-scripts/ifcfg-eth1:0`

**Setting information**

```
DEVICE=eth1:0
BOOTPROTO=static
BROADCAST=10.0.1.255
HWADDR=MAC_address_of_eth1
IPADDR=10.0.1.100
NETMASK=255.255.255.0
NETWORK=10.0.1.0
ONBOOT=yes
TYPE=Ethernet
```

2. Restart the OS.

Dummy virtual IP addresses are enabled after the OS restart. Configure server 2 in the same manner.



Follow the procedure below when the settings above is required due to the cluster configuration change.

1. Stop a cluster. For the procedure, see “Suspending EXPRESSCLUSTER Stopping the EXPRESSCLUSTER daemon” in Chapter 9, “Preparing to operate a cluster system” in the *Installation and Configuration Guide*.
2. Disable the cluster daemon. For the procedure, see “Suspending EXPRESSCLUSTER Disabling the EXPRESSCLUSTER daemon” in Chapter 9, “Preparing to operate a cluster system” in the *Installation and Configuration Guide*.
3. Change the settings above.
4. Restart the OS, and check that the settings are applied.
5. Enable the cluster daemon. For the procedure, see “Suspending EXPRESSCLUSTER Enabling the disabled EXPRESSCLUSTER daemon” in Chapter 9, “Preparing to operate a cluster system” in the *Installation and Configuration Guide*.
6. Modify the cluster configuration. For the procedure, see Chapter 7, “Modifying the cluster configuration data” in the *Installation and Configuration Guide*.

## Controlling path

To access to a virtual IP address from a remote LAN, path information of the virtual IP address must be effective to all routers on the path from the remote LAN to the LAN for cluster server. To be specific, the following condition must be satisfied:

- ◆ Routers on the cluster servers LAN interpret host RIP.
- ◆ Routers on the path from a cluster server to the remote server have the dynamic routing settings or information on the virtual IP address routes has configured as static routing settings.

## Requirement to use virtual IP address

### Environments where virtual IP address can be used

Virtual IP addresses can be accessed from the machines listed below. Virtual IP address mechanism functions properly even in a LAN where switching hubs are used. However, when a server goes down, TCP/IP that has been connected will be disconnected.

When using virtual IP addresses with a switching HUB that cannot be configured to create a host routing table by receiving host RIP, you need to reserve one new network address and configure virtual IP addresses so that the IP address of each server belongs to a different network address.

#### ◆ Cluster servers that belong to the same LAN which the server the virtual IP activates belongs to

Virtual IP addresses can be used if the following conditions are satisfied:

- Machines that can change the path by receiving RIP packets.
- Machines that can resolve the path information of a virtual IP address by accessing a router.

#### ◆ Cluster servers that belongs to the different LAN from which the server the virtual IP activates belongs to

Virtual IP addresses can be used if the following condition is satisfied:

- Machines that can resolve path information of the virtual IP address by accessing a router.

#### ◆ Clients that belongs to the same LAN which cluster servers belong to

Virtual IP addresses can be used if the following conditions are satisfied:

- Machines that can change the path by receiving RIP packets.
- Machines that can resolve the path information of a virtual IP address by accessing a router.

#### ◆ Clients on remote LAN

Virtual IP addresses can be used if the following condition is satisfied:

- Machines that can resolve path information of the virtual IP address by accessing a router.

## Notes on virtual IP resources

- ◆ Do not execute a network restart on a server on which virtual IP resources are active. If the network is restarted, any IP addresses that have been added as virtual IP resources are deleted.

The following rule applies to virtual IP addresses.

- ◆ If virtual IP resources are not inactivated properly (e.g. when a server goes down), the path information of virtual IP resources is not deleted. If virtual IP resources are activated with their path information not deleted, the virtual IP addresses cannot be accessed until their path information is reset by a router or a routing daemon.  
Thus, you need to configure the settings of a flush timer of a router or a routing daemon. For a flush timer, specify the value within the heartbeat timeout value. For details on the heartbeat timeout, see “Cluster properties Timeout tab” in Chapter 2 “Functions of the Builder” in this guide.
- ◆ MAC address of virtual NIC to which virtual IP is allocated.  
When the virtual IP resource fails over, the corresponding MAC address is changed because the MAC address of virtual NIC to which the virtual IP is allocated is the MAC address of real NIC.
- ◆ Source address of IP communication from the running server when the resource activation.  
The source address from the server is basically the real IP of the server even though the virtual IP resource has activated. When you want to change the source address to the virtual IP, the settings are necessary on the application.
- ◆ Routing protocol used  
If the routing protocol is set to “RIPver2,” the subnet mask for transmitted RIP packets is “255.255.255.255.”

## Displaying and changing the details of virtual IP resource

1. From the tree view on the left pane of the Builder, click the group icon where the virtual IP resources whose details you want to display and/or change belong.
2. The group resource list is displayed in the table view in the right pane of the window. Right-click the desired virtual IP resource name, click **Properties**, and then click **Details** tab.
3. On **Details** tab, you can display and/or change the settings by following the description below.

### Virtual IP resource details tab

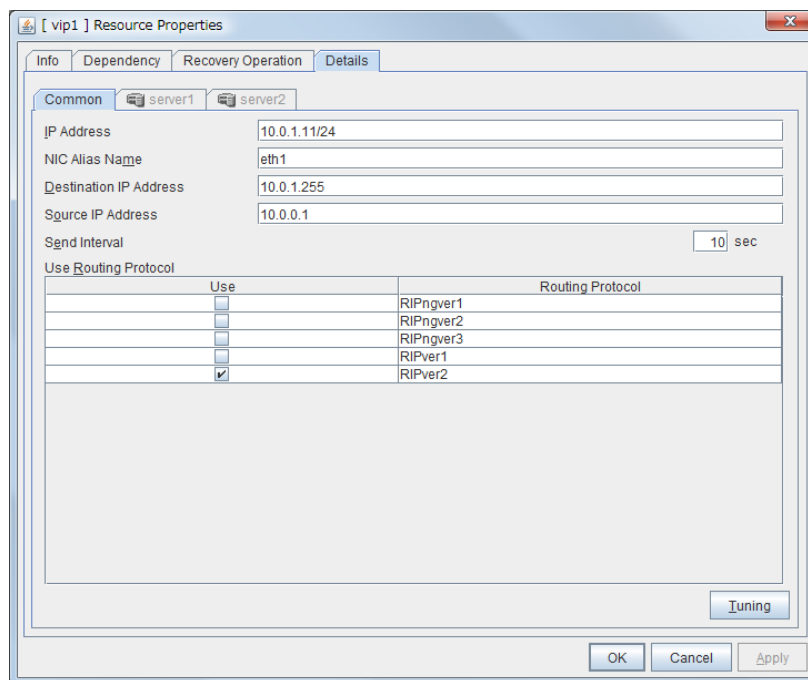

#### IP Address **Server Individual Setup**

Enter the virtual IP address to use. To specify a number of mask bits explicitly, specify the address followed by /number\_of\_mask\_bits. (For an IPv6 address, be sure to specify /number\_of\_mask\_bits.)

#### NIC Alias Name **Server Individual Setup**

Enter the NIC interface name that activates the virtual IP address to be used.

#### Destination IP Address **Server Individual Setup**

Enter the destination IP address of RIP packets. IPv4 specifies the broadcast address and IPv6 specifies the router IPv6 address.

#### Source IP Address **Server Individual Setup**

Enter the IP address to bind when sending RIP packets. Specify the actual IP address activated on NIC which activates the virtual IP address.

To use an IPv6 address, specify a link local address as the source IP address.

**Note:**

The source IP address should be set for individual servers, and set the actual IP address of each server. Virtual IP resources do not operate properly if a source address is invalid. In the **Common** tab, describes the source IP address of any server, other servers, please to perform the individual setting.

**Send Interval (1 to 30)** **Server Individual Setup**

Specify the send interval of RIP packets.

**Use Routing Protocol** **Server Individual Setup**

Specify the RIP version to use. For IPv4 environment, select RIPver1 or RIPver2. For IPv6 environment, select RIPngver1 or RIPngver2 or RIPngver3. You can select more than one routing protocols.

**Tuning**

Opens **Virtual IP resource Tuning Properties**. You can make the advanced settings for the virtual IP resources.

**Virtual IP Resource Tuning Properties****Parameter tab**

Detailed setting for virtual IP parameter is displayed.

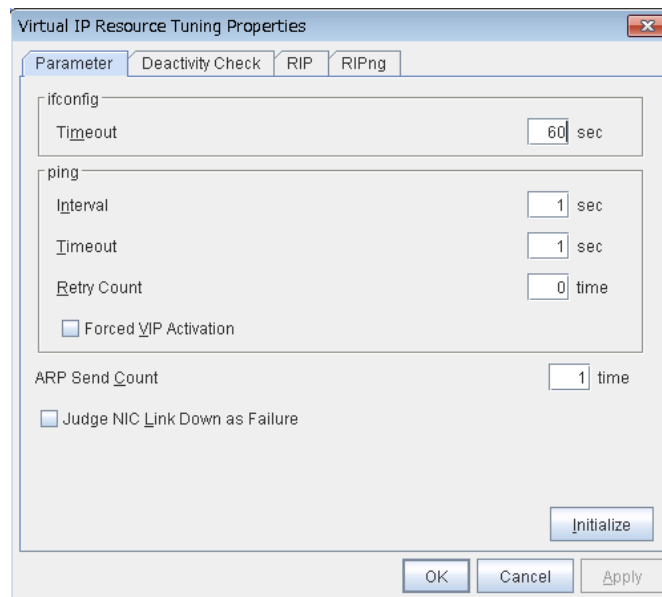
**ifconfig**

The following is the detailed settings on getting IP addresses and on the ifconfig command executed for the activation and/or deactivation of the virtual IP resource.

- ◆ **Timeout** 1 to 999  
Make the setting of the timeout of [ifconfig] command. This parameter is not available in an environment in which the [ifconfig] command cannot be used. Therefore, specify 60 seconds (default value for such an environment).

### ping

In this box, make detailed settings of the ping command used to check for any overlapped IP address before activating the virtual IP resource.

- ◆ Interval 0 to 999  
Specify the interval to issue the ping command in seconds.
- ◆ Timeout 0 to 999  
Specify the time-out for the ping command in seconds.  
When 0 is specified, the ping command is not run.
- ◆ Retry Count 0 to 999  
Specify how many retries of issuing the ping command are attempted.
- ◆ Forced VIP Activation  
Use this button to configure whether to forcibly activate the virtual IP address when an overlapped IP address is found using the ping command.
  - When the check box is selected  
Forcefully activate the virtual IP address.
  - When the check box is not selected  
Do not forcefully activate the virtual IP address.

### ARP Send Count 0 to 999

Specify how many times you want to send ARP packets when activating virtual IP resources.

If this is set to zero (0), ARP packets will not be sent.

### Judge NIC Link Down as Failure

Specify whether to check for an NIC Link Down before the virtual IP resource is activated. In some NIC boards and drivers, the required `ioctl()` may not be supported. To check the availability of the NIC Link Up/Down monitor, use the `[ethtool]` command provided by the distributor. For the check method using the `[ethtool]` command, see “Note on NIC Link Up/Down monitor resources” in “Understanding NIC Link Up/Down monitor resources” in Chapter 5 of this guide.

- When the check box is selected  
In the case of an NIC Link Down, the floating IP resource is not activated.
- When the check box is not selected  
Even in the case of an NIC Link Down, the floating IP resource is activated. This operation is the same as before.

### Initialize

Click **Initialize** to reset the values of all items to their default values.

### Deactivity Check tab

Detailed settings on deactivity check of virtual IP resource are displayed.

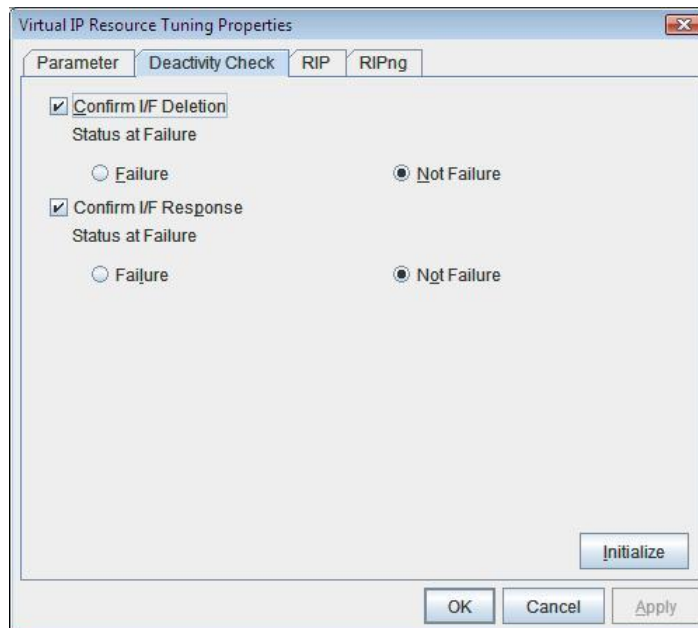

#### Confirm I/F Deletion

After deactivating the virtual IP, the cluster makes sure that the given virtual IP address disappeared successfully. Configure if failure is treated as the IP resource deactivity failure.

- ◆ Failure:  
Treats as a deactivity failure of a virtual IP resource.
- ◆ Not Failure:  
Does not treat as a deactivity failure of a virtual IP resource.

#### Confirm I/F Response

After deactivating a virtual IP, a cluster makes sure that the given virtual IP address cannot be accessed by the ping command. Configure reaching the virtual IP address by the ping command is treated as deactivity failure.

- ◆ Failure:  
Treats as a deactivity failure of a virtual IP resource.
- ◆ Not Failure:  
Do not treat as a deactivity failure of a virtual IP resource.

### RIP tab

Detailed settings on RIP of virtual IP resource are displayed.

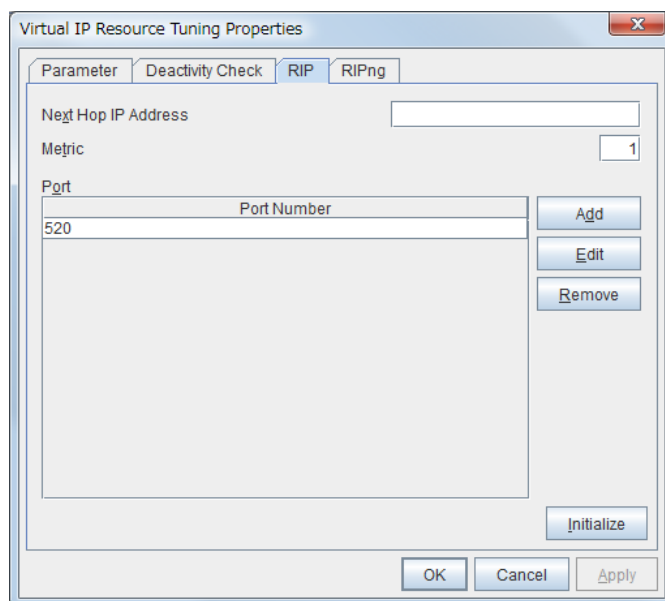

#### Next Hop IP Address

Enter the next hop address (address of the next router). Next hop IP address can be omitted. It can be specified for RIPver2 only. You cannot specify a netmask or prefix.

#### Metric (1 to 15)

Enter a metric value of RIP. A metric is a hop count to reach the destination address.

#### Port

On **Port Number**, a list of communication ports used for sending RIP is displayed.



**Add**

Add a port number used for sending RIP. Clicking this button displays the dialog box to enter a port number.

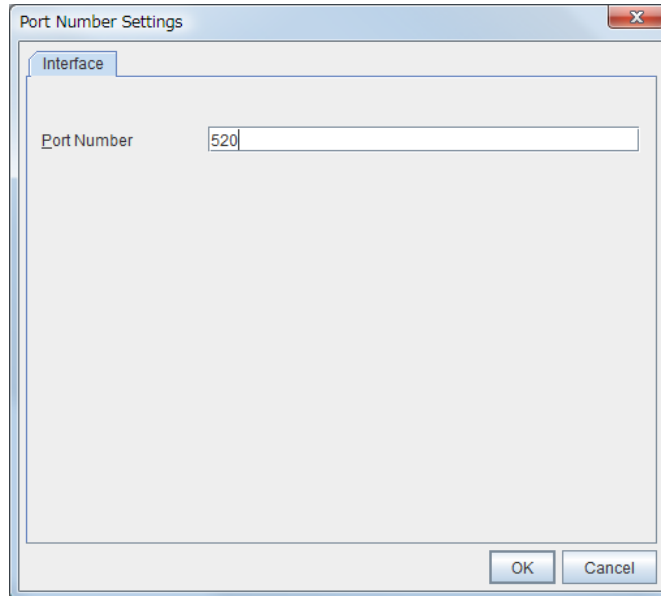
**Port Number**

Enter a port number to be used for sending RIP, and click **OK**.

**Edit**

A dialog box to enter a port number is displayed. The port selected in the **Port Number** is displayed. Edit it and click **OK**.

**Delete**

Click **Delete** to delete the selected port on the **Port Number**.

### RIPng tab

Detailed settings on RIPng of virtual IP resource are displayed.

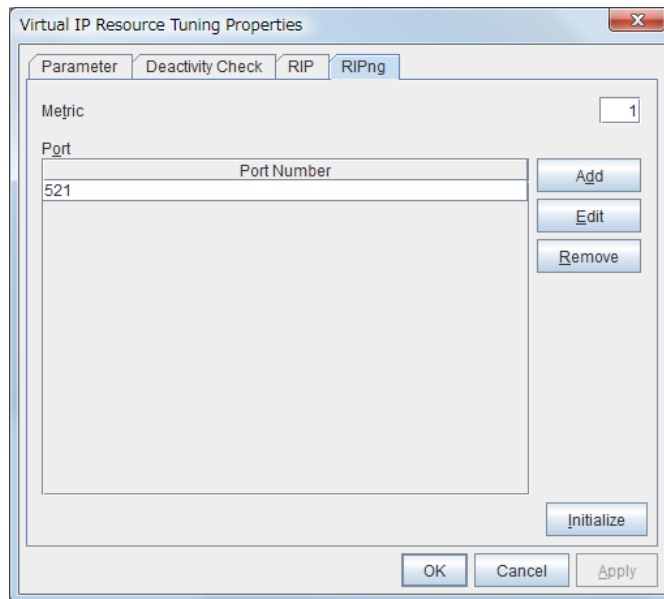

#### Metric (1 to 15)

Enter a metric value of RIPng. A metric is a hop count to reach the destination address.

#### Port

On **Port Number**, a list of ports used for sending RIPng is displayed.

#### Add

Add a port number used for sending RIPng. Clicking this button displays the dialog box to enter a port number.

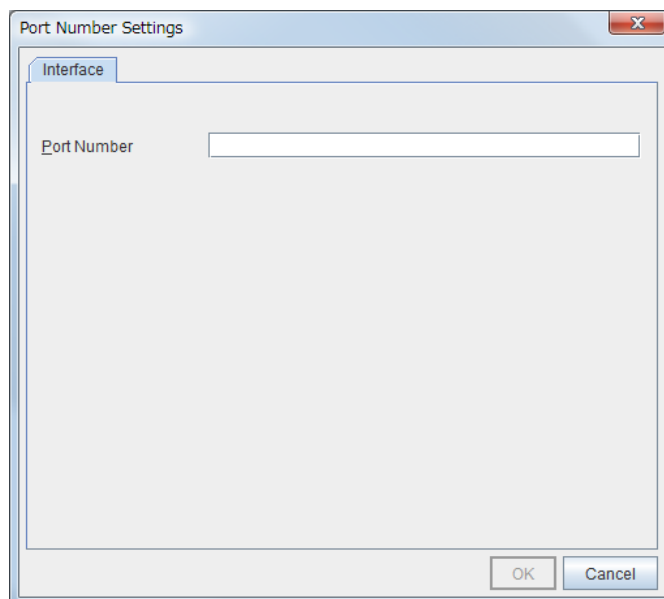

**Port Number**

Enter a port number to be used for sending RIPng, and click **OK**.

**Edit**

A dialog box to enter a port number is displayed. The port selected in the **Port Number** is displayed. Edit it and click **OK**.

**Delete**

Click **Delete** to delete the selected port on the **Port Number**.

## Displaying the virtual IP resource properties with the WebManager

1. Start the WebManager.
2. Click an object for virtual IP resource  in the tree view. The following information is displayed in the list view.

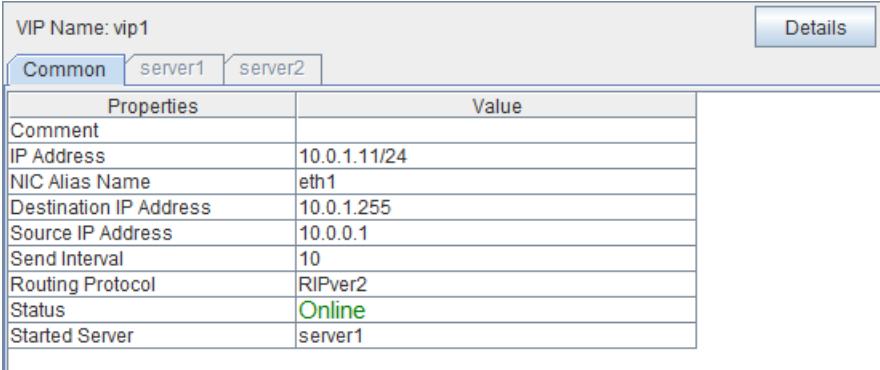

VIP Name: vip1		Details
Common		server1
server2		
Properties	Value	
Comment		
IP Address	10.0.1.11/24	
NIC Alias Name	eth1	
Destination IP Address	10.0.1.255	
Source IP Address	10.0.0.1	
Send Interval	10	
Routing Protocol	RIPver2	
Status	Online	
Started Server	server1	

Comment:	Comment for the virtual IP resource
IP Address:	IP address of the virtual IP resource
NIC Alias Name:	NIC Alias Name of the virtual IP resource
Destination IP Address:	Destination IP Address of RIP for virtual IP resource
Source IP Address:	Source IP Address of RIP for virtual IP resource
Send Interval:	Interval of RIP sending for virtual IP resource
Routing Protocol:	RIP version for virtual IP resource
Status:	Status of the virtual IP resource
Started Server:	Server name

If you click **Details**, the following information is displayed in the pop-up dialog.

Properties	Value
Name	vip1
Type	vip
Failover Threshold	1
Retry Count at Activation Failure	1
Final Action at Activation Failure	No operation (not activate next resource)
Execute Script before Final Action	Off
Retry Count at Deactivation Failure	1
Final Action at Deactivation Failure	Stop the cluster daemon and shutdown OS
Execute Script before Final Action	Off
Depended Resources	
Ping Timeout (sec)	1
Ping Retry Count	0
Ping Interval (sec)	1
VIP Force Activation	Off
ARP Send Count	1
Ifconfig Timeout (sec)	60
Ifconfig Status at Failure	Not Failure
Ping Status at Failure	Not Failure
RIP Next Hop IP Address	
RIP Metric	1
RIP Port Number	520
RIPng Metric	1
RIPng Port Number	521

Name:	Virtual IP resource name
Type:	Resource type
Failover Threshold:	The number of failovers to be made at detection of an error
Retry Count at Activation Failure:	The number of times activation is retried when an activation error is detected
Final Action at Activation Failure:	Final action at an activation error
Execute Script before Final Action:	Whether or not script is executed upon activation failure
Retry Count at Deactivation Failure:	The number of times deactivation is retried when a deactivation error is detected
Final Action at Deactivation Failure:	Final action when a deactivation error is detected
Execute Script before Final Action:	Whether or not script is executed upon deactivation failure
Dependent Resources:	Dependent resources
Ping Timeout (sec):	ping timeout
Ping Retry Count:	ping retry count
Ping Interval (sec):	ping interval
VIP Forced Activation:	Forcibly activate the virtual IP resource
ARP Send Count:	ARP send count
Ifconfig Timeout (sec) :	Ifconfig timeout
Ifconfig Status at Failure:	Status of inactivation check ifconfig error
Ping Status at Failure:	Status of inactivation check ping error
RIP Next Hop Ip Address:	Next hop address of RIP
RIP Metric:	RIP metric
RIP Port Number:	RIP port number
RIPng Metric:	RIPng metric
RIPng Port Number:	RIPng port number

# Understanding mirror disk resources

## Dependencies of mirror disk resource

By default, this function depends on the following group resource type.

Group resource type
Floating IP resource
Virtual IP resource
AWS elastic ip resource
AWS virtual ip resource
Azure probe port resource

## Mirror disk

### Mirror disk

Mirror disks are a pair of disks that mirror disk data between two servers in a cluster.

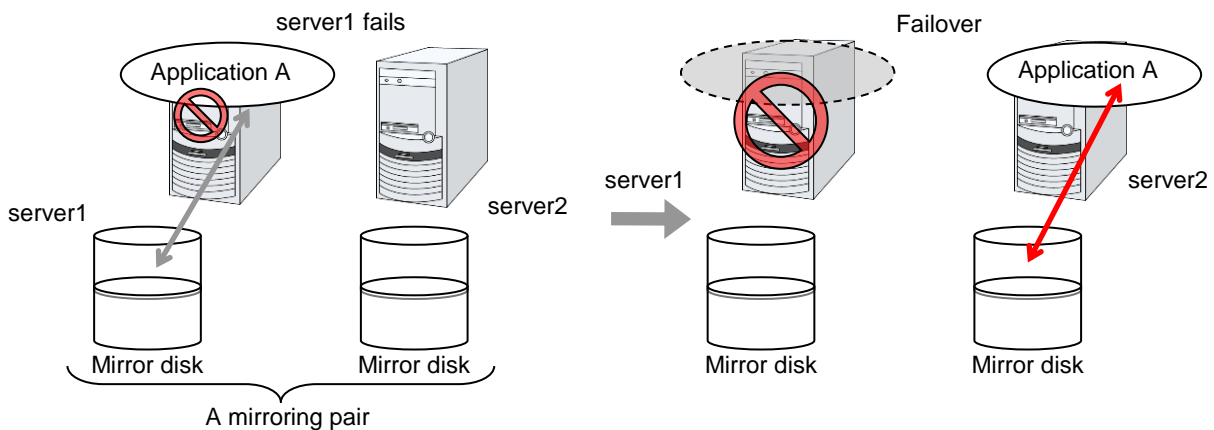

### Data partition

Partitions where data to be mirrored (such as application data) is stored are referred to as data partitions. Allocate data partitions as follows:

- ◆ Data partition size  
The size of data partition should be 1GB or larger but smaller than 1TB.  
(Less than 1TB size is recommended from the viewpoint of the construction time and the restoration time of data.)
- ◆ Partition ID  
83(Linux)
- ◆ If Execute initial mkfs is selected in the cluster configuration information, a file system is automatically created when a cluster is generated.
- ◆ EXPRESSCLUSTER is responsible for the access control (mount/umount) of file system.  
Do not configure the settings that allow the OS to mount or unmount a data partition.

### Cluster partition

Dedicated partitions used in EXPRESSCLUSTER for mirror partition controlling are referred to as cluster partition.

Allocate cluster partitions as follows:

- ◆ Cluster partition size  
10 MB or more. Depending on the geometry, the size may be larger than 10 MB, but that is not a problem.
- ◆ Partition ID  
83(Linux)
- ◆ A cluster partition and data partition for data mirroring should be allocated in a pair.
- ◆ You do not need to make the file system on cluster partitions.
- ◆ EXPRESSCLUSTER performs the access control of the file system (`mount/unmount`) as a device to mount the mirror partition device. Thus, do not configure the settings to mount or unmount the cluster partition on the OS side.

### Mirror Partition Device (`/dev/NMPx`)

One mirror disk resource provides the file system of the OS with one mirror partition. If a mirror disk resource is registered to the failover group, it can be accessed from only one server (it is generally the primary server of the resource group).

Typically, the mirror partition device (`dev/NMPx`) remains invisible to users (AP) because they perform I/O via a file system. The device name is assigned so that the name does not overlap with others when the information is created by the Builder.

- ◆ EXPRESSCLUSTER is responsible for the access control (`mount/unmount`) of file system. Do not configure the settings that allow the OS to mount or unmount a data partition.  
  
Mirror partition's (mirror disk resource's) accessibility to applications is the same as switching partition (disk resources) that uses shared disks.
- ◆ Mirror partition switching is done for each failover group according to the failover policy.

### Mirror disk connect

Maximum of two mirror disk connects can be registered per mirror disk resource.

- ◆ When two mirror disk connects are registered, operations such as switching etc. are as follows:
  - The paths used to synchronize mirror data can be duplicated. By setting this, mirror data can be synchronized even when one of the mirror disk connects becomes unavailable due to such as disconnection.
  - The speed of mirroring does not change.
  - When mirror disk connects switch during data writing, mirror break may occur temporarily. After switching mirror disk connects completes, differential mirror recovery may be performed.
  - When mirror disk connects switch during mirror recovery, mirror recovery may be suspended. If the setting is configured so that the automatic mirror recovery is performed, mirror recovery automatically resumes after switching mirror disk connects completes. If the setting is configured so that the automatic mirror recovery is not performed, you need to perform mirror recovery again after switching mirror disk

connects completes.

For the mirror disk connect settings, see “Cluster properties “Interconnect tab” in Chapter 2 “Functions of the Builder” in this guide.

◆ Disk type

For the supported disk types, see “Hardware Supported disk interfaces” in Chapter 3, “Installation requirements for EXPRESSCLUSTER” in the *Getting Started Guide*.

◆ Disk partition

- It is possible to allocate a mirror disk partition (cluster partition, data partition) on a disk, such as root partition or partition, where the OS is located
  - When maintainability at a failure is important:  
It is recommended to allocate a disk for mirror which is not used by the OS (such as root partition, swap partition).
  - If LUN cannot be added due to H/W RAID specifications:  
If you are using hardware/RAID preinstall model where the LUN configuration cannot be changed, you can allocate a mirror partition (cluster partition, data partition) in the disk where the OS (root partition, swap partition) is located.

Example: Adding a SCSI disk to both servers to create a pair of mirroring disks.

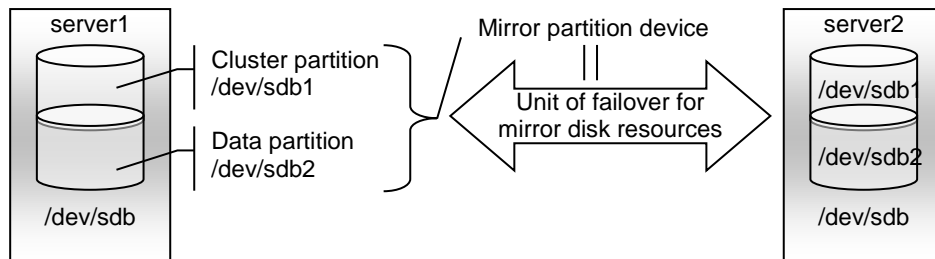

Example: Using available area of the IDE disks of both servers on which OS of is stored to create a pair of mirroring disks.

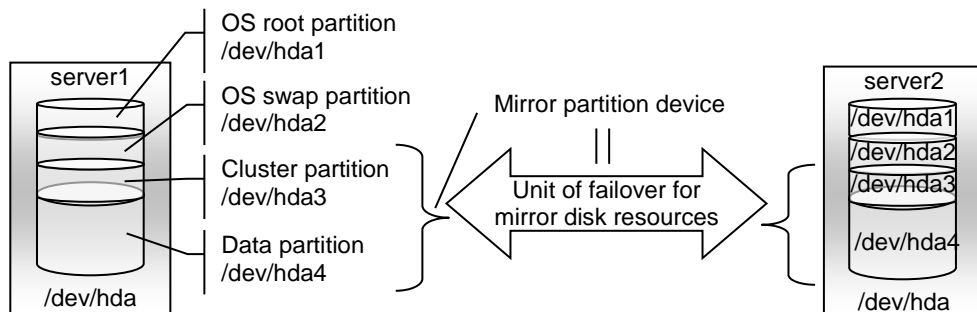



◆ Disk allocation

You may use more than one disk for mirror disk. You may also allocate multiple mirror partition devices to a single disk.

Example: Adding two SCSI disks to both servers to create two pairs of mirroring disks.

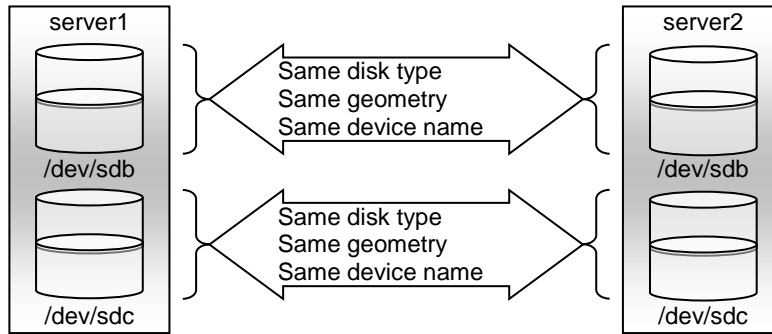

- Allocate a cluster partition and a data partition in a pair on a single disk.
- You may not use two or more added disks as one for a data partition and another for a cluster partition.

Example: Adding a SCSI disk for both servers to create two mirroring partitions.

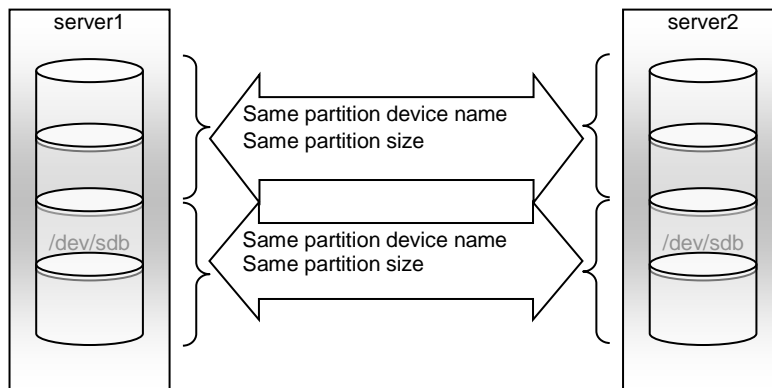

## Understanding mirror parameters

### Mirror Data Port Number

Set the TCP port number used for sending and receiving mirror data between servers. It needs to be configured for individual mirror disk resources.

The default value is displayed when a mirror disk resource is added in Builder based on the following condition:

- A port number of 29051 or later which is unused and the smallest

### Heartbeat Port Number

Set the port number that a mirror driver uses to communicate control data between servers. It needs to be configured for individual mirror disk resources.

The default value is displayed when a mirror disk resource is added in Builder based on the following condition:

- A port number of 29031 or later which is unused and the smallest

### ACK2 Port Number

Set the port number that a mirror driver uses to communicate control data between servers. It needs to be configured for individual mirror disk resources.

The default value is displayed when a mirror disk resource is added in Builder based on the following condition:

- A port number of 29071 or later which is unused and the smallest

### The maximum number of request queues

Configure the number of queues for I/O requests (write requests) from the higher layer of the OS to the mirror disk driver. If a larger value is selected, the write performance will improve but more physical memory will be required. If a smaller value is selected, less physical memory will be used but the write performance may be lowered.

Note the following when setting the number of queues:

- ◆ The improvement in the performance is expected when a larger value is set under the following conditions:
  - Large amount of physical memory is installed on the server and there is plenty of available memory.
  - The performance of the disk I/O and that of the network communication are both high.
- ◆ It is recommended to select a smaller value under the conditions:
  - Small amount of physical memory is installed on the server.
  - I/O performance of the disk is low.
  - “alloc\_pages: 0-order allocation failed (gfp=0x20/0)” is entered to the system log of the OS.
  - The synchronization mode is set to **Asynchronous** and a larger number is set in **Number of Queues** for mirror data transmission, but the maximum number of queues is soon reached because the network is slow, causing mirroring to be interrupted (mirror break). (When it does not matter if the write performance is degraded.)

**Connection Timeout**

This timeout is used for the time passed waiting for a successful connection between servers when recovering mirror or synchronizing data.

**Send timeout**

This timeout is used:

- ◆ For the time passed waiting for the write data to be completely sent from the active server to the standby server from the beginning of the transmission at mirror return or data synchronization.

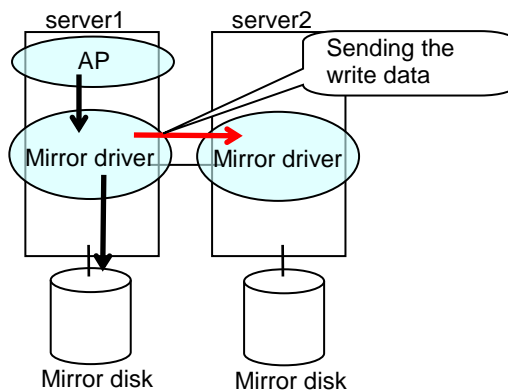

In detail, this timeout is to wait for write data to be completely stored in the send buffer of a network (TCP) once data storing begins. If the TCP buffer is full and there is no free space, a timeout occurs.

- ◆ For the time interval for checking if the ACK send (in which the active server notifies the standby server of write completion) is necessary.

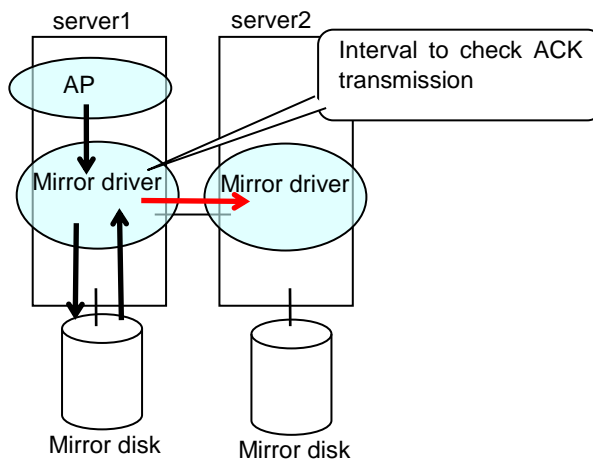

**Receiving timeout**

- ◆ This timeout is used for the time passed waiting for the standby server to completely receive the write data from the active server from the beginning of the transmission.

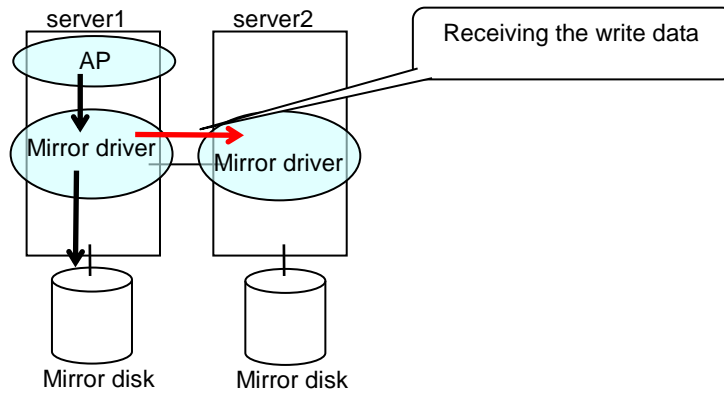

**Ack timeout**

- ◆ This timeout is used for the time passed waiting for the active server to receive the ACK notifying the completion of write once the active server begins sending write data to the standby server.

If the ACK is not received within the specified timeout time, the difference information is accumulated to the bitmap for difference on the active server.

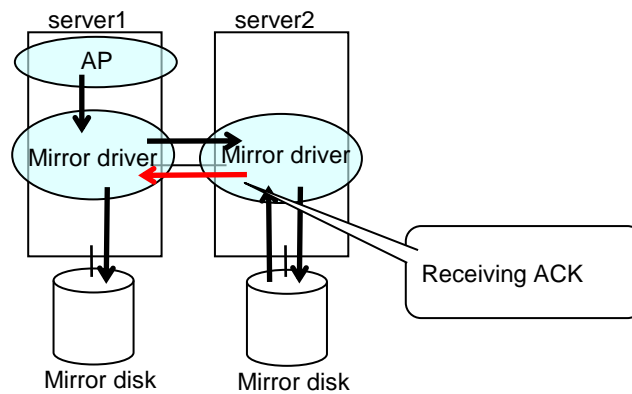

If you use the synchronous mode, a response to an application might wait until receiving the ACK or until it's timeout.

If you use the asynchronous mode, a response to an application is returned after writing to the active server's disk. (This response does not wait for ACK).

- ◆ This timeout is used for the time passed waiting for the standby server to receive the ACK from the active server after the standby server completely sent the ACK notifying the completion of write.  
If the ACK for the active server is not received within the specified timeout time, the difference information is accumulated to the bitmap for difference on the standby server.

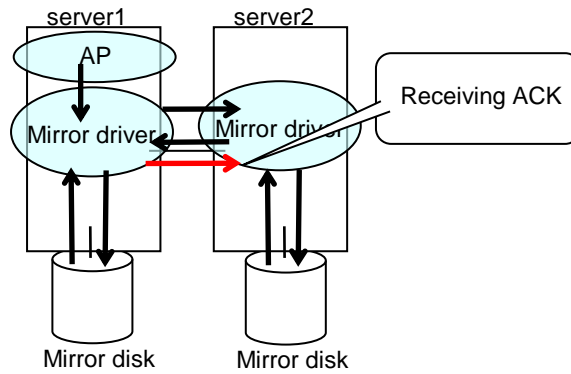

- ◆ This timeout is used for the time passed waiting for the copy source server to receive the ACK notifying completion from the copy destination server after it began the data transmission when recovering mirror.

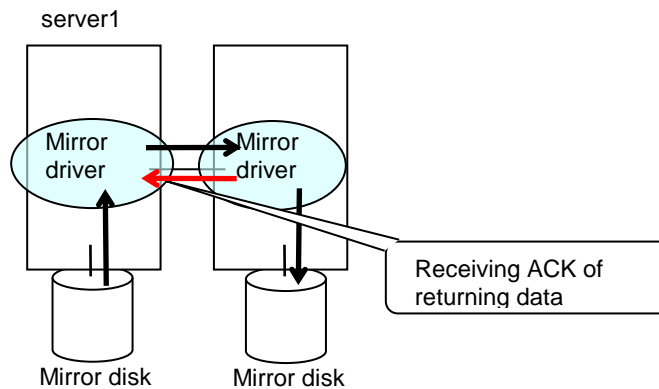

When the sending amount of the recovery data reaches the Recovery Data Size, 1 ACK is returned (Recovery Data Size is described below.)  
Therefore when the Recovery Data Size becomes larger, sending becomes more efficient.  
But if an ACK timeout occurred, re-send data size also becomes larger.

**Heartbeat Interval (1 to 600)**

Heartbeat interval (sec) for checking the soundness of the mirror disk connect between the mirror drivers of two servers. Use the default whenever possible.

**ICMP Echo Reply Receive Timeout (1 to 100)**

Value used for heartbeat that is performed to check the soundness of the mirror disk connect between the mirror drivers of two servers. The maximum wait time from when ICMP Echo Request is sent until ICMP Echo Reply is received from the destination server. If ICMP Echo Reply is not received even if this timeout elapses, the reception is repeated for up to the ICMP Echo Request retry count, explained later. Use the default whenever possible.

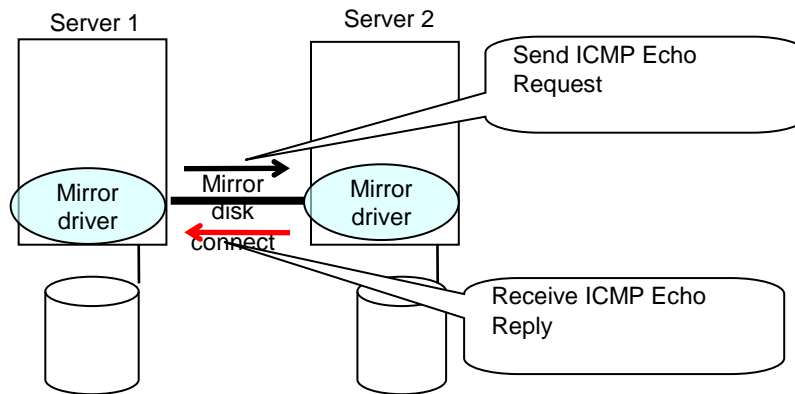
**ICMP Echo Request Retry Count (1 to 50)**

Enter how many times you want to retry at the maximum to send ICMP Echo Request if ICMP Echo Reply from the destination server to ICMP Echo Request cannot be received before the ICMP Echo Reply receive timeout. Use the default whenever possible.

Adjustment between the ICMP Echo Reply receive timeout and ICMP Echo Request retry count.

You can adjust the sensitivity that determines mirror disk connect disconnection by adjusting the ICMP Echo Reply receive timeout and ICMP Echo Request retry count.

- ◆ Increasing the value
  - Case in which a network delay occurs in a remote location
  - Case in which a temporary failure occurs in a network
- ◆ Decreasing the value
  - Case in which the time for detecting a network failure is to be reduced

**Bitmap Update Interval**

Information to be written to the bit map for difference is temporarily accumulated in memory, and is written to the cluster partition at regular intervals. This interval is used for the standby server to check whether this is information to write to the bit map as well as to perform a write.

### Initial Mirror Construction

Specify if configure initial mirroring<sup>4</sup> when activating cluster for the first time after the cluster is created.

- ◆ Execute the initial mirror construction

An initial mirroring is configured when activating cluster for the first time after the cluster is created.

The time that takes to construct the initial mirror is different from ext2/ext3/ext4 and other file systems.

- ◆ Do not execute initial mirror construction

Does not configure initial mirroring after constructing a cluster.

Before constructing a cluster, it is necessary to make the content of mirror disks identical without using EXPRESSCLUSTER.

### Initial mkfs

Specify if initial file creation in the data partition of the mirror disk is configured when activating cluster for the first time after the cluster is created.

- ◆ Execute initial mkfs

The first file system is created when activating cluster for the first time immediately after the cluster is created.

- ◆ Do not execute initial mkfs

Does not create a first file system to the data partition in the mirror disk when activating cluster for the first time immediately after the cluster is created.

You can configure the settings so that the initial mkfs setting is not executed when a file system has been set up in the data partition of the mirror disk and contains data to be duplicated, which does not require file system construction or initialization by mkfs.

The mirror disk partition<sup>5</sup> configuration should fulfill mirror disk resource requirements.

If **Does not execute initial mirror construction** is selected, **Execute initial mkfs** cannot be chosen. (Should mkfs be performed for the active and standby data partitions, even immediately after mkfs is performed, differences will arise between the active data partition and standby data partition for which mkfs has been executed. Therefore, when initially executing mkfs, initial mirror construction (copying of the active data partition and the standby data partition) is also required. If [Execute initial mirror construction] is selected, [Execute initial mkfs] can be chosen.)

<sup>4</sup> Regardless of the existence of the FastSync Option, the entire data partition is copied.

<sup>5</sup> There must be a cluster partition in a mirror disk. If you cannot allocate a cluster partition when the single server disk is the mirroring target, take a backup and allocate the partition.

### Number of Queues

In the **Asynchronous** mode, specify the maximum number of queues in which write requests to the remote disk are held. For details on asynchronous mode setting, see “Displaying and changing the details of mirror disk resource” on page 731.

In cases such as when a slow network is used or if the amount of data requiring transmission (synchronization) increases as the amount written to the mirror increases, those data waiting for transmission (waiting for synchronization to be complete) are accumulated in these queues. Then, if the network speed becomes fast or if the amount of data transmitted (synchronized) decreases along with reduced writes to the mirror, data in queues waiting for transmission are transmitted. In this way, queues are used to absorb the increase and decrease in written data and the network speed change and to transmit data to the network.

If a larger value is set for the number of queues to absorb the increase and decrease in synchronous data, usually, the maximum time until synchronization is complete (Ack timeout) should also be set to a larger value.

If the number of data units waiting for synchronization to be complete exceeds the maximum number of queues, then mirroring will be interrupted (mirror break).

By setting a larger maximum number of queues, you can increase the amount of data that can be buffered, but more memory space will be used. For information on the required memory size, see “Chapter 3 Installation requirements for EXPRESSCLUSTER” – “Software” – “Required memory and disk size” in the *Getting Started Guide*.

In the case that the maximum number of queues is too large, if a synchronization timeout (Ack timeout) or a mirror communication break occurs while writing a large amount of data, an enormous volume of queue processes will arise at a time, possibly leading to extremely high load.

### Rate limitation of Mirror Connect

In the **Asynchronous** mode, the server tries to transfer data that has been temporarily queued to the standby server as quickly as possible. For this reason, if the channel for mirror disk connect is used for other applications, the communication band may become busy, hindering other communications.

In this case, by imposing bounds on the communication band for mirror connect communication, the impact on other communications can be reduced.

If, however, the communication band for mirror disk connect is smaller than the average amount of data to be written to the mirror disk, the queued data cannot be fully transferred to the standby server, and at last the maximum number of queues is reached, causing mirroring to interrupt (mirror break). The bandwidth should be large enough to allow data to be written into the business application.

---

### Note:

This function imposes a limit on the communication band by having a maximum one-second pause when the total amount of data to be transferred per second exceeds the configured value. If the amount of data to be written to the disk at one time exceeds the configured value, the expected level of performance may not be achieved. For example, when the amount of data to be transferred to a copy of a mirror disk at one time is 64 KB, even if you set a communication band limit of 64 KB or less per second, the actual amount of communication during copy can be greater than the configured value.

---



### Compress Data

Specify whether to compress mirror synchronous data (in the case of **Asynchronous** mode) or mirror recovery data before transmission. If a slow network is used, compressing transmission data can reduce the amount of data to be transmitted.

---

#### Note:

Compression may increase the CPU load at data transmission.

In a slow network, compression reduces the amount of data transmitted, so a reduction in time can be expected compared to uncompressed data. Conversely, in a fast network, increases in compression processing time as well as load are more noticeable than a reduction in transfer time, so a reduction in time might not be expected.

If most of data has a high compression efficiency, compression reduces the amount of data transmitted, so a reduction in time can be expected compared to uncompressed data. Conversely, if most of data has a low compression efficiency, not only the amount of data transmitted is not reduced, but also the compression processing time and load increase, in which case a reduction in time might not be expected.

---

### Mirror agent send time-out

Time-out for the mirror agent waiting to complete processing data after sending a request to the other server.

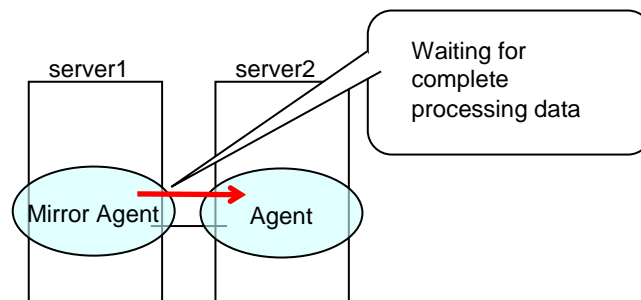

**Mirror agent receiving time-out**

Time-out for the mirror agent waiting to start receiving data after the mirror agent creates a communication socket with the other server.

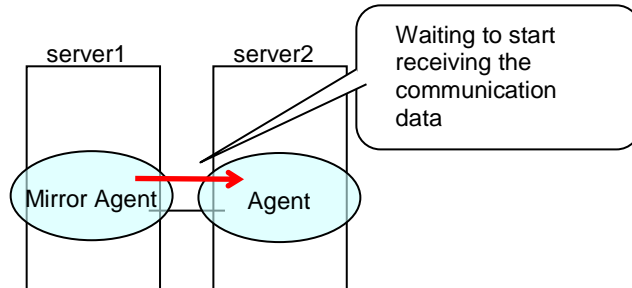
**Recovery Data Size** 64 to 32768

Specify the size of data in mirror recovery between two servers in one processing. The default size is used in general.

- ◆ Specify a larger size
  - It takes less time to completely process mirror recovery because the number of data exchanges between two servers decreases.
  - During mirror recovery, disk performance may degrade. (This is because, if the disk read range for mirror recovery data and the disk write range for a file system overlap, access is excluded and a wait occurs until the first processing is complete. In a slow network environment, if there is a large amount of recovery data, a single data transfer for mirror recovery will take more time. If a normal disk access for mirror data and this data transfer range for mirror recovery overlap, disk access is awaited until the transfer is complete. This may lead to degraded disk performance. Therefore, specify a smaller size, especially for a slow network environment.)
- ◆ Specify a smaller size
  - Sending/receiving data between two servers gets segmented and the possibility for a timeout to occur is decreased with a slow network speed or a high server load.
  - Because the number of exchanges between two servers increases, mirror recovery takes more time, especially in a network where delay occurs easily.

## Examples of mirror disk construction

If you are using a disk that has been used as a mirror disk in the past, you must format the disk because old data exists in its cluster partition. For the initialization of a cluster partition, refer to the *Installation and Configuration Guide*.

- ◆ Execute the initial mirror construction  
Executing initial mkfs

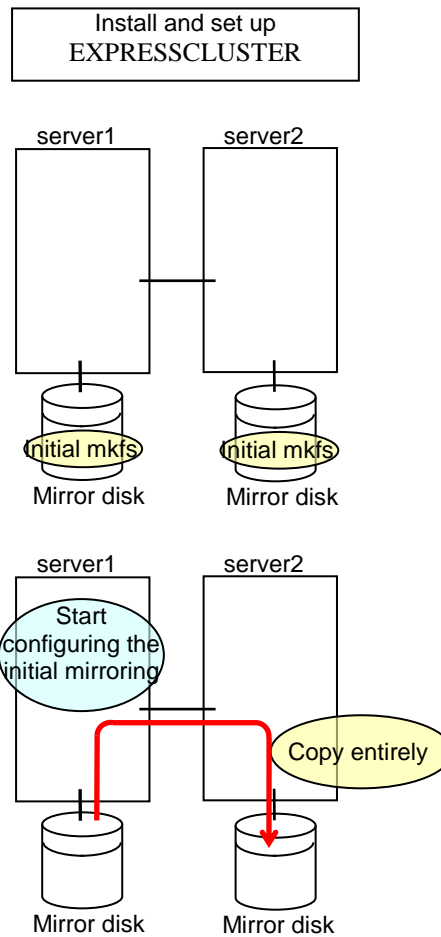

- ◆ Execute the initial mirror construction  
Not executing initial mkfs

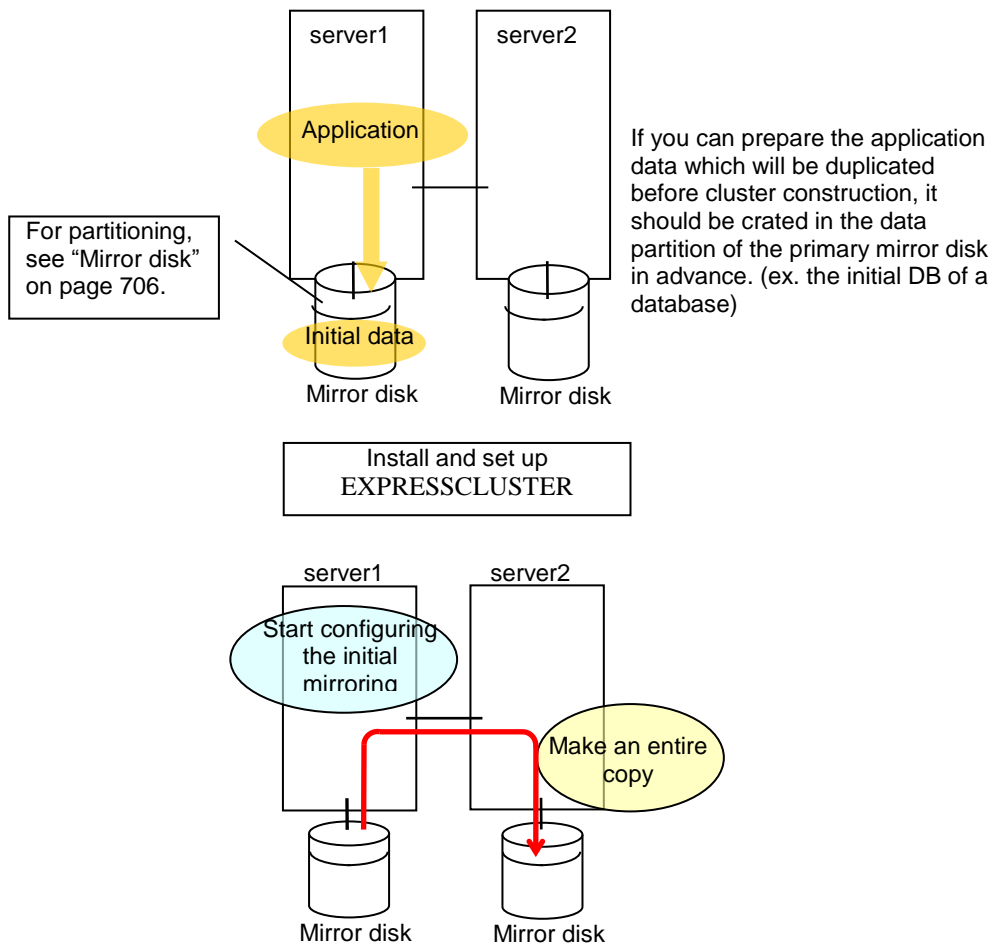

- ◆ Do not execute initial mirror construction  
Not executing initial mkfs

The following is an example of making the mirror disks of both servers identical. (This cannot be done after constructing the cluster. Be sure to perform this before the cluster construction.)

**Example 1**

Copying partition images of a disk

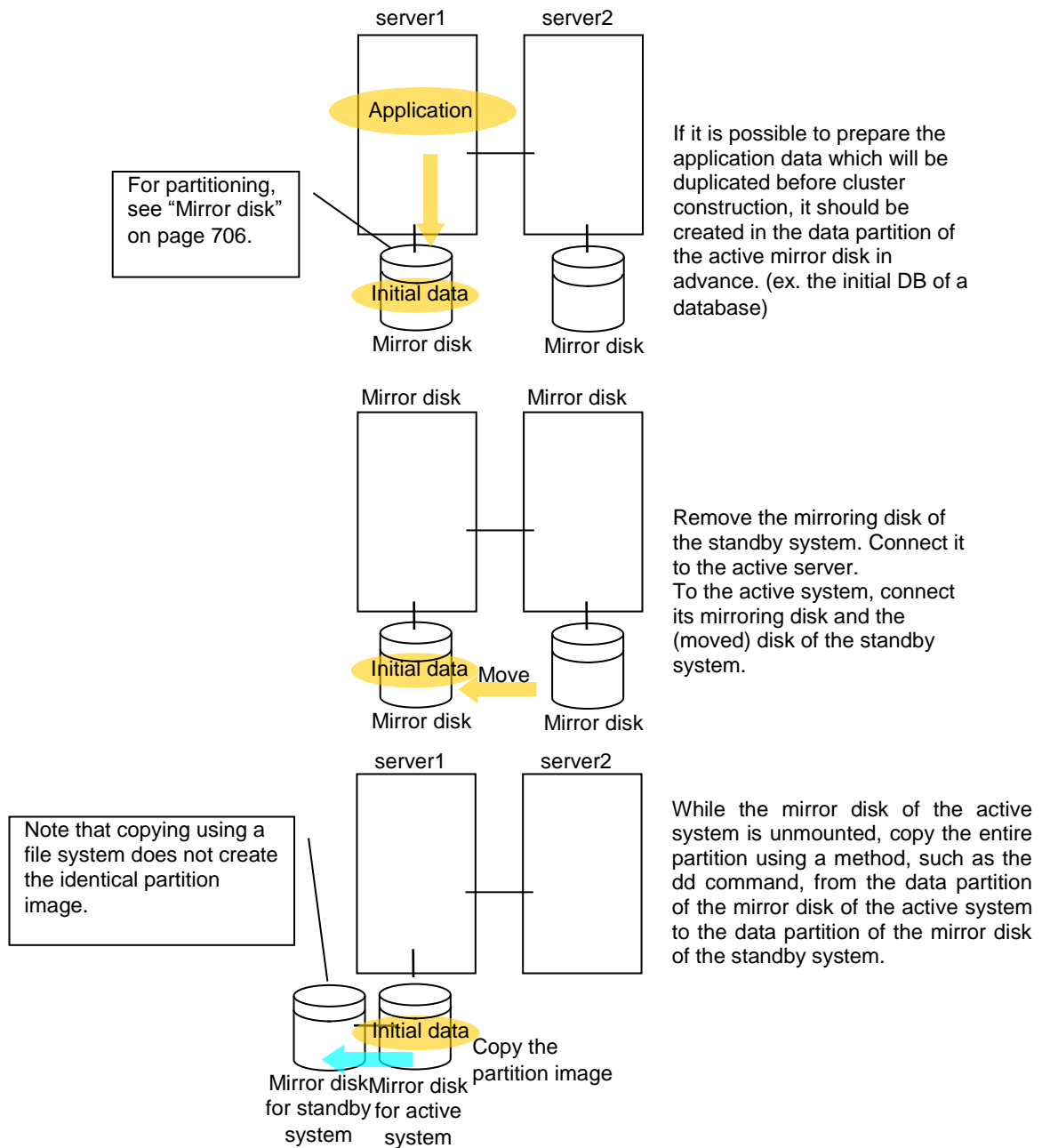

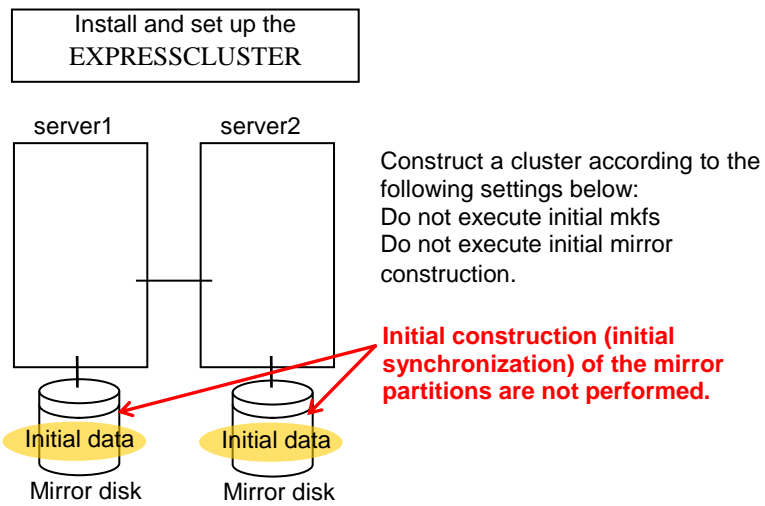
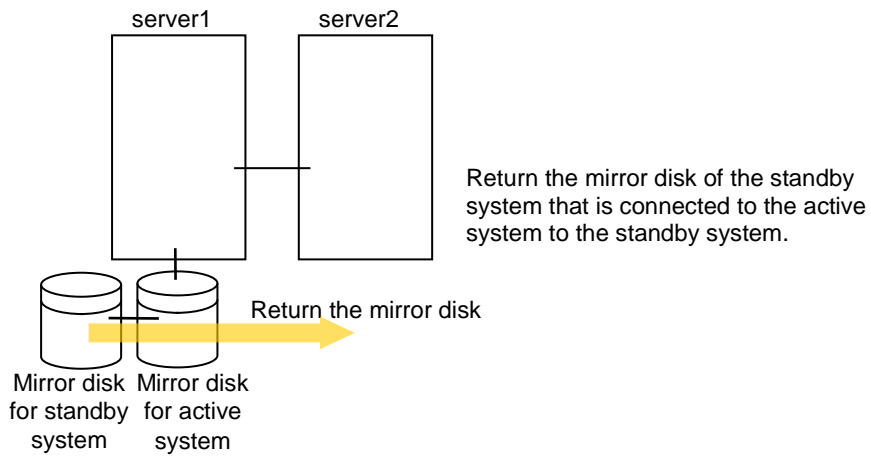

**Example 2**

Copying by a backup device

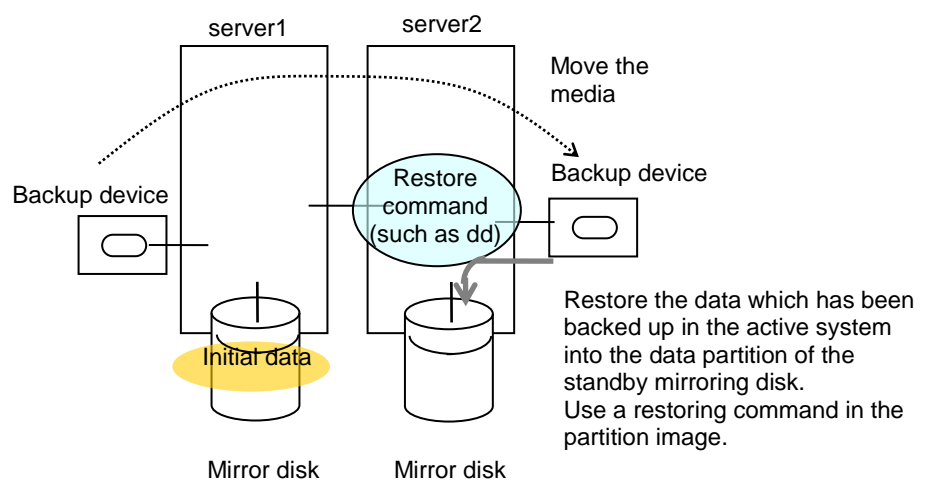
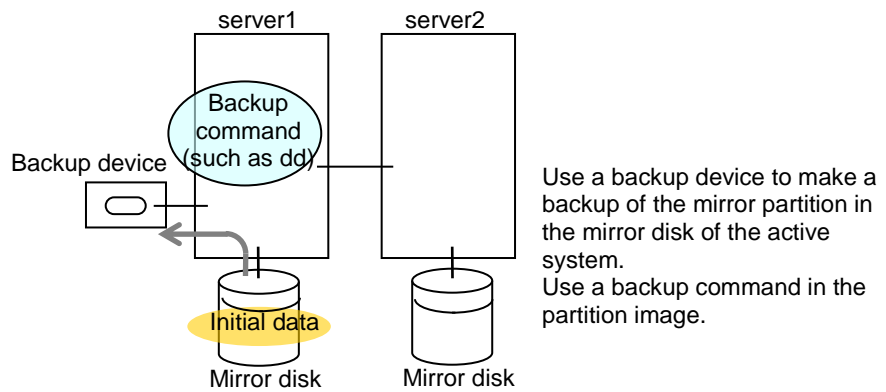
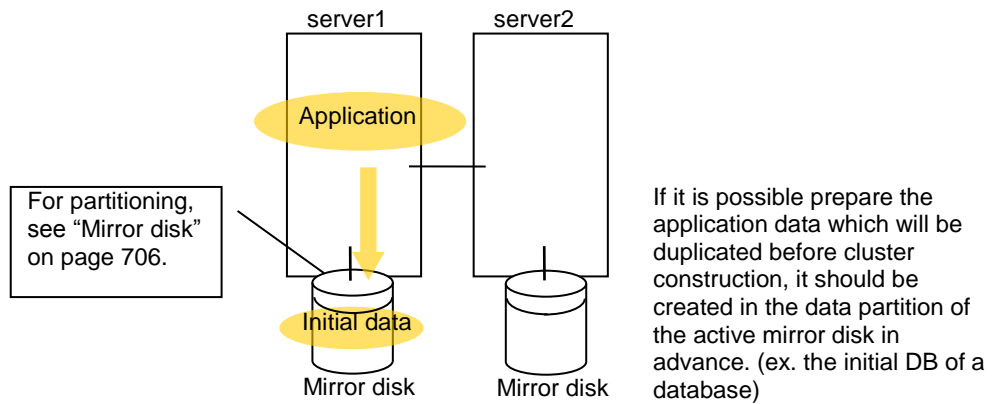

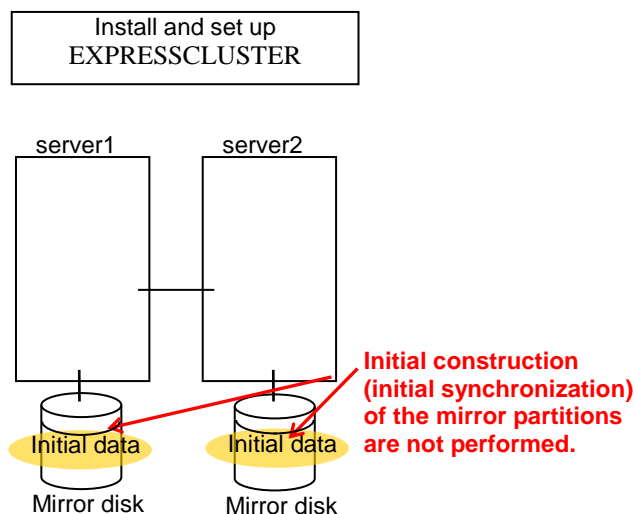

## Notes on mirror disk resources

- ◆ If both servers cannot access the identical partitions under the identical device name, configure the server individual setting.
- ◆ If **Mount/Unmount Exclusion** is selected on the **Exclusion** tab in **Cluster Properties**, activation/deactivation of mirror resource may take time because mount/umount is performed exclusively to disk resource, VxVM volume resource, NAS resource, and mirror resource in the same server.
- ◆ When specifying path including symbolic link for mount point, Force Operation cannot be done even if it is chosen as operation in Detecting Failure. Similarly, if a path containing “//” is specified, forced termination will also fail.
- ◆ Disks using stripe set, volume set, mirroring, stripe set with parity by Linux md cannot be specified for the cluster partition and data partition.
- ◆ Volumes by Linux LVM can be specified for the cluster partition and data partition. (X3.1.3-1 or later)  
For SuSE Linux, volumes by LVM or MultiPath cannot be used for the cluster partition or data partition.
- ◆ Mirror disk resources (mirror partition devices) cannot be the targets of stripe set, volume set, mirroring, stripe set with parity by Linux md or LVM.
- ◆ When the geometries of the disks used as mirror disks differ between the servers:
 

The size of a partition allocated by the `fdisk` command is aligned by the number of blocks (units) per cylinder.

Allocate data partitions to achieve the following data partition size and direction of the initial mirror construction.

### Source server ≤ Destination server

“Source server” refers to the server with the higher failover policy in the failover group to which a mirror resource belongs.

“Destination server” refers to the server with the lower failover policy in the failover group to which a mirror resource belongs.

If the data partition sizes differ significantly between the copy source and the copy destination, initial mirror construction may fail. Be careful, therefore, to secure data partitions of similar sizes.



Make sure that the data partition sizes do not cross over 32GiB, 64GiB, 96GiB, and so on (multiples of 32GiB) on the source server and the destination server. For sizes that cross over multiples of 32GiB, initial mirror construction may fail.

Examples)

Combination	Data partition size		Description
	On server 1	On server 2	
OK	30GiB	31GiB	OK because both are in the range of 0 to 32GiB.
OK	50GiB	60GiB	OK because both are in the range of 32GiB to 64GiB.
NG	30GiB	39GiB	Error because they are crossing over 32GiB.
NG	60GiB	70GiB	Error because they are crossing over 64GiB.

- ◆ Do not use the O\_DIRECT flag of the open() system call for a file used in a mirror disk resource.  
Examples include the Oracle parameter `filesystemio_options = setall`.
- ◆ Do not specify a mirror partition device (such as /dev/NMP1) as the monitor target in the READ (O\_DIRECT) disk monitoring mode.
- ◆ For the data partition and the cluster partition of mirror disk resources, use disk devices with the same logical sector size on all servers. If you use devices with different logical sector sizes, they do not operate normally. They can operate even if they have different sizes for the data partition and the cluster partition.

Examples)

Combination	Logical sector size of the partition				Description
	Server 1		Server 2		
	Data partition	Cluster partition	Data partition	Cluster partition	
OK	512B	512B	512B	512B	The logical sector sizes are uniform.
OK	4KB	512B	4KB	512B	The data partitions have a uniform size of 4 KB, and the cluster partitions have a uniform size of 512 bytes.
NG	4KB	512B	512B	512B	The logical sector sizes for the data partitions are not uniform.
NG	4KB	4KB	4KB	512B	The logical sector sizes for the cluster partitions are not uniform.

- ◆ Do not use HDDs and SSDs in combination for the disks used for the data partition and the cluster partition of mirror disk resources. If you used them in combination, optimum performance cannot be obtained. Even if disks with different disk types are used for the data partition and the cluster partition, they can operate.

Examples)

Combination	Logical sector size of the partition				Description
	Server 1		Server 2		
	Data partition	Cluster partition	Data partition	Cluster partition	
OK	HDD	HDD	HDD	HDD	The disk types are uniform.
OK	SSD	HDD	SSD	HDD	The data partitions are of the uniform disk type of SSD, and the cluster partitions are of the uniform type of HDD.
NG	SSD	HDD	HDD	HDD	As the data partitions, both HDD and SSD are used.
NG	SSD	SSD	SSD	HDD	As the cluster partitions, both HDD and SSD are used.

- ◆ The bit64 format of an ext4 filesystem is not supported.  
To format ext4 manually on RHEL7, Asianux Server 7, and Ubuntu, add the option to disable bit64 to the `mkfs` command.  
For details, refer to “If using ext4 with a mirror disk resource or a hybrid disk resource” of Chapter 5 “Notes and Restrictions” in the *Getting Started Guide*.

## mount processing flow

The mount processing needed to activate the mirror disk resource is performed as follows:

1. Is the device already mounted?  
When already mounted → To X
  2. Is `fsck` set to be run before mounting?  
Timing at which to run `fsck` → Run `fsck` for the device.
  3. Mount the device.  
Mounted successfully → To O
  4. Is mounting set to be retried?  
When retry is not set → To X
  5. When `fsck(xfs_repair)` is set to be run if mounting fails:  
When `fsck` has run successfully in 2. → Go to 6.  
When mounting fails due to a timeout in 3. → Go to 6.  
Other than the above → Run `fsck(xfs_repair)` for the device.
  6. Retry mounting of the device.  
Mounted successfully → To O
  7. Has the retry count for mounting been exceeded?  
Within the retry count → Go to 6.  
The retry count has been exceeded → To X
- O The resource is activated (mounted successfully).  
X The resource activation has failed (not mounted).

## umount processing flow

The unmount processing to deactivate the mirror disk resource is performed as follows:

1. Is the device already unmounted?  
When already unmounted → To X
  2. Unmount the device.  
Unmounted successfully → To O
  3. Is unmount set to be retried?  
When retry is not set → To X
  4. Is the device still mounted? (Is the mount point removed from the mount list and is the mirror device in the unused status?)  
No longer mounted → To O
  5. Try KILL for the process using the mount point.
  6. Retry unmount of the device.  
Unmounted successfully → To O
  7. Is the result other than the unmount timeout and is the mount point removed from the mount list?  
The mount point has already been removed.  
→ Wait until the mirror device is no longer used.  
(Wait no more than a length of time equal to the unmount timeout.)
  8. Has the retry count for unmount been exceeded?  
Within the retry count → Go to 4.  
The retry count is exceeded → To X
- O The resource is stopped (unmounted successfully).  
X The resource stop has failed (still mounted, or already unmounted).

## Conditions under which the mirror status becomes abnormal

The following lists the most common situations in which the status of a mirror disk resource changes from normal (GREEN) to abnormal (RED).

- ◆ Due to the disconnection of communication (mirror disconnect), stoppage of the standby server, etc., mirror synchronization between the active and standby servers fails, leading to differences between the servers.  
The standby server does not retain the latest data, so enters the abnormal (RED) state.
- ◆ Settings are made so that mirror data is not synchronized, causing differences between the active and standby servers.  
The standby server does not retain the latest data, so enters the abnormal (RED) state.
- ◆ A mirror disk disconnection (mirroring interruption) operation is performed.  
The standby server enters the abnormal (RED) state.
- ◆ Mirror recovery is interrupted during mirror recovery (during mirror re-synchronization).  
The standby server has not completed copying, so enters the abnormal (RED) state.
- ◆ The active server does not execute cluster shutdown normally due to server down, etc. (The activated mirror disk resource stops without switching to the deactivated state.)  
The mirror disk of the server enters the abnormal (RED) state after the server starts.
- ◆ After a mirror disk is activated by starting only one server, the server is stopped without performing mirror synchronization, and then the other server is started and the mirror disk is activated.  
Because the mirror disks of the two servers are updated individually, those disks enter the abnormal (RED) state.  
If the mirror disks of the two servers are updated individually as described above, it is not possible to automatically judge the mirror disk of which server should act as the copy source, so automatic mirror recovery is not performed. In this case it is necessary to execute forced mirror recovery.
- ◆ Due to the disconnection of communication (mirror disconnect), reboot of the standby server, etc., mirror synchronization between the active and standby servers fails, causing differences between the servers and, later, the active server fails to execute cluster shutdown normally due to a server down, etc.  
In this case, if the server normally fails over to the standby server later, both servers enter the abnormal (RED) state after the servers start.  
In this case, automatic mirror recovery is not performed, either. Rather, it is necessary to execute forced mirror recovery.

For details on how to refer to the status of a mirror, see the following:

- ◆ Chapter 1 Functions of WebManager
  - Mirror disk helper
    - Overview of the mirror disk helper
- ◆ Chapter 3 EXPRESSCLUSTER command reference
  - Displaying the mirror status (`clpmdstat` command)
    - Display example
      - Displaying the status of mirror disk resource

For details on how to perform the mirror recovery or forcible mirror recovery, see the following:

- ◆ Chapter 11 Troubleshooting
  - Troubleshooting
    - Recovering from mirror breaks
    - Automatically recovering from mirroring
    - Checking the mirror break status with a command
    - Recovering mirror with a command
    - Running the forcible mirror recovery with a command
    - Running the forcible mirror recovery with a command only on one server
    - Checking the mirror break status from the WebManager
    - Recovering mirror using the WebManager
    - Running the forcible mirror recovery using the WebManager
    - Running the forcible mirror recovery from the WebManager only on one server

## Displaying and changing the details of mirror disk resource

1. From the tree view displayed on the left pane of the Builder, click the icon of the group to which the mirror disk resource belongs.
2. The group resource list is displayed on the table view in the right pane of the window. Right-click the desired mirror disk resource name, and select **Properties** on the shortcut menu. In the properties dialog box, click the **Details** tab.
3. Display and/or change the detailed settings on the **Details** tab as described below.

### Mirror Disk Resource Property: Details tab

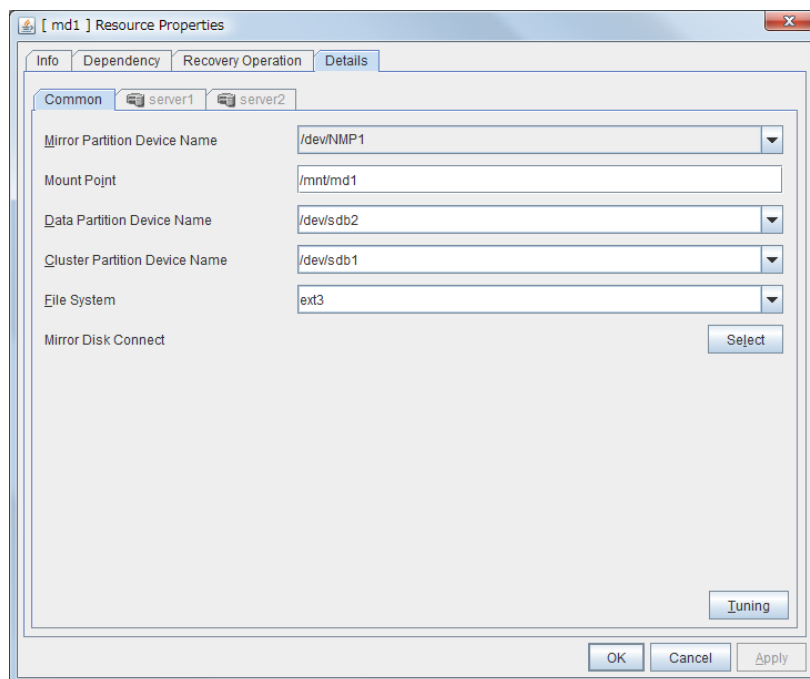

#### Mirror Partition Device Name

Select a mirror partition device name to be associated with the mirror partition.

Device names of mirror disk resource/hybrid disk resource that have already been configured are not displayed on the list.

#### Mount Point (Within 1023 bytes) **Server Individual Setup**

Specify a directory to mount the mirror partition device. The name should begin with “/.”

#### Data Partition Device Name (Within 1023 bytes) **Server Individual Setup**

Specify a data partition device name to be used for a disk resource.

The name should begin with “/.”

#### Cluster Partition Device Name (Within 1023 bytes) **Server Individual Setup**

Specify a cluster partition device name to be paired with the data partition.

The name should begin with “/.”

### File System

You select a file system type to be used on the mirror partition. Choose one from the list box. You may also directly enter the type.

- ◆ ext2
- ◆ ext3
- ◆ ext4
- ◆ xfs
- ◆ jfs
- ◆ reiserfs

### Mirror Disk Connect

Add, delete or modify mirror disk connects. In the **Mirror Disk Connects** list, I/F numbers of the mirror disk connects used for mirror disk resources are displayed.

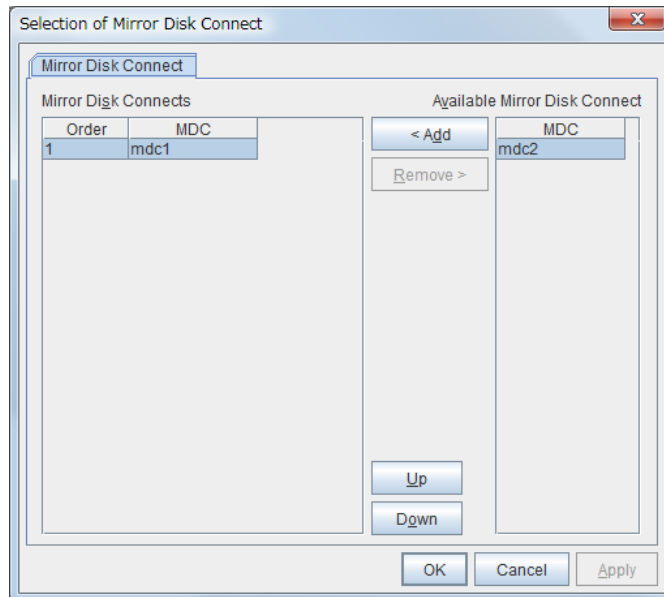

In **Available Mirror Disk Connect**, mirror disk connect I/F numbers that are currently not used are displayed.

- ◆ Set mirror disk connects on the Cluster Properties.
- ◆ Maximum of two mirror disk connects can be used per mirror disk resource. For the behavior when two mirror disk connects are used, see “Mirror disk” on page 706.
- ◆ For details on how to configure mirror disk connects, see the *Installation and Configuration Guide*.



### Add

Use **Add** to add a mirror disk connect. Select the I/F number you want to add from **Available Mirror Disk Connect** and then click **Add**. The selected number is added to the **Mirror Disk Connects** list.

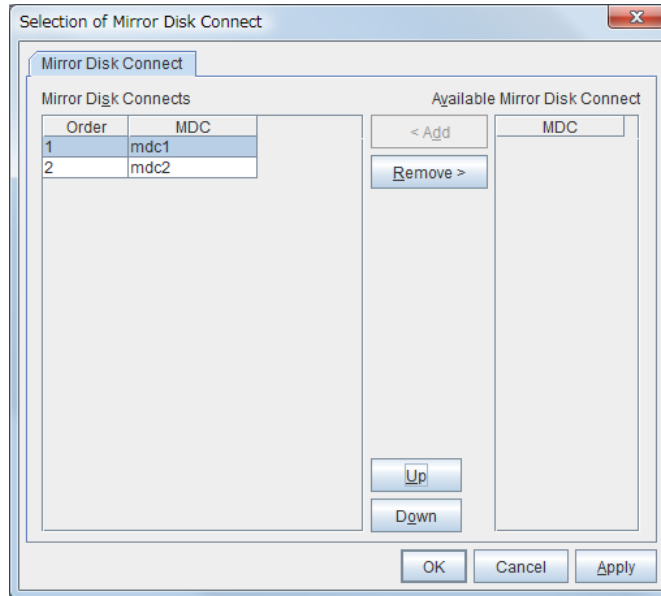

### Remove

Use **Remove** to remove mirror disk connects to be used. Select the I/F number you want to remove from the **Mirror Disk Connect** list and then click **Remove**. The selected number is added to **Available Mirror Disk Connect**.

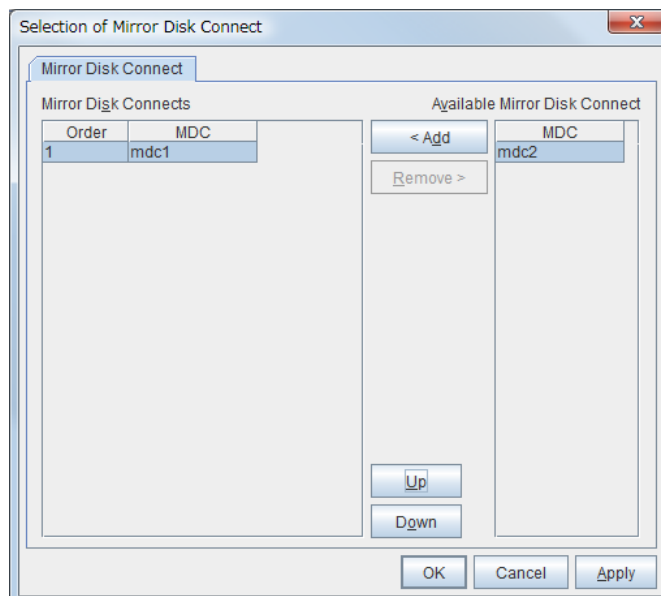

### Up & Down

Use **Up** and **Down** to change the priority of mirror disk connects to be used. Select the I/F number you want to change from the **Mirror Disk Connect** list and then click **Up** or **Down**.

### Tuning

Opens the **Mirror Disk Resource Tuning Properties** dialog box. You make detailed settings for the mirror disk resource there.

### Mirror disk resource tuning properties

#### Mount tab

The advanced settings of mount are displayed.

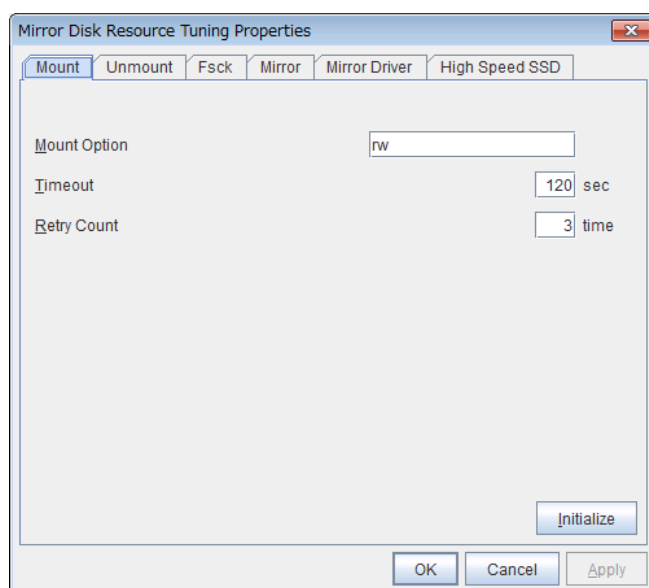

#### Mount Option (Within 1023 bytes)

Enter options to give the mount command when mounting the file system on the mirror partition device. Use a comma “,” to separate multiple options.

#### Mount option example

Setting item	Setting value
Mirror partition device name	/dev/NMP5
Mirror mount point	/mnt/sdb5
File system	ext3
Mount option	rw,data=journal

The mount command to be run with the above settings is:

```
mount -t ext3 -o rw,data=journal /dev/NMP5 /mnt/sdb5
```

**Timeout** 1 to 999

Enter how many seconds you want to wait for the mount command completion before its timeout when you mount the file system on the mirror partition device. Be careful about the value you specify. That is because it may take some time for the command to complete if the capacity of the file system is large.

**Retry Count** 0 to 999

Enter how many times you want to retry to mount the file system on the mirror partition device when one fails. If you set this to zero (0), mount will not be retried.

**Initialize**

Clicking **Initialize** resets the values of all items to the default values.

**Unmount tab**

The advanced settings for unmounting are displayed.

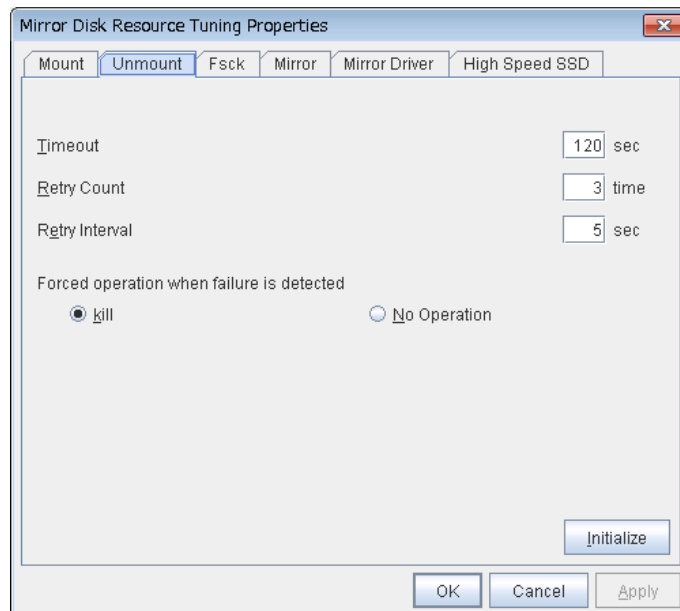
**Timeout** 1 to 999

Enter how many seconds you want to wait for the unmount command completion before its timeout when you unmount the file system on the mirror partition device.

**Retry Count** 0 to 999

Enter how many times you want to retry to unmount the file system on the mirror partition device when one fails. If you set this to zero (0), unmount will not be retried.

**Retry Interval** 0 to 999

Enter the interval in which you want to retry unmounting the file system from the mirror partition device when unmounting fails.

### Forced Operation When Detecting Failure

Select an action to be taken at an unmount retry if unmount fails.

- ◆ **kill:**  
Select this option to try to forcibly terminate the processes that are accessing the mount point. Not all processes can be terminated.
- ◆ **none:**  
Select this option not to try killing the processes that are accessing the mount point.

### Initialize

Clicking **Initialize** resets the values of all items to the default values.

### Fsck tab

The advanced settings of fsck are displayed.

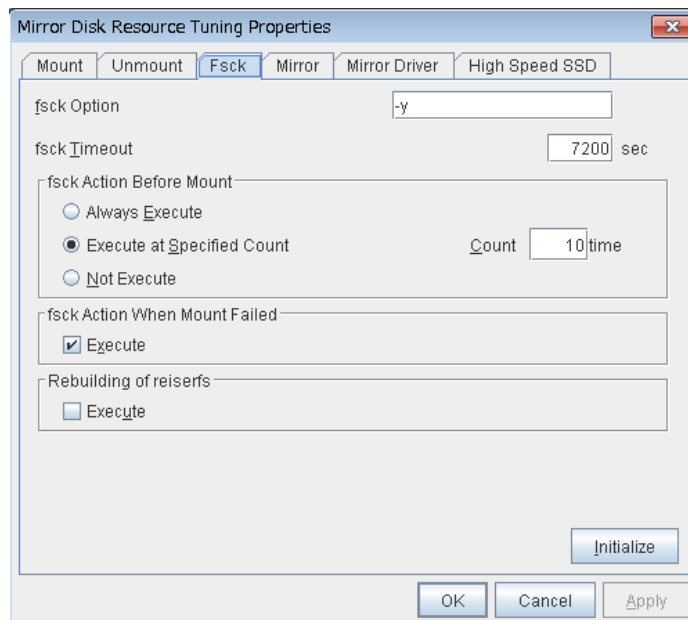

#### **fsck Option** (Within 1023 bytes)

Enter options to give the fsck command when checking the file system on the mirror partition device. Use a space to separate multiple options. Specify options so that the fsck command does not run interactively. Otherwise, activation of resources after the time specified to **fsck Timeout** elapses becomes an error.

#### **fsck Timeout** 1 to 9999

Enter how many seconds you want to wait for the fsck command completion before its timeout when you check the file system on the mirror partition device. Be careful about the value you specify. This is because it may take some time for the command to complete if the capacity of the file system is large.

**fsck action before mount**

Select an fsck action before mounting file system on a disk device from the following choices:

- ◆ Always Execute:  
fsck is executed before mounting the file system.
- ◆ Execute at Specified Count:  
fsck is executed when resource is activated successfully within the count specified by Count.  
= Count (0~999)
- ◆ Not Execute:  
fsck is not executed before mounting the file system.

---

**Note:**

The specified count for fsck is not related to the check interval managed by a file system.

---

**fsck Action When Mount Failed**

Set an fsck action to take when detecting a mount failure on a disk device.

This setting is enabled when the setting of Mount **Retry Count** is other than zero.

- ◆ When the check box is selected:  
Mount is retried after running fsck.
- ◆ When the check box is not selected:  
Mount is retried without running fsck.

---

**Note:**

It is not recommended to set “Not Execute” fsck action before performing mount. With this setting, disk resource does not execute fsck and disk resource cannot be failed over when there is an error that can be recovered by fsck in the switchable partition.

---

**Reconstruction of reiserfs**

Specify the action when reiserfsck fails with a recoverable error.

- ◆ When the checkbox is selected  
reiserfsck --fix-fixable is executed.
- ◆ When the checkbox is not selected  
Recovery is not performed even if reiserfsck fails with a recoverable error.

**Initialize**

Clicking **Initialize** resets the values of all items to the default values.

**xfs\_repair tab**

The detailed settings related to [xfs\_repair] are displayed. The tab appears only if [xfs] is set for the file system.

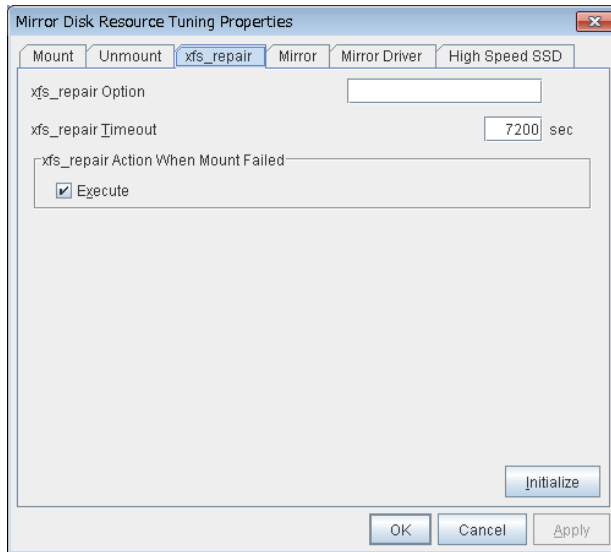

**xfs\_repair Option (Within 1023 bytes)**

Enter the option to give to the [xfs\_repair] command when checking the file system on the disk device. To enter multiple options, delimit each with a space.

**xfs\_repair Timeout (1-9999)**

Enter how many seconds you want to wait for the [xfs\_repair] command completion before its timeout when you check the file system on the disk device. If the file system has a large size of disk space, it may take some time for the command to complete. Make sure that the value to set is not too small.

**xfs\_repair Action When Mount Failed**

Set the [xfs\_repair] action when mounting the file system on the disk device fails. This setting is enabled when the setting of **Mount Retry Count** is other than zero.

- ◆ When the check box is selected:
  - Mount is retried after running [xfs\_repair].
- ◆ When the check box is not selected:
  - Mount is retried without running [xfs\_repair].

**Initialize**

Clicking **Initialize** resets the values of all items to the default values.

### Mirror tab

The advanced settings of mirror disks are displayed.

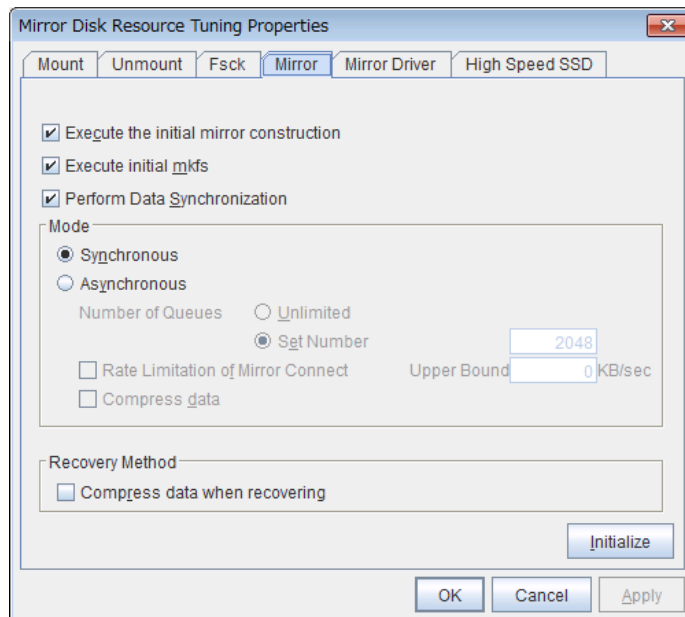

### Execute the initial mirror construction

Specify if an initial mirror configuration is constructed when constructing a cluster.

- ◆ When the check box is selected:
  - An initial mirror configuration will be constructed.
  - The time that takes to construct the initial mirror is different from ext2/ext3/ext4 and other file systems.
- ◆ When the check box is not selected:
  - An initial mirror configuration will not be constructed.

### Execute initial mkfs

Specify if an initial mkfs is constructed when constructing a cluster. This option can be set only if the initial mirror is being constructed.

In the case of hybrid disk resources, the clphdinit command behavior is executed instead of initial mkfs behavior upon cluster construction

- ◆ When the check box is selected:
  - An initial mkfs will be run.
- ◆ When the check box is not selected:
  - An initial mkfs will not be run.

### Execute data synchronization

Specify if the mirror data synchronization is executed when mirror disk resource is activated.

- ◆ When the check box is selected:  
Mirror data synchronization is executed. The write data is passed from the active server to the standby server. The `clpmdctr` command and `clphdctrl` command can be used not to synchronize mirror data.
- ◆ When the check box is not selected:  
Mirror data synchronization will not be executed. The write data will not be passed from the active server to the standby server and will be accumulated as the finite difference. You can use the `clpmdctrl` command and `clphdctrl` command to switch to the status where mirror data is synchronized.

### mode

Specify synchronous mode of mirror data.

- ◆ [Synchronous]  
Select when LAN is mainly used for mirror connect.
- ◆ [Asynchronous]  
Select when WAN is mainly used for mirror connect. Specify Number of Queues when Asynchronous is chosen. Specify it for each mirror disk resource.
  - Unlimited:  
Queues will be allocated as long as possible to allocate memory. When it failed to allocate memory, mirror breaks.
  - Set Number(1~999999):  
Specify maximum number of queues to be allocated. When synchronous data exceeds it, mirror breaks.

When **Asynchronous** is selected, the **Rate limitation of Mirror Connect** check box can be selected.

- When the check box is selected (1 to 999999999)  
The upper rate limitation of mirror connect is set.
- When the check box is cleared  
The upper rate limitation of mirror connect is not set.

When **Asynchronous** is selected, the **Compress data** check box can be selected.

- When the check box is selected  
Mirror synchronous communication data is compressed.
- When the check box is cleared  
Mirror synchronous communication data is not compressed.

### Compress Recovery Data

Specify whether to compress mirror recovery communication data.

### Initialize

Clicking **Initialize** resets the values of all items to the default values.



### Mirror driver tab

Advanced settings for a mirror driver is displayed.

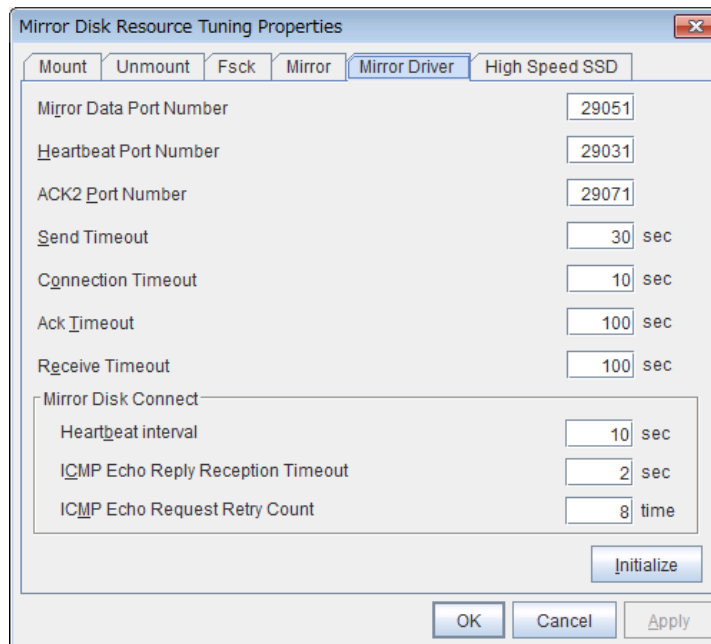

#### Mirror Data Port Number (1 to 65535 <sup>6</sup>)

Set the TCP port number used for sending and receiving disk data between servers. The default value 29051 is set to the mirror disk resource or the hybrid disk resource created first. From a second mirror disk resource or the hybrid disk resource, the value increased by one from default (29052,29053,...) is set accordingly.

#### Heartbeat Port Number (1 to 65535 <sup>6</sup>)

Set the port number that a mirror driver uses to communicate control data between servers. The default value 29031 is set to the mirror disk resource or the hybrid disk resource created first. From a second mirror disk resource or the hybrid disk resource, the value increased by one from default (29032, 29033,...) is set accordingly.

#### ACK2 Port Number (1 to 65535 <sup>6</sup>)

Set the port number that a mirror driver uses to communicate control data between servers. The default value 29071 is set to the mirror disk resource or the hybrid disk resource created first. From a second mirror disk resource or the hybrid disk resource, the value increased by one from default (29072, 29073,...) is set accordingly.

#### Send Timeout (10 to 99)

Set the delivery time-out for write data.

#### Connection Timeout (5 to 99)

<sup>6</sup> It is not recommended to use well-known ports, especially reserved ports from 1 to 1023.  
Section II Resource details

Set the time-out for connection.

**Ack Timeout** (1 to 600)

Set the time-out which waits for Ack response when mirror recovers and data is synchronized.

**Receive Timeout** (1 to 600)

Set the receive time-out for write confirmation.

**Heartbeat Interval** (1 to 600)

Set the heartbeat interval between mirror disk connects by the mirror driver.

**ICMP Echo Reply Receive Timeout** (1 to 100)

Set the heartbeat timeout between mirror disk connects by the mirror driver. If no-response is returned for the ICMP Echo Request retry count during the time set here, a mirror disk connect disconnection is assumed.

**ICMP Echo Request Retry Count** (1 to 50)

Set the heartbeat retry count between mirror disk connects by the mirror driver. This value is related to the mirror connect disconnection judgment sensitivity as well as the ICMP Echo Reply receive timeout.

**Initialize**

Clicking **Initialize** resets the following values to the default values.

- Send Timeout
- Connection Timeout
- Ack Timeout
- Receive Timeout
- Heartbeat Interval
- ICMP Echo Reply Receive Timeout
- ICMP Echo Request Retry Count

---

**Note:**

For **Mirror Data Port Number**, **Heartbeat Port Number** and **ACK2 Port Number**, different port numbers should be configured for each resource. Also, those should not be the same as other port numbers used on a cluster. Thus, the initial values are not set even when you click **Initialize**.

---

### High-speed SSD tab

The detailed settings for the high-speed SSD specifications in mirror disk resources are displayed.

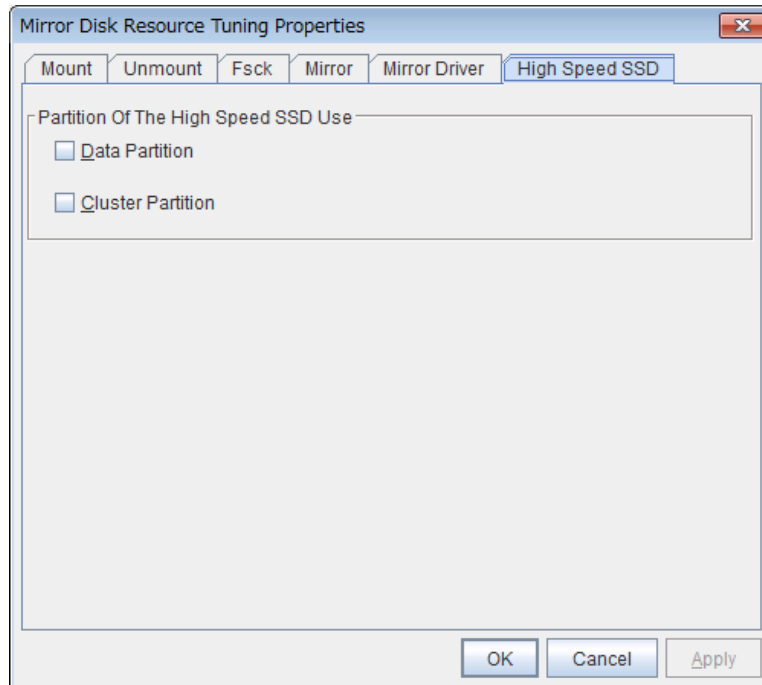

### Data Partition

Select the check box when you use a high-speed SSD for the data partition of mirror disk resources. Make sure that the disk devices used for the data partitions on all nodes are either HDDs or SSDs. If they are used in combination, optimum performance cannot be exerted.

### Cluster Partition

Select the check box when you use a high-speed SSD for the cluster partition of mirror disk resources. Make sure that the disk devices used for the cluster partitions on all nodes are either HDDs or SSDs. If they are used in combination, optimum performance cannot be exerted.

## Displaying the mirror disk resource property with the WebManager ~For Replicator ~

1. Start the WebManager.
2. When you click an object for a mirror disk resource  in the tree view, the following information is displayed in the list view.

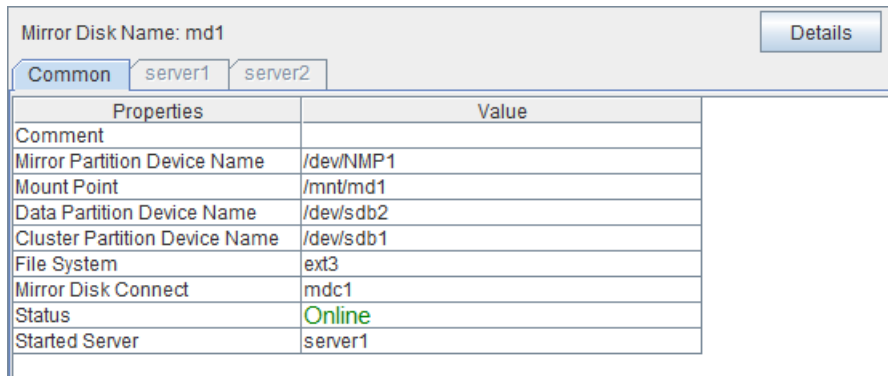

Mirror Disk Name: md1		Details
Common		server1
server2		
Properties	Value	
Comment		
Mirror Partition Device Name	/dev/NMP1	
Mount Point	/mnt/md1	
Data Partition Device Name	/dev/sdb2	
Cluster Partition Device Name	/dev/sdb1	
File System	ext3	
Mirror Disk Connect	mdc1	
Status	Online	
Started Server	server1	

Comment:	Comment
Mirror Partition Device Name:	Name of the mirror partition device linked to the mirror partition
Mount Point:	Directory where the mirror partition device is mounted
Data Partition Device Name:	Name of the data partition device used as a mirror disk resource
Cluster Partition Device Name:	Name of the cluster partition device to be paired with the data partition
File System:	Type of the file system used on the mirror partition
Mirror Disk Connect:	IP address for the mirror disk resource
Status:	Status of the mirror disk resource
Started Server:	Server name

Clicking **Details** also displays the following information in the popup dialog box:

Properties	Value
Name	md1
Type	md
Failover Threshold	1
Retry Count at Activation Failure	0
Final Action at Activation Failure	No operation (not activate next resource)
Execute Script before Final Action	Off
Retry Count at Deactivation Failure	0
Final Action at Deactivation Failure	Stop the cluster service and shutdown OS
Execute Script before Final Action	Off
Depended Resources	
Mount Option	rw
Mount Timeout (sec)	120
Mount Retry Count	3
Unmount Timeout (sec)	120
Unmount Retry Count	3
Unmount Retry Interval	5
Action at Unmount Failure	kill
Fsck Option	-y
Fsck Timeout (sec)	7200
Fsck Action Before Mount	Execute at Specified Count
Fsck Interval	10
Fsck Action When Mount Failed	Execute
Re-restoration of Reiserfs	None
Initial Mirror Recovery	Yes
Initial Mkfs	Yes
Synchronization Data	Yes
Synchronization Mode	Synchronous
Number of Queues	2048
Mode of Communication Band	No
Upper Bound of Communication Band(KB/sec)	Unlimited
Compress Data	No
Mirror Data Port Number	29051
Mirror Heartbeat Port Number	29031
Mirror ACK2 Port Number	29071
Send Timeout (sec)	30
Connection Timeout (sec)	10
ACK Timeout (sec)	100
Receive Timeout (sec)	100
Mirror Heartbeat Interval (sec)	10
ICMP Echo Reply Receive Timeout (sec)	2
ICMP Echo Request Retry Count	8
Disk Type of Data Partition	HDD
Disk Type of Cluster Partition	HDD
Xfs_repair Action	Execute
Xfs_repair Option	
Xfs_repair Timeout (sec)	7200

- Name: Mirror disk resource name
- Type: Resource type
- Failover Threshold: Maximum number of times that failover is performed at an activation error
- Retry Count at Activation Failure: Maximum number of times that activation is retried at an activation error
- Final Action at Activation Failure: Final action at an activation error
- Execute Script before Final Action: Whether or not script is executed upon activation failure
- Retry Count at Deactivation Failure: Maximum number of times that inactivation is retried at an inactivation error
- Final Action at Activation Failure: Final action at an inactivation error
- Execute Script before Final Action: Whether or not script is executed upon deactivation failure
- Dependent Resources: Dependent resource
- Mount Option: Options to pass to the mount command when mounting a file system
- Mount Timeout (sec): Timeout for waiting for the completion of the mount command (in seconds)
- Mount Retry Count: Mount retry count when the mount command fails
- Unmount Timeout (sec): Timeout for waiting for the completion of the unmount command to (in seconds)

Unmount Retry Count:	Unmount retry count when the umount command fails
Unmount Retry Interval:	Unmount retry interval (in seconds)
Action at Unmount Failure:	Action to be taken at an unmount error <ul style="list-style-type: none"> <li>kill                      Force termination</li> <li>No Operation          No action</li> </ul>
fsck Option:	Options to be passed to the fsck command
fsck Timeout:	Timeout for waiting for the completion of the fsck command (in seconds)
fsck Action Before Mount:	fsck timing at mount <ul style="list-style-type: none"> <li>• Does not execute fsck</li> <li>• Always execute fsck</li> <li>• Executes fsck when reached to fsck interval</li> </ul>
fsck Interval:	fsck interval
Fsck Action When Mount Failed:	Action when mount failed <ul style="list-style-type: none"> <li>• No action</li> <li>• Executes fsck</li> </ul>
Reconstruction of reiserfs	Action when reiserfsck failed <ul style="list-style-type: none"> <li>• No operation</li> <li>• Execute recovery by reiserfsck</li> </ul>
Initial Mirror Recovery:	Mirror recovery at cluster configuration
Initial mkfs:	Initial mkfs execution at cluster configuration
Synchronization Data:	Synchronization of mirror data
Synchronization Mode:	Synchronization mode of mirror data
Number of Queues:	Number of queues used for asynchronous mirroring
Mode of Communication Band:	Mode of communication band
Upper Bounds of Communication Band (KB/second):	Upper rate limitation of mirror connect (KB/second)
Compress Data:	Whether or not compressing mirror data at asynchronous mirroring and at mirror recovery
Mirror Data Port Number:	Data port number of a mirror disk
Mirror Heartbeat Port Number:	Heartbeat port number of a mirror disk
Mirror ACK2 Port Number:	Port number used for ACK2 of a mirror disk
Send Timeout (sec):	Send timeout (in seconds)
Connection Timeout (sec):	Connection timeout (in seconds)
ACK Timeout (sec):	Timeout waiting for ACK response(in seconds)
Receive Timeout (sec):	Receive timeout waiting for writes confirmation (in seconds)
Mirror heartbeat interval (sec):	Mirror disk connect heartbeat interval (in seconds)
ICMP Echo Reply Receive Timeout (sec):	ICMP Echo Reply receive timeout for the mirror disk connect (in seconds)
ICMP Echo Request Retry Count	The maximum send count for ICMP Echo Request of the mirror disk connect
Disk Type of Data Partition:	Disk type of data partition
Disk Type of Cluster Partition:	Disk type of cluster partition
Xfs_repair Action When Mount Failed	Action to be taken at a mount error <ul style="list-style-type: none"> <li>• No action</li> <li>• Perform xfs_repair</li> </ul>
Xfs_repair Option:	Options passed to the xfs_repair command
Xfs_repair Timeout (sec):	Timeout for the xfs_repair command execution (in seconds)

# Understanding hybrid disk resources

## Dependencies of hybrid disk resource

By default, this function depends on the following group resource types.

Group resource type
Floating IP resource
Virtual IP resource
AWS elastic ip resource
AWS virtual ip resource
Azure probe port resource

## What is hybrid disk?

A hybrid disk is a resource which performs data mirroring between two server groups. A server group consists of 1 server or 2 servers. When a server group consists of 2 servers, a shared disk is used. When a server group consists of 1 server, a disk which is not shared type (e.g. a built-in disk, an external disk chassis which is not shared between servers) is used.

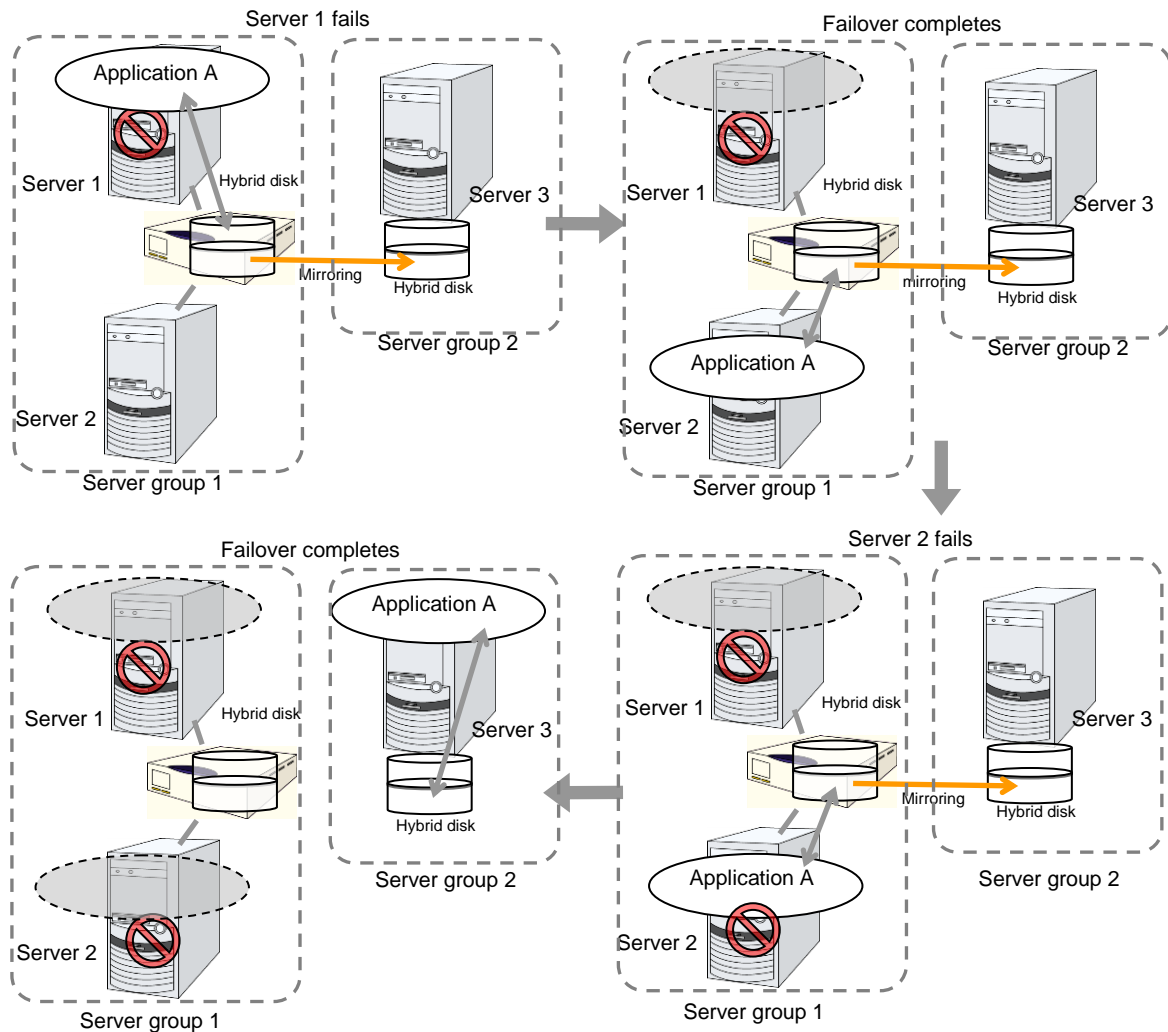

### Data partition

Partitions where data to be mirrored (such as application data) is stored are referred to as data partitions.

Allocate data partitions as follows:

- ◆ Data partition size
  - The size of data partition should be 1GB or larger but smaller than 1TB.
  - (Less than 1TB size is recommended from the viewpoint of the construction time and the restoration time of data.)



- ◆ Partition ID  
83(Linux)
- ◆ Please make the file system on data partitions if you need. Automatic initial mkfs is not executed.
- ◆ EXPRESSCLUSTER is responsible for the access control (mount/umount) of file system. Do not configure the settings that allow the OS to mount or unmount a data partition.

### Cluster partition

Dedicated partitions used in EXPRESSCLUSTER for controlling hybrid disk are referred to as cluster partition.

Allocate cluster partitions as follows:

- ◆ Cluster partition size  
10 MB or more. Depending on the geometry, the size may be larger than 10 MB but that is not a problem.
- ◆ Partition ID  
83(Linux)
- ◆ A cluster partition and data partition for data mirroring should be allocated in a pair.
- ◆ You do not need to make the file system on cluster partitions.

### Mirror Partition Device (/dev/NMPx)

One hybrid disk resource provides the file system of the OS with one mirror partition. If a hybrid disk resource is registered with the failover group, it can be accessed only from one server (it is generally the primary server of the resource group).

Typically, the mirror partition device (dev/NMPx) remains transparent to users (AP) because I/O is performed via a file system. When the information is created by the Builder, device names should be assigned without overlapping with each other.

- ◆ EXPRESSCLUSTER is responsible for the access control (mount/umount) of file system. Do not configure the settings that allow the OS to mount or unmount a data partition.  
Mirror partition's (hybrid disk resource's) accessibility to applications is the same as switching partition (disk resources) that uses shared disks.
- ◆ Mirror partition switching is performed on a failover group basis according to the failover policy.
- ◆ /dev/NMPx(x is a number between 1 and 8) is used for the special device name of mirror partition. Do not use /dev/NMPx in other device drivers.
- ◆ The major number 218 is used for mirror partition. Do not use the major number 218 in other device drivers.

Example 1) When two servers use the shared disk and the third server uses the built-in disk

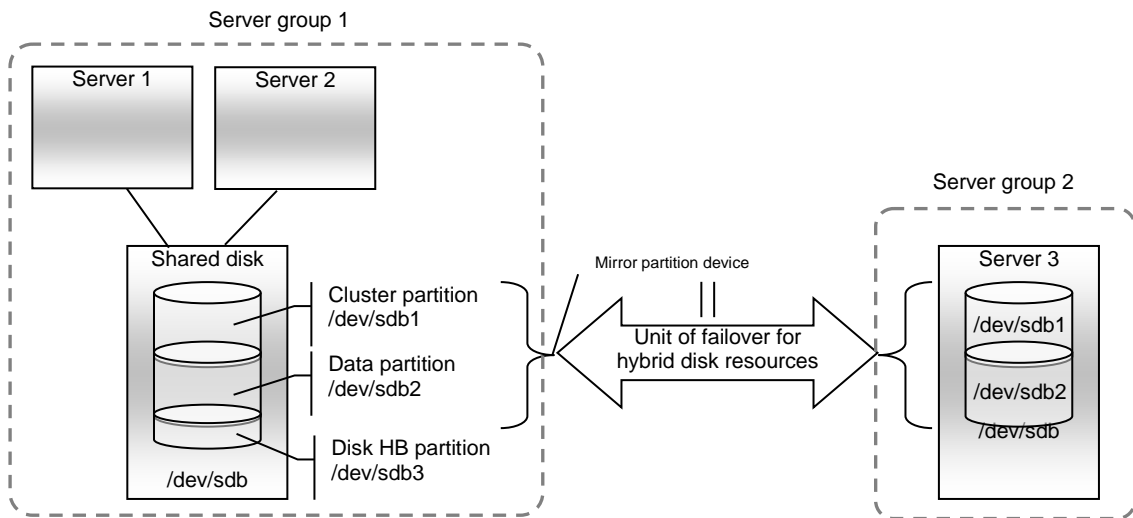

- When a non-shared disk is used (i.e. when there is one server in the server group), it is possible to secure a partition for the hybrid disk resource (cluster partition and data partition) on the same disk where the OS (root partition and swap partition) is located.
  - When maintainability at a failure is important:
    - It is recommended to allocate a disk for mirror which is not used by the OS (such as root partition, swap partition).
  - If LUN cannot be added due to H/W RAID specifications:
    - If you are using hardware/RAID preinstall model where the LUN configuration cannot be changed, you can allocate a mirror partition (cluster partition, data partition) in the disk where the OS (root partition, swap partition) is located.

**Mirror disk connect**

See “Mirror disk connect” for the mirror disk resource on page 707

## Mirror parameter settings

The following parameters are the same as those of mirror disk resources. See “mirror disk resources”.

- ◆ Mirror data port number
- ◆ Heartbeat port number
- ◆ ACK2 port number
- ◆ The maximum number of request queues
- ◆ Connection timeout
- ◆ Send timeout
- ◆ Receiving timeout
- ◆ Ack timeout
- ◆ Bitmap update interval (cluster properties)
- ◆ Mirror agent send timeout (cluster properties)
- ◆ Mirror agent receiving timeout (cluster properties)
- ◆ Recovery data size (cluster properties)
- ◆ Initial mirror construction
- ◆ Number of Queues
- ◆ Mode of Communication Band
- ◆ Heartbeat Interval
- ◆ ICMP Echo Reply Receive Timeout
- ◆ ICMP Echo Request Retry Count

The following parameter is different from mirror disk resource.

- ◆ Initial mkfs  
Automatic initial mkfs is not executed. Please execute mkfs manually.

## Notes on hybrid disk resources

- ◆ If device names for the cluster partitions or the data partitions differ between servers, set up each server separately. In addition, if the device names differ between servers belonging to the same server group, set by-id to the device name.
- ◆ If **Mount/Unmount Exclusion** is selected on the **Exclusion** tab in **Cluster Properties**, activation/deactivation of hybrid disk resource may take time because `mount/umount` is performed exclusively to disk resource, VxVM volume resource, NAS resource, mirror resource and hybrid disk resource in the same server.
- ◆ When specifying path including symbolic link for mount point, Force Operation cannot be done even if it is chosen as operation in failure detection. Similarly, if a path containing “//” is specified, forced termination will also fail.
- ◆ Disks using stripe set, volume set, mirroring, stripe set with parity by Linux `md` cannot be specified for the cluster partition and data partition.
- ◆ Hybrid disk resources (mirror partition devices) cannot be the targets of stripe set, volume set, mirroring, stripe set with parity by Linux `md` or LVM.
- ◆ When the geometries of the disks used as hybrid disks differ between the servers:

The size of a partition allocated by the `fdisk` command is aligned by the number of blocks (units) per cylinder. Allocate data partitions to achieve the following data partition size and direction of the initial mirror construction.

### Source server ≤ Destination server

“Source server” refers to the server with the higher failover policy in the failover group to which a hybrid disk resource belongs.

“Destination server” refers to the server with the lower failover policy in the failover group to which a hybrid disk resource belongs.

If the data partition sizes differ significantly between the copy source and the copy destination, initial mirror construction may fail. Be careful, therefore, to secure data partitions of similar sizes.

Make sure that the data partition sizes do not cross over 32GiB, 64GiB, 96GiB, and so on (multiples of 32GiB) on the source server and the destination server. For sizes that cross over multiples of 32GiB, initial mirror construction may fail.

Examples)

Combination	Data partition size		Description
	On server 1	On server 2	
OK	30GiB	31GiB	OK because both are in the range of 0 to 32GiB.
OK	50GiB	60GiB	OK because both are in the range of 32GiB to 64GiB.
NG	30GiB	39GiB	Error because they are crossing over 32GiB.
NG	60GiB	70GiB	Error because they are crossing over 64GiB.

- ◆ Do not use the `O_DIRECT` flag of the `open()` system call for a file used in a hybrid disk resource. Examples include the Oracle parameter `filesystemio_options = setall`.

- ◆ Do not specify a mirror partition device (such as /dev/NMP1) as the monitor target in the READ (O\_DIRECT) disk monitoring mode.
- ◆ For a cluster configuration that uses a hybrid disk, do not set the final action of a monitor resource, etc., to **Stop the cluster service**.
- ◆ For the data partition and the cluster partition of hybrid disk resources, use disk devices with the same logical sector size on all servers. If you use devices with different logical sector sizes, they do not operate normally. They can operate even if they have different sizes for the data partition and the cluster partition.

Examples)

Combination	Logical sector size of the partition				Description
	Server 1		Server 2		
	Data partition	Cluster partition	Data partition	Cluster partition	
OK	512B	512B	512B	512B	The logical sector sizes are uniform.
OK	4KB	512B	4KB	512B	The data partitions have a uniform size of 4 KB, and the cluster partitions have a uniform size of 512 bytes.
NG	4KB	512B	512B	512B	The logical sector sizes for the data partitions are not uniform.
NG	4KB	4KB	4KB	512B	The logical sector sizes for the cluster partitions are not uniform.

- ◆ Do not use HDDs and SSDs in combination for the disks used for the data partition and the cluster partition of hybrid disk resources. If you used them in combination, optimum performance cannot be obtained. Even if disks with different disk types are used for the data partition and the cluster partition, they can operate.

Examples)

Combination	Logical sector size of the partition				Description
	Server 1		Server 2		
	Data partition	Cluster partition	Data partition	Cluster partition	
OK	HDD	HDD	HDD	HDD	The disk types are uniform.
OK	SSD	HDD	SSD	HDD	The data partitions are of the uniform disk type of SSD, and the cluster partitions are of the uniform type of HDD.
NG	SSD	HDD	HDD	HDD	As the data partitions, both HDD and SSD are used.
NG	SSD	SSD	SSD	HDD	As the cluster partitions, both HDD and SSD are used.

- ◆ The bit64 format of an ext4 filesystem is not supported. To format ext4 manually on RHEL7, Asianux Server 7, and Ubuntu, add the option to disable bit64 to the `mkfs` command.

For details, refer to “If using ext4 with a mirror disk resource or a hybrid disk resource” of Chapter 5 “Notes and Restrictions” in the *Getting Started Guide*..

◆ Behavior of mirror recovery after the active server goes down abnormally

When the active server goes down abnormally, depending on the timing of the server failure, full mirror recovery or differential mirror recovery is performed.

- When a resource is activated by a server connected via a shared disk (a server in the same server group)

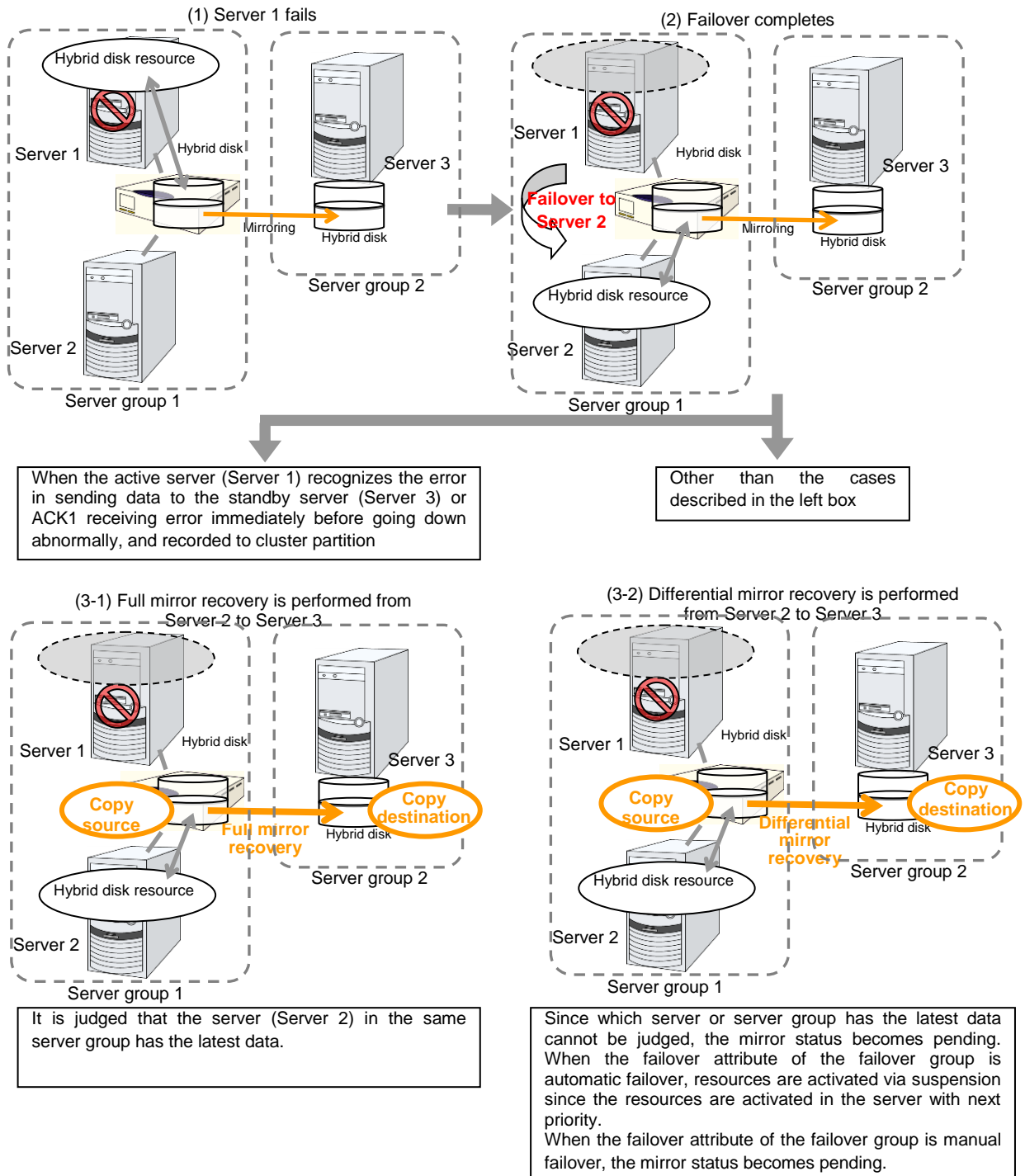

- When a resource is activated by a server in the remote server group

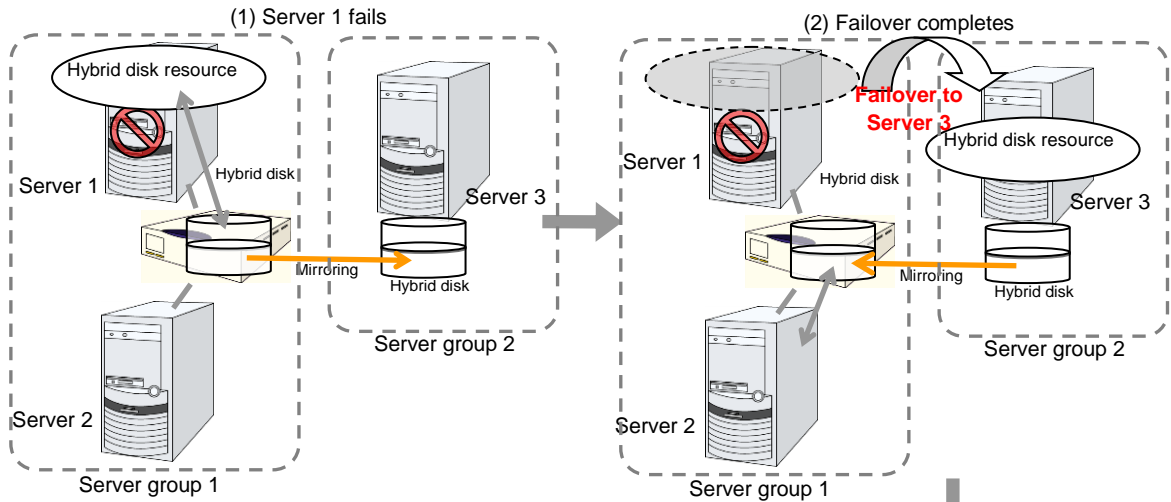

When the active server (Server 1) recognizes the error in sending data to the standby server (Server 3) or ACK1 receiving error immediately before going down abnormally, and recorded to cluster partition

Other than the cases described in the left box

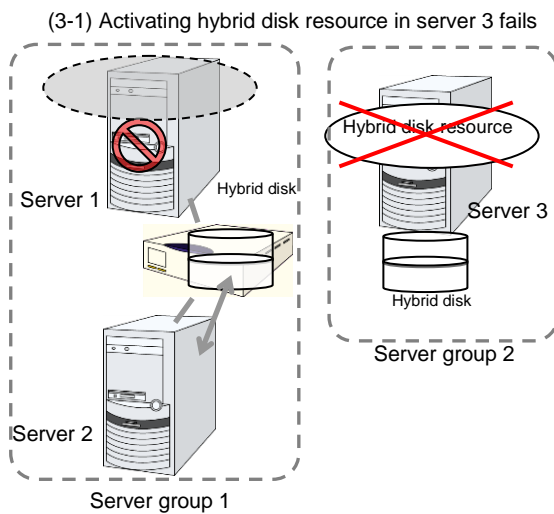

It is judged that server group 1 has the latest data , and activating the group including hybrid disk resources in Server 3 fails.

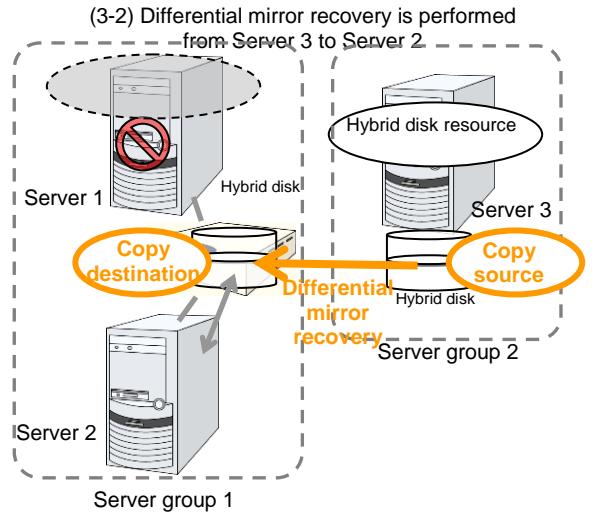

Since which server or server group has the latest data cannot be judged, the mirror status becomes pending. When the failover attribute of the failover group is automatic failover, resources are activated via suspension since the resources are activated in the server with next priority. When the failover attribute of the failover group is manual failover, the mirror status becomes pending.

## mount processing flow

The mount processing needed to activate the hybrid disk resource is performed as follows:

1. Is the device already mounted?  
When already mounted → To X
  2. Is fsck set to be run before mounting?  
Timing at which to run fsck → Run fsck for the device.
  3. Mount the device.  
Mounted successfully → To O
  4. Is mounting set to be retried?  
When retry is not set → To X
  5. When fsck(xfs\_repair) is set to be run if mounting fails:  
When fsck is executed in 2. and mount is successful → Go to 6.  
When mount fails in 3. due to a timeout → Go to 6.  
Other than the above → Execute fsck(xfs\_repair) for the device.
  6. Retry mounting of the device.  
Mounted successfully → To O
  7. Has the retry count for mounting been exceeded?  
Within the retry count → Go to 6.  
The retry count has been exceeded → To X
- O The resource is activated (mounted successfully).  
X The resource activation has failed (not mounted).



## umount processing flow

The umount processing to deactivate the hybrid disk resource is performed as follows:

1. Is the device already unmounted?  
When already unmounted → To X
  2. Unmount the device.  
Unmounted successfully → To O
  3. Is unmount set to be retried?  
When retry is not set → To X
  4. Is the device still mounted? (Is the mount point removed from the mount list and is the mirror device in the unused status?)  
No longer mounted → To O
  5. Try KILL for the process using the mount point.
  6. Retry unmount of the device.  
Unmounted successfully → To O
  7. Is the result other than the unmount timeout and is the mount point removed from the mount list?  
The mount point has already been removed.  
→ Wait until the mirror device is no longer used.  
(Wait no more than a length of time equal to the unmount timeout.)
  8. Has the retry count for unmount been exceeded?  
Within the retry count → Go to 4.  
The retry count is exceeded → To X
- O The resource is stopped (unmounted successfully).
- X The resource stop has failed (still mounted, or already unmounted).

## Displaying and changing the details of hybrid disk resource

1. From the tree view displayed on the left pane of the Builder, click the icon of the group to which the hybrid disk resource belongs.
2. The group resource list is displayed on the table view in the right pane of the window. Right-click the desired hybrid disk resource name, and select **Properties** on the shortcut menu. In the properties dialog box, click the **Details** tab.
3. Display and/or change the detailed settings on the **Details** tab.

The followings are the same as those of mirror disk resources. Refer to “mirror disk resource”.

- ◆ Hybrid disk detail tab (See mirror disk detail tab)
- ◆ Mirror disk connect selection
- ◆ Hybrid disk adjustment properties (See mirror disk adjustment properties)
  - Mount tab
  - Unmount tab
  - Fsck tab
  - xfs\_repair tab
  - Mirror tab (parameter other than the one for executing the initial mkfs)
  - Mirror drive tab
  - High-speed SSD tab

The following tab is different from that of mirror disk resource:

- ◆ Mirror tab of hybrid disk adjustment properties [execute initial mkfs]

### Execute initial mkfs

The hybrid disk resource in this version, automatic initial mkfs is not executed.

## Displaying the hybrid disk resource property with the WebManager ~For Replicator DR~

1. Start the WebManager.
2. When you click an object for a hybrid disk resource  in the tree view, the following information is displayed in the list view.

Hybrid Disk Name: hd1		Details
Common		server1
server2		server3
Properties	Value	
Comment		
Mirror Partition Device Name	/dev/NMP1	
Mount Point	Refer to server's tab	
Data Partition Device Name	Refer to server's tab	
Cluster Partition Device Name	Refer to server's tab	
File System	ext3	
Mirror Disk Connect	mdc1	
Status	Online	
Started Server	server1	

Comment:	Comment
Mirror Partition Device Name:	Name of the mirror partition device linked to the mirror partition
Mount Point:	Directory where the mirror partition device is mounted
Data Partition Device Name:	Name of the data partition device used as a hybrid disk resource
Cluster Partition Device Name:	Name of the cluster partition device to be paired with the data partition
File System:	Type of the file system used on the mirror partition
Mirror Disk Connect:	IP address for the hybrid disk resource
Status:	Status of the hybrid disk resource
Started Server :	Server name

If you click **Details**, the following information is displayed.

Properties	Value
Name	hd1
Type	hd
Failover Threshold	1
Retry Count at Activation Failure	0
Final Action at Activation Failure	No operation (not activate next resource)
Execute Script before Final Action	Off
Retry Count at Deactivation Failure	0
Final Action at Deactivation Failure	Stop the cluster service and shutdown OS
Execute Script before Final Action	Off
Depended Resources	
Mount Option	rw
Mount Timeout (sec)	120
Mount Retry Count	3
Unmount Timeout (sec)	120
Unmount Retry Count	3
Unmount Retry Interval	5
Action at Unmount Failure	kill
Fsck Option	-y
Fsck Timeout (sec)	7200
Fsck Action Before Mount	Execute at Specified Count
Fsck Interval	10
Fsck Action When Mount Failed	Execute
Re-restoration of Reiserfs	None
Initial Mirror Recovery	Yes
Initial Mkfs	Yes
Synchronization Data	Yes
Synchronization Mode	Synchronous
Number of Queues	2048
Mode of Communication Band	No
Upper Bound of Communication Band(KB/sec)	Unlimited
Compress Data	No
Mirror Data Port Number	29052
Mirror Heartbeat Port Number	29032
Mirror ACK2 Port Number	29072
Send Timeout (sec)	30
Connection Timeout (sec)	10
ACK Timeout (sec)	100
Receive Timeout (sec)	100
Mirror Heartbeat Interval (sec)	10
ICMP Echo Reply Receive Timeout (sec)	2
ICMP Echo Request Retry Count	8
Disk type of Data Partition	HDD
Disk type of Cluster Partition	HDD
Xfs_repair Action	Execute
Xfs_repair Option	
Xfs_repair Timeout (sec)	7200

Name:	Hybrid disk resource name
Type:	Resource type
Failover Threshold:	Maximum number of times that failover is performed at an activation error
Retry Count at Activation Failure:	Maximum number of times that activation is retried at an activation error
Final Action at Activation Failure:	Final action at an activation error
Execute Script before Final Action:	Whether or not script is executed upon activation failure
Retry Count at Deactivation Failure:	Maximum number of times that inactivation is retried at an inactivation error
Final Action at Activation Failure:	Final action at an inactivation error
Execute Script before Final Action:	Whether or not script is executed upon deactivation failure
Dependent Resources:	Dependent resource
Mount Option:	Options to pass to the mount command when mounting a file system

Mount Timeout (sec):	Timeout for waiting for the completion of the mount command (in seconds)
Mount Retry Count:	Mount retry count when the mount command fails
Unmount Timeout (sec):	Timeout for waiting for the completion of the unmount command to (in seconds)
Unmount Retry Count:	Unmount retry count when the unmount command fails
Unmount Retry Interval:	Unmount retry interval (in seconds)
Action at Unmount Failure:	Action to be taken at an unmount error kill                   Force termination No Operation        No action
Fsck Option:	Options to be passed to the fsck command
Fsck Timeout:	Timeout for waiting for the completion of the fsck command (in seconds)
Fsck Action Before Mount:	fsck timing at mount <ul style="list-style-type: none"> <li>• Does not execute fsck</li> <li>• Always execute fsck</li> <li>• Executes fsck when reached to fsck interval</li> </ul>
Fsck Interval:	fsck interval
Fsck Action When Mount Failed:	Action when mount failed <ul style="list-style-type: none"> <li>• No operation</li> <li>• Executes fsck</li> </ul>
Reconstruction of Reiserfs	Action when reiserfsck failed <ul style="list-style-type: none"> <li>• No operation</li> <li>• Execute recovery by reiserfsck</li> </ul>
Initial Mirror Recovery:	Mirror recovery at cluster configuration
Initial Mkfs:	("Yes" is displayed, but it is not executed actually.)
Synchronization Data:	Synchronization of mirror data
Synchronization Mode:	Synchronization mode of mirror data
Number of Queues:	Number of queues used for asynchronous mirroring
Rate Limitation of Mirror Connect	Upper rate limitation of mirror connect (KB/second)
Mode of Communication Band:	Mode of communication band
Upper Bounds of Communication Band (KB/second):	Upper rate limitation of mirror connect (KB/second)
Compress Data:	Whether or not compressing mirror data at asynchronous mirroring and at mirror recovery
Mirror Data Port Number:	Data port number used for mirroring by hybrid disk
Mirror Heartbeat Port Number:	Heartbeat port number used for mirroring by hybrid disk
Mirror ACK2 Port Number:	Port number used for ACK2 of mirroring by hybrid disk
Send Timeout (sec):	Send timeout (in seconds)
Connection Timeout (sec):	Connection timeout (in seconds)
ACK Timeout (sec):	Timeout waiting for ACK response(in seconds)
Receive Timeout (sec):	Receive timeout waiting for writes confirmation (in seconds)
Mirror heartbeat interval (sec):	Mirror disk connect heartbeat interval (in seconds)
ICMP Echo Reply Receive Timeout (sec):	ICMP Echo Reply receive timeout for the mirror disk connect (in seconds)
ICMP Echo Request Retry Count	The maximum send count for ICMP Echo Request of the mirror disk connect
Disk type of Data Partition	Disk type of data partition
Disk type of Cluster Partition	Disk type of cluster partition
Xfs_repair Action When Mount Failed	Action to be taken at a mount error <ul style="list-style-type: none"> <li>• No action</li> <li>• Perform xfs_repair</li> </ul>

Xfs\_repair Option:

Xfs\_repair Timeout (sec):

Options passed to the xfs\_repair command

Timeout for the xfs\_repair command execution (in seconds)

# Understanding NAS resource

## Dependencies of the NAS resource

By default, this function depends on the following group resource type:

Group resource type
Dynamic DNS resource
Floating IP resource
Virtual IP resource
AWS elastic ip resource
AWS virtual ip resource
Azure probe port resource

## NAS resource

- ◆ The NAS resource controls the resources in the NFS server.
- ◆ By storing the data that is necessary for business transactions in the NFS server, it is automatically passed on when the failover group is moving during failover.

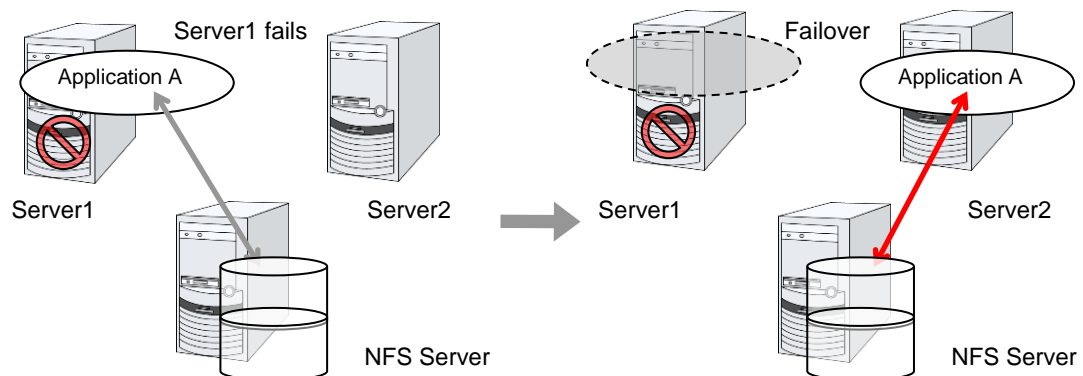

## Notes on NAS resource

- ◆ The EXPRESSCLUSTER will control the access (mount and/or umount) to the file system. Thus, do not configure the settings for the OS to run the mount or umount command.
- ◆ On the NFS server, it is necessary to configure the settings that allow servers in the cluster for access to NFS resources.
- ◆ On the EXPRESSCLUSTER X, configure the settings that start the portmap service.
- ◆ If the host name is specified as the NAS server name, make the settings for name resolving.
- ◆ If **Mount/Unmount Exclusion** is selected on the **Exclusion** tab of the **Cluster Properties**, it may take some time to activate or deactivate the VxVM volume resource because the mount or unmount of the disk resource, VxVM resource, NAS resource, and mirror resource is performed exclusively in the same server.

- ◆ When specifying path including symbolic link for mount point, Force Operation cannot be done even if it is chosen as operation in Detecting Failure. Similarly, if a path containing “//” is specified, forced termination will also fail.



## Displaying and changing the details of NAS resource

1. From the tree view displayed in the left pane of the window, click the icon of the group to which the NAS resource whose detailed information and settings you want to display and/or change belongs.
2. The group resource list is displayed on the table view in the right pane of the window. Right-click the desired NAS resource name, and then click **Properties** on the shortcut menu. Click the **Details** tab in the properties dialog box.
3. Display and/or change the detailed settings on the **Details** tab as described below.

### NAS resource: Detail tab

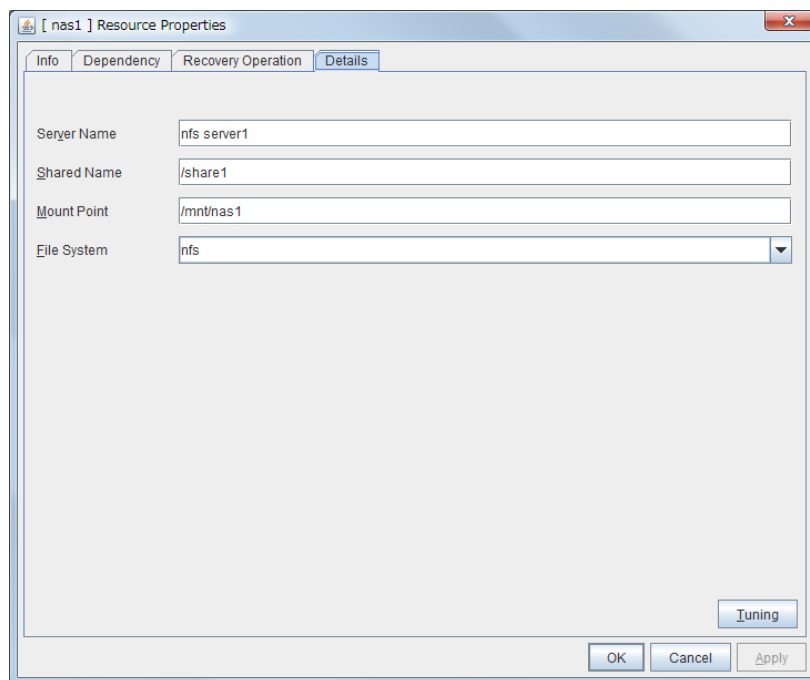

**Server Name** Up to 255 bytes

Enter the IP address or the server name of the NFS. If you set the host name, set the name resolution to OS. (ex. By adding entry to /etc/hosts)

**Shared Name** Up to 1023 bytes

Enter the share name on the NFS server.

**Mount Point** Up to 1023 bytes

Enter the directory where the NFS resource will be mounted. This must start with “/.”

**File System** Up to 15 bytes

Enter the type of file system of the NFS resource. You may also directly enter the type.

- ◆ nfs

**Tuning**

Displays the **NAS Resource Tuning Properties** dialog box. Configure the NAS resource detailed settings.

**NAS Resource Tuning Properties****Mount tab**

The advanced settings for mounting are displayed.

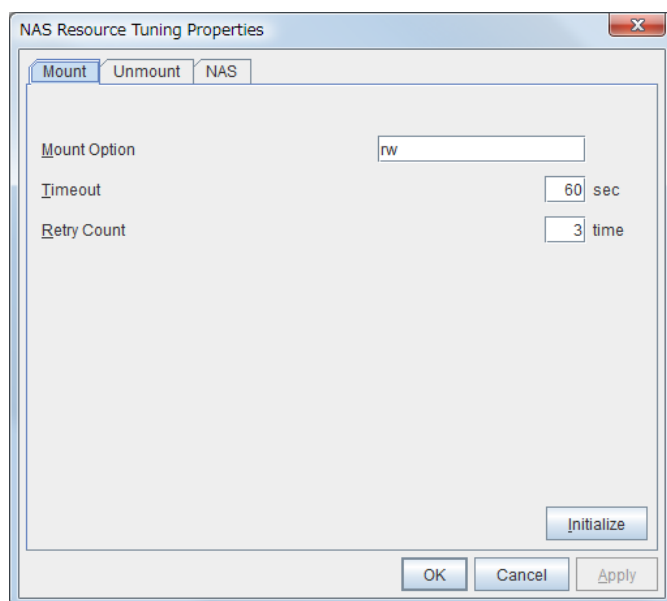
**Mount Option** Up to 1023 bytes

Enter the option that is passed to the mount command when mounting a file system. If you are entering more than one option, use “,” to separate them.

Examples of the mount option

Setting item	Setting value
Server Name	nfserver1
Shared Name	/share1
Mount Point	/mnt/nas1
File System	nfs
Mount Option	rw

The mount command that is run when the option shown above is set:

```
mount -t nfs -o rw nfserver1:/share1 /mnt/nas1
```

**Timeout** 1 to 999

Set the timeout to wait the mount command to be completed when mounting a file system.

It may take a while depending on how heavily network is loaded. Be careful when you are setting the value as the timeout may be detected while a command is running when you set a small value.

**Retry Count** 0 to 999

Set the number of mount retries when mounting the file system fails. When zero is set, mounting is not retried.

**Initialize**

Clicking **Initialize** resets the values of all items to the default values.

**Unmount tab**

The advanced settings for unmounting are displayed.

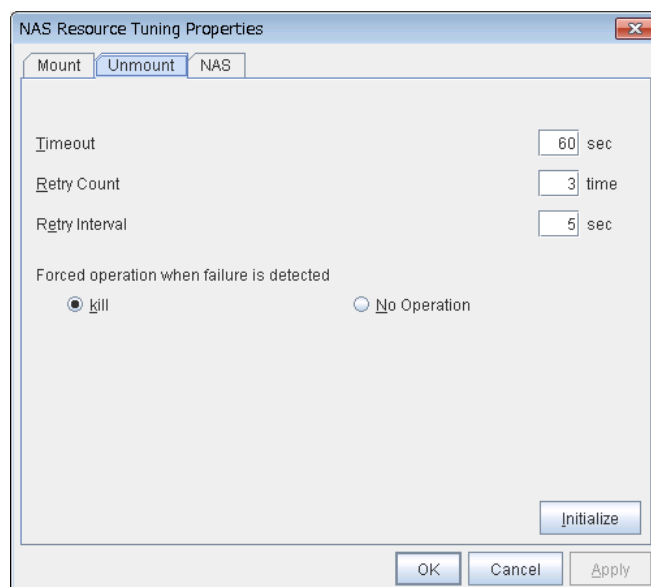
**Timeout** 1 to 999

Set the timeout that waits for the end of the umount command when unmounting a file system.

**Retry Count** 0 to 999

Set the number of unmount retries to be made when unmounting the file system fails. When zero is set, unmounting is not retried.

**Retry Interval** 0 to 999

Enter the interval in which you want to retry unmounting the file system when unmounting fails.

### Forced operation when error is detected

Select an action to be taken when retrying unmount after unmount fails from the following.

- ◆ **kill:**  
Attempts the forceful termination of the process that is accessing the mount point. This does not always mean that the processes can be forcibly terminated.
- ◆ **none:**  
Does not attempt the forceful termination of the process that is accessing the mount point.

### Initialize

Clicking **Initialize** resets the values of all items to the default values.

### NAS tab

The advanced settings for NAS are displayed.

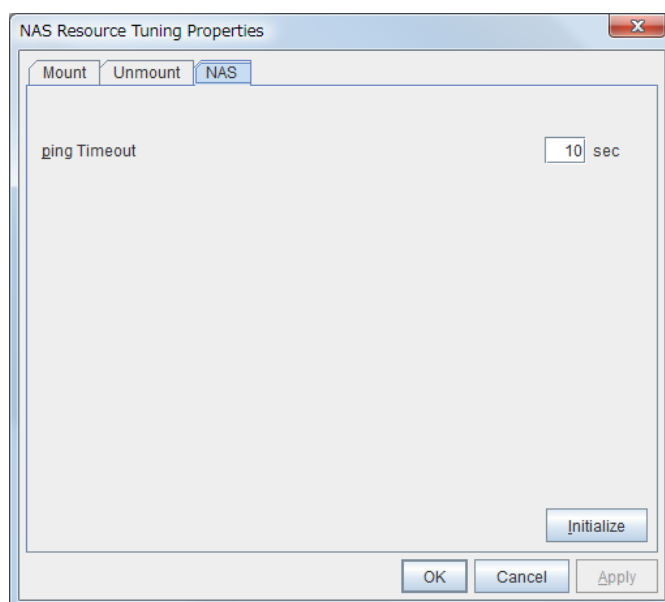

### Ping Timeout 0 to 999

Set timeout of the ping command is used to check the connection with the server when activating and deactivating NAS resources. If zero is specified, the ping command is not is used.

### Initialize

Clicking **Initialize** sets all the items to their default values.

## Displaying the property of NAS resource with the WebManager

1. Start the WebManager.
2. When you click an object for the NAS resource  in the tree view, the following information is displayed in the list view.

NAS Name: nas1		Details
Common		server1
server2		
Properties	Value	
Comment		
Server Name	nfs server1	
Shared Name	/share1	
File System	nfs	
Mount Point	/mnt/nas1	
Status	Online	
Started Server	server1	

Comment:	NAS resource comment
Server Name:	NFS server name
Shared Name:	NFS share name
File System:	NFS file system
Mount Point:	Directory to mount NFS
Status:	NAS resource status
Started Server	Server name

If you click **Details**, the following information is displayed.

Properties	Value
Name	nas1
Type	nas
Failover Threshold	1
Retry Count at Activation Failure	0
Final Action at Activation Failure	No operation (not activate next resource)
Execute Script before Final Action	Off
Retry Count at Deactivation Failure	0
Final Action at Deactivation Failure	Stop the cluster service and shutdown OS
Execute Script before Final Action	Off
Depended Resources	
Mount Option	rw
Mount Timeout (sec)	60
Mount Retry Count	3
Unmount Timeout (sec)	60
Unmount Retry Count	3
Unmount Retry Interval	5
Action at Unmount Failure	kill
Ping Timeout (sec)	10

Name:	NAS resource name
Type:	Resource type
Failover Threshold:	Maximum number of times that failover is performed when an activation error is detected
Retry Count at Activation Failure:	Maximum number of times that activation is retried when an activation error is detected
Final Action at Activation Failure:	Final action at an activation error
Execute Script before Final Action:	Whether or not script is executed upon activation failure
Retry Count at Deactivation Failure:	Maximum number of times that inactivation is retried when a inactivation error is detected
Final Action at Deactivation Failure:	Final action at a inactivation error
Execute Script before Final Action:	Whether or not script is executed upon deactivation failure
Depended Resources:	Dependent resource
Mount Option:	Options to be passed to the mount command when mounting a file system
Mount Timeout (sec):	Timeout for waiting for the mount command to complete (in seconds)
Mount Retry Count:	Number of times mounting is retried when the mount command fails
Unmount Timeout (sec):	Timeout for waiting for the umount command to complete (in seconds)
Unmount Retry Count:	Number of times unmounting is retried when the umount command fails
Unmount Retry Interval:	Unmount retry interval (in seconds)
Action at Unmount Failure:	Action at an unmount error
Ping Timeout (sec):	Timeout of ping which checks for redundancy (in seconds)

# Understanding volume manager resources

## Dependencies of volume manager resources

The volume manager resources depend on the following group resource types by default.

Group resource type
Dynamic DNS resource
Floating IP resource
Virtual IP resource
AWS elastic ip resource
AWS virtual ip resource
Azure probe port resource

## What is a Volume Manager Resource?

- ◆ The volume manager is disk management software that handles multiple storage devices and disks as one logical disk.
- ◆ Volume manager resources control logical disks managed by the volume manager.
- ◆ If data necessary for operation is stored in a logical disk, it is automatically taken over, for example, when there is a failover or a failover group is moved.

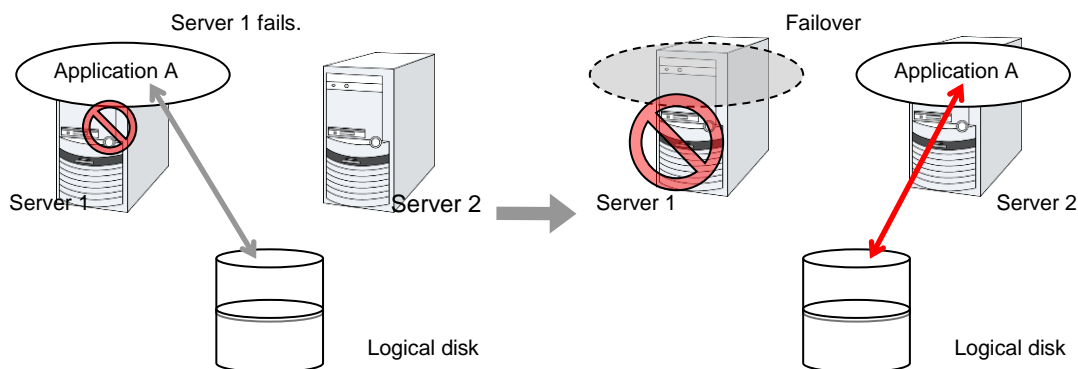

## Notes on volume manager resources

### <General>

- ◆ Do not use volume manager resources to manage a mirror disk.
- ◆ Disk resources control each volume.
- ◆ Do not specify the import or export settings on the OS because EXPRESSCLUSTER performs access control (importing or exporting) for logical disks.

### <Notes on using resources with the volume manager LVM>

- ◆ Volume groups are not defined on the EXPRESSCLUSTER side.
- ◆ At least one disk resource is required because each volume must be controlled.
- ◆ The volume groups included in the EXPRESSCLUSTER configuration data are automatically exported when the OS is started.
- ◆ Other volume groups are not exported.
- ◆ When a VG created by using a shared disk is specified as a target volume, the import/export status of the VG is recorded on the shared disk according to the LVM specification. Therefore, if activation (import) or deactivation (export) is performed on the active server, it might be assumed that the same operation is performed on the standby server.
- ◆ When controlling the LVM by using the volume manager resource in an environment of Red Hat Enterprise Linux 7 or later, the LVM metadata daemon must be disabled.
- ◆ Run the following commands when activating resource.

Command	Option	Timing when using command
	-P	Verifying volume group status
vgs	--noheadings	Verifying volume group status
	-o vg_attr,vg_name	Verifying volume group status
vgimport	(Nothing)	Importing volume group
vgscan	(Nothing)	Activating volume group
vgchange	-ay	Activating volume group



◆ The resource activation sequence is shown below.

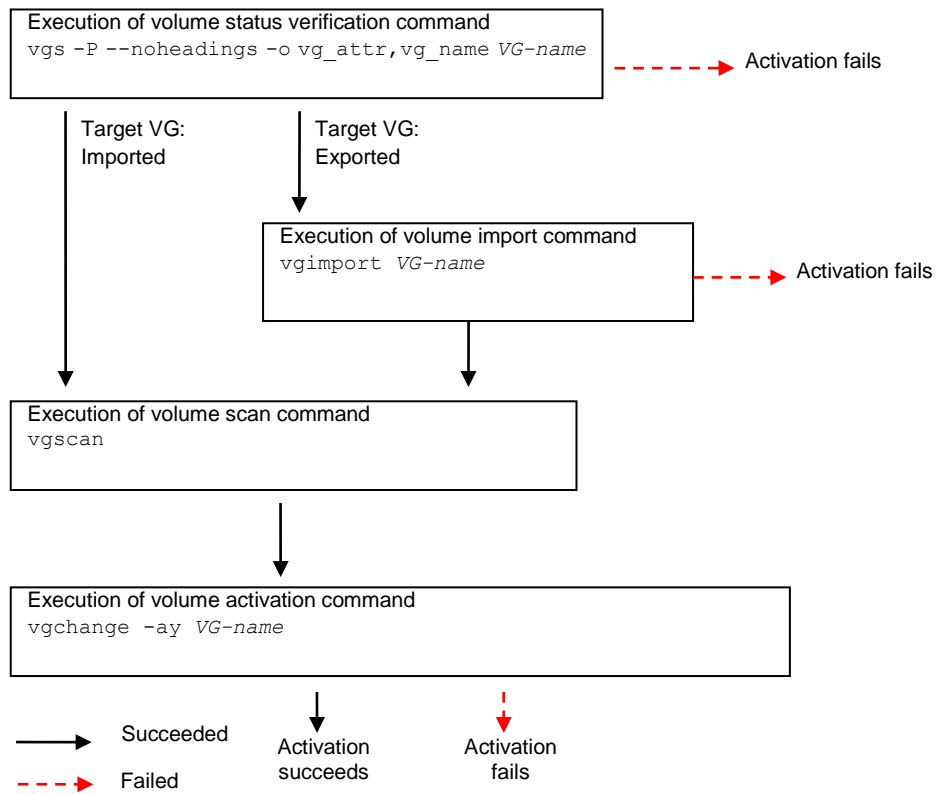

- ◆ Run the following commands when deactivating resource.

Command	Option	Timing when using command
vgs	-P	Verifying volume group status
	--noheadings	Verifying volume group status
	-o vg_attr,vg_name	Verifying volume group status
vgchange	-an	Deactivating volume group
vgexport	(Nothing)	Exporting volume group

- ◆ The resource deactivation sequence is shown below.

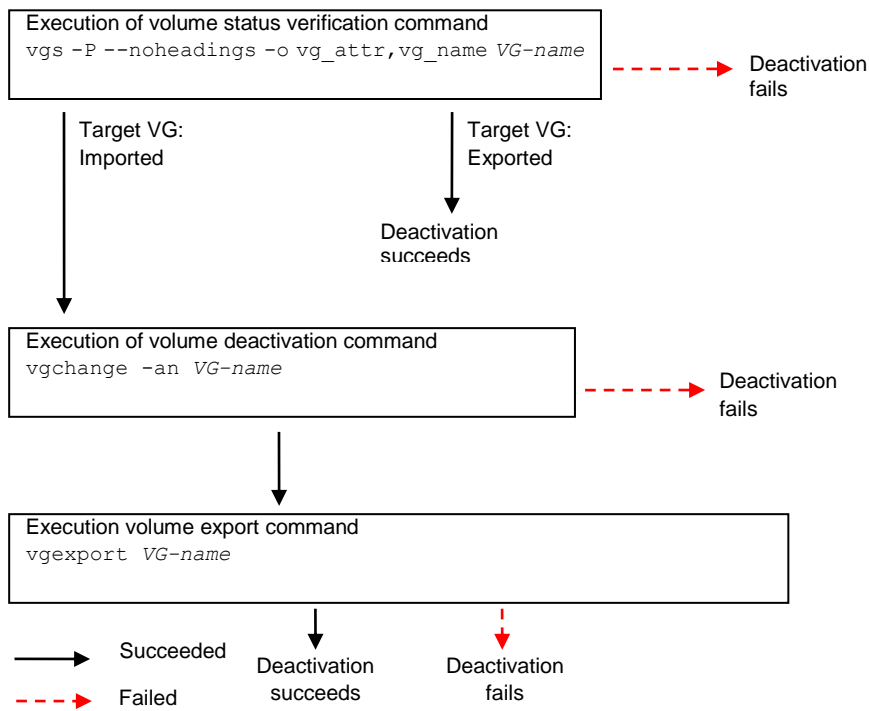

**<Notes on using resources with the volume manager VxVM>**

- ◆ Disk groups are not defined on the EXPRESSCLUSTER side.
- ◆ The disk groups included in the EXPRESSCLUSTER configuration data are automatically deported when the OS is started.
- ◆ Other disk groups are not deported.
- ◆ If the **Clear host ID** option is not selected, disk groups cannot be imported to the failover destination server due to VxVM specifications if the failover source server fails to normally deport the disk groups.
- ◆ Even if an import timeout occurs, importing might be successfully completed. This problem can be avoided by specifying the **Clear host ID** or **Forced Option at Import** option, which retries importing.
- ◆ Run the following commands when activating a resource.

Command	Option	When to use
	import	When importing a disk group
	-t	When importing a disk group
vxdg	-C	When importing a disk group fails and the <b>Clear host ID</b> option is selected
	-f	When importing a disk group fails and the <b>Forced Activation</b> option is selected

Command	Option	When to use
	-g	When the volume for the specified disk group is started
vxrecover	-sb	When the volume for the specified disk group is started

- ◆ The resource activation sequence is shown below.

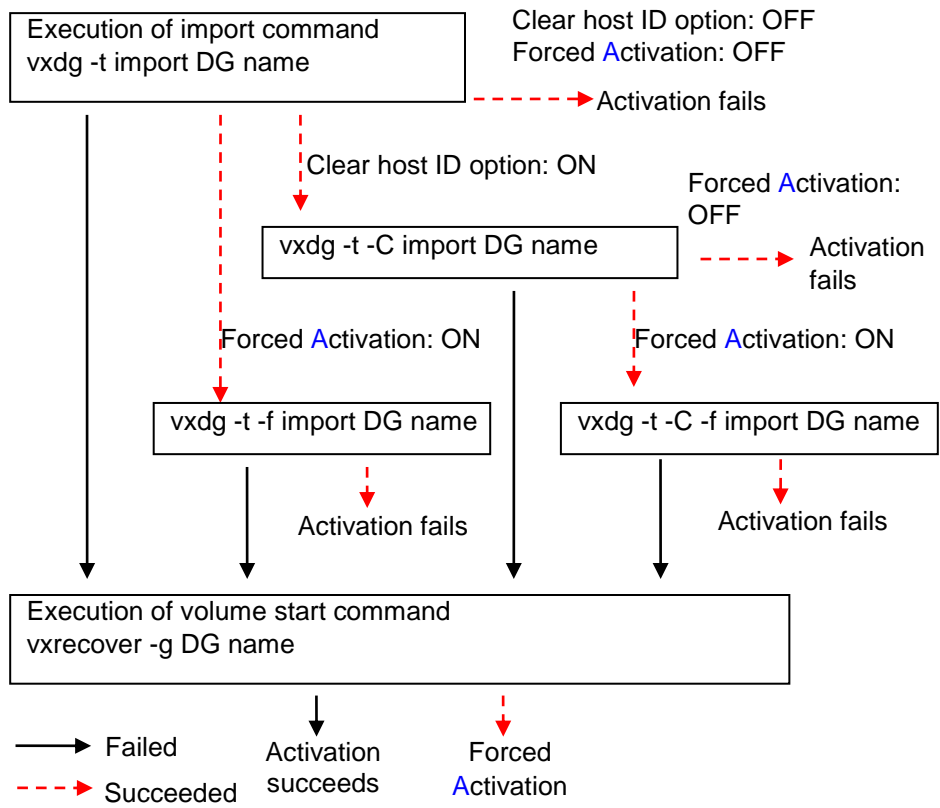

- ◆ Run the following commands when activating a resource.

Command	Option	When to use
vxdg	deport	When deporting a disk group
	flush	When flushing data

Command	Option	When to use
vxvol	-g	When the volume of the specified disk group is stopped
	stopall	When the volume of the specified disk group is stopped

- ◆ The resource deactivation sequence is shown below.

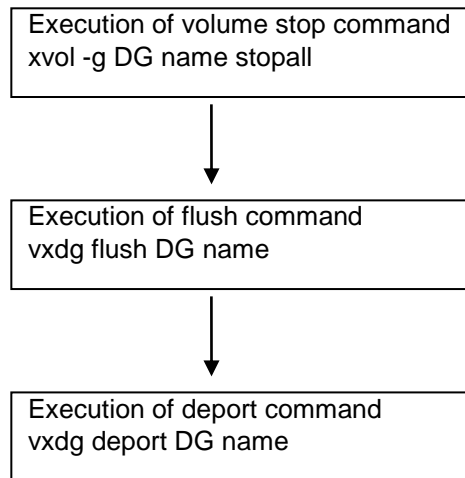

## Displaying and changing the details of the volume manager resources

1. In the tree view displayed in the left pane of the Builder, click the icon of the group to which the volume manager resource whose details you want to display or change belong.
2. The group resource list is displayed in the table view in the right pane of the window. Right-click the target volume manager resource name, and then click the **Details** tab in **Property**.
3. Display or change the detailed settings on the **Details** tab as described below.

### Volume Manager Resource Details Tab

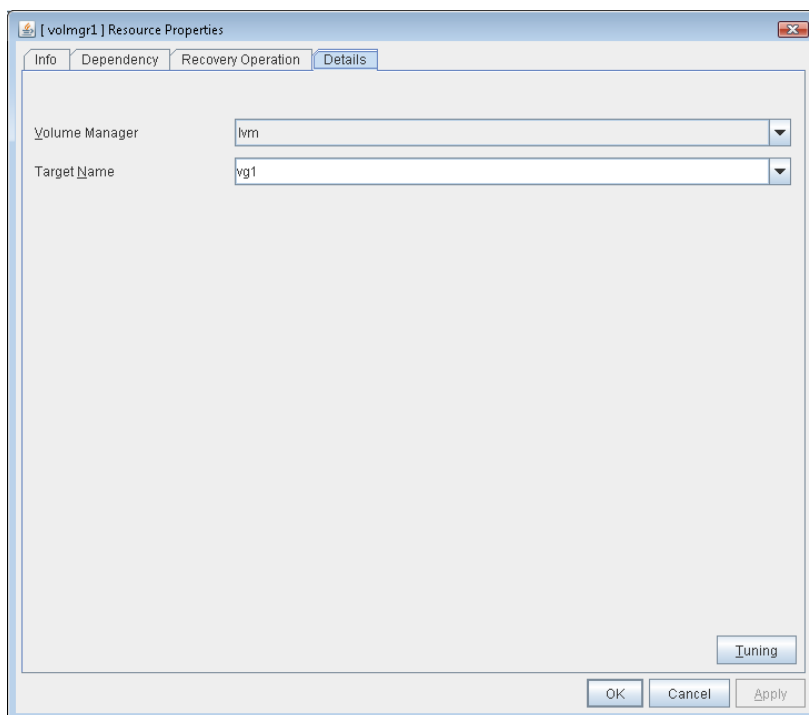

### Volume Manager

Specify the volume manager to use. The following volume managers can be selected:

- ◆ lvm (LVM volume group control)
- ◆ vxvm (VxVM disk group control)

### Target Name(within 1023 bytes)

Specify the volume name in the <VG name> format (only the target name is used).

Combo box options collect volume group information from all the servers and display all the volume groups on one or more servers.

When the volume manager is lvm, it's possible to control multiple volumes together. More than one volume is delimited with an one-byte space.

## Tuning

This displays the **Volume Manager Resource Tuning Properties** dialog box. Specify detailed settings for the volume manager resource.

### Volume Manager Resource Tuning Properties

#### Import Tab

The detailed import settings are displayed.

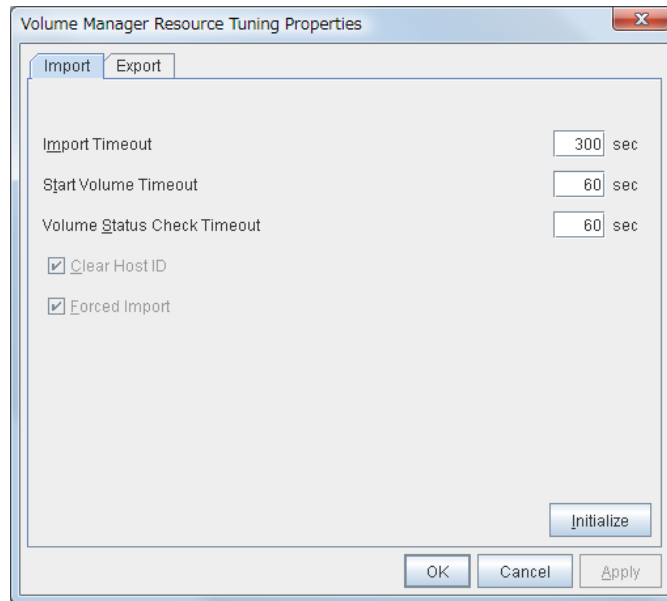

#### Import Timeout (1 to 999)

Specify how long the system waits for completion of the volume import command before it times out.

#### Start Volume Timeout (1 to 9999)

Specify the startup command timeout.

#### Volume Status Check Timeout (1 to 9999)

Specify the volume status check command timeout.

This option can be used when the volume manager is **lvmm**.

#### Clear Host ID

When normal importing fails, the clear host ID flag is set and importing is retried. The host ID is cleared when the check box is selected.

This option can be used when the volume manager is **vxvm**.

#### Forced Import

Specify whether to forcibly import data when importing fails. Data is forcibly imported if the check box is selected.

This option can be used when the volume manager is **vxvm**.

### Initialize

Clicking **Initialize** resets the values of all items to the defaults.

### Export Tab

The detailed export settings are displayed.

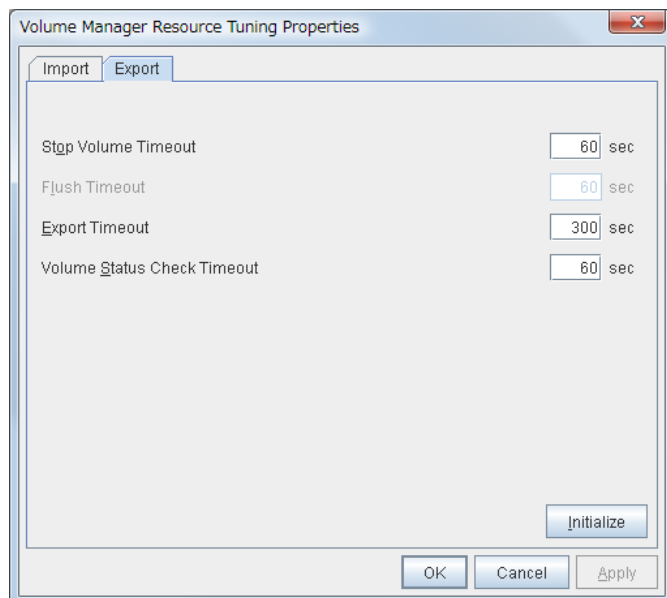

### Stop Volume Timeout (1 to 9999)

Specify the volume deactivation command timeout.

### Flush Timeout (1 to 9999)

Specify the flush command timeout.

This option can be used when the volume manager is **vxvm**.

### Export Timeout (1 to 9999)

Specify the export/deport command timeout.

### Volume Status Check Timeout (1 to 9999)

Specify the volume status check command timeout.

This option can be used when the volume manager is **lvm**.

### Initialize

Clicking **Initialize** resets the values of all items to the defaults.



## Displaying the properties of a volume manager resource by using the WebManager

1. Start the WebManager.
2. In the tree view, click the object icon  for a volume manager resource. The following information is displayed in the list view.

Volume Manager Name: volmgr1		Details
Common		server1
server2		
Properties	Value	
Comment		
Volume Manager	lvm	
Target	volume1	
Status	Online	
Started Server	server1	

Comment:

Volume Manager:

Target Name:

Status:

Started Server:

Comment on the volume manager resource

Type of volume manager

Target name

Status of the volume manager resource

Name of the server

When you click **Details**, the following information is displayed.

Properties	Value
Name	volmgr1
Type	volmgr
Failover Threshold	1
Retry Count at Activation Failure	5
Final Action at Activation Failure	No operation (not activate next resource)
Execute Script before Final Action	Off
Retry Count at Deactivation Failure	5
Final Action at Deactivation Failure	Stop the cluster service and shutdown OS
Execute Script before Final Action	Off
Depended Resources	
Import Timeout (sec)	300
Start Volume Timeout (sec)	60
Clear Host ID	On
Force Import	On
Export Timeout (sec)	300
Flush Timeout (sec)	60
Stop Volume Timeout (sec)	60
Force Export	On
Check Volume Status Timeout of Activating (sec)	60
Check Volume Status Timeout of Deactivating (sec)	60

- Name: Volume manager resource name
- Type: Resource type
- Failover: Threshold Maximum number of times failing over is performed when an activation error is detected
- Retry Count at Activation Failure: Maximum number of times activation is retried when an activation error is detected
- Final Action at Activation: Final action when an activation error occurs
- Execute Script before Final Action: Whether to execute scripts when an error is detected
- Retry Count at Deactivation Failure: Maximum number of times deactivation is retried when a deactivation error is detected
- Final Action at Deactivation: Final action when a deactivation error occurs
- Execute Script before Final Action: Whether to execute scripts when an error is detected
- Depended Resources: Dependent resource
- Import Timeout (in seconds): How long to wait for the import command to finish before timing out (in seconds)
- Start Volume Timeout (in seconds): Start command timeout (in seconds)
- Clear host ID: Import execution setting for clearing the host ID when importing fails
- Force Option at Import: Forced import execution setting for when importing fails
- Export Timeout (in seconds): How long to wait for the export command to finish
- Flush Timeout (in seconds): Flush command timeout (in seconds)
- Stop Volume Timeout (in seconds): Volume deactivation command timeout (in seconds)
- Force Option at Export: Forced export execution setting for when exporting fails
- Check Volume Status Timeout of Activating (in seconds): Volume status check command timeout when the resource activation (in seconds)
- Check Volume Status Timeout of Deactivating (in seconds): Volume status check command timeout when the resource deactivation (in seconds)

# Understanding VM resources

## Dependencies of VM resources

VM resources do not depend on any group resource type by default.

## What is a VM resource?

The VM resources control the virtual machines (guest OSs) in the virtualization infrastructure.

The management OS under which EXPRESSCLUSTER is installed starts and stops the virtual machines. For vSphere, EXPRESSCLUSTER can be installed and used under the guest OS of the virtual machine which was prepared for management.

Migration of the virtual machines can also be performed. If, however, vSphere is used, the configuration must also use vCenter.

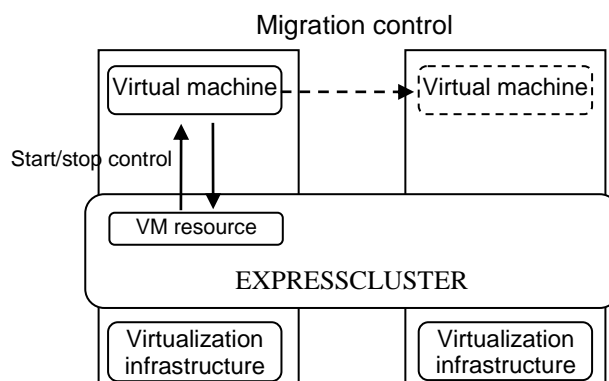

**Fig. 1 : Configuration when EXPRESSCLUSTER is installed under the management OS for the virtualization infrastructure**

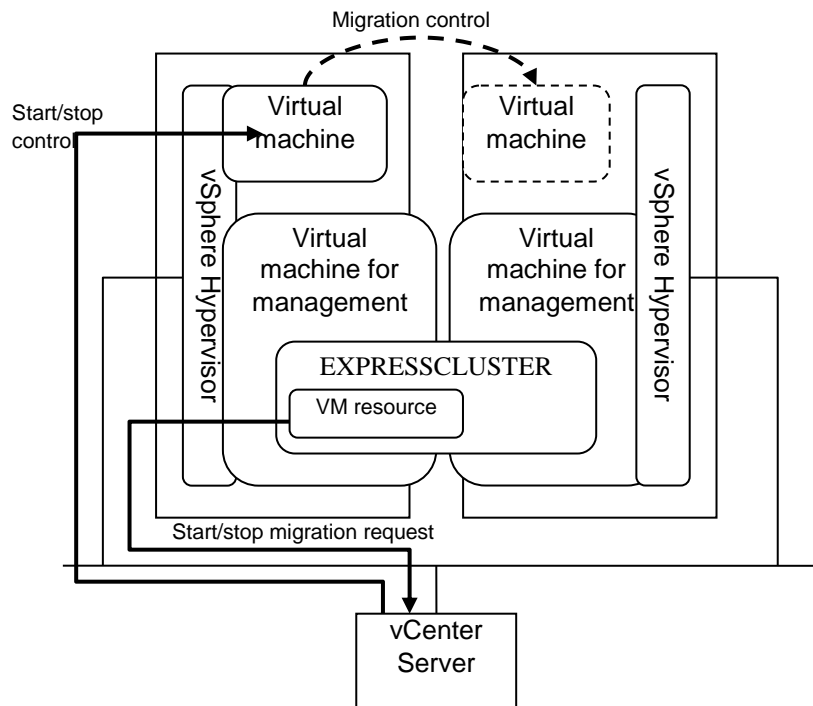

**Fig. 2 : Configuration when EXPRESSCLUSTER is installed under the OS on a virtual machine for management (vSphere only)**

## Notes on VM resources

- ◆ If the virtualization infrastructure type is XenServer or KVM, the VM resources are valid only when EXPRESSCLUSTER is installed under the host OS in the virtualization infrastructure.
- ◆ If the virtualization infrastructure type is vSphere, the VM resources can be used even if EXPRESSCLUSTER is installed under the guest OS. In this case, however, vCenter must always be used.
- ◆ A VM resource can be registered with a group for which the group type is virtual machine.
- ◆ Only one VM resource can be registered per group.
- ◆ If vSphere is selected as the virtualization infrastructure, **Use vCenter** must be selected (on) to perform migration.
- ◆ Confirm the start time of the virtual machine (guest OS) to be controlled with a virtual machine resource, and set **Virtual Machine Start Wait Time** of **Virtual Machine Resource Adjustment Property**.  
The default value of **Virtual Machine Start Wait Time** is 0 seconds, so if it is not changed, the virtual machine monitor resource may mistakenly detect a monitor error.

## Displaying and changing the details of the VM resources

1. From the tree view displayed in the left pane of the Builder, click the icon of the group to which the VM resource whose details you want to display or change belongs.
2. The group resource list is displayed in the table view in the right pane of the window. Right-click the target VM resource name, and then click the **Details** tab in **Property**.
3. Display or change the detailed settings on the **Details** tab as described below.

### Resource Details Tab (for vSphere)

The screenshot shows the 'vm1 | Resource Properties' dialog box with the 'Details' tab selected. The 'Common' sub-tab is active, showing configuration fields for a vSphere VM. The fields are as follows:

Field Name	Value
Virtual Machine Type	vSphere
Installation Destination of the Cluster Service	Host
Virtual Machine Name	vSphere
Data Store Name	datastore
VM Configuration File Path	/vm
IP Address of Host	
UUID	
Library Path	
User Name	user1
Password	*****
Use vCenter	<input type="checkbox"/>
vCenter	
User Name for vCenter	
Password for vCenter	
Resource Pool Name	

Buttons: Change (next to Password), Change (next to Password for vCenter), Tuning, OK, Cancel, Apply.

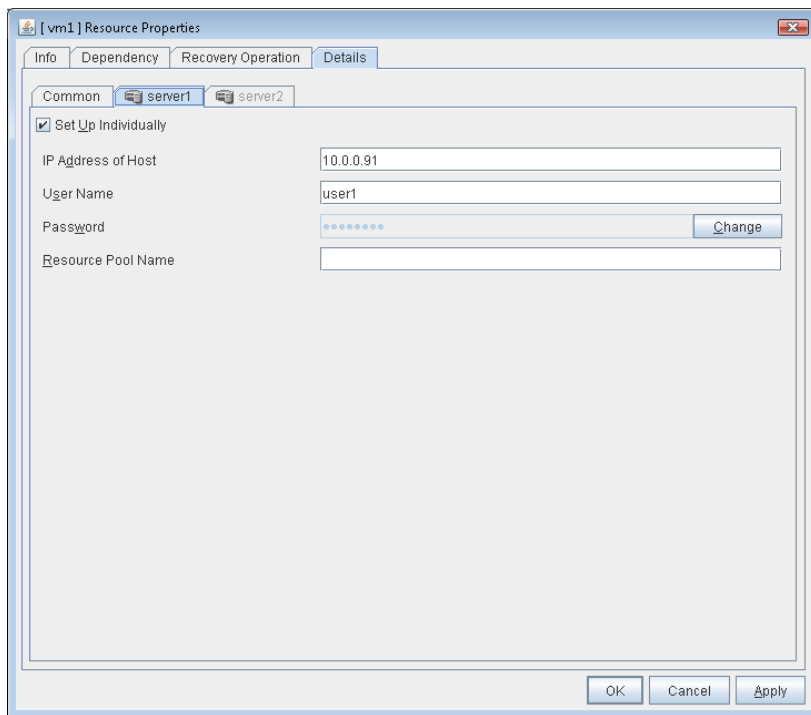

**Virtual Machine Type**

Specify the virtualization infrastructure type.

**Installation Destination of the Cluster Service**

Specify the type of OS under which EXPRESSCLUSTER is installed. Selecting the guest OS automatically selects the **Use vCenter** check box.

**Virtual Machine Name** (within 255 bytes)

Enter the virtual machine name. This setting is not required if the virtual machine path is entered. Specify the virtual machine path if the virtual machine name might be changed in the virtualization infrastructure.

**Data Store Name** (within 255 bytes)

Specify the name of data store containing the virtual machine configuration information.

**VM Configuration File Path** (within 1,023 bytes)

Specify the path where the virtual machine configuration information is stored.

**IP Address of Host** **Server Individual Setup**

Specify the management IP address of the host. You must specify the IP address of host for each server, using individual server settings.

**User Name** (within 255 bytes) **Server Individual Setup**

Specify the user name used to start the virtual machine.

**Password** (within 255 bytes) **Server Individual Setup**

Specify the password used to start the virtual machine.

**Use vCenter**

Specify whether to use vCenter. Use vCenter when performing migration.

**vCenter** (within 1,023 bytes)

Specify the vCenter host name.

**User Name for vCenter** (within 255 bytes)

Specify the user name used to connect to vCenter.

**Password for vCenter** (within 255 bytes)

Specify the password used to connect to vCenter.

**Resource Pool Name** (within 80 bytes) **Server Individual Setup**

Specify the resource pool name for starting the virtual machine.

**Tuning**

This displays the **VM Resource Tuning Properties** dialog box. Specify detailed settings for the VM resource.

### Resource Details Tab (for XenServer)

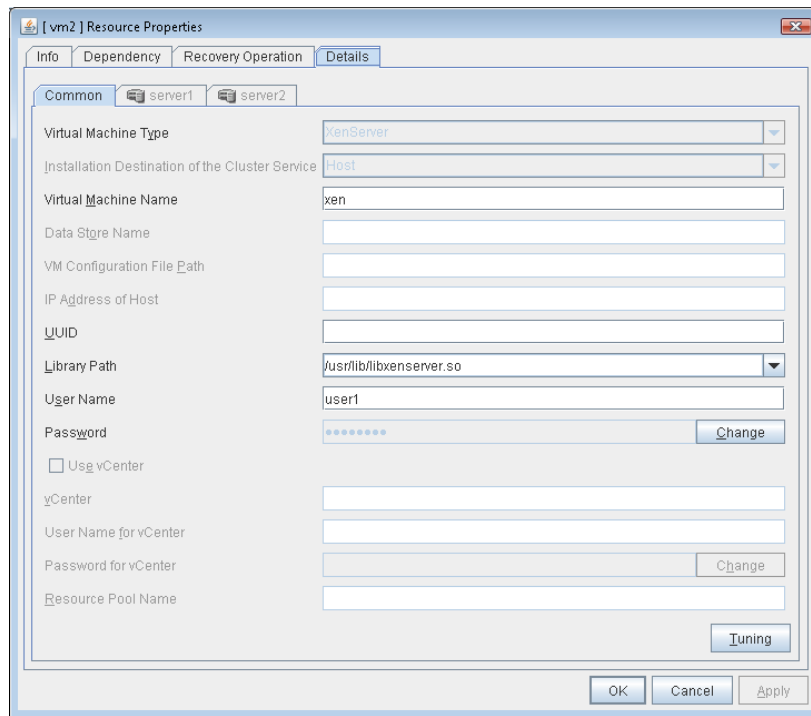

#### Virtual Machine Type

Specify the virtualization infrastructure type.

#### Virtual Machine Name (within 255 bytes)

Enter the virtual machine name. This setting is not required if the UUID is specified. Specify the UUID if the virtual machine name might be changed in the virtualization infrastructure.

#### UUID

Specify the UUID (Universally Unique Identifier) for identifying the virtual machine.

#### Library Path (within 1,023 bytes)

Specify the library path used to control XenServer.

#### User Name (within 255 bytes)

Specify the user name used to start the virtual machine.

#### Password (within 255 bytes)

Specify the password used to start the virtual machine.

#### Tuning

This displays the **VM Resource Tuning Properties** dialog box. Specify detailed settings for the VM resource.



### Resource Details Tab (for KVM)

The screenshot shows the 'Resource Properties' dialog box for a KVM virtual machine. The 'Details' tab is selected, and the 'Common' sub-tab is active. The fields are as follows:

- Virtual Machine Type: KVM
- Installation Destination of the Cluster Service: Host
- Virtual Machine Name: kvm
- Data Store Name: (empty)
- VM Configuration File Path: (empty)
- IP Address of Host: (empty)
- UUID: (empty)
- Library Path: /usr/lib64/libvirt.so.0.6.3
- User Name: (empty)
- Password: (empty) with a 'Change' button
- Use vCenter
- vCenter: (empty)
- User Name for vCenter: (empty)
- Password for vCenter: (empty) with a 'Change' button
- Resource Pool Name: (empty)

Buttons at the bottom include 'OK', 'Cancel', 'Apply', and a 'Tuning' button.

#### Virtual Machine Type

Specify the virtualization infrastructure type.

#### Virtual Machine Name (within 255 bytes)

Enter the virtual machine name. This setting is not required if the UUID is specified.

#### UUID

Specify the UUID (Universally Unique Identifier) for identifying the virtual machine.

#### Library Path (within 1,023 bytes)

Specify the library path used to control KVM.

#### Tuning

This displays the **VM Resource Tuning Properties** dialog box. Specify detailed settings for the VM resource.

## Adjusting the VM resource

1. Click **Tuning** on the **VM Resource** tab.
2. Display the **VM Resource Tuning Properties** screen. Display or change the detailed settings as described below.

### VM Resource Tuning Properties

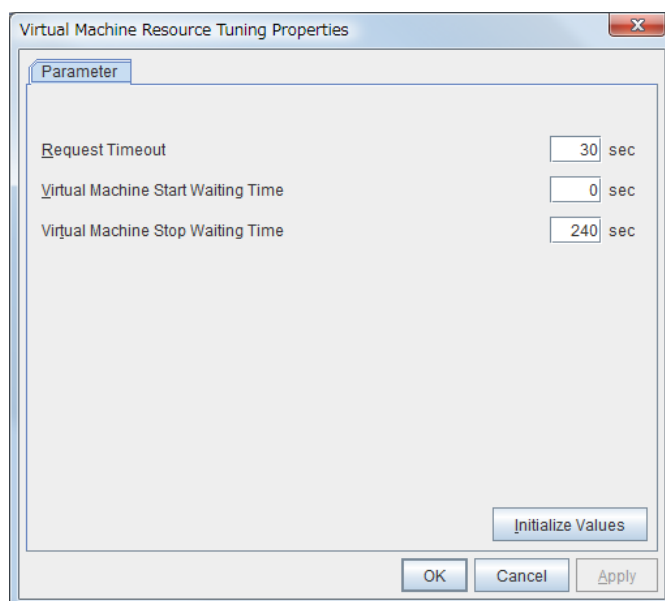

#### Request Timeout

Specify how long the system waits for completion of a request such as to start or stop a virtual machine.

If the request is not completed within this time, a timeout occurs and resource activation or deactivation fails.

#### Virtual Machine Start Waiting Time

The system definitely waits this time after requesting the virtual machine to startup.

#### Virtual Machine Stop Waiting Time

The maximum time to wait for the stop of the virtual machine. Deactivation completes at the timing the stop of the virtual machine.

## Displaying the properties of a VM resource by using the WebManager

1. Start the WebManager.
2. Click an object for virtual machine resource  in the tree view. The following information is displayed in the list view.

### When the virtualization infrastructure type is vSphere

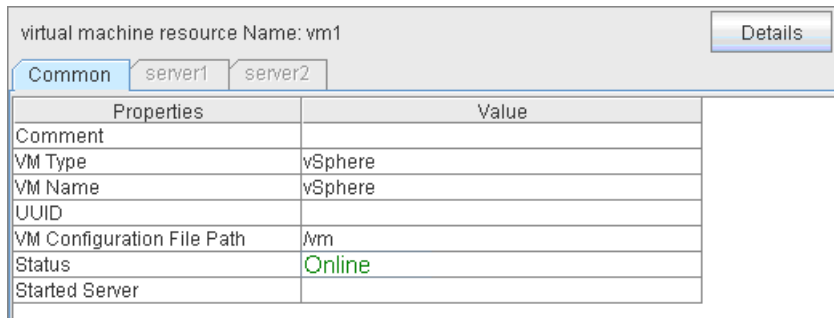

Properties	Value
Comment	
VM Type	vSphere
VM Name	vSphere
UUID	
VM Configuration File Path	/vm
Status	Online
Started Server	

Comment:	Comment on the VM resource
Virtual Machine Type:	Virtualization infrastructure type
Virtual Machine Name:	Virtual machine name
UUID:	UUID for identifying the virtual machine
VM Configuration File Path:	Path of the virtual machine configuration information
Status:	Status of VM resources
Started Server:	Started Server name

### When the virtual machine type is XenServer

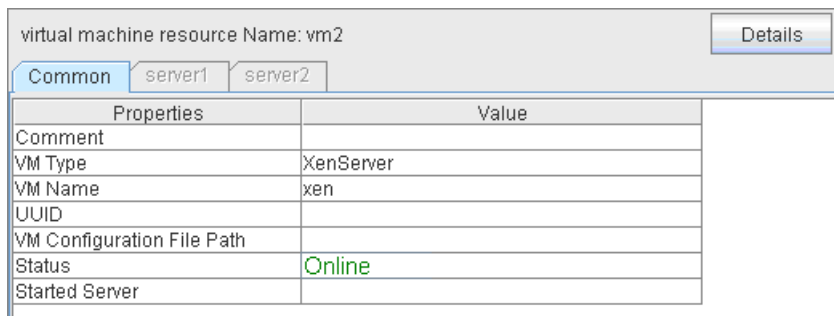

Properties	Value
Comment	
VM Type	XenServer
VM Name	xen
UUID	
VM Configuration File Path	
Status	Online
Started Server	

Comment:	Comment on the VM resource
Virtual Machine Type:	Virtualization infrastructure type
Virtual Machine Name:	Virtual machine name
UUID:	UUID for identifying the virtual machine
VM Configuration File Path:	Path of the virtual machine configuration information
Status:	Status of VM resources
Started Server:	Started Server name

**When the virtual machine type is KVM**

Properties	Value
Comment	
VM Type	KVM
VM Name	kvm
UUID	
VM Configuration File Path	
Status	Online
Started Server	

- Comment: Comment on the VM resource
- Virtual Machine Type: Virtualization infrastructure type
- Virtual Machine Name: Virtual machine name
- UUID: UUID for identifying the virtual machine
- VM Configuration File Path: Path of the virtual machine configuration information
- Status: Status of VM resources
- Started Server: Started Server name

3. Clicking **Details** also displays the following information in the popup dialog box:

**When the virtual machine type is vSphere**

Properties	Value
Name	vm1
Type	vm
Failover Threshold	1
Retry Count at Activation Failure	0
Final Action at Activation Failure	No operation (not activate next resource)
Execute Script before Final Action	Off
Retry Count at Deactivation Failure	0
Final Action at Deactivation Failure	Stop the cluster service and shutdown OS
Execute Script before Final Action	Off
Depended Resources	
Library Path	
vCenter	
Resource pool name	
Datastore Name	datastore
IP Address of Host	
Timeout Of Request	30
Timeout Of Start	0
Timeout Of Stop	240

- Name: Virtual machine resource name
- Type: Resource type
- Failover Threshold: Maximum number of times failing over is performed when an activation error is detected
- Retry Count at Activation Failure: Maximum number of times activation is retried when an activation error is detected
- Final Action at Activation Failure: Final action when an activation error occurs
- Execute Script before Final Action: Whether to execute scripts when an error is detected
- Retry Count at Deactivation Failure: Maximum number of times deactivation is retried when a deactivation error is detected
- Final Action at Deactivation: Final action when a deactivation error occurs
- Execute Script before Final Action: Whether to execute scripts when an error is detected
- Depended Resource: Dependent resource

Library Path:	Library path for controlling the virtual machine
vCenter :	vCenter host name
Resource Pool Name:	Resource pool name for starting the virtual machine
Data Store Name:	Data store name of the virtual machine
IP Address of Host:	IP Address of Host
Timeout Of Request	Wait time for the completion of the request to start or stop the virtual machine.
Timeout Of Start	Wait time for the virtual machine to start
Timeout Of Stop	Wait time for the virtual machine to stop

**When the virtual machine type is Xenserver**

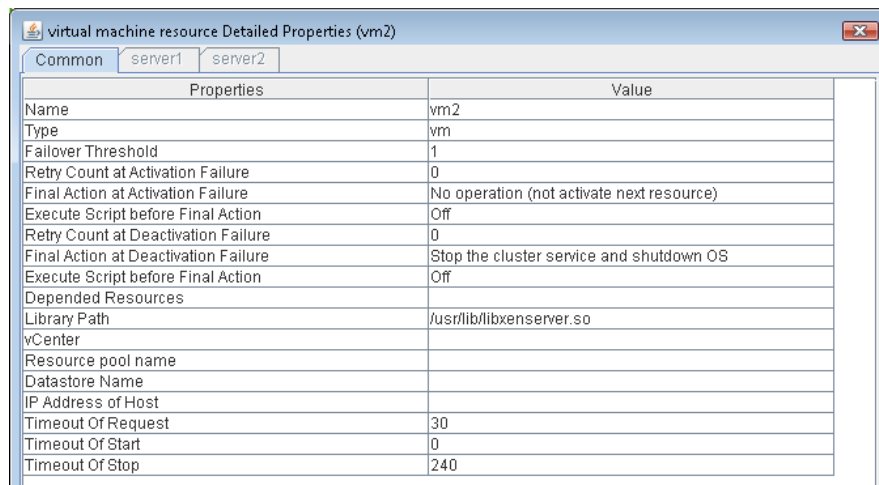

Name:	Virtual machine resource name
Type:	Resource type
Failover Threshold:	Maximum number of times failing over is performed when an activation error is detected
Retry Count at Activation Failure:	Maximum number of times activation is retried when an activation error is detected
Final Action at Activation:	Final action when an activation error occurs
Execute Script before Final Action:	Whether to execute scripts when an error is detected
Retry Count at Deactivation Failure:	Maximum number of times deactivation is retried when a deactivation error is detected
Final Action at Deactivation:	Final action when a deactivation error occurs
Execute Script before Final Action:	Whether to execute scripts when an error is detected
Depended Resource:	Dependent resource
Library Path:	Library path for controlling the virtual machine
vCenter :	vCenter host name
Resource Pool Name:	Resource pool name for starting the virtual machine
Data Store Name:	Data store name of the virtual machine
IP Address of Host:	IP Address of Host
Timeout Of Request	Wait time for the completion of the request to start or stop the virtual machine.
Management IP Address of Physical Machine	Management IP address of the physical machine
Timeout Of Start	Wait time for the virtual machine to start
Timeout Of Stop	Wait time for the virtual machine to stop

**When the virtual machine type is KVM**

Properties	Value
Name	vm3
Type	vm
Failover Threshold	1
Retry Count at Activation Failure	0
Final Action at Activation Failure	No operation (not activate next resource)
Execute Script before Final Action	Off
Retry Count at Deactivation Failure	0
Final Action at Deactivation Failure	Stop the cluster service and shutdown OS
Execute Script before Final Action	Off
Depended Resources	
Library Path	/usr/lib64/libvirt.so.0.6.3
vCenter	
Resource pool name	
Datastore Name	
IP Address of Host	
Timeout Of Request	30
Timeout Of Start	0
Timeout Of Stop	240

- |                                           |                                                                                        |
|-------------------------------------------|----------------------------------------------------------------------------------------|
| Name:                                     | Virtual machine resource name                                                          |
| Type:                                     | Resource type                                                                          |
| Failover Threshold:                       | Maximum number of times failing over is performed when an activation error is detected |
| Retry Count at Activation Failure:        | Maximum number of times activation is retried when an activation error is detected     |
| Final Action at Activation:               | Final action when an activation error occurs                                           |
| Execute Script before Final Action:       | Whether to execute scripts when an error is detected                                   |
| Retry Count at Deactivation Failure:      | Maximum number of times deactivation is retried when a deactivation error is detected  |
| Final Action at Deactivation:             | Final action when a deactivation error occurs                                          |
| Execute Script before Final Action:       | Whether to execute scripts when an error is detected                                   |
| Depended Resource:                        | Dependent resource                                                                     |
| Library Path:                             | Library path for controlling the virtual machine                                       |
| vCenter :                                 | vCenter host name                                                                      |
| Resource Pool Name:                       | Resource pool name for starting the virtual machine                                    |
| Data Store Name:                          | Data store name of the virtual machine                                                 |
| IP Address of Host:                       | IP Address of Host                                                                     |
| Timeout Of Request                        | Wait time for the completion of the request to start or stop the virtual machine.      |
| Management IP Address of Physical Machine | Management IP address of the physical machine                                          |
| Timeout Of Start                          | Wait time for the virtual machine to start                                             |
| Timeout Of Stop                           | Wait time for the virtual machine to stop                                              |

# Understanding Dynamic DNS resources

## Dependencies of Dynamic DNS resources

By default, NAS resources depend on the following group resources types:

Group resource type
---------------------

Virtual IP resource
---------------------

Floating IP resource
----------------------

AWS elastic ip resource
-------------------------

AWS virtual ip resource
-------------------------

Azure probe port resource
---------------------------

## What is a Dynamic DNS resource?

- ◆ A Dynamic DNS resource registers the virtual host name and the IP address of the active server to the Dynamic DNS server. Client applications can be connected to a cluster server by using a virtual computer name. When the virtual host name is used, the client does not have to be aware of whether the connection destination server is switched when a failover occurs or a group is moved.

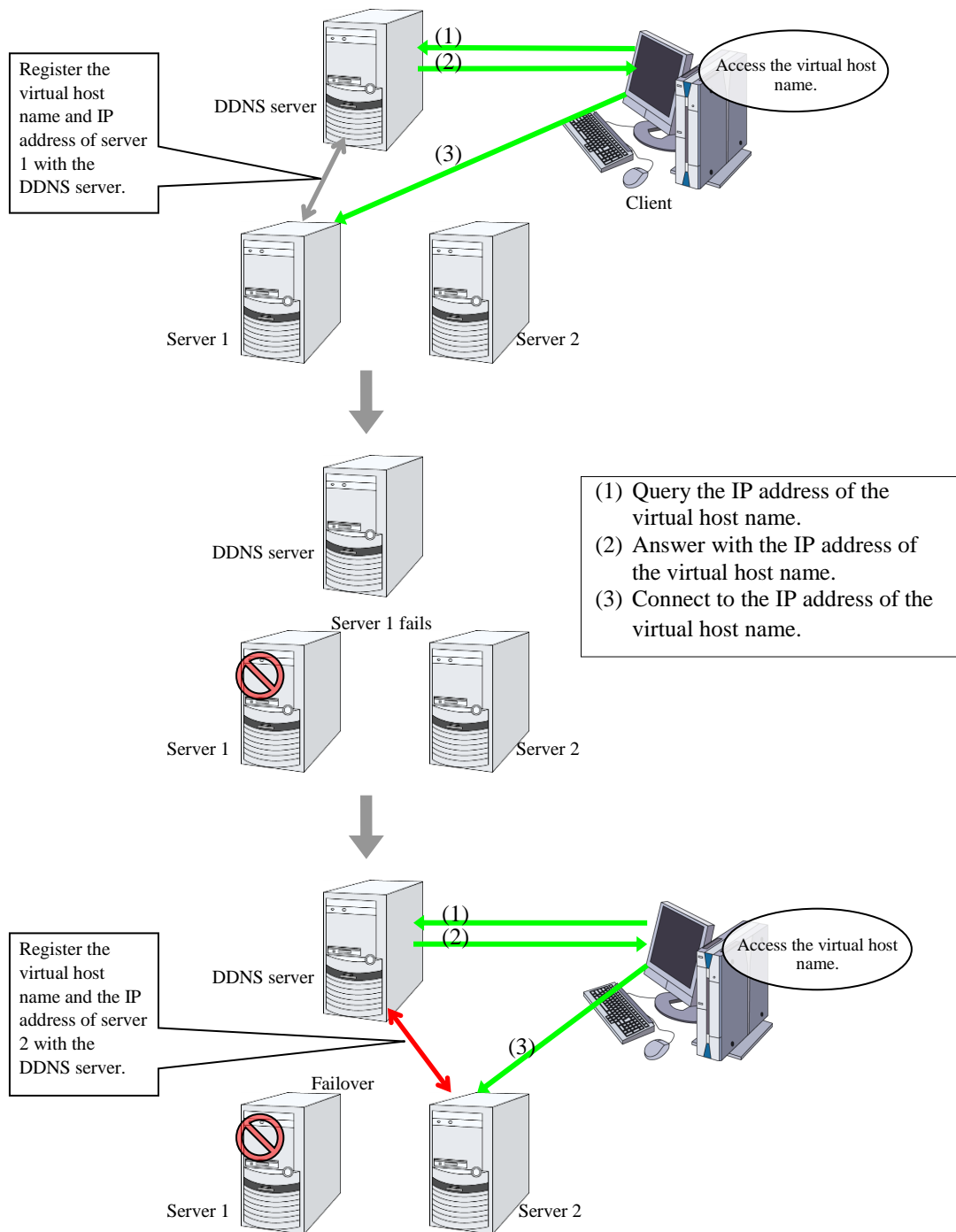



## Preparing to use Dynamic DNS resources

### Set up the DDNS server before using Dynamic DNS resources.

The description below assumes the use of BIND9.

One of the two types of `/etc/named.conf` settings below is used depending on the Dynamic DNS resource use mode when the DDNS server is set up. Specify `/etc/named.conf` on the DDNS server in the desired mode.

- ◆ When using Dynamic DNS resources with authentication

Create a shared key on the BIND9 server by using the `dnssec-keygen` command. Add the shared key to `/etc/named.conf` and allow the zone file to be updated. When adding a Dynamic DNS resource, enter the shared key name in **Authentication Key Name** and the shared key value in **Authentication Key Value**.

---

**Note:**

For details about setting up the DDNS server, using the `dnssec-keygen` command, and specifying setting other than `allow-update`, see the BIND manual.

---

Example:

1. **Generate a shared key.**

```
#dnssec-keygen -a HMAC-MD5 -b 256 -n HOST example
```

`example` is the shared key name.

When the `dnssec-keygen` command is executed, the two files below are generated. The same shared key is used for these files.

```
Kexample.+157+09088.key
Kexample.+157+09088.private
```

While the shared key is extracted from `Kexample.+157+09088.key` when using the `named.conf` setting below, using `Kexample.+157+09088.private` leads to the same result. The shared key value for `Kexample.+157+09088.key` is underlined below.

```
# cat Kexample.+157+09088.key
example. IN KEY 512 3 157 iuBgSUEIBjOUKNJ36NocAgaB
```

2. Add the shared key information to `/etc/named.conf`.

```
key " example " {
    algorithm hmac-md5;
    secret " iuBgSUEIBjOUKNJ36NocAgaB";
};
```

3. Add the shared key information to the zone statement in `/etc/named.conf`.

```
zone "example.jp" {
    :
    allow-update{
        key example;
    };
    :
};
```

4. When adding a Dynamic DNS resource by using the Builder, enter the shared key name (**example**) in **Authentication Key Name** and the shared key value (**iuBgSUEIBjOUKNJ36NocAgaB**) in **Authentication Key Value**.

- ◆ When using Dynamic DNS resources without authentication

Be sure to specify the IP addresses of all servers in the cluster as the IP address range in which the zone file can be updated (`allow-update {xxx.xxx.xxx.xxx}`) in `/etc/named.conf`.

Example:

IP address for server1 in the cluster: 192.168.10.110

IP address for server2 in the cluster: 192.168.10.111

1. Add the IP address range in which updates are allowed to the zone statement in `/etc/named.conf`.

```
zone "example.jp" {
    :
    //IP address range in which updates are allowed
    allow-update {
        192.168.10.0/24;
    };
    :
};
```

or

```
zone "example.jp" {
    :
    //IP address range in which updates are allowed
    allow-update {
        192.168.10.110;
        192.168.10.111;
    };
    :
};
```

2. When adding a Dynamic DNS resource, do not enter any values in **Authentication Key Name** or **Authentication Key Value**.

## Notes on Dynamic DNS resources

- ◆ When using Dynamic DNS resources, the `bind-utils` package is necessary on each server.
- ◆ Configuring Dynamic DNS server settings to be used is necessary to `/etc/resolve.conf` on each server.
- ◆ When IP address of each server exists in different segments, FIP address cannot be set as IP address of Dynamic DNS resources.
- ◆ To register each server IP address with the DDNS server, specify the addresses in the settings for each server.
- ◆ In case of connecting from clients using virtual host name, when the fail over of the group which has Dynamic DNS resources occurs, reconnection may be necessary (restart browsers, etc.).
- ◆ This method, which authenticates resources, applies only to a DDNS server set up using BIND9. To use the method without authentication, do not enter any values in **Authentication Key Name** or **Authentication Key Value**.
- ◆ The behavior when the WebManager is connected depends on the Dynamic DNS resource settings.
  - When the IP address of each server is specified for Dynamic DNS resources on a server basis  
If the WebManager is connected by using the virtual host name from the client, this connection is not automatically switched if a failover occurs for a group containing Dynamic DNS resources.  
To switch the connection, restart the browser, and then connect to the WebManager again.

- When the FIP address is specified for the Dynamic DNS resource  
If the WebManager is connected by using the virtual host name from the client, this connection is automatically switched if a failover occurs for a group containing Dynamic DNS resources.
- ◆ If Dynamic DNS resources are used with the method with authentication, the difference between the time of every server in the cluster and that of the DDNS server must be less than five minutes.  
If the time difference is five minutes or more, the virtual host name cannot be registered with the DDNS server.

## Displaying and changing the details of the Dynamic DNS resources

1. In the tree view displayed in the left pane of the Builder, click the icon of the group to which the Dynamic DNS resource whose details you want to display, specify, or change belongs.
2. The group resource list is displayed in the table view in the right pane of the window. Right-click the target Dynamic DNS resource name, and then click the **Details** tab in **Property**.
3. Display or change the detailed settings on the **Details** tab as described below.

### Dynamic DNS Resource Details Tab

The screenshot shows a dialog box titled "[ ddns1 ] Resource Properties" with a close button in the top right corner. The dialog has four tabs: "Info", "Dependency", "Recovery Operation", and "Details", with "Details" selected. Below the tabs are two sub-tabs: "Common" and "server1", with "server1" selected. The main area contains several text input fields with labels and values:

Virtual Host Name	virtualhost
IP Address	10.0.0.1
DDNS Server	ddnsserver
Port No.	53
Authentication Key Name	key
Authentication Key Value	value

At the bottom right of the dialog are three buttons: "OK", "Cancel", and "Apply".

#### Virtual Host Name

Enter the virtual host name to register with the DDNS service.

#### IP Address **Server Individual Setup**

Enter the IP address for the virtual host name.

When also using FIP resources, enter the IP address of the resources on the **Common** tab.

When using an IP address for each server, enter the IP address on each server tab.

**DDNS Server**

Enter the IP address of the DDNS server.

**Port No.**

Enter the port number of the DDNS server.  
The default value is 53.

**Authentication Key Name**

Enter the shared key name if a shared key was generated using the `dnssec-keygen` command.

**Authentication Key Value**

Enter the value of the shared key generated using the `dnssec-keygen` command.

**Displaying the properties of a Dynamic DNS resource by using the WebManager**

1. Start the WebManager.
2. When you click a Dynamic DNS resource object  in the tree view, the following information is displayed in the list view.

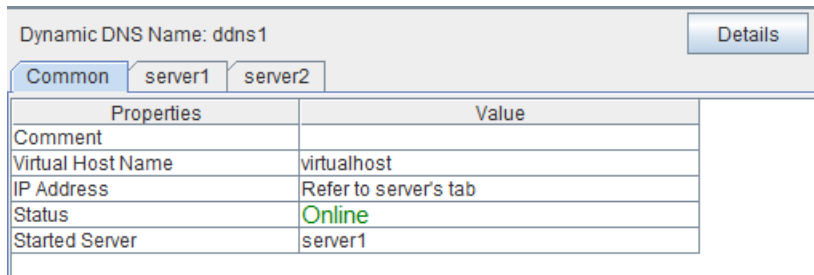

Properties	Value
Comment	
Virtual Host Name	virtualhost
IP Address	Refer to server's tab
Status	Online
Started Server	server1

Comment:	Comment on the Dynamic DNS resource
Virtual Host Name:	Virtual host name used for the Dynamic DNS resource
IP Address:	IP address used for the Dynamic DNS resource
Status:	Status of the Dynamic DNS resource
Started Server:	Name of the server

When you click **Details**, the following information is displayed.

Properties	Value
Name	ddns1
Type	ddns
Failover Threshold	1
Retry Count at Activation Failure	1
Final Action at Activation Failure	No operation (not activate next resource)
Execute Script before Final Action	Off
Retry Count at Deactivation Failure	1
Final Action at Deactivation Failure	Stop the cluster daemon and shutdown OS
Execute Script before Final Action	Off
Depended Resources	fip1,vip1
DNS Server	ddnsserver
Port Number	53

Name:	Dynamic DNS resource name
Type:	Resource type
Failover Threshold:	Maximum number of times failing over is performed when an activation error is detected
Retry Count at Activation Failure:	Maximum number of times activation is retried when an activation error is detected
Final Action at Activation Failure:	Final action when an activation error occurs
Execute Script before Final Action:	Whether to execute scripts when an error is detected
Retry Count at Deactivation Failure:	Maximum number of times deactivation is retried when a deactivation error is detected
Final Action at Deactivation:	Final action when a deactivation error occurs
Execute Script before Final Action:	Whether to execute scripts when an error is detected
Depended Resource:	Dependent resource
DDNS Server:	IP address of the DDNS server
Port Number:	Port number of the DDNS server

## Understanding AWS elastic ip resources

### Dependencies of AWS elastic ip resources

By default, this function does not depend on any group resource type.

### What is an AWS elastic ip resource?

Client applications can use AWS Elastic IP addresses (referred to as the EIP) to access the Amazon Virtual Private Cloud (referred to as the VPC) in the Amazon Web Services (referred to as AWS) environment.

By using EIP, clients do not need to be aware of switching access destination server when a failover occurs or moving a group migration.

#### HA cluster with EIP control

This is used to place instances on private subnets (release business operations inside the VPC).

A configuration such as the following is assumed: Instances to be clustered are placed on public subnets in each Availability Zone (referred to as AZ), and each instance can access the Internet via the gateway.

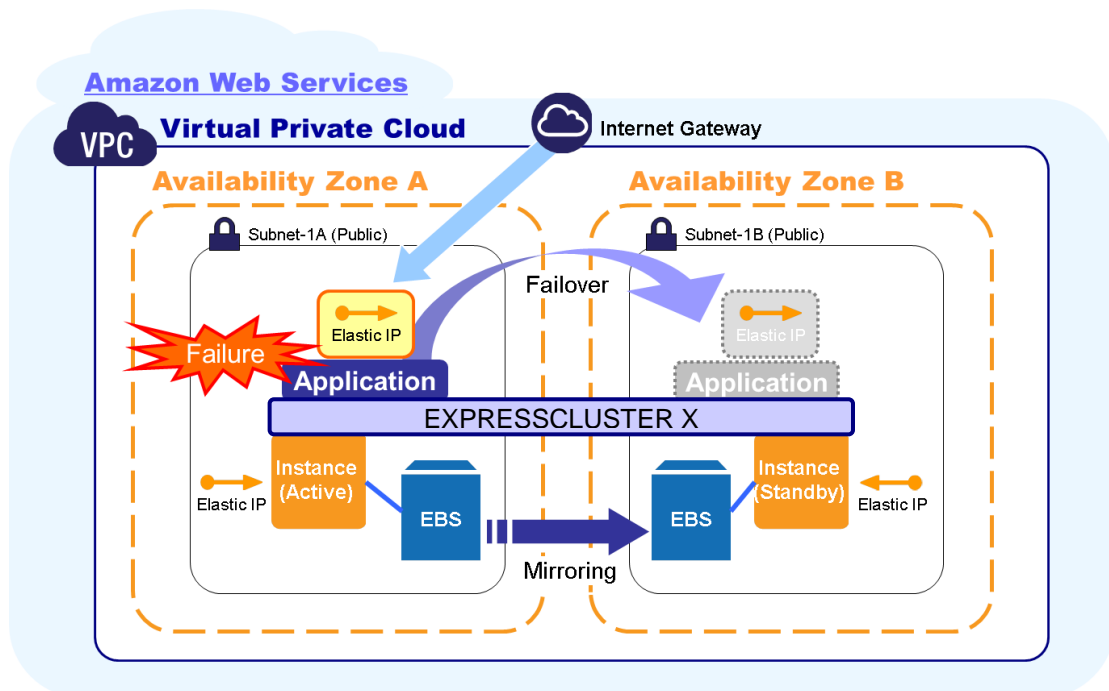

### Notes on AWS elastic ip resources

- ◆ See "Setting up AWS elastic ip resources" in "Notes when creating EXPRESSCLUSTER configuration data" in Chapter 5, "Notes and Restrictions" in the *Getting Started Guide*.

### Applying environment variables to AWS CLI run from the AWS elastic ip resource

Specify environment variables in the environment variable configuration file to apply environment variables to the AWS CLI run from the AWS elastic ip resource, AWS virtual ip resource, AWS elastic ip monitor resource and AWS AZ monitor resource.

This feature is useful when using a proxy server in an AWS environment.

The environment variable configuration file is stored in the following location.

<EXPRESSCLUSTER Installation path>/cloud/aws/clpaws\_setting.conf

The format of the environment variable configuration file is as follows:

Environment variable name = Value

(Example)

[ENVIRONMENT]

HTTP\_PROXY = http://10.0.0.1:3128

HTTPS\_PROXY = http://10.0.0.1:3128

The specifications of the environment variable configuration file are as follows:

- ◆ Write [ENVIRONMENT] on the first line. If this is not set, the environment variables will not be set.
- ◆ If the environment variable configuration file does not exist or you do not have read permission for the file, the variables are ignored. This does not cause an activation failure or a monitor error.
- ◆ If the same environment variables already exist in the file, the values are overwritten.
- ◆ More than one environment variable can be set. Set one environment variable on each line.
- ◆ The settings are valid regardless of whether there are spaces before and after “=” or not.
- ◆ The settings are invalid if there is a space or tab in front of the environment variable name or if there are tabs before and after “=”.
- ◆ Environment variable names are case sensitive.
- ◆ Even if a value contains spaces, you do not have to enclose the value in “” (double quotation marks).

## Displaying and changing the AWS elastic ip resource details

1. In the tree view in the left pane of the Builder, click the icon of the group to which the AWS elastic ip resource whose detailed information you can to display and change belongs.
2. A list of group resources is shown on the table view in the right pane of the screen. Right-click the target AWS elastic ip resource name and then click the **Details** tab of **Properties**
3. Display and/or change the detailed settings on the Details tab as described below.

### AWS elastic ip resource: Details tab

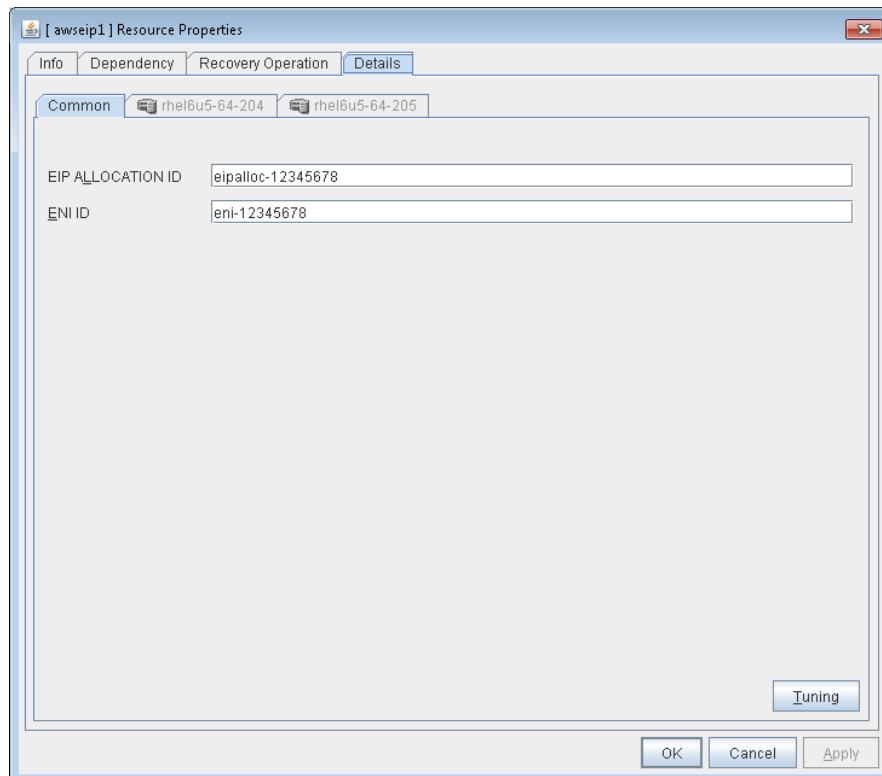

**EIP ALLOCATION ID** (Within 45 bytes)  
For EIP control, specify the ID of the EIP to replace.

**ENI ID** (Within 45 bytes) **Server Individual Setup**  
For EIP control, specify the ENI ID to which to allocate an EIP. In the **Common** tab, describes the ENI ID of any server, other servers, please to perform the individual setting.

### Tuning AWS elastic ip resource

1. In the tree view shown on the left pane of the Builder, click the icon of the group to which the AWS elastic ip resource whose detailed information you want to display and change belongs.
2. The group resource list is shown on the table view in the right pane of the screen. Right-click the desired AWS elastic ip resource name. Then click **Properties** and select the **Details** tab.
3. Click **Tuning** on the **Details** tab. The AWS elastic ip resource Tuning Properties dialog box is displayed.
4. On the **Details** tab, you can see and/or change the settings of monitor resource by following the description below.



### Parameter tab

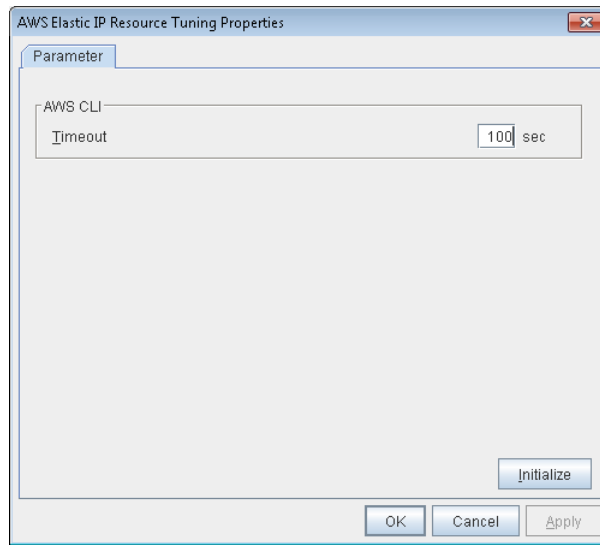

**Timeout** (1 to 999)

Set the timeout of the AWS CLI command to be executed for AWS elastic ip resource activation/deactivation.

## Displaying the AWS elastic ip resource properties with the WebManager

1. Start the WebManager.
2. When you click an object for the AWS elastic ip resources  in the tree view, the following information is displayed in the list view.

AWS Elastic IP: awseip1		Details	
Common		server1	server2
Properties	Value		
Comment			
EIP ALLOCATION ID	eipalloc-12345678		
ENI ID	eni-12345678		
Status	Offline		
Started Server			

Comment: Comment for the AWS elastic ip resource  
 EIP ALLOCATION ID: EIP ALLOCATION ID  
 ENI ID: ENI ID  
 Status: Status of the AWS elastic ip resource  
 Started Server: Server name

When you click **Details**, the following information is displayed in the pop-up dialog box:

Properties	Value
Name	awseip1
Type	awseip
Failover Threshold	1
Retry Count at Activation Failure	5
Final Action at Activation Failure	No operation (not activate next resource)
Execute Script before Final Action	Off
Retry Count at Deactivation Failure	0
Final Action at Deactivation Failure	Stop the cluster service and shutdown OS
Execute Script before Final Action	Off
Depended Resources	
AWS CLI Timeout (sec)	100

<b>Name:</b>	AWS elastic ip resource name
<b>Type:</b>	Resource type
<b>Failover Threshold:</b>	Failover count at activation failures
<b>Retry Count at Activation Failure:</b>	Activation retry count at activation failures
<b>Final Action at Activation Failure:</b>	Final action at activation failures
<b>Execute Script before Final Action:</b>	Whether or not a script is executed upon activation failure
<b>Retry Count at Deactivation Failure:</b>	Deactivation retry countat deactivation failures
<b>Final Action at Deactivation Failure:</b>	Final action at deactivation failures
<b>Execute Script before Final Action:</b>	Whether or not a script is executed upon deactivation failure
<b>Dependent Resources:</b>	Dependent resources
<b>AWS CLI Timeout (sec)</b>	AWS CLI timeout

# Understanding AWS virtual ip resources

## Dependencies of AWS virtual ip resources

By default, this function does not depend on any group resource type.

## What is an AWS virtual ip resource?

Client applications can use AWS virtual ip addresses(referred to as the VIP) to access the VPC in AWS environment.

By using VIP, clients do not need to be aware of switching access destination server when a failover occurs or moving a group migration.

AWS CLI command is executed for AWS virtual ip resource when it is activated to update the route table information.

### **HA cluster with VIP control**

This is used to place instances on private subnets (release business operations inside the VPC).

A configuration such as the following is assumed: Instances to be clustered, as well as the instance group accessing the instances, are placed on private subnets in each Availability Zone (referred to as AZ), and each instance can access the Internet via the NAT instance placed on the public subnet.



## Notes on AWS virtual ip resources

- ◆ See "Setting up AWS virtual ip resources" in "Notes when creating EXPRESSCLUSTER configuration data" in Chapter 5, "Notes and Restrictions" in the *Getting Started Guide*.

## Applying environment variables to AWS CLI run from the AWS virtual ip resource

Specify environment variables in the environment variable configuration file to apply environment variables to the AWS CLI run from the AWS elastic ip resource, AWS virtual ip resource, AWS elastic ip monitor resource and AWS AZ monitor resource.

This feature is useful when using a proxy server in an AWS environment.

The environment variable configuration file is stored in the following location.

<EXPRESSCLUSTER Installation path>/cloud/aws/clpaws\_setting.conf

The format of the environment variable configuration file is as follows:

Environment variable name = Value

(Example)

```
[ENVIRONMENT]
```

```
HTTP_PROXY = http://10.0.0.1:3128
```

```
HTTPS_PROXY = http://10.0.0.1:3128
```

The specifications of the environment variable configuration file are as follows:

- ◆ Write [ENVIRONMENT] on the first line. If this is not set, the environment variables will not be set.
- ◆ If the environment variable configuration file does not exist or you do not have read permission for the file, the variables are ignored. This does not cause an activation failure or a monitor error.
- ◆ If the same environment variables already exist in the file, the values are overwritten.
- ◆ More than one environment variable can be set. Set one environment variable on each line.
- ◆ The settings are valid regardless of whether there are spaces before and after “=” or not.
- ◆ The settings are invalid if there is a space or tab in front of the environment variable name or if there are tabs before and after “=”.
- ◆ Environment variable names are case sensitive.
- ◆ Even if a value contains spaces, you do not have to enclose the value in “” (double quotation marks).

## Displaying and changing the AWS virtual ip resource details

1. In the tree view in the left pane of the Builder, click the icon of the group to which the AWS virtual ip resource whose detailed information you can to display and change belongs.
2. A list of group resources is shown on the table view in the right pane of the screen. Right-click the target AWS virtual ip resource name and then click the **Details** tab of **Properties**.
3. Display and/or change the detailed settings on the **Details** tab as described below.

### AWS virtual ip resource: Details tab

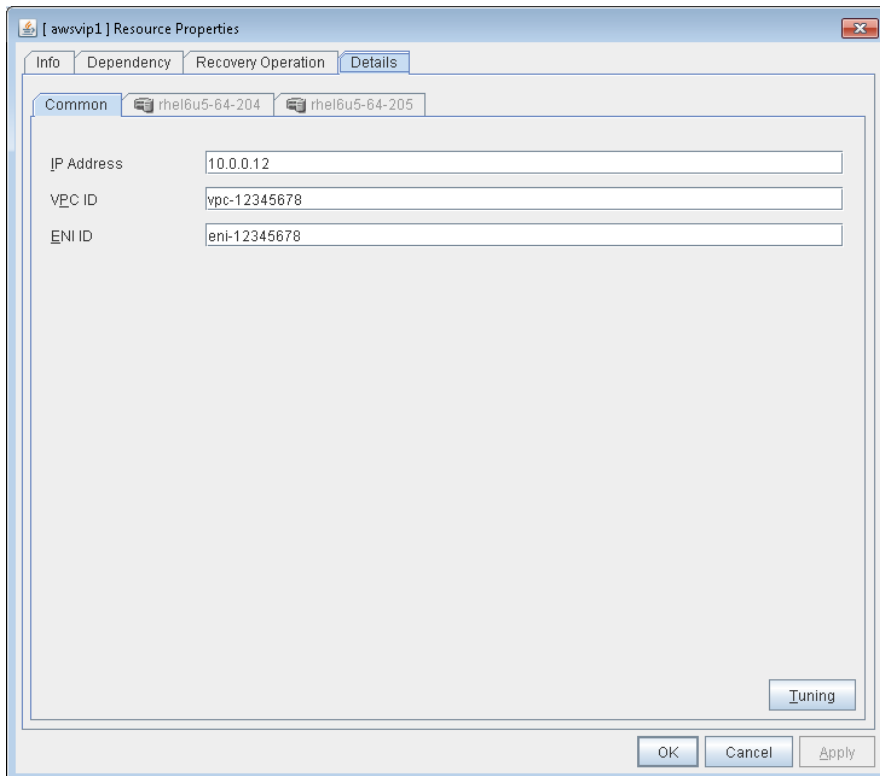

#### IP Address (Within 45 bytes)

For VIP control, specify the VIP address to use. As the VIP address, an IP address not belonging to a subnet in the VPC must be specified.

#### VPC ID (Within 45 bytes) **Server Individual Setup**

For VIP control, specify the VPC ID to which the server belongs. To specify an individual VPC ID for the servers, enter the VPC ID of any server on the Common tab and specify a VPC ID for the other servers individually. For how to set routing, see "AWS elastic ip resources, AWS virtual ip resources, AWS elastic ip monitor resources, AWS virtual ip monitor resources, and AWS AZ monitor resources" in Chapter 8, "Information on other setting".

#### ENI ID (Within 45 bytes) **Server Individual Setup**

For VIP control, specify the ENI ID of VIP routing destination. For the ENI ID to specify, Source/Dest. Check must be disabled beforehand. This must be set for each server. On the Common tab, enter the ENI ID of any server, and specify an ENI ID for the other servers individually.

## Tuning AWS virtual ip resources

1. In the tree view shown on the left pane of the Builder, click the icon of the group to which the AWS virtual ip resource whose detailed information you want to display and change belongs.
2. The group resource list is shown on the table view in the right pane of the screen. Right-click the desired AWS virtual ip resource name. Then click Properties and select the Details tab.
3. Click Tuning on the Details tab. The AWS virtual ip Resource Tuning Properties dialog box is displayed.
4. On the Details tab, you can see and/or change the settings of monitor resource by following the description below.

### Parameter tab

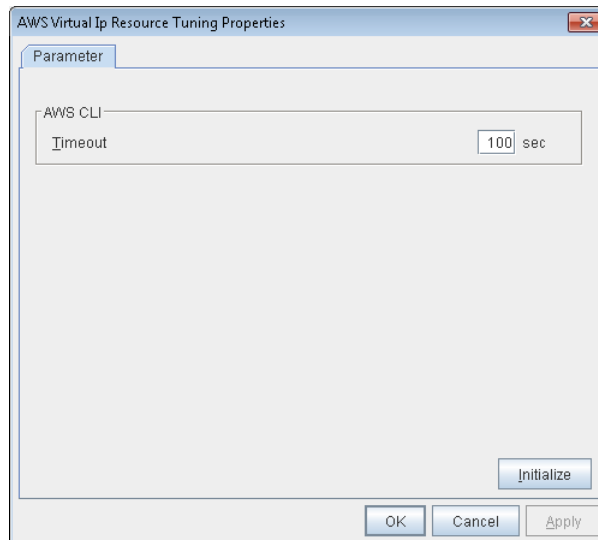

**Timeout** (1 to 999)

Set the timeout of the AWS CLI command to be executed for AWS virtual ip resource activation/deactivation.

## Displaying the AWS virtual ip resource properties with the WebManager

1. Start the WebManager.
2. When you click an object for the AWS virtual ip resources  in the tree view, the following information is displayed in the list view.

AWS Virtual IP: awsvip1		Details	
Common		server1	server2
Properties	Value		
Comment			
IP Address	10.0.0.12		
VPC ID	vpc-12345678		
ENI ID	eni-12345678		
Status	Offline		
Started Server			

Comment: Comment for the AWS virtual ip resource  
 IP Address: IP address  
 VPC ID: VPC ID  
 ENI ID: ENI ID  
 Status: Status of the AWS virtual ip resource  
 Started Server: Server name

When you click **Details**, the following information is displayed in the pop-up dialog box:

Properties	Value
Name	awsvip1
Type	awsvip
Failover Threshold	1
Retry Count at Activation Failure	5
Final Action at Activation Failure	No operation (not activate next resource)
Execute Script before Final Action	Off
Retry Count at Deactivation Failure	0
Final Action at Deactivation Failure	Stop the cluster service and shutdown OS
Execute Script before Final Action	Off
Depended Resources	
AWS CLI Timeout (sec)	100

Name:	AWS virtual ip resource name
Type:	Resource type
Failover Threshold:	Failover count at activation failures
Retry Count at Activation Failure:	Activation retry count at activation failures
Final Action at Activation Failure:	Final action at activation failures
Execute Script before Final Action:	Whether or not a script is executed upon activation failure
Retry Count at Deactivation Failure:	Deactivation retry countat deactivation failures
Final Action at Deactivation Failure:	Final action at deactivation failures
Execute Script before Final Action:	Whether or not a script is executed upon deactivation failure
Dependent Resources:	Dependent resources
AWS CLI Timeout (sec)	AWS CLI timeout



# Understanding Azure probe port resources

## Dependencies of Azure probe port resources

By default, this function does not depend on any group resource type.

## What is an Azure probe port resource?

Client applications can use the global IP address called a public virtual IP (VIP) address (referred to as a VIP in the remainder of this document) to access virtual machines on an availability set in the Microsoft Azure environment.

By using VIP, clients do not need to be aware of switching access destination server when a failover occurs or moving a group migration.

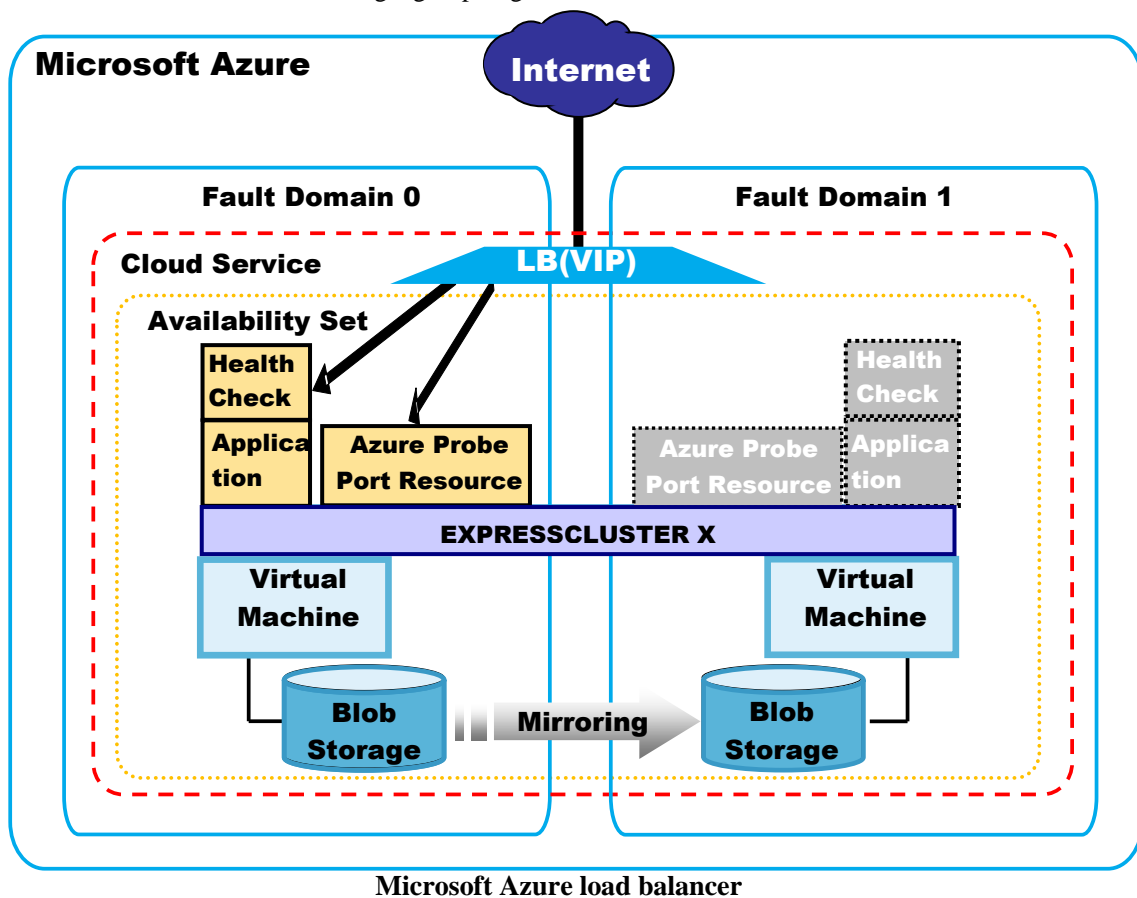

To access the cluster created on the Microsoft Azure environment in the figure above, specify the end point for communicating from the outside with VIP or the end point for communicating from the outside with the DNS name. The active and standby nodes of the cluster are switched by controlling the Microsoft Azure load balancer (LB in the figure above) from EXPRESSCLUSTER. For control, Health Check in the figure above is used.

At activation, start the probe port control process for waiting for alive monitoring (access to the probe port) from the Azure load balancer.

At deactivation, stop the probe port control process for waiting for alive monitoring (access to the probe port).

Azure probe port resources also support the Internal Load Balancing of Microsoft Azure. For Internal Load Balancing, the VIP is the private IP address of Azure.

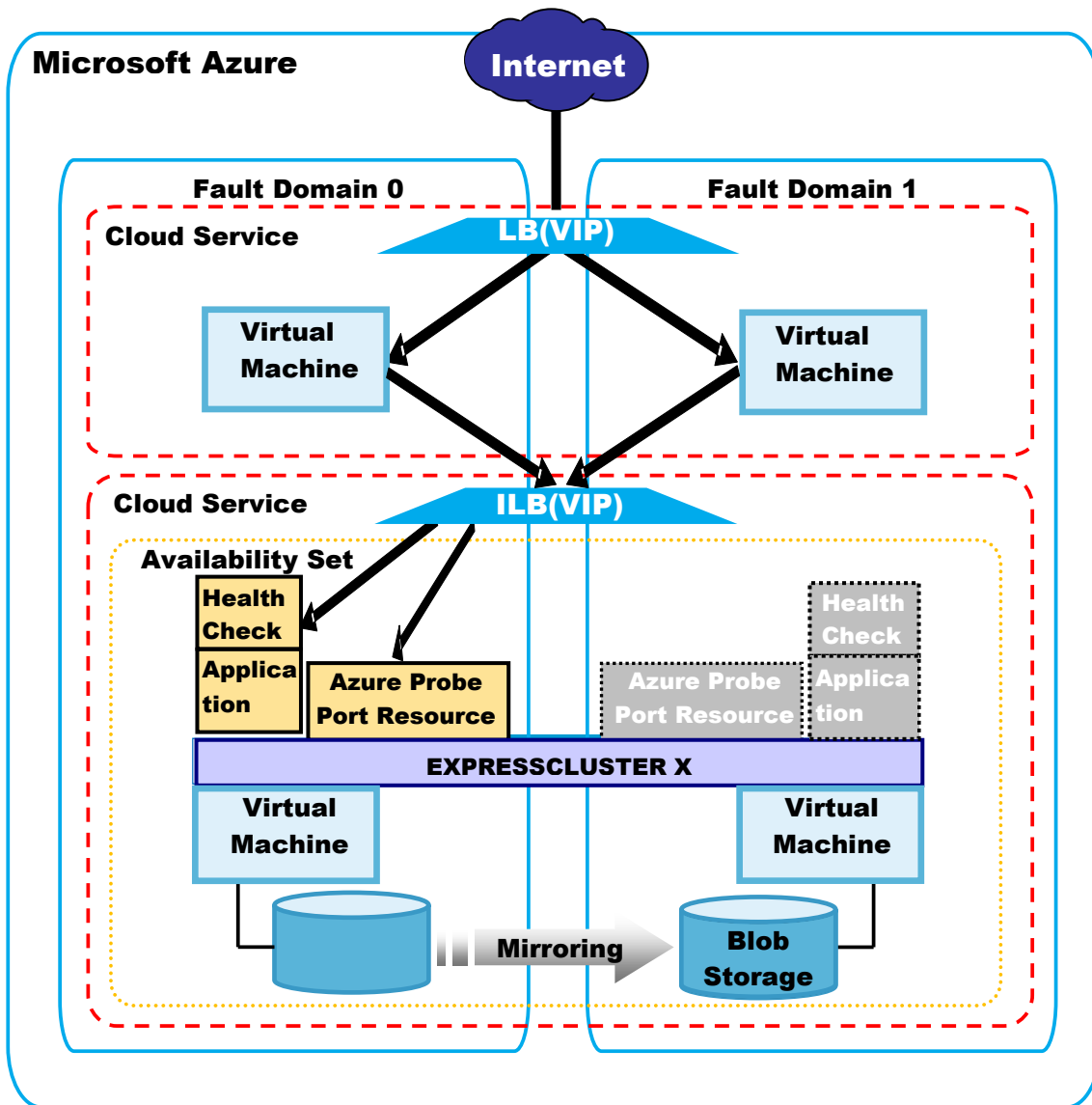

Internal Load Balancing of Microsoft Azure

## Notes on Azure probe port resources

- ◆ If the private port and the probe port are the same, you need not add Azure probe port resources or Azure probe port monitor resources.
- ◆ Refer to “Azure probe port resource settings” on “Notes when creating EXPRESSCLUSTER configuration data” in Chapter 5 “Notes and Restrictions” of the *Getting Started Guide*.

## Displaying and changing the details of Azure probe port resources

1. In the tree view shown on the left pane of the Builder, click the icon of the group to which the Azure probe port resource whose detailed information you want to display and change belongs.

2. A group resource list is shown in the table view on the right side of the screen. Right-click the desired Azure probe port resource name. Then click **Properties** and select the **Details** tab.
3. On the **Details** tab, you can display and/or change the settings by following the description below.

### Azure probe port Resource Properties: Details tab

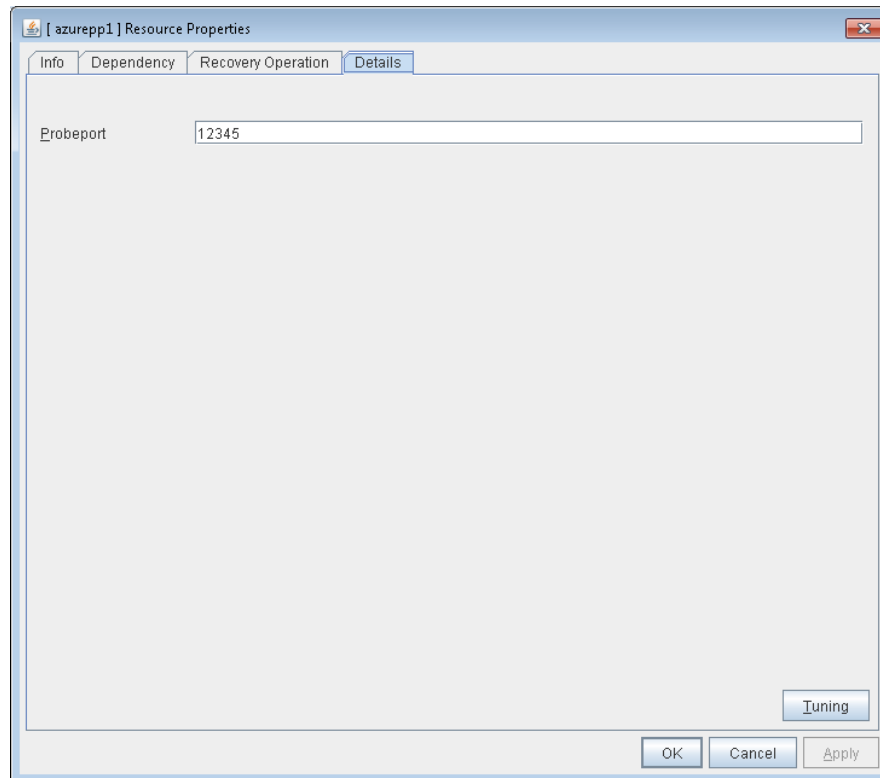

#### **Probe port (1 to 65535)**

Specify the port number used by the Azure load balancer for the alive monitoring of each server. Specify the value specified for Probe Port when creating an end point. For Probe Protocol, specify TCP.

#### **Tuning**

Display the **Azure probe port Resource Tuning Properties** dialog box. Specify detailed settings for the Azure probe port resources.

## Tuning Azure probe port resource

1. In the tree view shown on the left pane of the Builder, click the icon of the group to which the Azure probe port resource whose detailed information you want to display and change belongs.
2. The list of group resources is shown in the table view on the right side of the screen. Right-click the desired Azure probe port resource name. Then click **Properties** and select the **Details** tab.
3. Click **Tuning** on the **Details** tab. The **Azure probe port Resource Tuning Properties** dialog box is displayed.
4. On the **Details** tab, you can display and/or change the settings by following the description below.

### Parameter tab

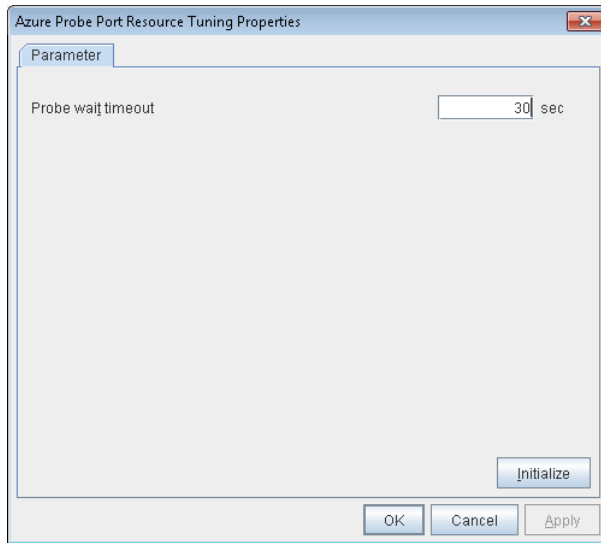

**Probe wait timeout** (5 to 999999999)

Specify the timeout time for waiting alive monitoring from the Azure load balancer. Check if alive monitoring is performed periodically from the Azure load balancer.

## Displaying the Azure probe port resource properties with the WebManager

1. Start the WebManager.
2. When you click an Azure probe port resource object  in the tree view, the following information is displayed in the list view.

Azure probe port: azurepp1		Details
Common server1 server2		
Properties	Value	
Comment		
Probe Port	12345	
Status	Offline	
Started Server		

Comment: Azure probe port resource comment  
 Status: Status of the Azure probe port resource  
 Started Server: Server name  
 Probe Port: Port number used for the alive monitoring of each server

When you click **Details**, the following information is displayed in the pop-up dialog box:

Properties	Value
Name	azurepp1
Type	azurepp
Failover Threshold	1
Retry Count at Activation Failure	5
Final Action at Activation Failure	No operation (not activate next resource)
Execute Script before Final Action	Off
Retry Count at Deactivation Failure	0
Final Action at Deactivation Failure	Stop the cluster service and shutdown OS
Execute Script before Final Action	Off
Depended Resources	
Probe Timeout (sec)	30

Name:	Azure probe port resource name
Type:	Resource type
Failover Threshold:	The number of failovers to be made at detection of an error
Retry Count at Activation Failure:	The number of times activation is retried when an activation error is detected
Final Action at Activation Failure:	Final action at an activation error
Execute Script before Final Action:	Whether or not script is executed upon deactivation failure
Retry Count at Deactivation Failure:	The number of times deactivation is retried when a deactivation error is detected
Final Action at Deactivation Failure:	Final action when a deactivation error is detected
Execute Script before Final Action:	Whether or not script is executed upon deactivation failure
Dependent Resources:	Dependent resources
Probe Timeout (sec):	Timeout time for waiting alive monitoring



# Chapter 5 Monitor resource details

This chapter provides detailed information on monitor resources. Monitor resource is a unit to perform monitoring.

This chapter covers:

- Monitor resource..... 821
- Understanding the disk monitor resources..... 889
- Understanding IP monitor resources ..... 900
- Understanding floating IP monitor resources ..... 905
- Understanding NIC Link Up/Down monitor resources ..... 910
- Understanding mirror disk connect monitor resources..... 917
- Understanding mirror disk monitor resources..... 922
- Understanding hybrid disk connect monitor resources ..... 926
- Understanding hybrid disk monitor resources ..... 931
- Understanding PID monitor resources ..... 936
- Understanding user-mode monitor resources ..... 940
- Understanding multi target monitor resources ..... 953
- Understanding virtual IP monitor resources..... 960
- Understanding ARP monitor resources ..... 964
- Understanding custom monitor resources ..... 969
- Understanding volume manager monitor resources ..... 977
- Understanding message receive monitor resources ..... 982
- Understanding VM monitor resources ..... 992
- Understanding Dynamic DNS monitor resources ..... 996
- Understanding process name monitor resources..... 999
- Understanding BMC monitor resources ..... 1005
- Understanding DB2 monitor resources ..... 1006
- Understanding FTP monitor resources..... 1013
- Understanding HTTP monitor resources ..... 1018
- Understanding IMAP4 monitor resources ..... 1023
- Understanding MySQL monitor resources ..... 1028
- Understanding NFS monitor resources ..... 1035
- Understanding Oracle monitor resources..... 1041
- Understanding OracleAS monitor resources ..... 1051
- Understanding Oracle Clusterware Synchronization Management monitor resources ..... 1057
- Understanding POP3 monitor resources ..... 1058
- Understanding PostgreSQL monitor resource ..... 1063
- Understanding Samba monitor resources..... 1070
- Understanding SMTP monitor resources ..... 1075
- Understanding Sybase monitor resources ..... 1080
- Understanding Tuxedo monitor resource ..... 1087
- Understanding Weblogic monitor resources ..... 1092
- Understanding Websphere monitor resources ..... 1098
- Understanding WebOTX monitor resources ..... 1104
- Understanding JVM monitor resources ..... 1111

- Understanding system monitor resources..... 1167
- Understanding AWS elastic ip monitor resources ..... 1184
- Understanding AWS virtual ip monitor resources..... 1188
- Understanding AWS AZ monitor resources..... 1192
- Understanding Azure probe port monitor resources..... 1196
- Understanding Azure load balance monitor resources ..... 1200



## Monitor resource

A monitor resource refers to a resource that monitors a specified target to be monitored. When detecting an error in a target to be monitored, a monitor resource restarts a group resource and/or executes failover.

Currently supported monitor resources:

Monitor resource name	Abbreviation	Functional overview	Supported version
Disk Monitor Resource	diskw	See "Understanding the disk monitor resources" on page 889.	3.0.0-1 or later
IP Monitor Resource	ipw	See "Understanding IP monitor resources" on page 900.	3.0.0-1 or later
Floating IP monitor resource	fipw	See "Understanding floating IP monitor resources" on page 905.	3.0.0-1 or later
NIC Link Up/Down Monitor Resource	miiw	See "Understanding NIC Link Up/Down monitor resources" on page 910.	3.0.0-1 or later
Mirror Disk Connect Monitor Resource	mdnw	See "Understanding mirror disk connect monitor resources" on page 917.	3.0.0-1 or later
Mirror Disk Monitor Resource	mdw	See "Understanding mirror disk monitor resources" on page 922.	3.0.0-1 or later
Hybrid Disk Connect Monitor Resource	hdnw	See "Understanding hybrid disk connect monitor resources" on page 926.	3.0.0-1 or later
Hybrid Disk Monitor Resource	hdw	See "Understanding hybrid disk monitor resources" on page 931.	3.0.0-1 or later
PID Monitor Resource	pidw	See "Understanding PID monitor resource" on page 936.	3.0.0-1 or later
User-Mode Monitor Resource	userw	See "Understanding user-mode monitor resource" on page 940.	3.0.0-1 or later
Multi Target Monitor Resource	mtw	See "Understanding multi target monitor resource on page 953.	3.0.0-1 or later
Virtual IP Monitor Resource	vipw	See "Understanding virtual IP monitor resources on page 964.	3.0.0-1 or later
ARP Monitor Resource	arpw	See "Understanding ARP monitor resources" on page 964.	3.0.0-1 or later
Custom monitor Resource	genw	See "Understanding custom monitor resources" on page 969.	3.0.0-1 or later
Volume Manager Monitor Resource	volmgrw	See "Understanding volume manager monitor resources" on page 977.	3.0.0-1 or later
Message Receive Monitor Resource	mrw	See "Understanding message receive monitor resources" on page 982.	3.0.0-1 or later
VM Monitor Resource	vmw	See "Understanding VM monitor resources." on page 992.	3.0.0-1 or later
Dynamic DNS Monitor Resource	ddns	See "Understanding Dynamic DNS monitor resources" on page 996.	3.0.0-1 or later
Process Name Monitor Resource	psw	See "Understanding process name monitor resources" on page 999.	3.0.0-1 or later

Monitor resource name	Abbreviation	Functional overview	Supported version
BMC Monitor Resource	bmcw	See “Understanding BMC monitor resources” on page 1005.	3.2.0-1 or later
DB2 Monitor Resource <sup>1</sup>	db2w	See “Understanding DB2 monitor resources” on page 1006.	3.0.0-1 or later
FTP Monitor Resource <sup>1</sup>	ftpw	See “Understanding FTP monitor resources” on page 1013.	3.0.0-1 or later
HTTP Monitor Resource <sup>1</sup>	httpw	See “Understanding HTTP monitor resources on page 1018.	3.0.0-1 or later
IMAP4 Monitor Resource <sup>1</sup>	imap4w	See “Understanding IMAP4 monitor resources” on page 1023.	3.0.0-1 or later
MySQL Monitor Resource <sup>1</sup>	mysqlw	See “Understanding MySQL monitor resources” on page 1028.	3.0.0-1 or later
NFS Monitor Resource <sup>1</sup>	nfsw	See “Understanding NFS monitor resources” on page 1035.	3.0.0-1 or later
Oracle Monitor Resource <sup>1</sup>	oraclew	See “Understanding Oracle monitor resources” on page 1041.	3.0.0-1 or later
OracleAS Monitor Resource <sup>1</sup>	oracleasw	See “Understanding OracleAS monitor resources” on page 1051.	3.0.0-1 or later
Oracle Clusterware Synchronization Management Monitor Resource	osmw	See “Understanding Oracle Clusterware Synchronization Management monitor resources” on page 1057.	3.2.0-1 or later
POP3 Monitor Resource <sup>1</sup>	pop3w	See “Understanding POP3 monitor resources “ on page 1058.	3.0.0-1 or later
PostgreSQL Monitor Resource <sup>1</sup>	psqlw	See “Understanding PostgreSQL monitor resource on page 1063.	3.0.0-1 or later
Samba Monitor Resource <sup>1</sup>	sambaw	See “Understanding Samba monitor resources on page 1070.	3.0.0-1 or later
SMTP Monitor Resource <sup>1</sup>	smtpw	See “Understanding SMTP monitor resources on page 1075.	3.0.0-1 or later
Sybase Monitor Resource <sup>1</sup>	sybasew	See “Understanding Sybase monitor resource on page 1080.	3.0.0-1 or later
Tuxedo Monitor Resource <sup>1</sup>	tuxw	See “Understanding Tuxedo monitor resource on page 1087.	3.0.0-1 or later
Weblogic Monitor Resource <sup>1</sup>	wlsw	See “Understanding Weblogic monitor resources on page 1092.	3.0.0-1 or later
Websphere Monitor Resource <sup>1</sup>	wasw	See “Understanding Websphere monitor resources on page 1098.	3.0.0-1 or later
WebOTX Monitor Resource <sup>1</sup>	otxw	See “Understanding WebOTX monitor resources” on page 1104.	3.0.0-1 or later
JVM Monitor Resource	jraw	See “Understanding JVM monitor resources” on page 1111.	3.1.0-1 or later
System Monitor Resource	sraw	See “Understanding system monitor resources” on page 1167.	3.1.0-1 or later

<sup>1</sup> To use this monitor resource, you need to register a license. For details on how to register a license, see the *Installation and Configuration Guide*.

Monitor resource name	Abbreviation	Functional overview	Supported version
AWS elastic ip monitor resource	awseipw	See “Understanding AWS elastic ip monitor resources” on page 1184.	3.3.0-1 or later
AWS virtual ip monitor resource	awsvipw	See “Understanding AWS virtual ip monitor resources” on page1188.	3.3.0-1 or later
AWS AZ monitor resource	awsazw	See “Understanding AWS AZ monitor resources” on page1192.	3.3.0-1 or later
Azure probe port monitor resource	azureppw	See “Understanding Azure probe port monitor resources” on page1196.	3.3.0-1 or later
Azure load balance monitor resource	azurelbw	See “Understanding Azure load balance monitor resources” on page1200.	3.3.0-1 or later

## Status of monitor resources after monitoring starts

The status of some monitor resources might be “Caution” if there is a period of time following the start of monitoring in which monitoring of that resource is not yet ready.

Caution status is possible for the following monitor resources.

- Dynamic DNS Monitor Resource
- Message Receive Monitor Resource
- Custom Monitor Resource (whose monitor type is **Asynchronous**)
- Virtual IP Monitor Resource
- DB2 Monitor Resource
- BMC Monitor Resource
- System Monitor Resource
- JVM Monitor Resource
- MySQL Monitor Resource
- Oracle Monitor Resource
- Oracle Clusterware Synchronization Management Monitor Resource
- PostgreSQL Monitor Resource
- Process Name Monitor Resource
- Sybase Monitor Resource

## Monitor timing of monitor resource

There are two types of monitoring by monitor resources; **Always** and **Active**.

The monitoring timing differs depending on monitor resources:

- ◆ **Always:**  
Monitoring is performed by monitor resource all the time.
- ◆ **Active:**  
Monitoring is performed by monitor resource while specified group resource is active.  
Monitor resource does not monitor while group resource is not activated.

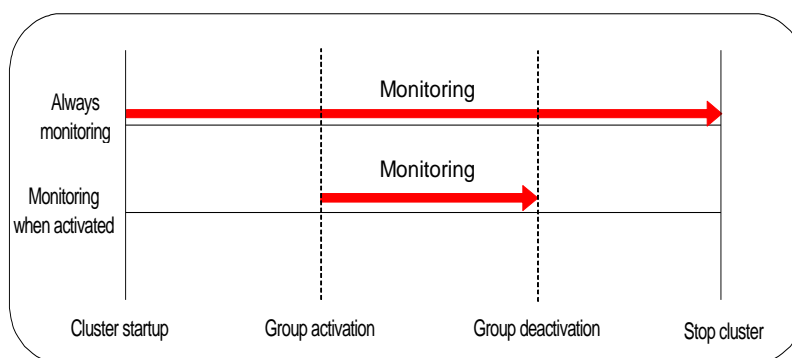

Monitor resource	Monitor timing	Target resource
Disk Monitor Resource	Always or when activated	All
IP Monitor Resource	Always or when activated	All
User-Mode Monitor Resource	Always (Fixed)	-
Mirror Disk Monitor Resource	Always (Fixed)	-
Mirror Disk Connect Monitor Resource	Always (Fixed)	-
Hybrid Disk Monitor Resource	Always (Fixed)	-
Hybrid Disk Connect Monitor Resource	Always (Fixed)	-
NIC Link Up/Down Monitor resource	Always or when activated	All
PID Monitor resource	Fixed to while activating	exec
Multi Target Monitor Resource	Always or when activated	All
Virtual IP Monitor Resource	When activated (Fixed)	vip
ARP Monitor Resource	When activated (Fixed)	fip, vip
Custom Monitor resource	Always or when activated	All
VM Monitor Resource	Always (Fixed)	vm
Message Receive Monitor Resource	Always or when activated	mrw
Volume Manager Monitor Resource	Always or when activated	volmgr
Dynamic DNS Monitor Resource	Always (Fixed)	ddns
Process Name Monitor Resource	Always or when activated	All
BMC Monitor Resource	Always (Fixed)	-
DB2 Monitor Resource	When activated (Fixed)	exec

Monitor resource	Monitor timing	Target resource
FTP Monitor Resource	Always or when activated	exec
HTTP Monitor Resource	Always or when activated	exec
IMAP4 Monitor Resource	Always or when activated	exec
MySQL Monitor Resource	When activated (Fixed)	exec
NFS Monitor Resource	Always or when activated	exec
Oracle Monitor Resource	When activated (Fixed)	exec
OracleAS Monitor Resource	When activated (Fixed)	exec
Oracle Clusterware Synchronization Management Monitor Resource	Always (Fixed)	-
POP3 Monitor Resource	When activated (Fixed)	exec
PostgreSQL Monitor Resource	When activated (Fixed)	exec
Samba Monitor Resource	Always or when activated	exec
SMTP Monitor Resource	Always or when activated	exec
Sybase Monitor Resource	When activated (Fixed)	exec
Tuxedo Monitor Resource	When activated (Fixed)	exec
Weblogic Monitor Resource	When activated (Fixed)	exec
Websphere Monitor Resource	When activated (Fixed)	exec
WebOTX Monitor Resource	When activated (Fixed)	exec
JVM Monitor Resource	Always or when activated	exec
System Monitor Resource	Always (Fixed)	All
Floating IP Monitor Resource	When activated (Fixed)	fip
AWS elastic ip monitor resource	When activated (Fixed)	awseip
AWS virtual ip monitor resource	When activated (Fixed)	awsvip
AWS AZ monitor resource	Always (Fixed)	-
Azure probe port monitor resource	When activated (Fixed)	azurepp
Azure load balance monitor resource	Always (Fixed)	azurepp

## Suspending and resuming monitoring on monitor resources

Monitor resource can temporarily suspend monitoring and resume it. Monitoring can be suspended and resumed by the following two methods:

- ◆ Operation on the WebManager
- ◆ Operation by the clpmonctrl command  
The clpmonctrl command can control only monitor resources on the server where this command is run.

Some monitor resources can suspend and resume monitoring and others cannot. For details, see the list below.

Monitor Resource	Control
Disk Monitor Resource	Possible
IP Monitor Resource	Possible
User-mode Monitor Resource	Possible
Mirror Disk Monitor Resource	Possible
Mirror Disk Connect Monitor Resource	Possible
Hybrid Disk Monitor Resource	Possible
Hybrid Disk Connect Monitor Resource	Possible
NIC Link Up/Down Monitor Resource	Possible
PID Monitor Resource	Possible
Multi Target Monitor Resource	Possible
Virtual IP Monitor Resource	Impossible
ARP Monitor Resource	Impossible
Custom Monitor Resource	Possible
VM Monitor Resource	Possible
Message Receive Monitor Resource	Possible
Volume Manager Monitor Resource	Possible
Dynamic DNS Monitor Resource	Impossible
Process Name Monitor Resource	Possible
BMC Monitor Resource	Possible
DB2 Monitor Resource	Possible
FTP Monitor Resource	Possible
HTTP Monitor Resource	Possible
IMAP4 Monitor Resource	Possible
MySQL Monitor Resource	Possible
NFS Monitor Resource	Possible
Oracle Monitor Resource	Possible
OracleAS Monitor Resource	Possible
Oracle Clusterware Synchronization Management Monitor Resource	Possible
POP3 Monitor Resource	Possible

Monitor Resource	Control
PostgreSQL Monitor Resource	Possible
Samba Monitor Resource	Possible
SMTP Monitor Resource	Possible
Sybase Monitor Resource	Possible
Tuxedo Monitor Resource	Possible
Websphere Monitor Resource	Possible
Weblogic Monitor Resource	Possible
WebOTX Monitor Resource	Possible
JVM Monitor Resource	Possible
System Monitor Resource	Possible
Floating IP Monitor Resource	Impossible
AWS elastic ip monitor resource	Possible
AWS virtual ip monitor resource	Possible
AWS AZ monitor resource	Possible
Azure probe port monitor resource	Possible
Azure load balance monitor resource	Possible

On the WebManager, shortcut menus of the monitor resources which cannot control monitoring are disabled. The `clpmonctrl` command only controls the resources which can control monitoring. For monitor resources which cannot control monitoring, a warning message is displayed and controls are not performed.

Suspending monitoring on a monitor resource is disabled if one of the following operations is performed.

- ◆ Resume operation on WebManager
- ◆ Resume operation by using the `clpmonctrl` command
- ◆ Stop the cluster
- ◆ Suspend the cluster

## Enabling and disabling dummy failure of monitor resources

You can enable and disable dummy failure of monitor resources. Use one of the following methods to enable or disable dummy failure.

- ◆ Operation on WebManager (verification mode)  
On the WebManager(verification mode), shortcut menus of the monitor resources which cannot control monitoring are disabled.
- ◆ Operation by using the `clpmonctrl` command  
The `clpmonctrl` command can control only monitor resources on the server where this command is run. When the `clpmonctrl` command is executed on monitor resource which cannot be controlled, dummy failure is not enabled even though the command succeeds.

Some monitor resources can enable and disable dummy failure and others cannot. For details, see “Controlling monitor resources (`clpmonctrl` command)” in Chapter 3.



Dummy failure of a monitor resource is disabled if the following operations are performed.

- ◆ Dummy failure was disabled on WebManager (verification mode)
- ◆ “Yes” was selected from the dialog box displayed when the WebManager mode changes from verification mode to a different mode.
- ◆ -n was specified to enable dummy failure by using the clpmonctrl command
- ◆ Stop the cluster
- ◆ Suspend the cluster

## Monitoring interval for monitor resource

All monitor resources except the user-mode monitor resource monitors their targets at every monitor interval.

The following illustrates the timeline of how a monitor resource monitors its target and finds error/no error with the configuration below:

- ◆ When no error is detected

Examples of behavior when the following values are set.

```
<Monitor>
Monitor Interval      30 sec
Monitor Timeout      60 sec
Monitor Retry Count   0 times
```

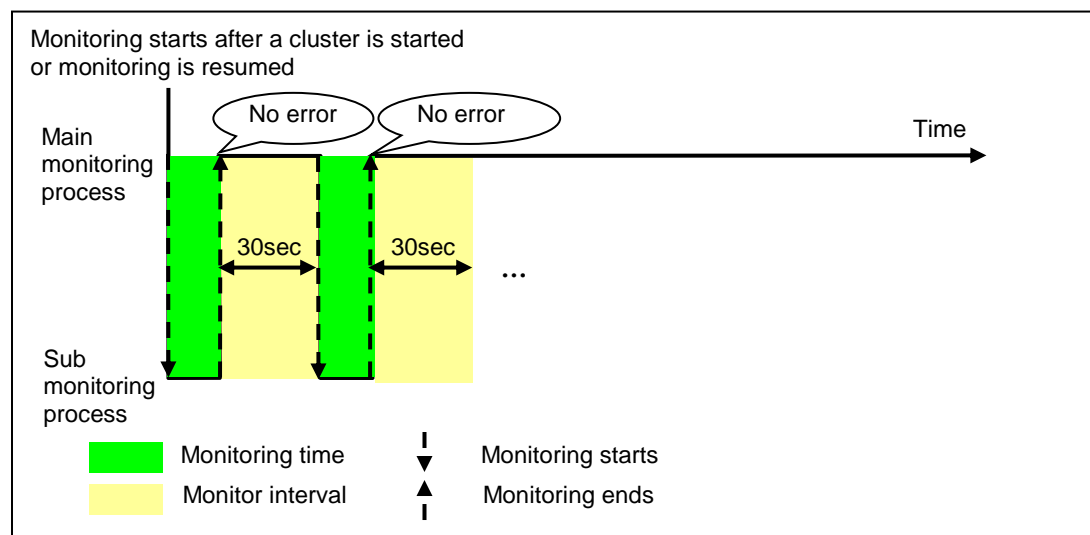

**When an error is detected (without monitor retry setting)**

Examples of behavior when the following values are set.

<Monitor>  
 Monitor Interval 30 sec  
 Monitor Timeout 60 sec  
 Monitor Retry count 0 times

<Error detection>  
 Recovery Target group  
 Recovery Script Execution Count 0 times  
 Maximum Reactivation Count 0 times  
 Maximum Failover Count 1 time  
 Final Action None

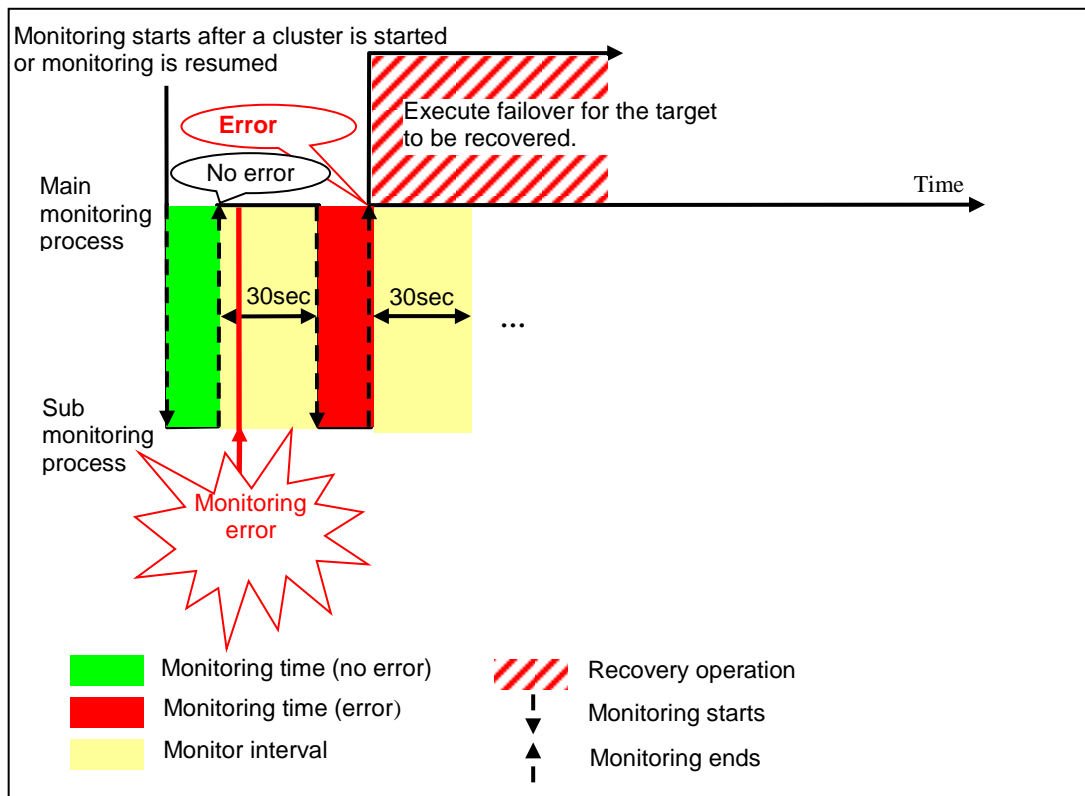

When an error occurs, it is detected at the next monitoring and the recovery operation for the recovery target starts.

**When an error is detected (with monitor retry settings)**

Examples of behavior when the following values are set.

<Monitor>  
 Monitor Interval 30 sec  
 Monitor Timeout 60 sec  
 Monitor Retry Count 2 times

<Error detection>  
 Recovery Target group  
 Recovery Script Execution Count 0 times  
 Maximum Reactivation Count 0 times  
 Maximum Failover Count 1 time  
 Final Action None

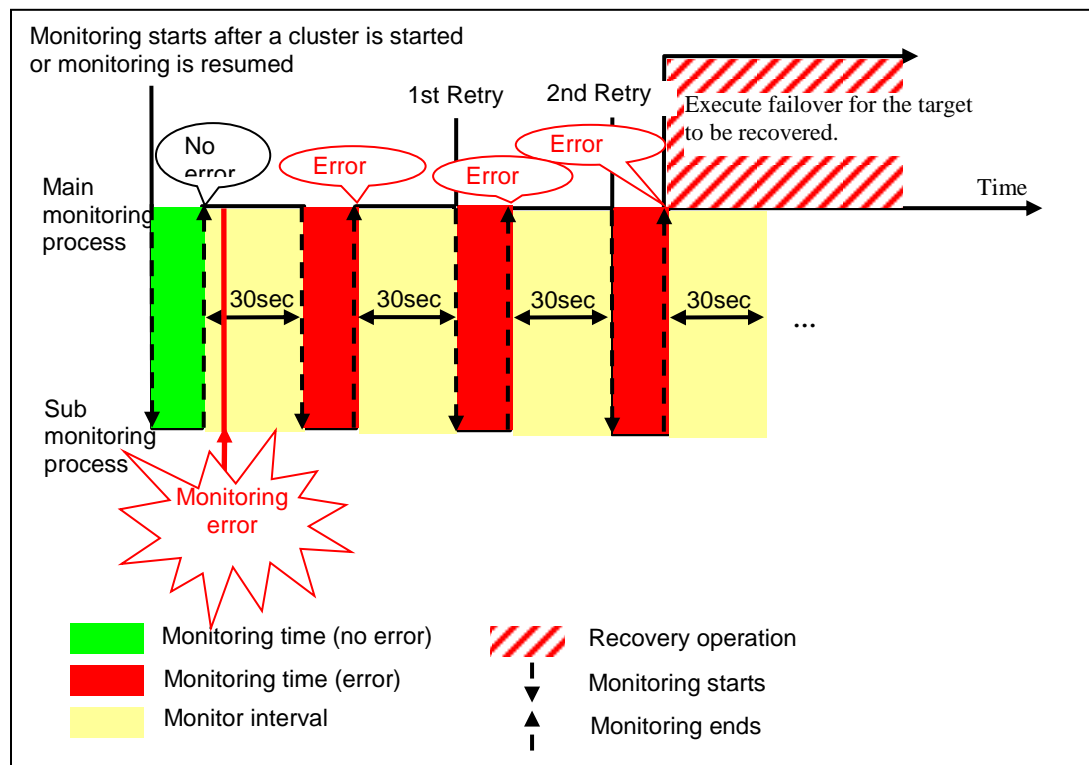

When an error occurs, it is detected at the next monitoring. If recovery cannot be achieved within the monitor retries, the failover is started for the recovery target.

**When an error is detected (without monitor retry settings)**

Examples of behavior when the following values are set.

<Monitor>  
 Monitor Interval 30 sec  
 Monitor Timeout 60 sec  
 Monitor Retry Count 0 times

<Error detection>  
 Recovery Target group  
 Recovery Script Execution Count 0 times  
 Maximum Reactivation Count 0 times  
 Maximum Failover Count 1 time  
 Final Action none

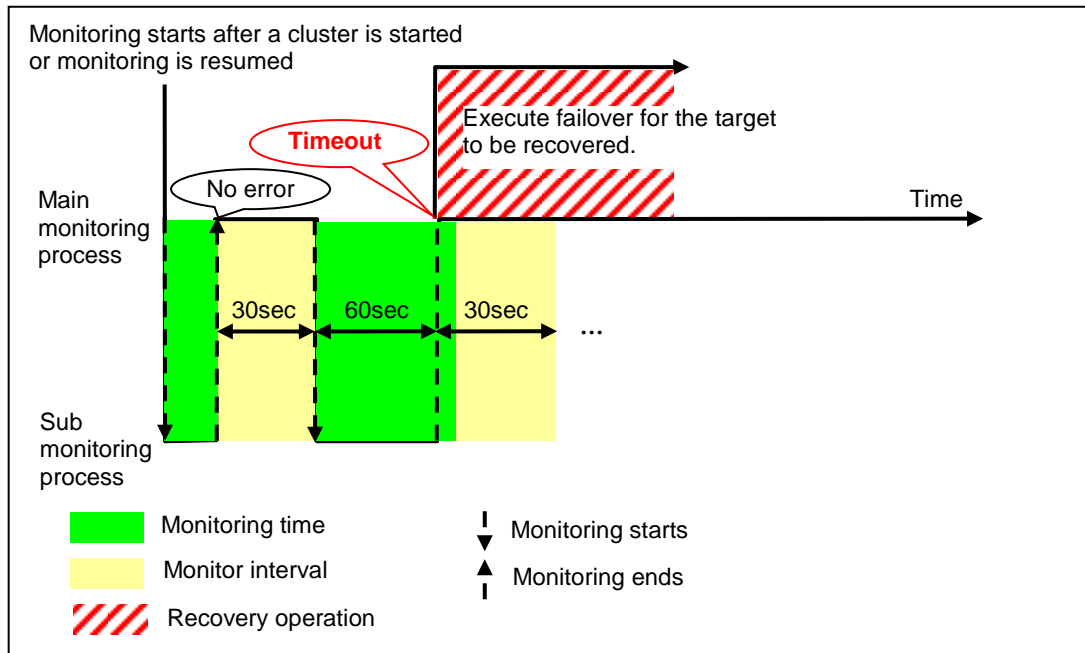

Immediately after an occurrence of a monitoring timeout, the failover for the recovery target starts.

**When a monitoring timeout is detected (with monitor retry setting)**

Examples of behavior when the following values are set.

<Monitor>  
 Monitor Interval 30 sec  
 Monitor Timeout 60 sec  
 Monitor Retry Count 1 time

<Error detection>  
 Recovery Target group  
 Recovery Script Execution Count 0 times  
 Maximum Reactivation Count 0 times  
 Maximum Failover Count 1 time  
 Final Action none

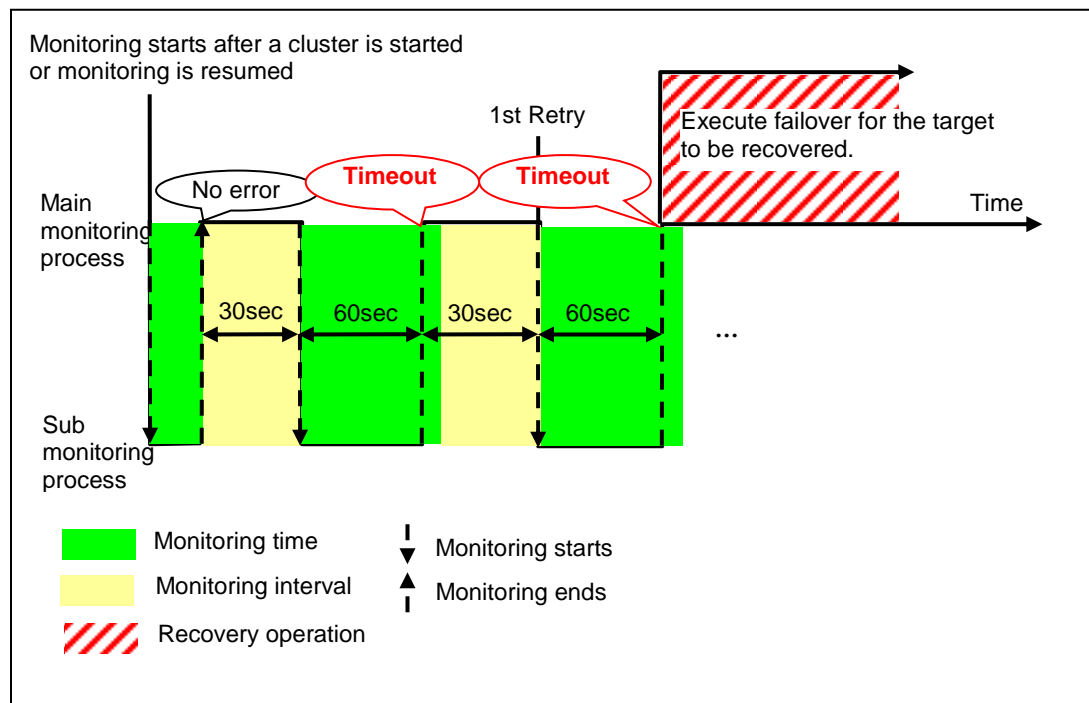

When a monitoring timeout occurs, monitor retry is performed and failover is started for the recovery target.

## Action when an error is detected by monitor resource

When an error is detected, the following recovery actions are taken against the recovery target in sequence:

- ◆ Execution of recovery script: this takes place when an error is detected in a monitor target.
- ◆ Reactivation of the recovery target: this takes place if the recovery script is executed up to the recovery script execution count. When the execution of a pre-reactivation script is specified, reactivation starts after that script has been executed.
- ◆ Failover: this takes place when reactivation fails for the number of times set in the reactivation threshold. When the execution of a pre-failover script is specified, failover starts after that script has been executed.
- ◆ Final action: this takes place when the error is detected even after the failover is executed for the number of times set in the failover threshold. When the execution of a pre-final-action script is specified, the final action starts after that script has been executed.

No recovery action is taken if the status of the recovery target is:

Recovery target	Status	Reactivation <sup>1</sup>	Failover <sup>2</sup>	Final action <sup>3</sup>
Group resource/ Failover group	Already stopped	No	No	No
	Being activated/stopped	No	No	No
	Already activated	Yes	Yes	Yes
	Error	Yes	Yes	Yes
Local Server	-	-	-	Yes

Yes: Recovery action is taken    No: Recovery action is not taken

### Note:

Do not work on the following operations by running commands or using the WebManager when a group resource (e.g. disk resource, EXEC resource) is set as a recovery target in the settings of error detection for the monitor resource, and recovery is in progress (reactivation -> failover -> final action) after detection of an error:

- ◆ Stopping/suspending the cluster
- ◆ Starting/stopping/moving a group

If you perform the above-mentioned operations while recovery caused by detection of an error by a monitor resource is in progress, other group resources of the group with an error may not stop.

However, the above-mentioned operations can be performed when the final action is completed.

When the status of the monitor resource recovers from an error (becomes normal), the reactivation count, failover count, and whether the final action is executed are all reset.

An unsuccessful recovery action is also counted into reactivation count or failover count.

<sup>1</sup> Effective only when the value for the reactivation threshold is set to 1 (one) or greater.

<sup>2</sup> Effective only when the value for the failover threshold is set to 1 (one) or greater.

<sup>3</sup> Effective only when an option other than **No Operation** is selected.

The following is an example of the progress when only one server detects an error while the gateway is specified as an IP resource of the IP monitor resource:

Examples of behavior when the following values are set.

<Monitor>

Interval 30 sec  
 Timeout 30 sec  
 Retry Count 3 times

<Error detection>

Recovery Target Failover Group A  
 Recovery Script Execution Count 3 times  
 Reactivation Threshold 3 times  
 Failover Threshold 1  
 Final Action No Operation

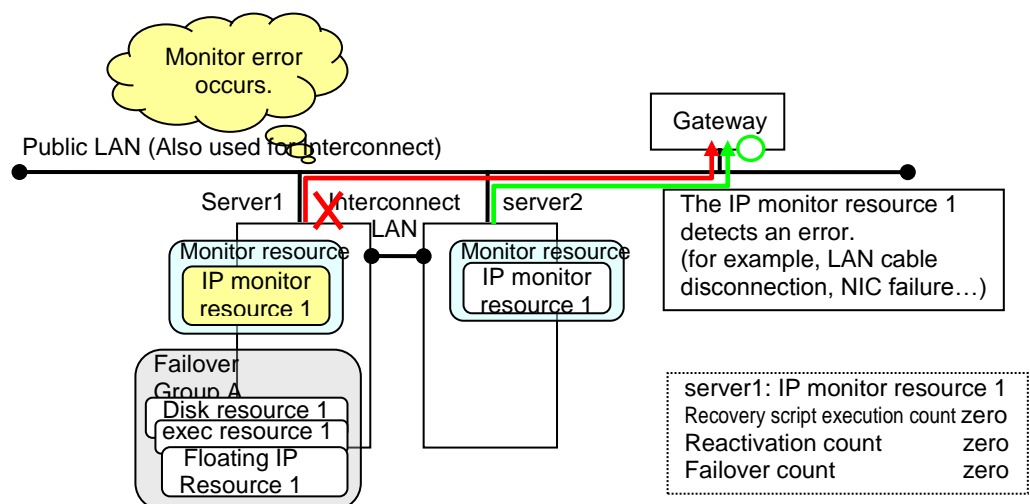
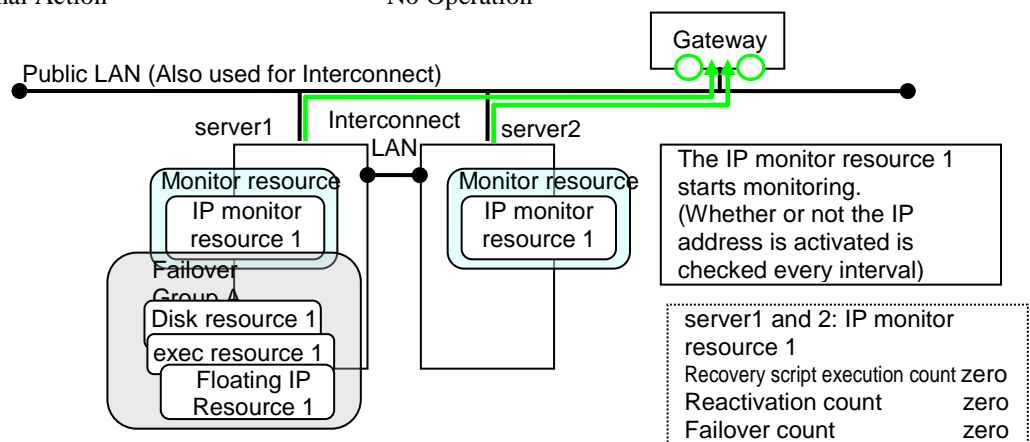

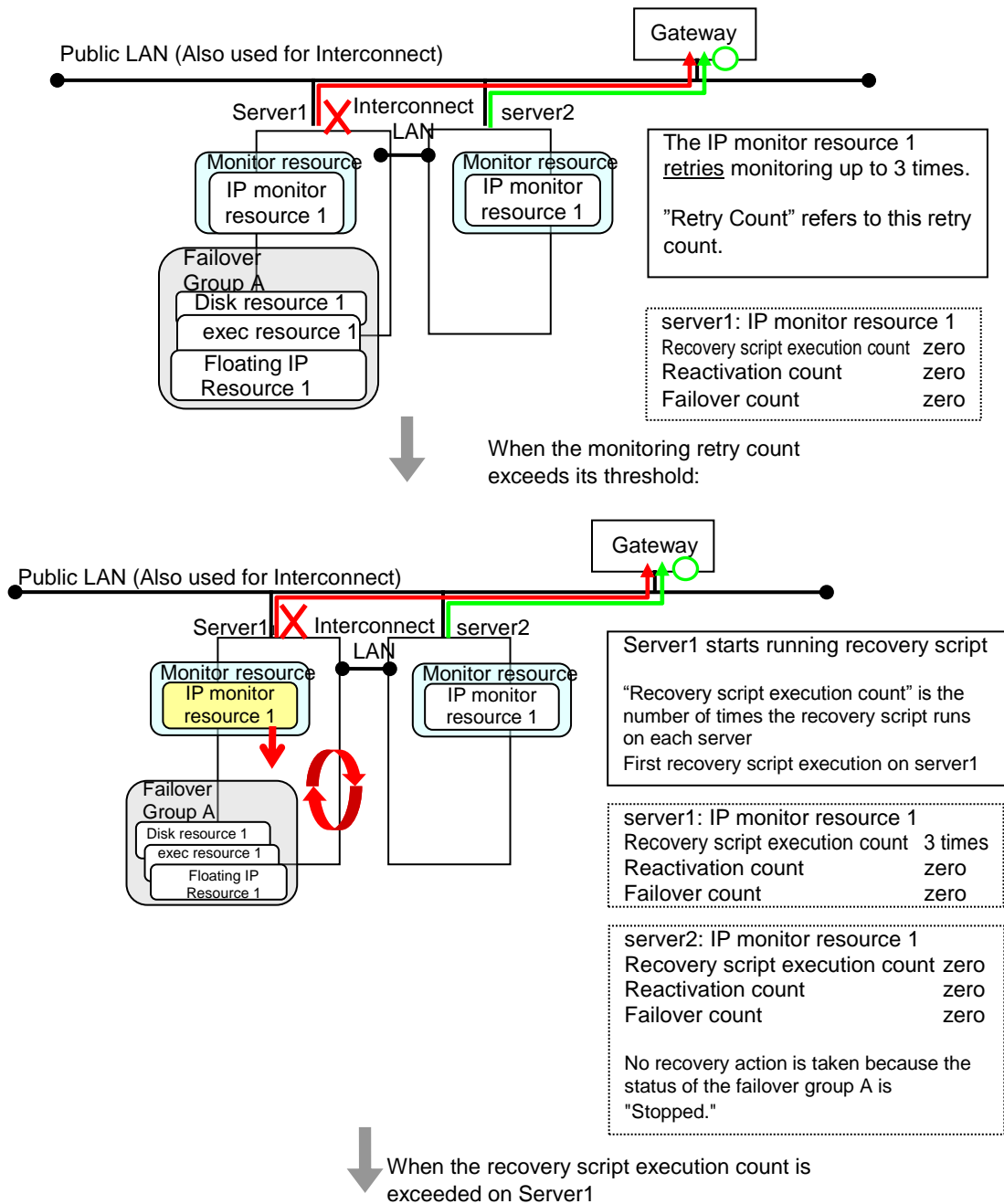



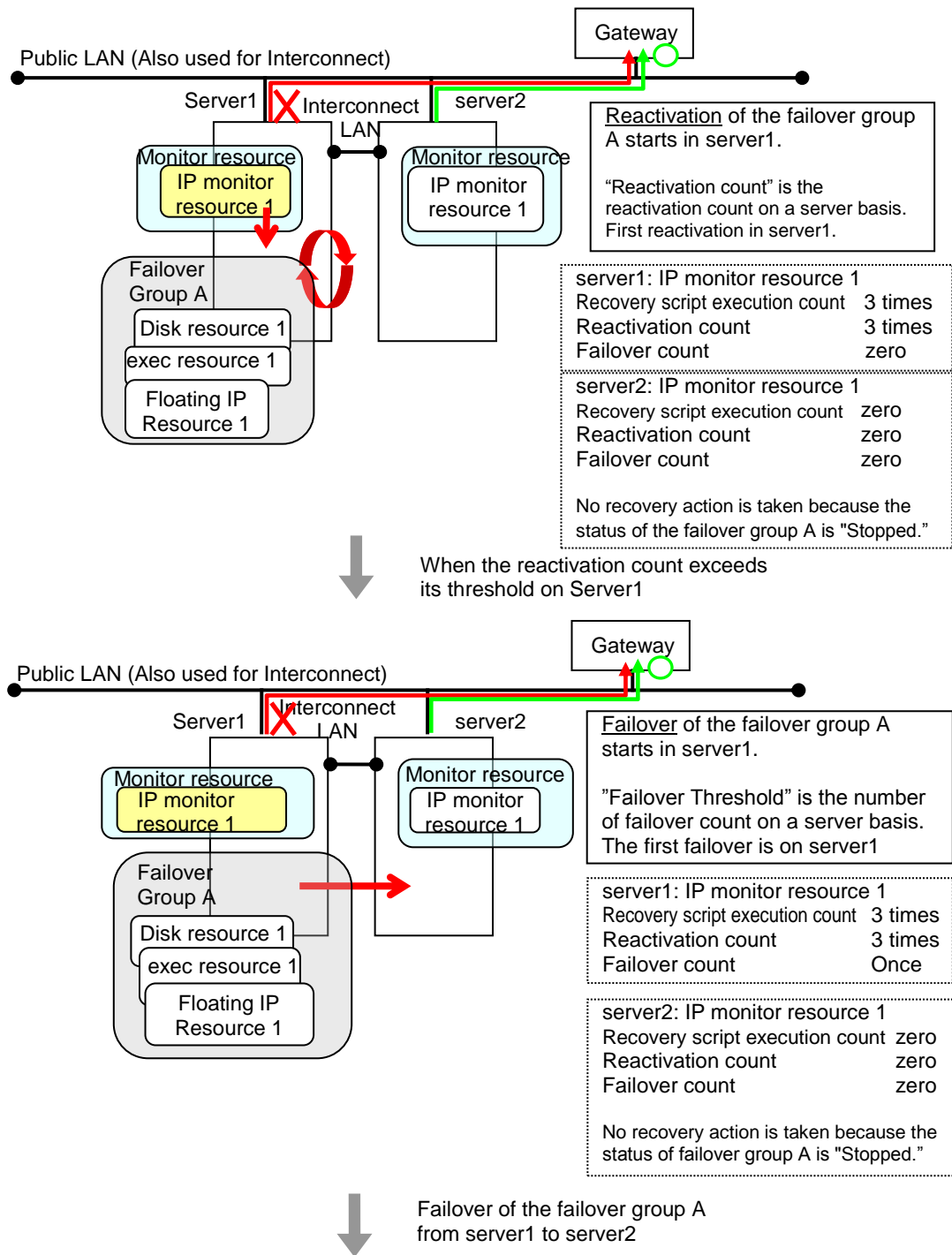

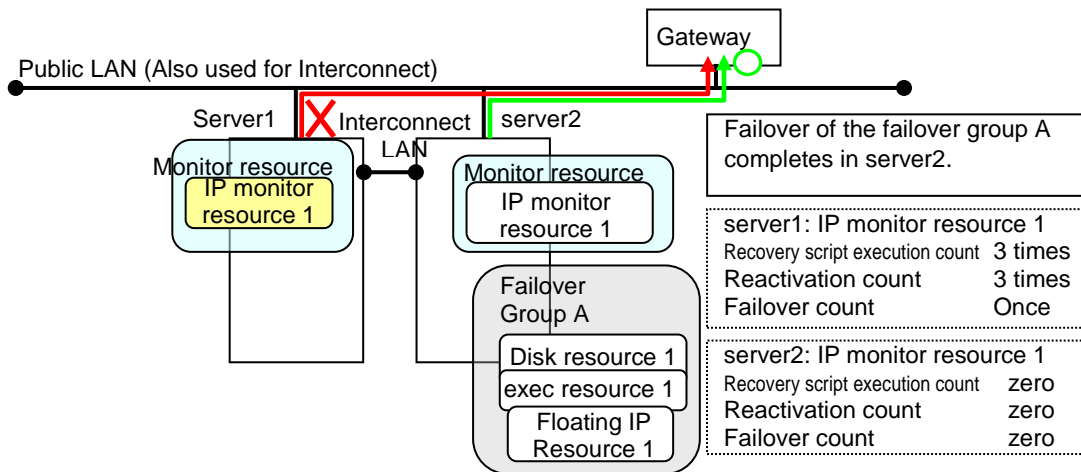

In server2, the operation can continue by failover of the Failover Group A because the IP monitor resource 1 is running properly.

The following is an example of the process when both servers detect an error while the gateway is specified as an IP resource of the IP monitor resource.

Examples of behavior when the following values are set.

- <Monitor>
- Interval 30 sec
- Timeout 30 sec
- Retry Count 3 times
  
- <Error detection>
- Recovery Target Failover Group A
- Recovery Script Execution Count 3 times
- Reactivation threshold 3 times
- Failover Threshold 1
- Final Action No Operation

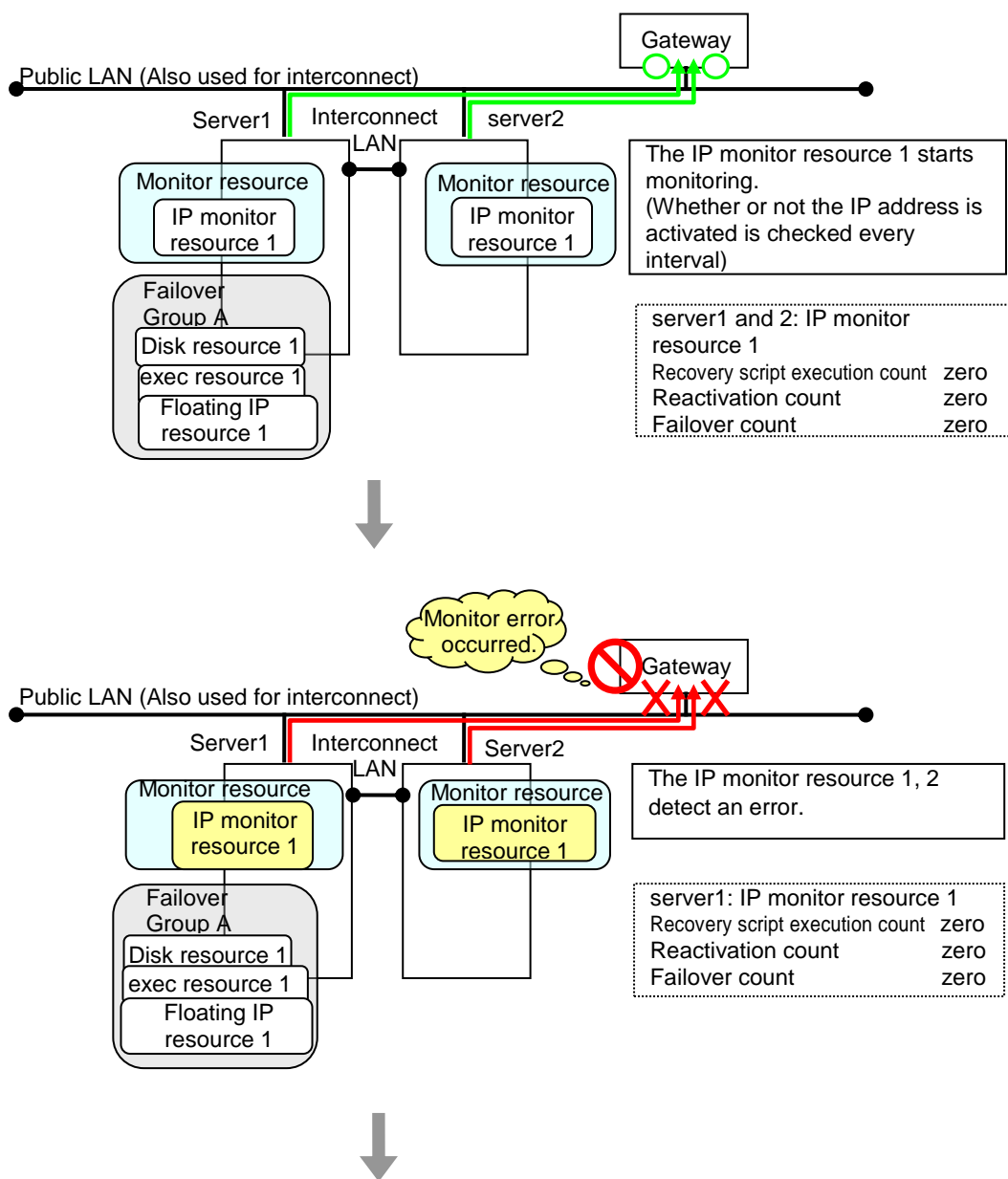

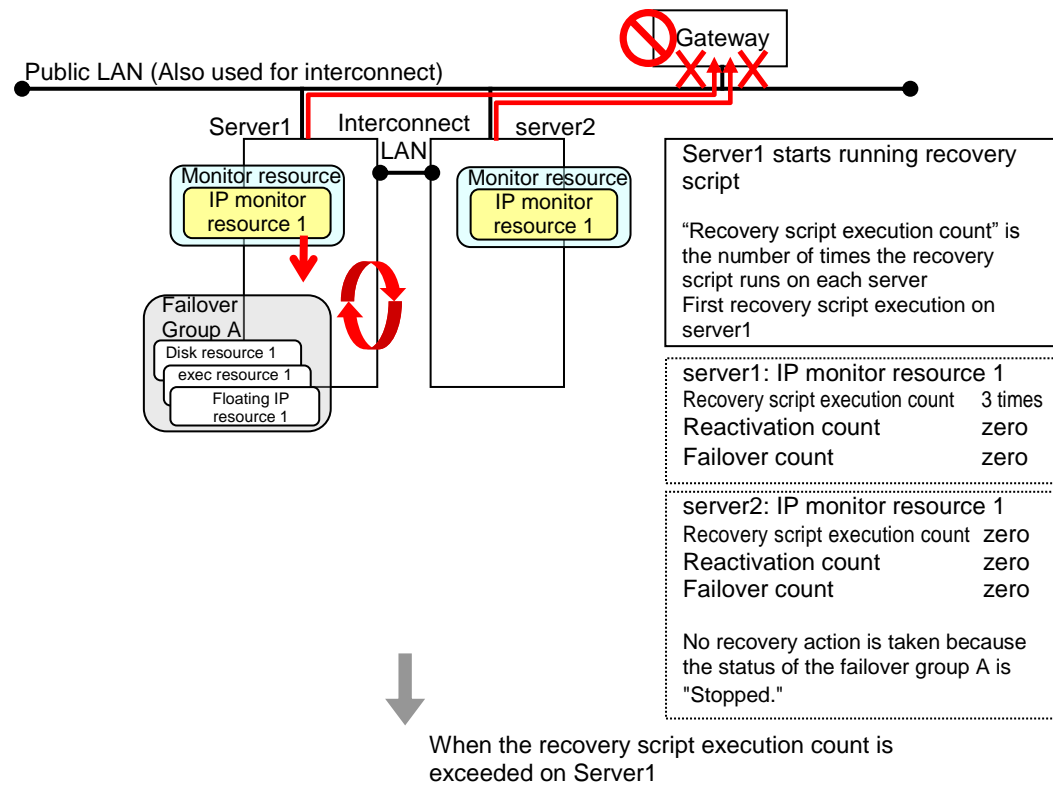
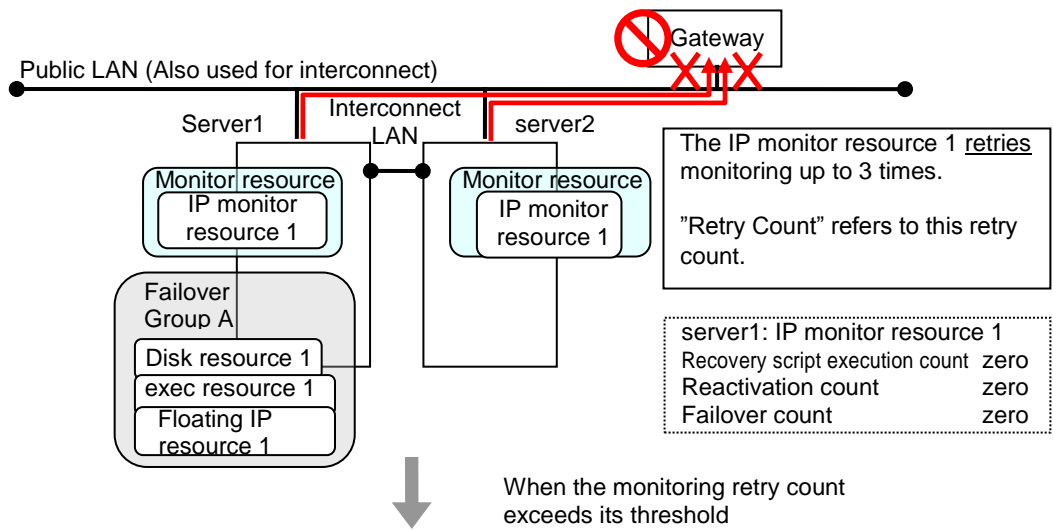

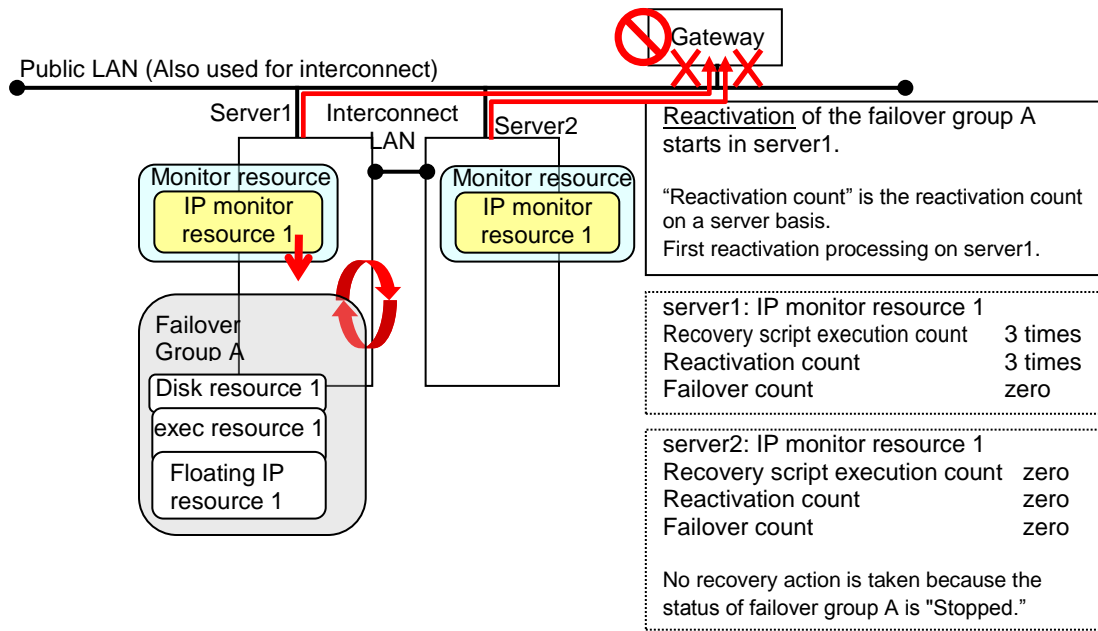

When reactivation count exceeds the threshold in server1

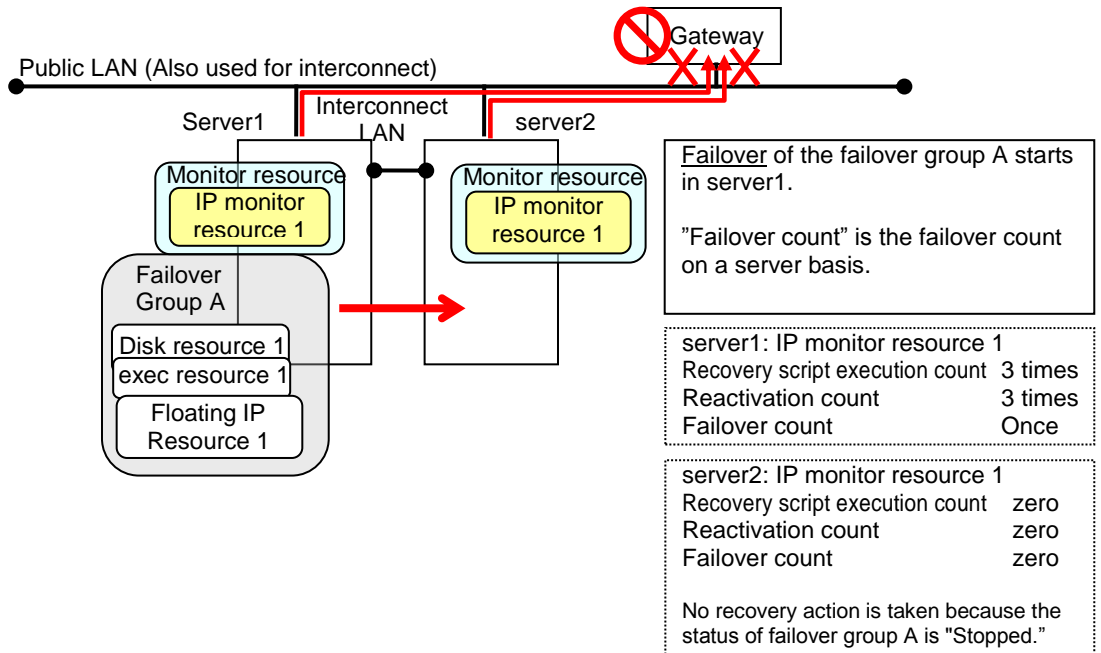

Failover the failover group A from server1 to server2

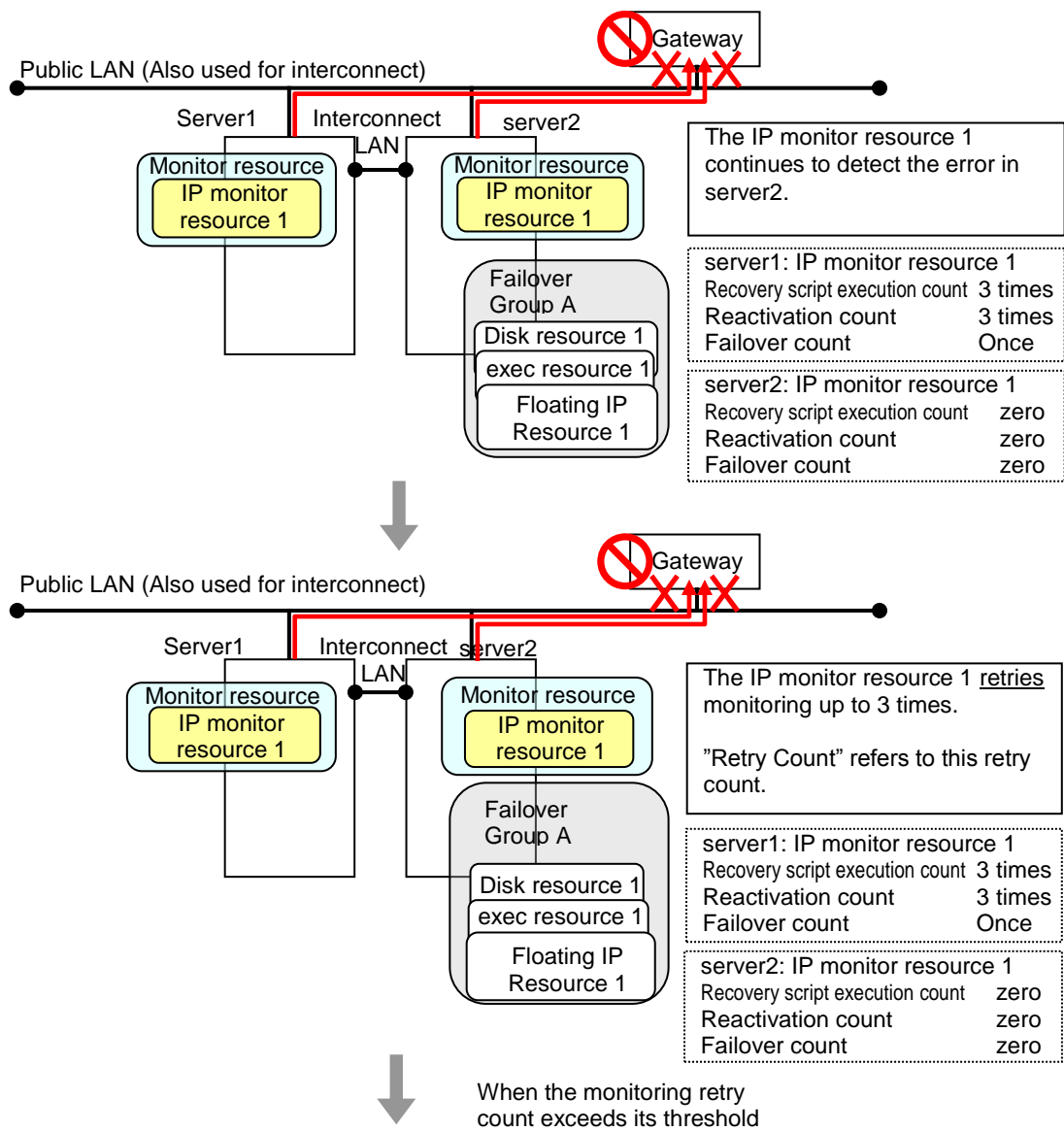

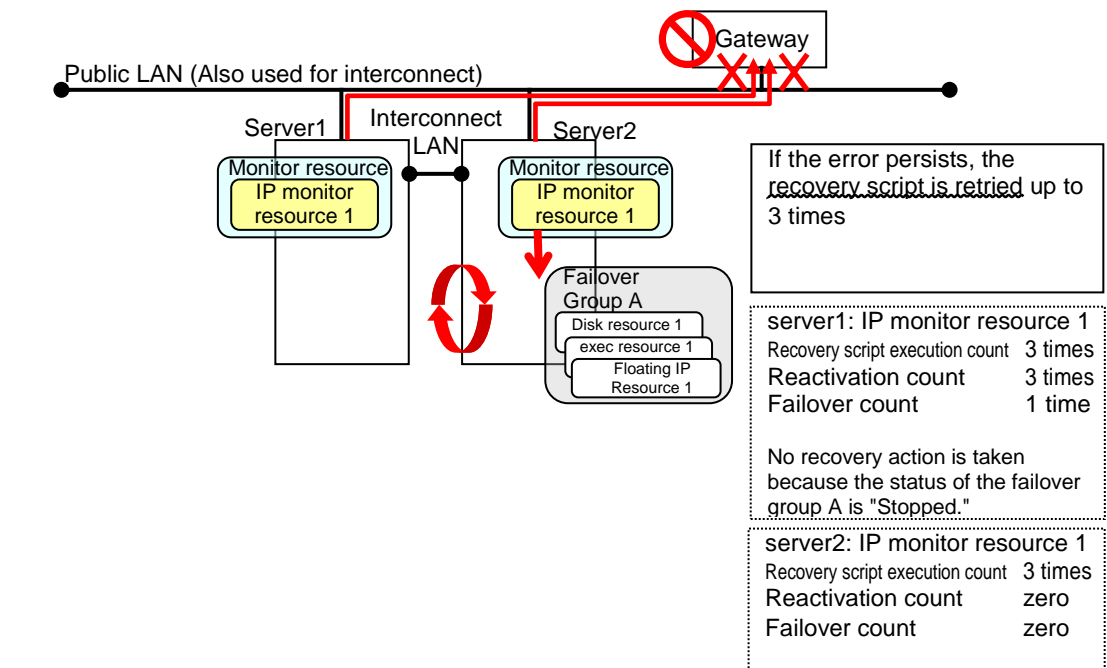

When server2 also fails to retry running of the recovery script

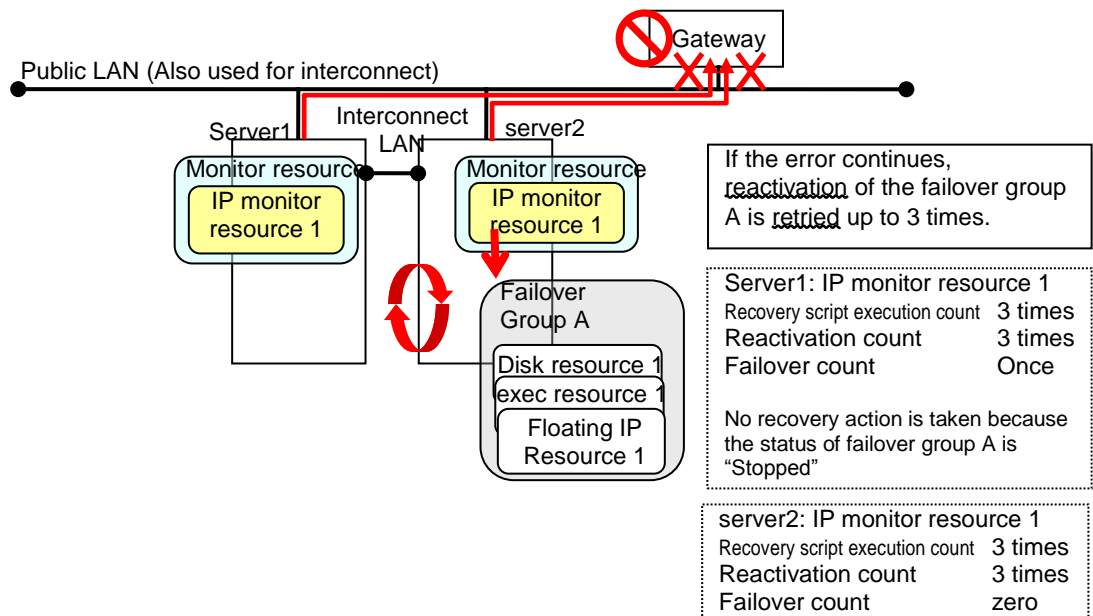

When reactivation count also exceeds its threshold in server2

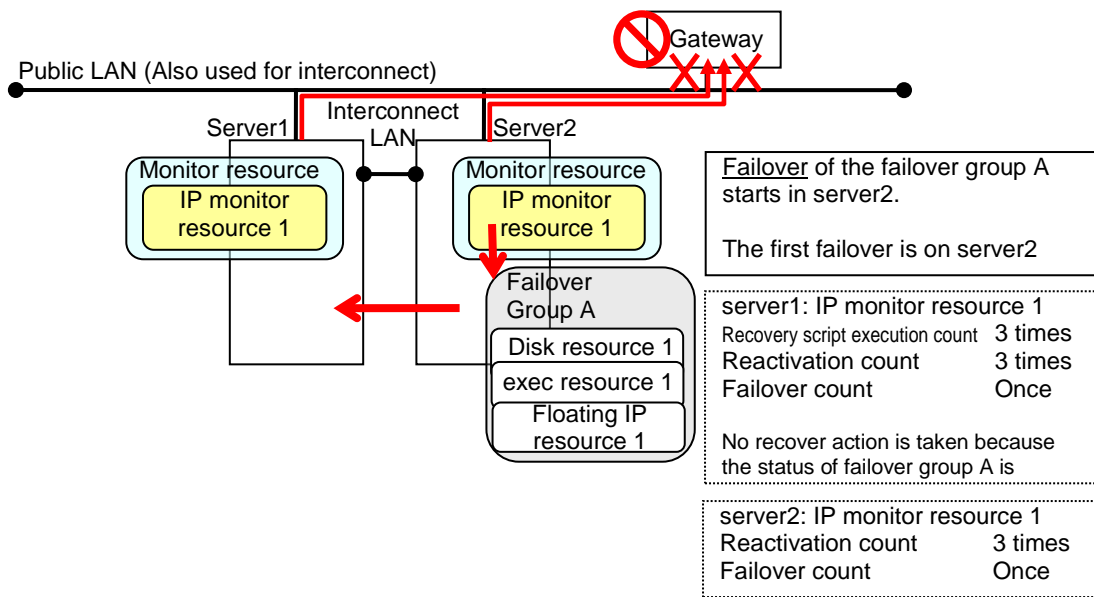

Failover the failover group A from server2 to server1

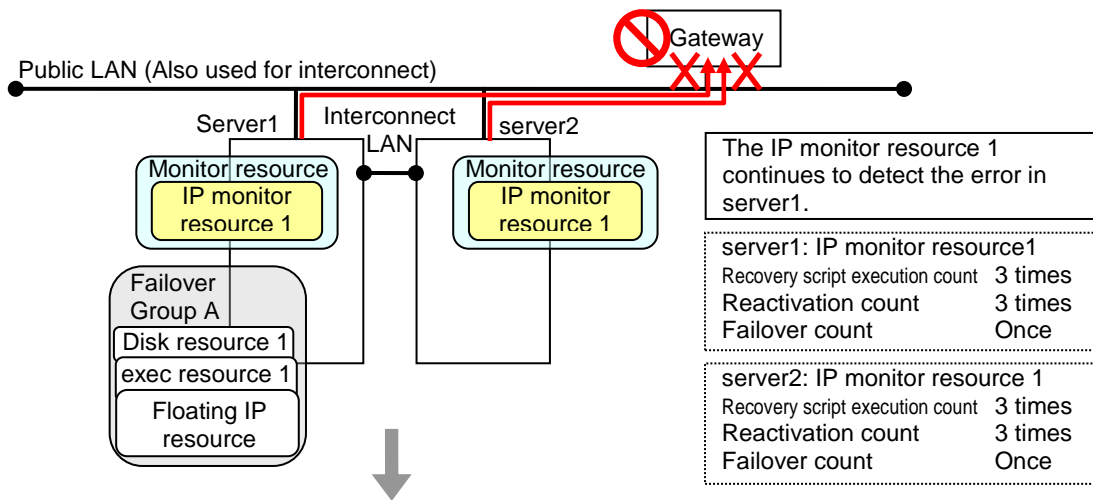



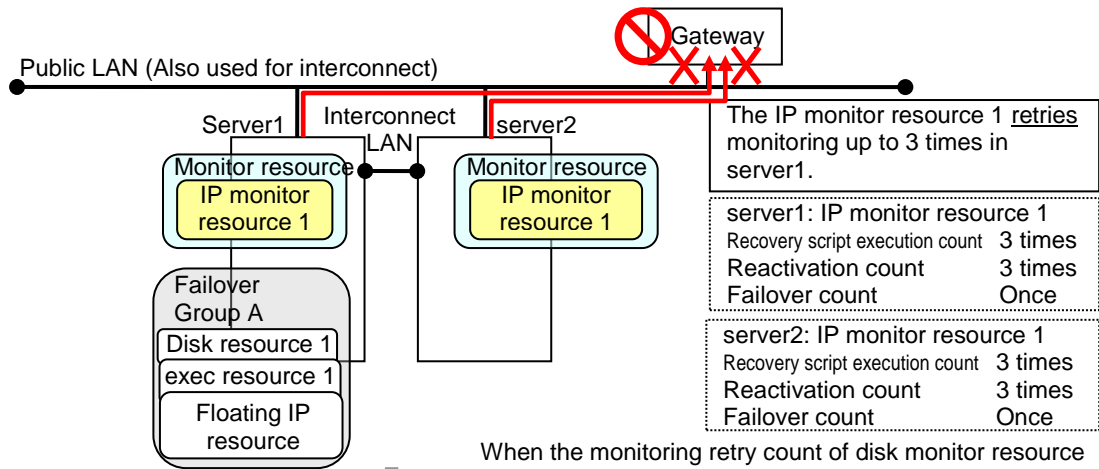

When the monitoring retry count of disk monitor resource 1 exceeds its threshold again in server1:  
 No reactivation is attempted because the reactivation threshold is 3.  
 No failover is attempted because the failover threshold is 1. The final action starts.

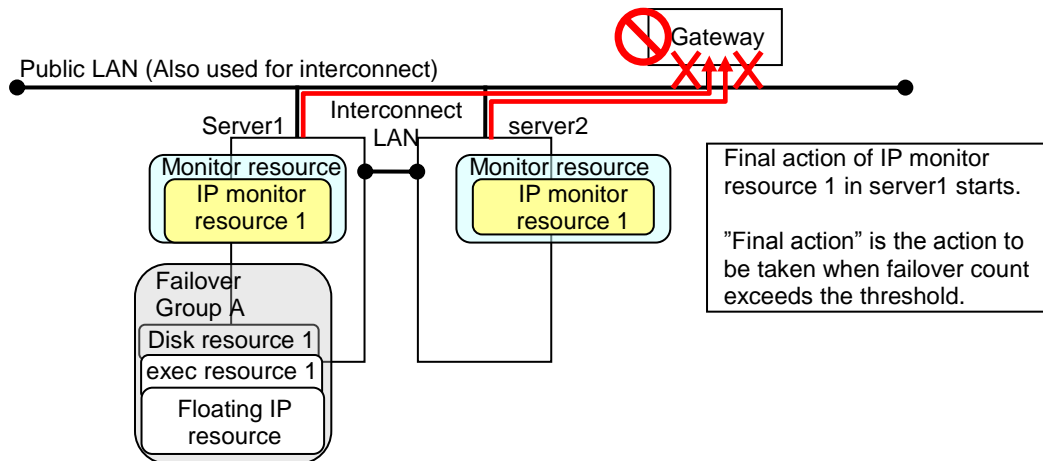

**Additional Information**

When the status of the monitor target becomes normal from an error and the monitor resource detects the change, the reactivation count and failover count are reset to zero (0). When an error is detected next time, the process will be exactly the same as what has been described up to here.

The description up to here assumed the interconnect LANs are working properly.

If all interconnect LANs are disconnected, internal communications with other servers are blocked. As a result, even if an error is detected on a monitor target, failover of groups fails.

To fail over a group when all interconnect LANs are disconnected, you can choose to shut down the server where an error is detected. This will allow other servers to detect the server is shut down and to start failover of the group.

The following is an example of the process when an error is detected while all interconnect LANs are disconnected.

Configuration

```
<Monitor>
Interval                30 seconds
Timeout                 30 seconds
Retry Count             3 times

<Error detection>
Recovery Object         Failover Group A
Recovery Script Execution Count  3 times
Reactivation Threshold  3 times
Failover Threshold      1 time
Final Action            Stop cluster daemon and shutdown OS
```

Reactivation for the recovery target is same as the situation when the interconnect LANs are working properly. The description begins from the failover on server1, which requires interconnect LANs.

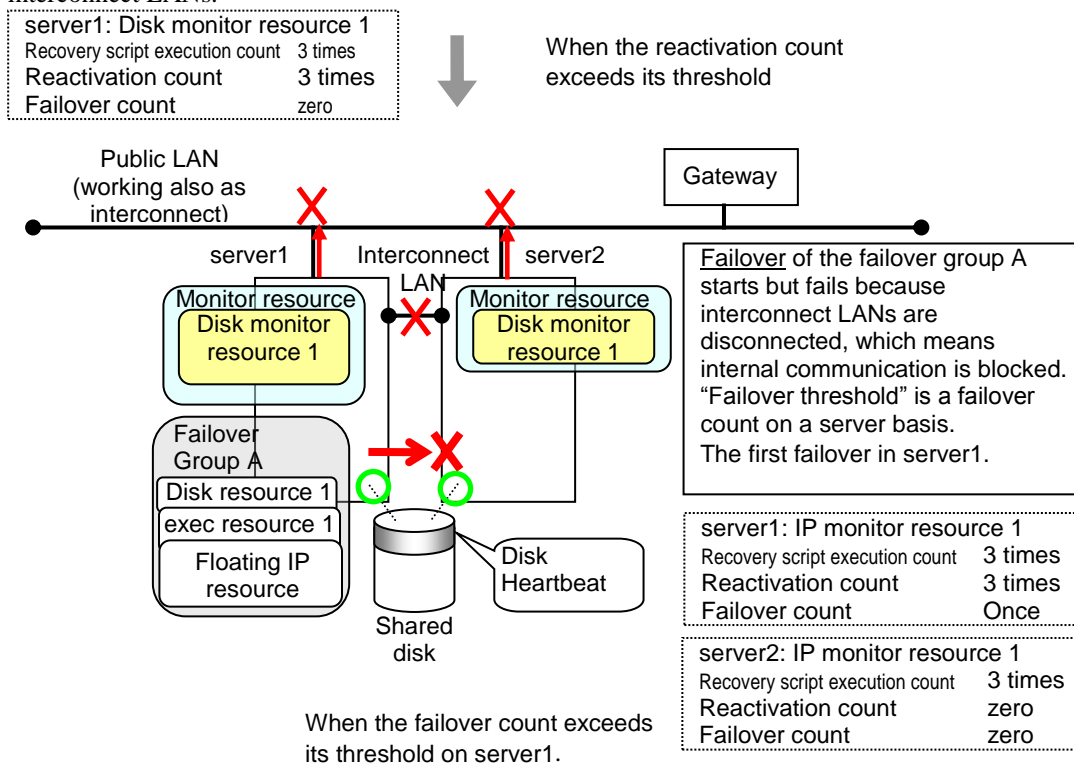

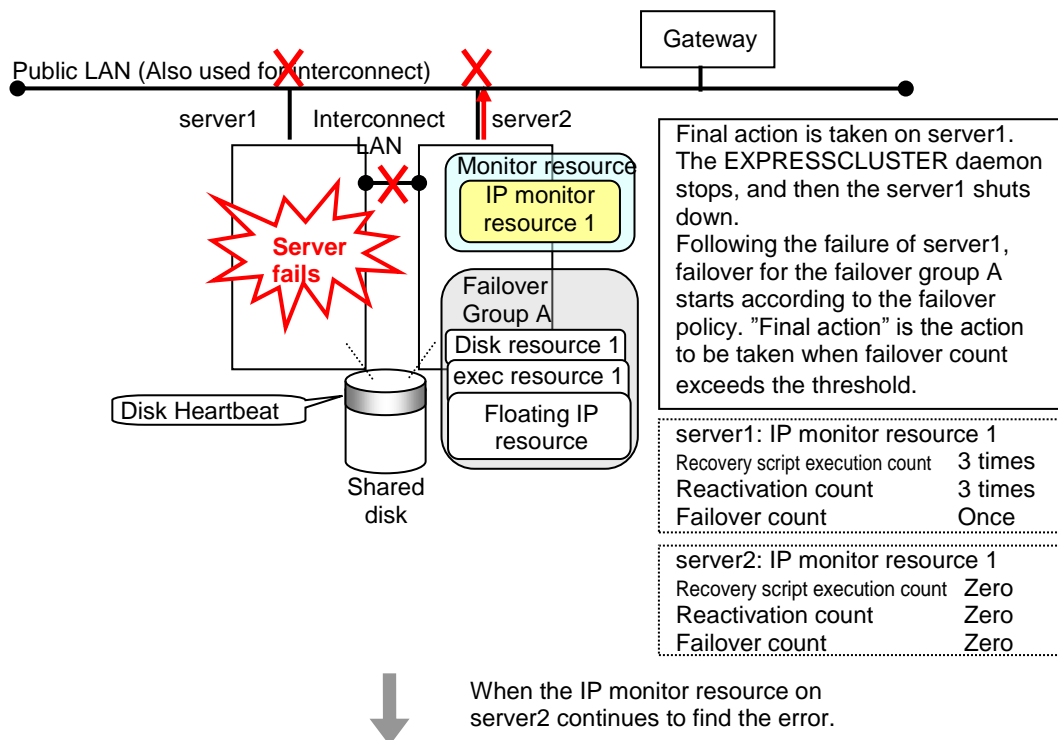

Reactivation of the Failover Group A is executed on server2 in the same way as server1.

Failover is attempted on server2 as well when reactivation of the group A fails. However, the failover cannot be executed because there is no destination server for the failover.

When the failover count exceeds its threshold, the final action is taken on server2 as is the case on server1.

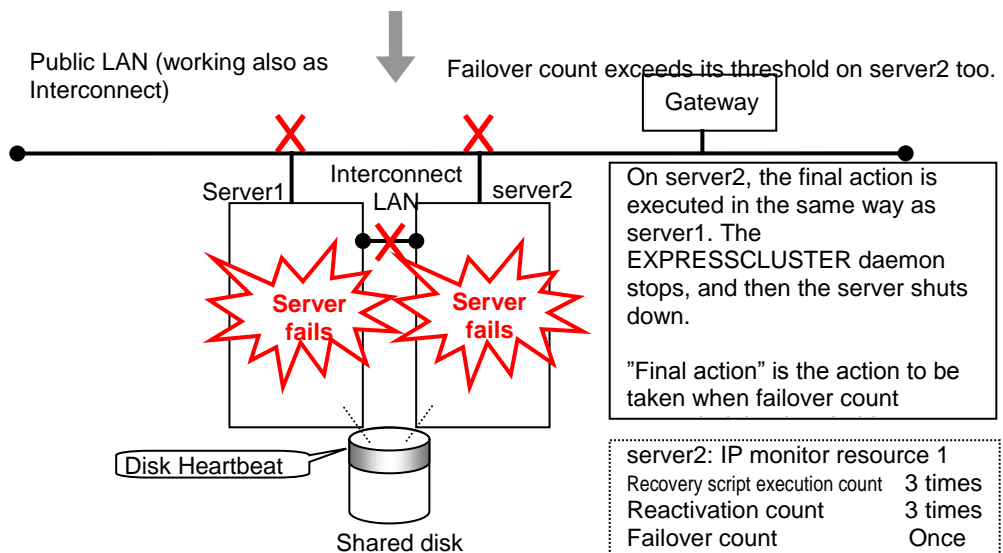

## Returning from monitor error (Normal)

When return of the monitor resource is detected during or after recovery actions following the detection of a monitoring error, counts for the thresholds shown below are reset:

- ◆ Recovery Script Execution Count
- ◆ Reactivation Threshold Count
- ◆ Failover Threshold

Whether or not to execute the final action is reset (execution required).

The following pages describe what will be executed from the point when the final action as described in "Action when an error is detected by monitor resource" on page 834 is executed and another monitoring error occurs after monitoring returns to normal.

Examples of behavior when the following values are set.

### Configuration

<Monitor>

Interval	30 sec
Timeout	30 sec
Retry Count	3 times

<Error detection>

Recovery Target	Failover Group A
Recovery Script Execution Count	3 times
Reactivation Threshold	3 times
Failover Threshold	1
Final Action	Stop Failover Group

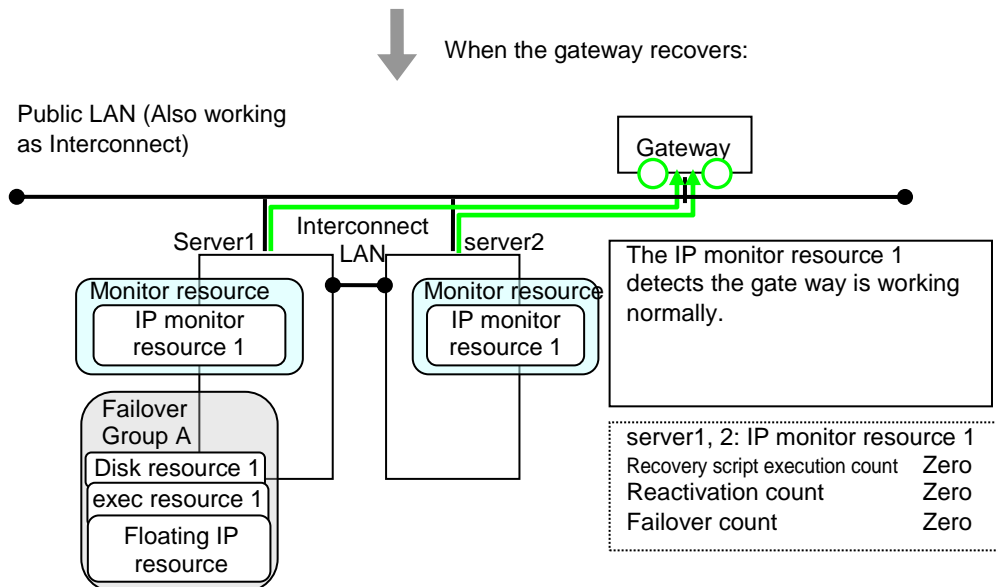
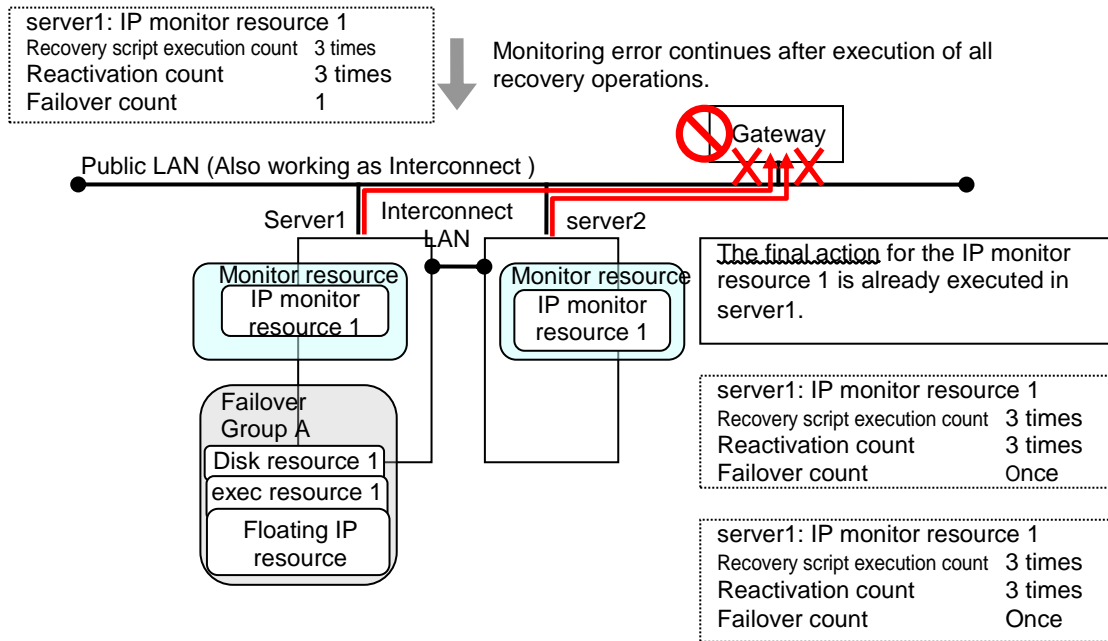

The number of reactivations and failovers are reset because it has been detected that the status of the monitor target resource became normal.

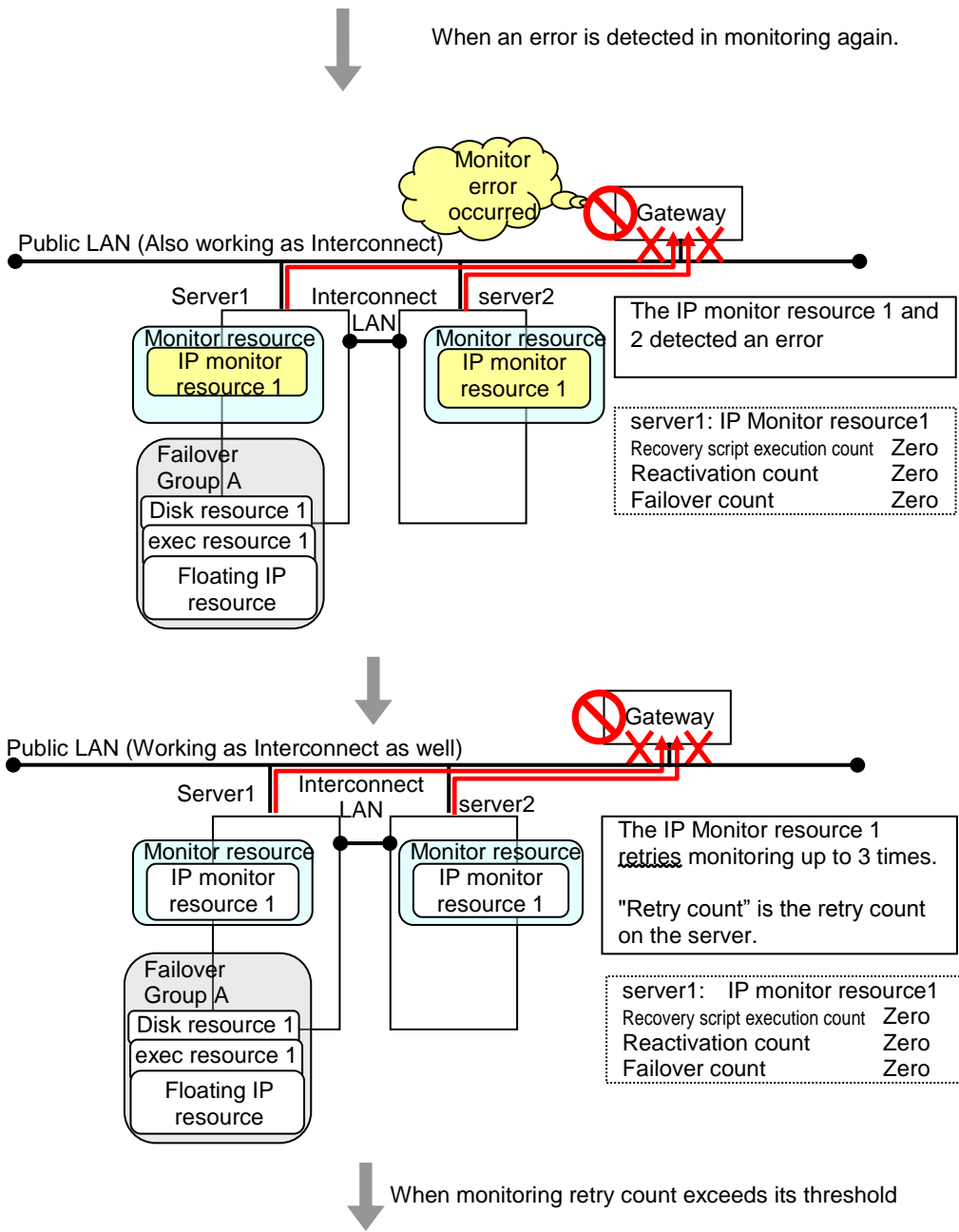

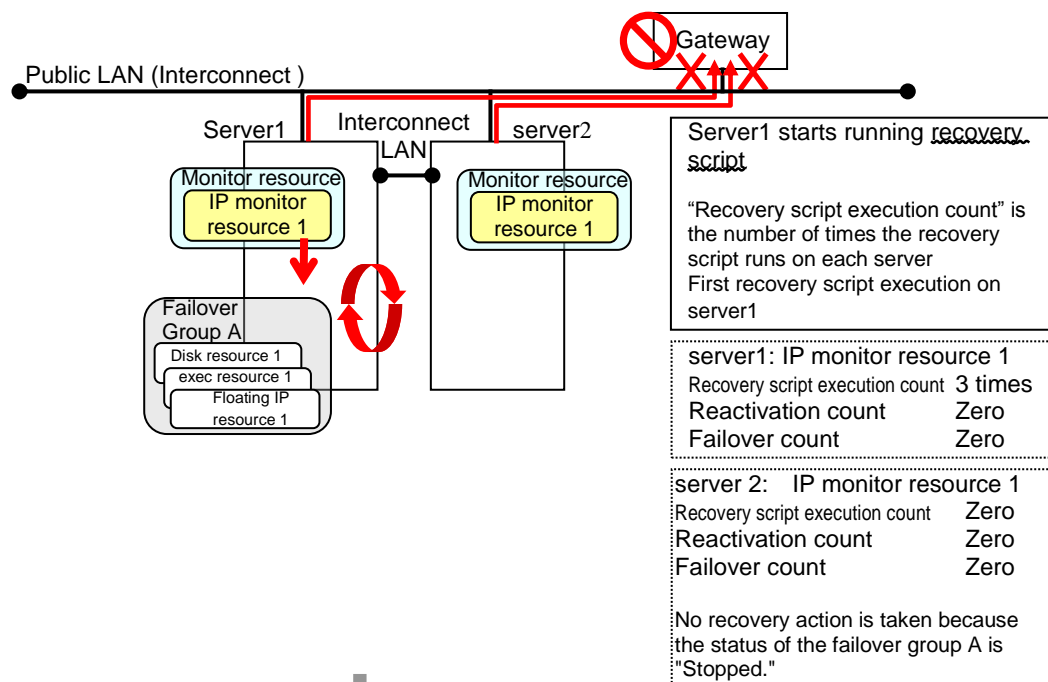

If the recovery script execution count is exceeded on server1, failover group A is reactivated

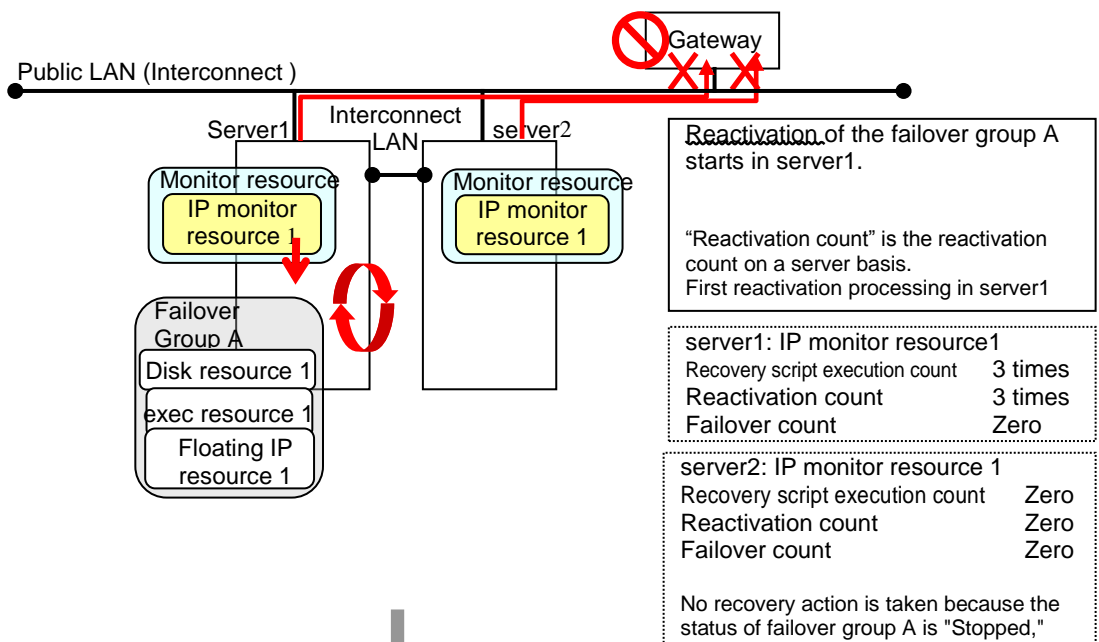

When reactivation count exceeds the threshold on server1, failover of the failover group A takes place

Reactivation is executed again because it has been detected that the status of the monitor target resource became normal and reactivation count has been reset before.

## Activation and deactivation error of recovery target when executing recovery operation

When the monitoring target of the monitor resource is the device used for the group resource of the recovery target, an activation/deactivation error of the group resource may be detected during recovery when a monitoring error is detected.

The following is an example of the recovery progress when the same device is specified as the monitor target of the disk monitor resource and the disk resource of the Failover Group A:

Configuration of the disk monitor resource

<Monitor>

Interval	60 seconds
Timeout	120 seconds
Retry Count	0 times

<Error detection>

Recovery Target	Failover Group A
Recovery Script Execution Count	0 times
Maximum Reactivation Count	0 times
Maximum Failover Count	1 time
Final Action	Stop Failover Group

<Parameter>

Method TUR

Configuration of the failover group A: disk resource

<Activation error>

Activation retry Threshold	0 times
Failover Threshold	1 time
Final Action	No Operation (Next resources are not activated)

<Deactivation abnormality>

Deactivation Retry Threshold	0 times
Final Action	Stop cluster daemon and shutdown OS



The reactivation threshold of the monitor resource and the activation retry threshold of the group resource are not mentioned in the following diagrams because they are set to zero (0).

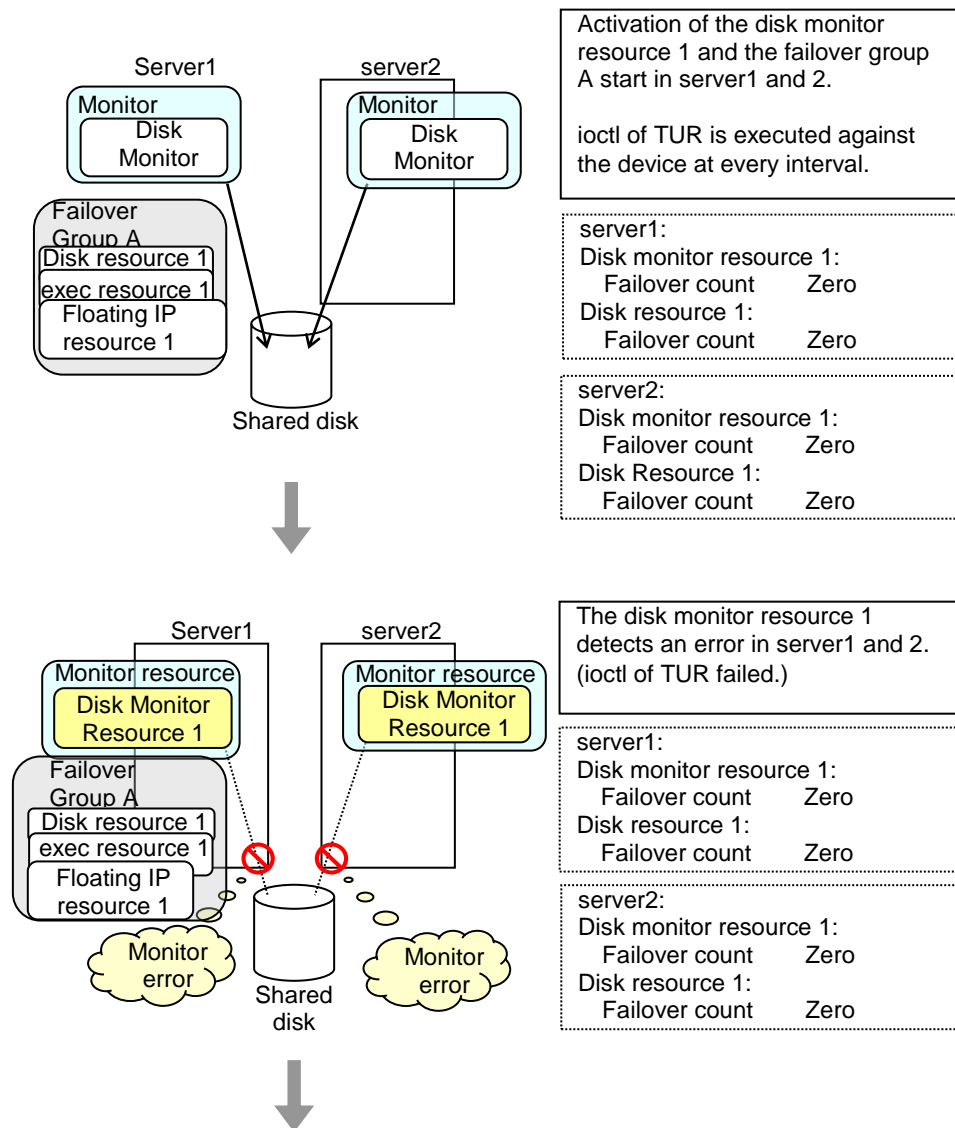

An error can be detected in deactivation of the disk resource depending on the location of the disk device failure.

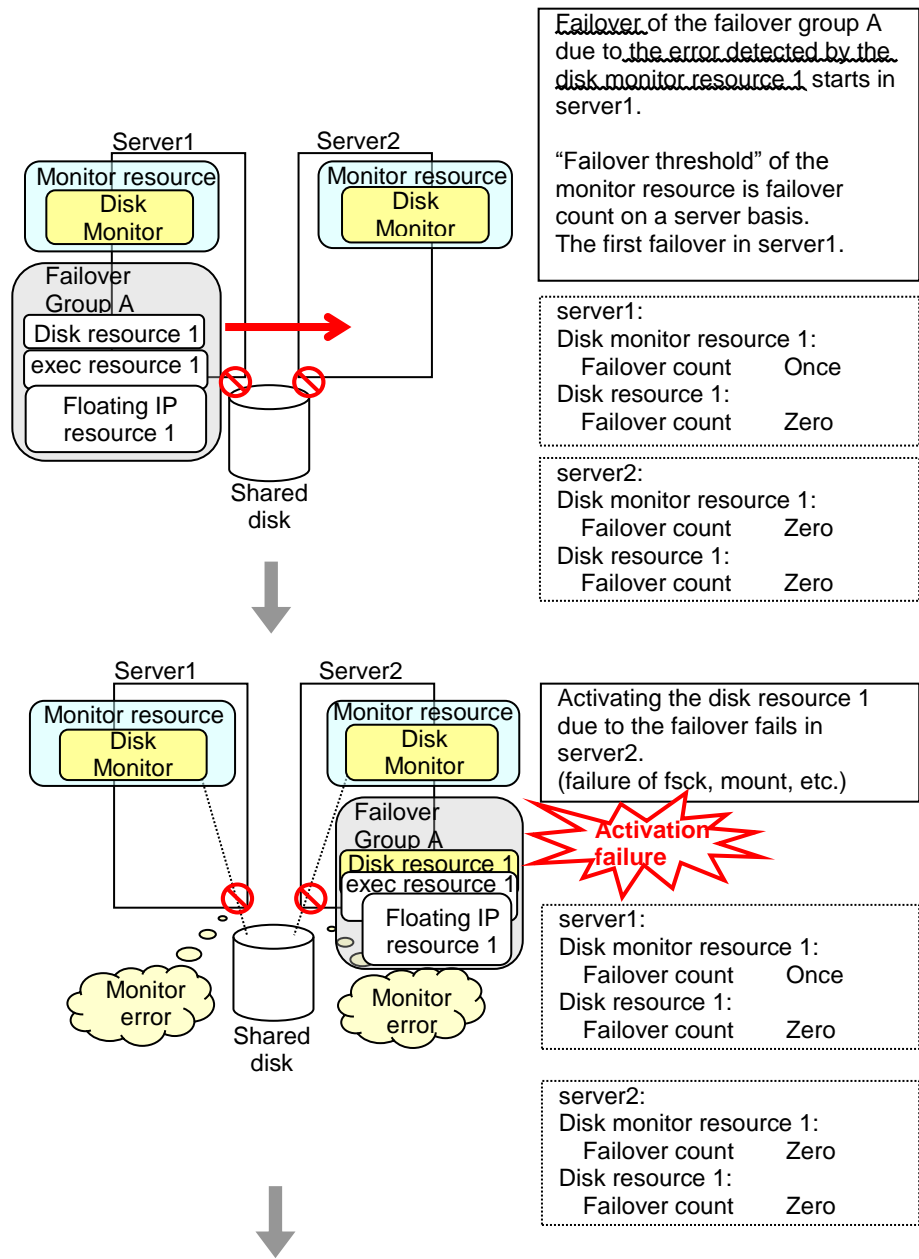

An error can be detected in deactivation of the disk resource depending on the location of the disk device failure.

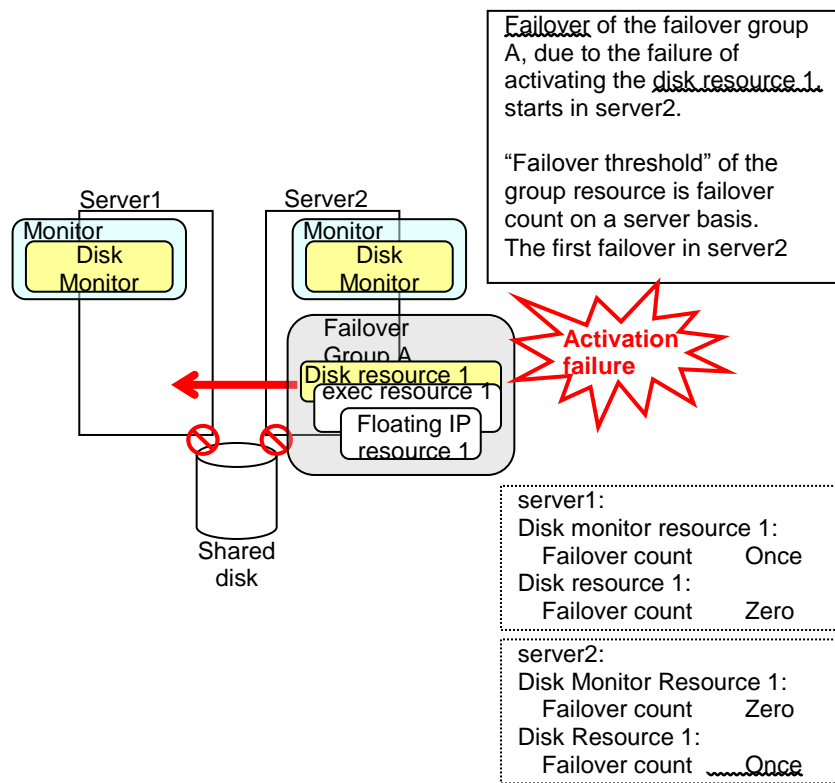

The disk monitor resource 1 detects an error in server2 as is the case in server1. However, no recovery action is taken because the failover group A, the recovery target, is activated.

For more information on recovery executed by monitor resources against their recovery targets, see “Action when an error is detected by monitor resource” on page 834.

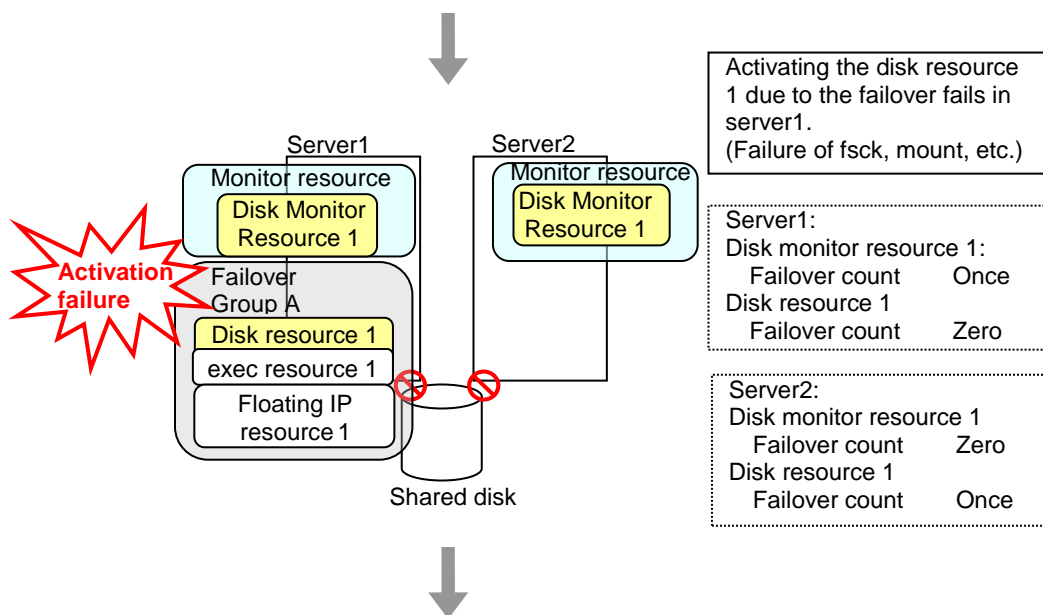

An error can be detected in deactivation of the disk resource depending on the location of the disk device failure.

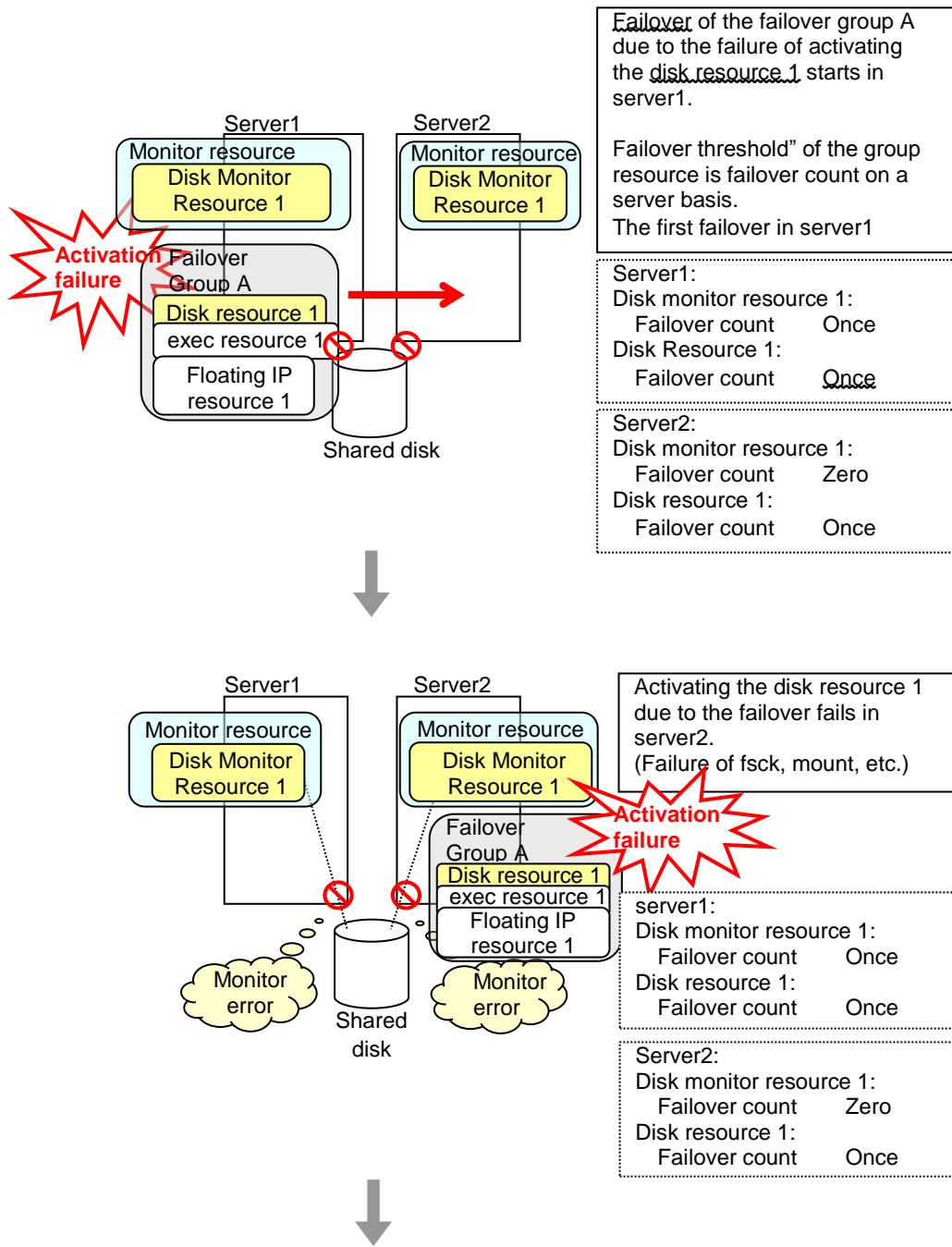

An error can be detected in deactivation of the disk resource depending on the location of the disk device failure.

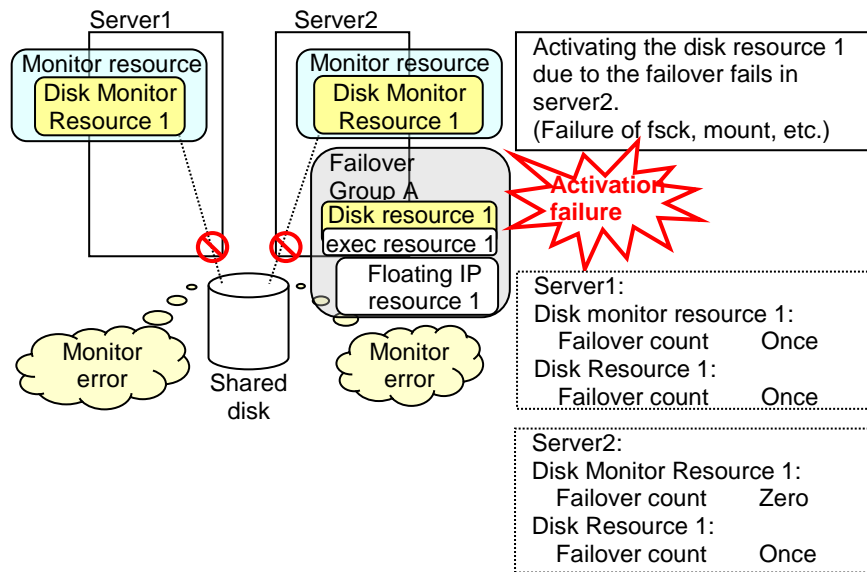

The final action is executed in server2 because the number of failovers due to failure of disk resource activation has exceeded its threshold.

However, note that activation ends abnormally without activating the rest of the group resources in the Failover Group A because “No operation (Next resources are not activated)” is selected as the final action.

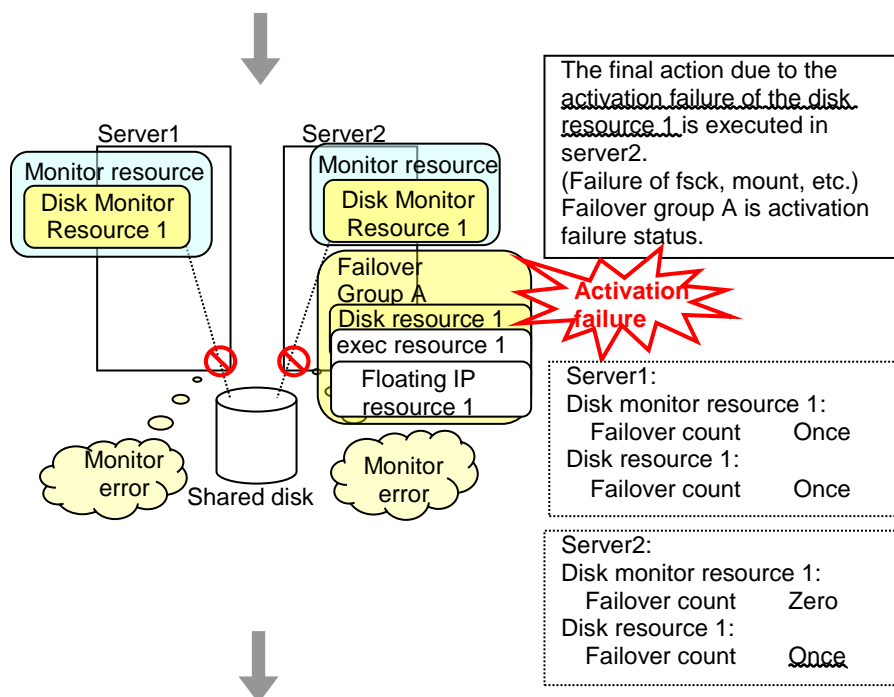

An error can be detected in deactivation of the disk resource depending on the location of the disk device failure.

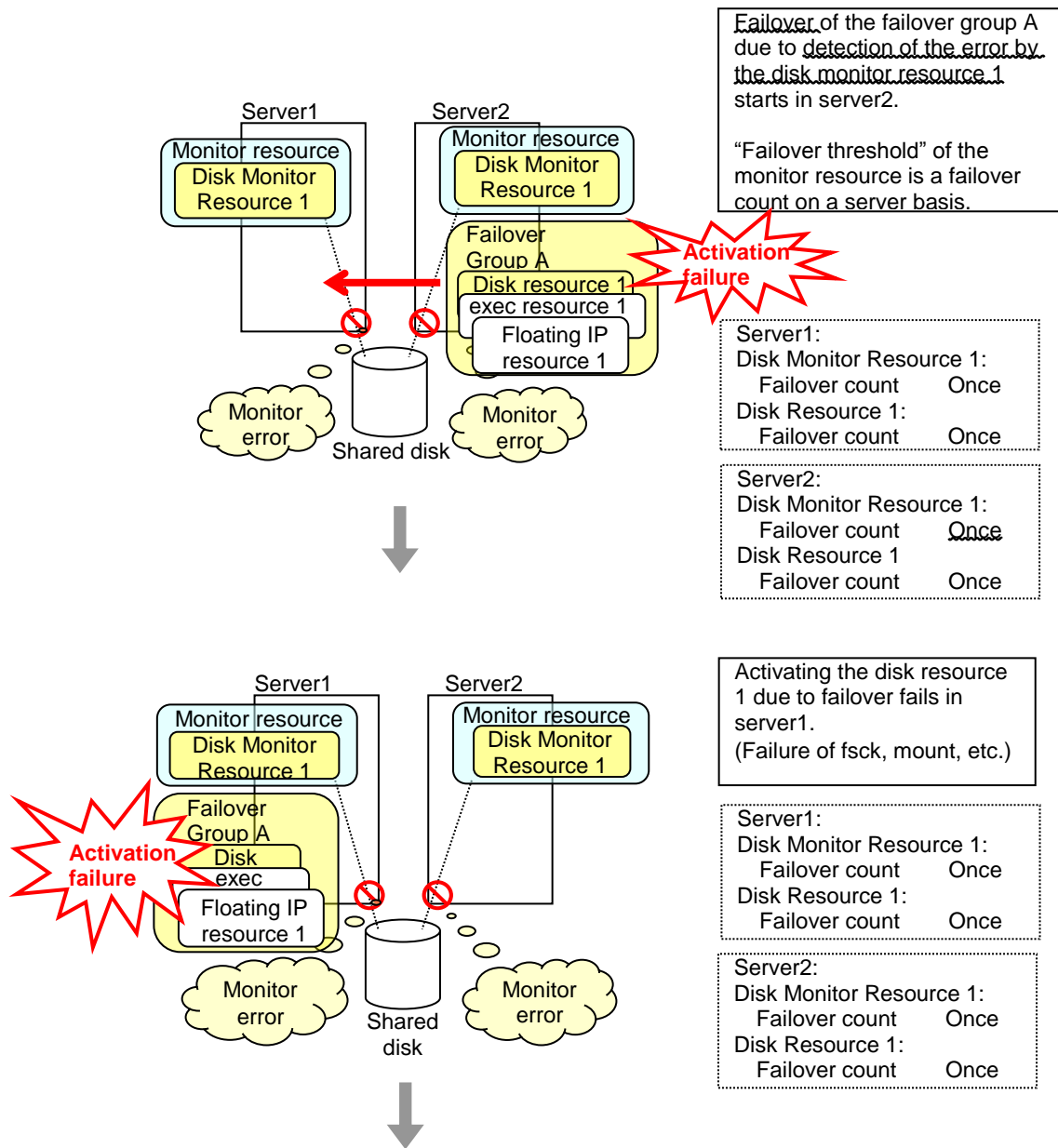

The final action is executed in server1 as is the case in server2 because the number of failovers due to failure of activating the disk resource 1 has exceeded the threshold.

However, note that activation ends abnormally without activating the rest of the group resources in the Failover Group A because “No operation (Next resources are not activated)” is selected as the final action.

An error can be detected in deactivation of the disk resource depending on the location of the disk device failure.

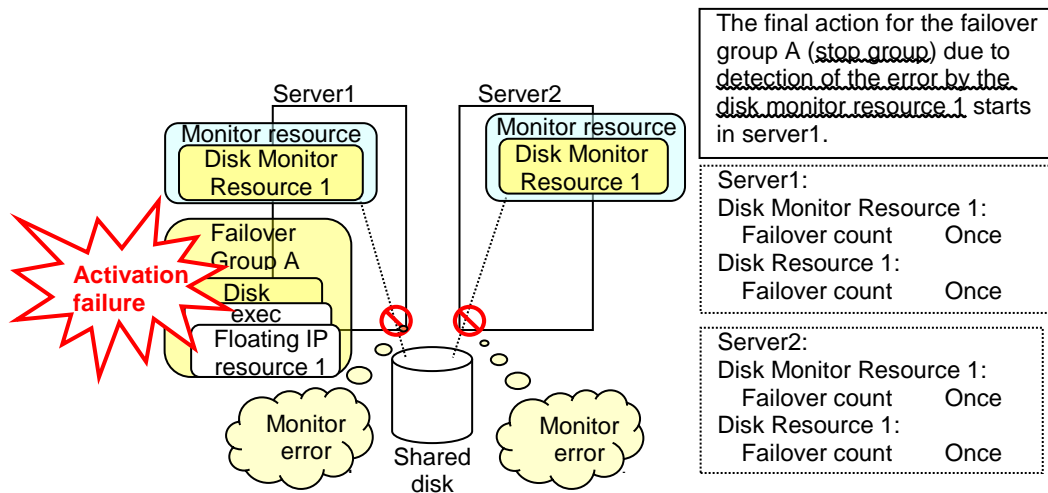

The final action is executed in server1 because the number of failovers due to monitoring error detected by the disk monitor resource 1 has exceeded the threshold.

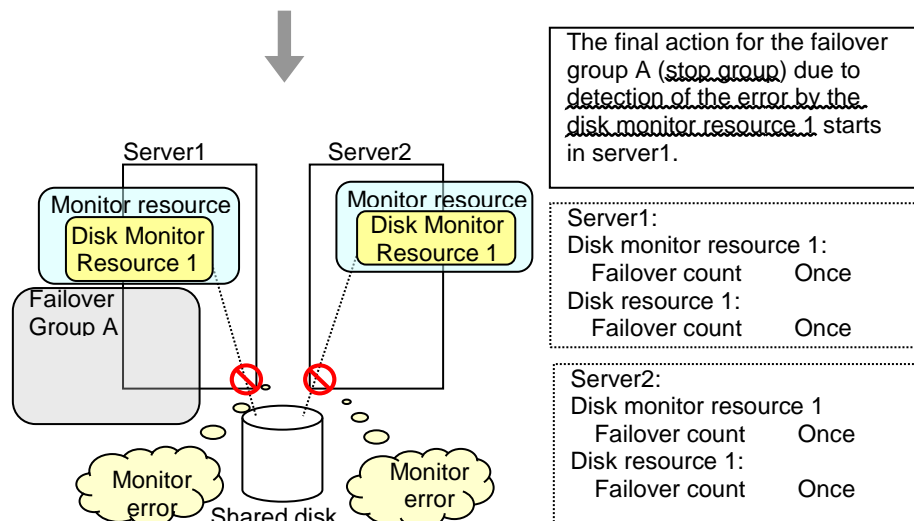

After the Failover Group A is stopped due to the final action executed for the disk monitor resource 1 in server1, nothing will happen even if an error is detected by the disk monitor resource 1.

However, note that the final action for the disk monitor resource 1 is executed in server2 if the Failover Group A is manually activated because the final action for the disk monitor resource 1 is not executed yet.

## Recovery/pre-recovery action script

Upon the detection of a monitor resource error, a recovery script can be configured to run. Alternatively, before the reactivation, failover, or final action of a recovery target, a pre-recovery action script can be configured to run.

The script is a common file.

### Environment variables used in the recovery/pre-recovery action script

EXPRESSCLUSTER sets status information (the recovery action type) in the environment variables upon the execution of the script.

The script allows you to specify the following environment variables as branch conditions according to the operation of the system.

Environment variable	Value of the environment variable	Description
CLP_MONITORNAME ...Monitor resource name	Monitor resource name	Name of the monitor resource in which an error that causes the recovery/pre-recovery action script to run is detected.
CLP_VERSION_FULL ...EXPRESSCLUSTER full version number	EXPRESSCLUSTER full version number	EXPRESSCLUSTER full version number. (Example) 3.3.0-1
CLP_VERSION_MAJOR ...EXPRESSCLUSTER major version	EXPRESSCLUSTER major version	EXPRESSCLUSTER major version (Example) 3
CLP_PATH ...EXPRESSCLUSTER installation path	EXPRESSCLUSTER installation path	Path of EXPRESSCLUSTER installation. (Example) /opt/nec/clusterpro
CLP_OSNAME ...Server OS name	Server OS name	Name of the server OS on which the script is executed. (Example) (1) When the OS name could be acquired: Red Hat Enterprise Linux Server release 6.0 (Santiago) (2) When the OS name could not be acquired: Linux
CLP_OSVER ...Server OS version	Server OS version	Version of the server OS on which the script is executed. (Example) (1) When the OS name could be acquired:6.0 (2) When the OS version could not be acquired: *None



Environment variable	Value of the environment variable	Description
CLP_ACTION ...Recovery action type	RECOVERY	Execution as a recovery script.
	RESTART	Execution before reactivation.
	FAILOVER	Execution before failover.
	FINALACTION	Execution before final action.
CLP_RECOVERYCOUNT ...Recovery script execution count	Recovery Script Execution Count	Count for recovery script execution.
CLP_RESTARTCOUNT ...Reactivation count	Reactivation count	Count for reactivation.
CLP_FAILOVERCOUNT ...Failover count	Failover count	Count for failover.

### Writing recovery/pre-recovery action scripts

This section explains the environment variables mentioned above, using a practical scripting example.

**Example of a recovery/pre-recovery action script**

```

#!/bin/sh
# *****
# *           preaction.sh           *
# *****

if [ "$CLP_ACTION" = "RECOVERY" ]
then
    Processing type:
        Recovery
    Execution timing for the processing:
        Recovery action: Recovery script

elif [ "$CLP_ACTION" = "RESTART" ]
then
    Processing type:
        Pre-reactivation processing
    Execution timing for the processing:
        Recovery action: Reactivation

elif [ "$CLP_ACTION" = "FAILOVER" ]
then
    Processing type:
        Recovery
    Execution timing for the processing:
        Recovery action: Failover

elif [ "$CLP_ACTION" = "FINALACTION" ]
then
    Processing type:
        Recovery
    Execution timing for the processing:
        Recovery action: Final action

fi
exit 0

```

Branched according to the environment variables for the cause of execution of the script.

*Processing type:*  
 Recovery  
*Execution timing for the processing:*  
 Recovery action: Recovery script

*Processing type:*  
 Pre-reactivation processing  
*Execution timing for the processing:*  
 Recovery action: Reactivation

*Processing type:*  
 Recovery  
*Execution timing for the processing:*  
 Recovery action: Failover

*Processing type:*  
 Recovery  
*Execution timing for the processing:*  
 Recovery action: Final action

### Tips for recovery/pre-recovery action script coding

Pay careful attention to the following points when coding the script.

- ◆ When the script contains a command that requires a long time to run, log the end of execution of that command. The logged information can be used to identify the nature of the error if a problem occurs. `clplogcmd` is used to log the information.
- ◆ How to use `clplogcmd` in the script  
With `clplogcmd`, messages can be output to WebManager alert view or OS syslog. For `clplogcmd`, see “Outputting messages (`clplogcmd` command)” in Chapter 3, “EXPRESSCLUSTER command reference” in this guide.

(Ex. : Scripting image)

```
clplogcmd -m "recoverystart.."
recoverystart
clplogcmd -m "OK"
```

### Note on the recovery/pre-recovery action script

- ◆ Stack size for commands and applications activated from the script

The recovery/pre-recovery action script runs with the stack size configured to 2 MB. If the script has a command or application that requires a stack size of 2 MB or more to run, a stack overflow occurs.

If a stack overflow error occurs, adjust the stack size before the command or application is activated.

- ◆ Condition that a pre-recovery action script is executed as the final action

A pre-recovery action script is executed as the final action before the final action due to a monitor error detected by a monitor. Even if **No operation** is set as the final action, a pre-recovery action script is executed.

If the final action is not executed because the maximum restart count has reached the upper limit or by the function to suppress the monitor resource recovery action or the function to suppress the final action when all other servers are being stopped, a pre-recovery action script is not executed.

## Delay warning of monitor resources

When a server is heavily loaded, due to a reason such as applications running concurrently, a monitor resource may detect a monitoring timeout. It is possible to have settings to issue an alert at the time when polling time (the actual elapsed time) reaches a certain percentages of the monitoring time before a timeout is detected.

The following figure shows timeline until a delay warning of the monitor resource is used.

In this example, the monitoring timeout is set to 60 seconds and the delay warning rate is set to 80%, which is the default value.

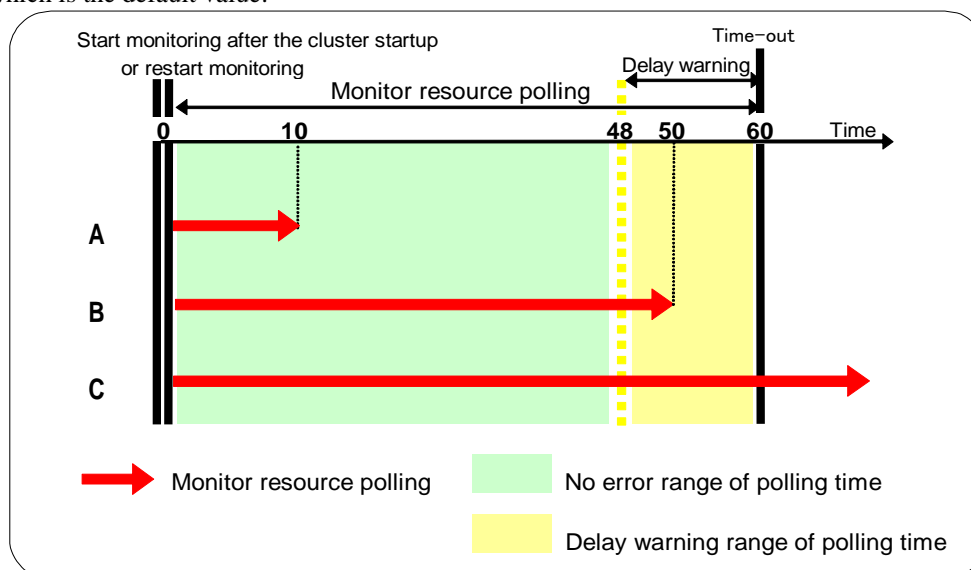

- A. The polling time of monitoring is 10 seconds. The target of the monitor resource is in normal status. In this case, no alert is used.
- B. The polling time of monitoring is 50 seconds and the delay of monitoring is detected during this time. The target of the monitor resource is in the normal status. In this case, an alert is used because the delay warning rate has exceeded 80%.
- C. The polling time of monitoring has exceeded 60 seconds of the monitoring timeout and the delay of monitoring is detected. The target of the monitor resource has a problem. In this case, no alert is used.

If the delay warning rate is set to 0 or 100:

- ◆ When 0 is set to the delay monitoring rate  
An alert for the delay warning is used at every monitoring.  
By using this feature, the polling time for the monitor resource can be calculated at the time the server is heavily loaded, which will allow you to determine the time for monitoring timeout of a monitor resource.
- ◆ When 100 is set to the delay monitoring rate  
The delay warning will not be used.  
Alert for the delay warning is used for the heartbeat resources as well.  
For the user-mode monitor resource, the same delay monitoring rate as for the monitor resource is used.

---

### Note:

Be sure not to set a low value, such as 0%, except for a test operation.

---

## Waiting for monitor resource to start monitoring

“Wait Time to Start Monitoring” refers to start monitoring after the period of time specified as the waiting time elapses.

The following describes how monitoring differs when the wait time to start monitoring is set to 0 second and 30 seconds.

Configuration of monitor resource

<Monitor>

Interval	30 sec
Timeout	60 sec
Retry Count	0 times
Wait Time to Start Monitoring	0 sec / 30 sec

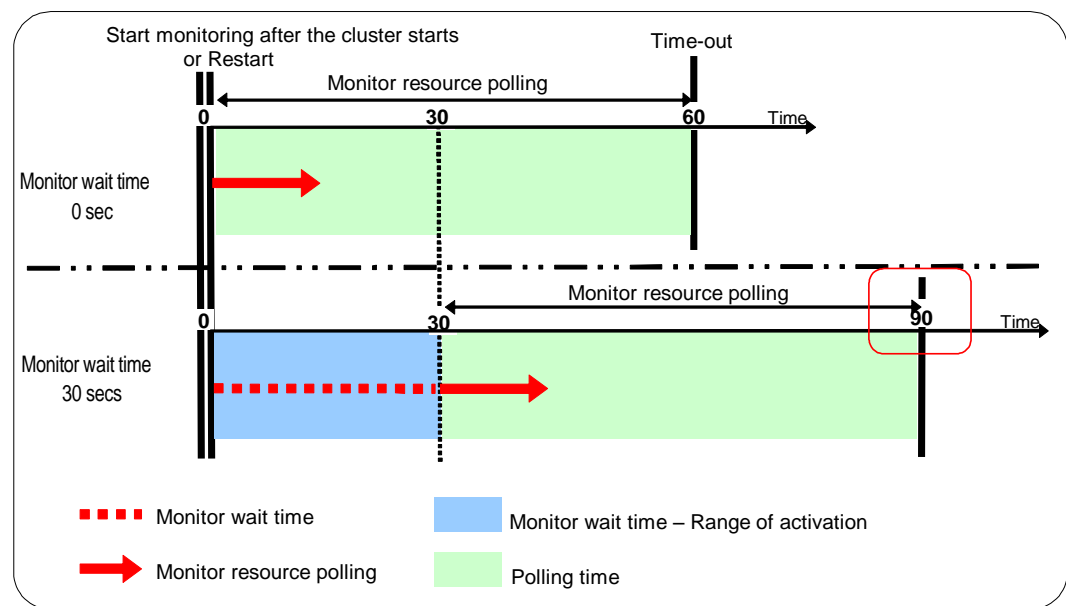

### Note:

Monitoring will start after the time specified to wait for start monitoring has elapsed even when the monitor resource is suspended and/or resumed by using the monitoring control commands.

The wait time to start monitoring is used when there is a possibility for monitoring to be terminated right after the start of monitoring due to incorrect application settings, such as the exec resource monitored by PID monitor resource, and when they cannot be recovered by reactivation.

For example, when the monitor wait time is set to 0 (zero), recovery may be endlessly repeated. See the example below:

Configuration of PID Monitor resource

<Monitor>

Interval	5 sec
Timeout	60 sec
Retry Count	0 times
Wait Time to Start Monitoring	0 sec (default)

<Error Detection>

Recover Target	exec1
Reactivation Threshold	1
Failover Threshold	1
Final Action	Stop Group

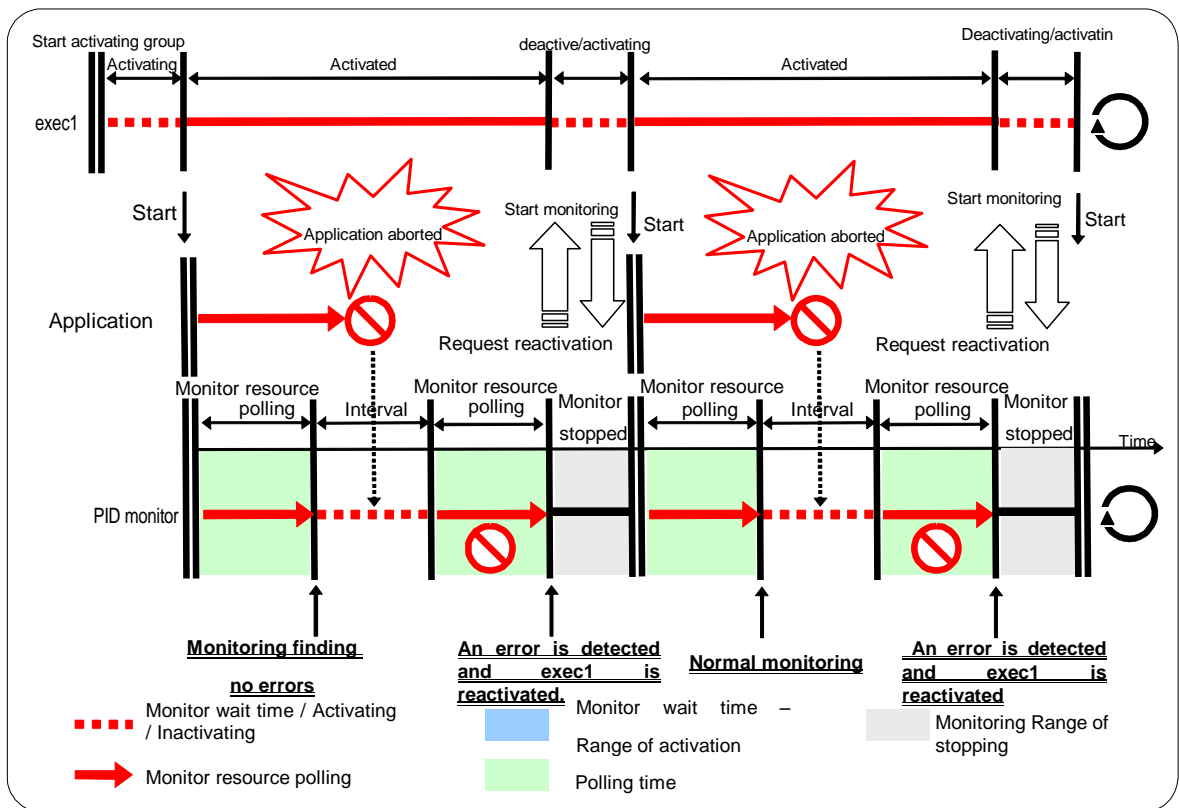

The reason why recovery action is endlessly repeated is because the initial monitor resource polling has terminated successfully. The current count of recoveries the monitor resource has executed is reset when the status of the monitor resource becomes normal (finds no error in the monitor target). Because of this, the current count is always reset to 0 and reactivation for recovery is endlessly repeated.

You can prevent this problem by setting the wait time to start monitoring. By default, 60 seconds is set as the wait time from the application startup to the end.

Configuration of PID monitor resource

```

<Monitor>
Interval                5 sec
Timeout                 60 sec
Retry Count             0 times
Wait Time to Start Monitoring 60 sec

<Error Detection>
Recover Target          exec1
Reactivation Threshold  1 time
Failover Threshold     1 time
Final Action            Stop Group
    
```

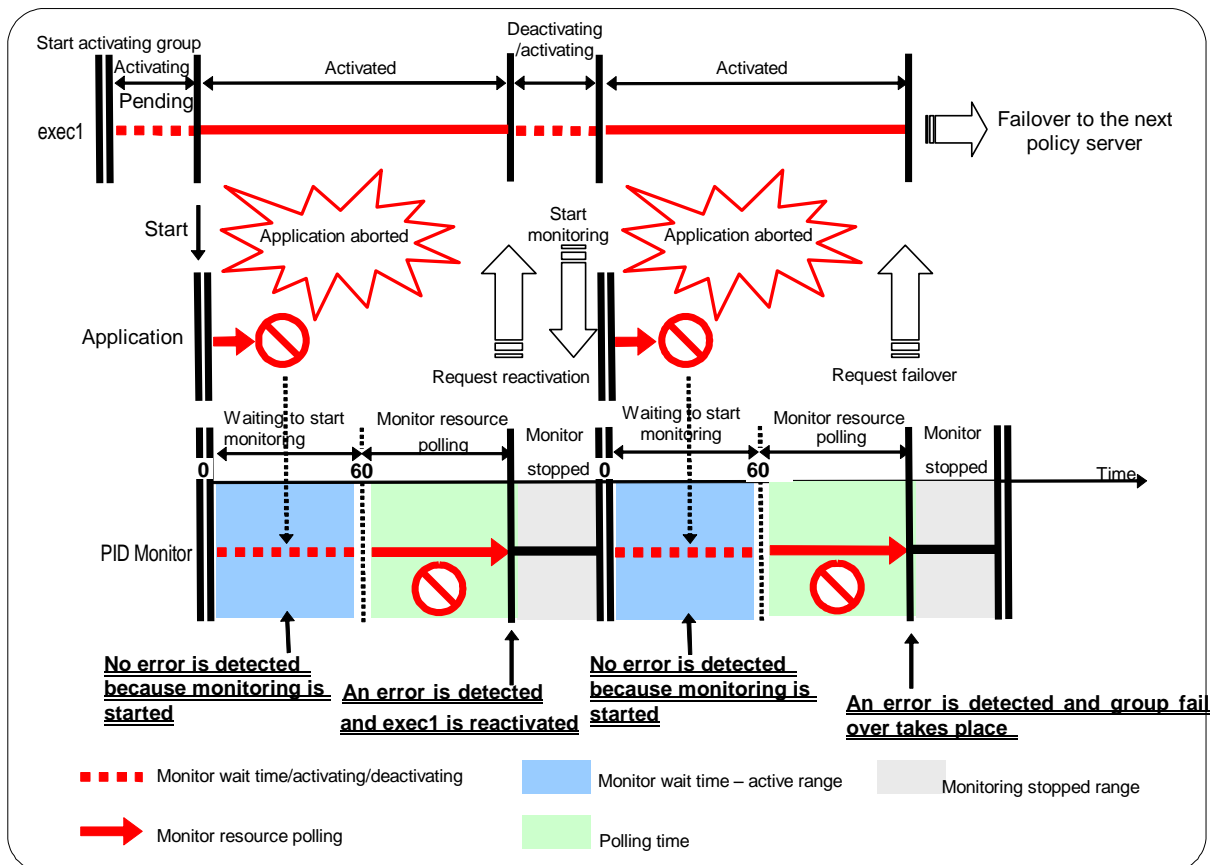

If the application is abnormally terminated in the destination server of the group failover, the group stops as the final action.

## Limiting the number of reboots when an error is detected by the monitor resource

When **Stop cluster service and shutdown OS** or **Stop cluster service and reboot OS** is selected as a final action to be taken when an error is detected by the monitor resource, the number of shutdowns or reboots can be limited.

---

**Note:**

The maximum reboot count is on a server basis because the number of reboots is recorded on a server basis.

The number of reboots caused by a final action in detection of error in group activation/deactivation and the number of reboots caused by a final action in detection of error by a monitor resource are recorded separately.

If the time to reset the maximum reboot count is set to zero (0), the number of reboots will not be reset.

---

The following is an example of the process when the number of reboots is limited.

As a final action, **Stop cluster daemon and reboot OS** is executed once because the maximum reboot count is set to one (1).

When the monitor resource finds no error in its target for 10 minutes after reboot following cluster shutdown, the number of reboots is reset because the time to reset the maximum reboot count is set to 10 minutes.

Examples of behavior when the following values are set.

Configuration

<Monitor>

Interval	60 sec
Timeout	120 sec
Retry Count	3 times

<Error detection>

Recovery Target	Failover Group A
Reactivation Threshold	0 times
Failover Threshold	0 times
Final Action	Stop cluster daemon and reboot OS

<Reboot count limit >

Maximum reboot count	1 time
----------------------	--------

Time to reset the maximum reboot count 10 minutes



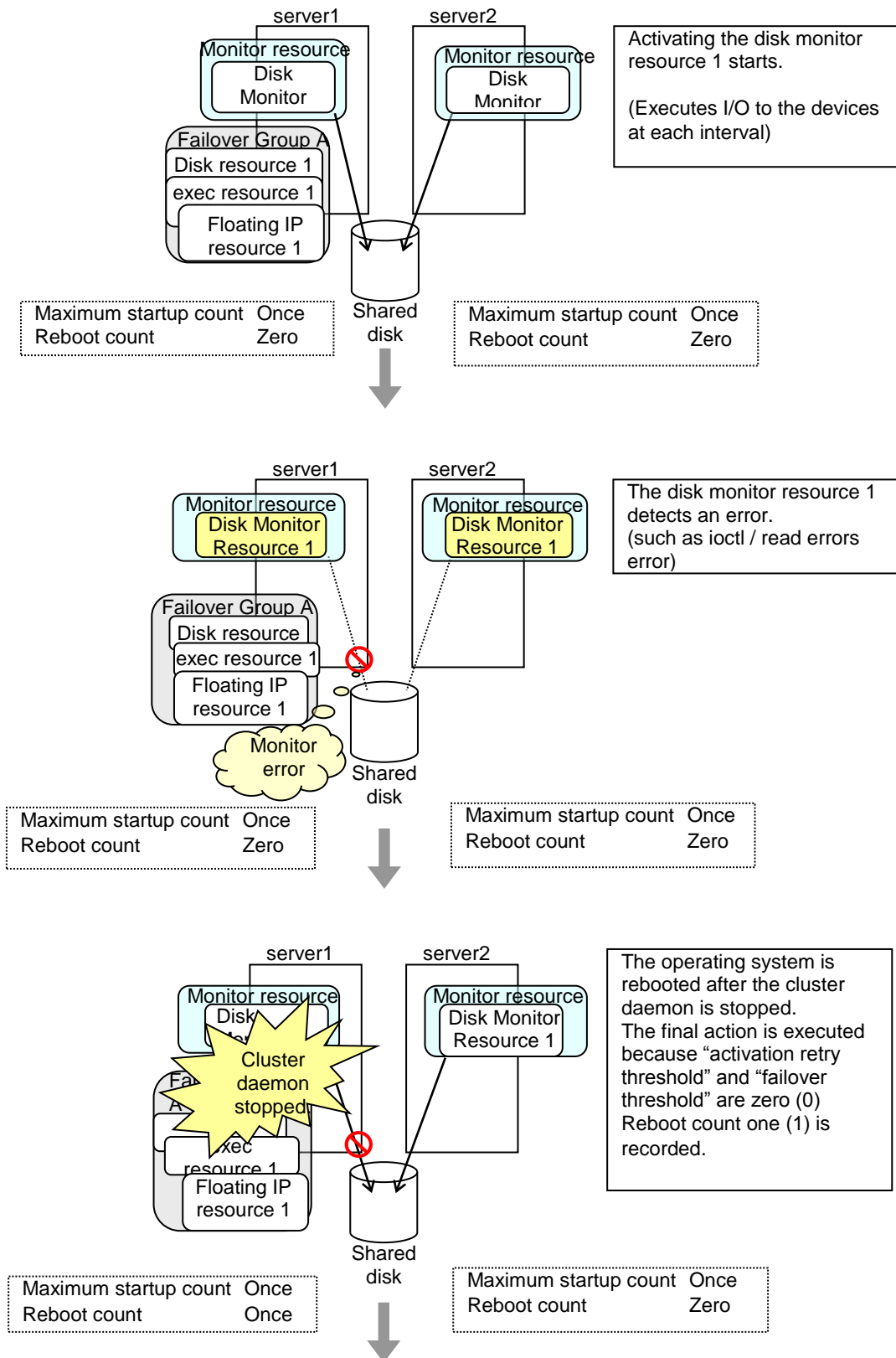

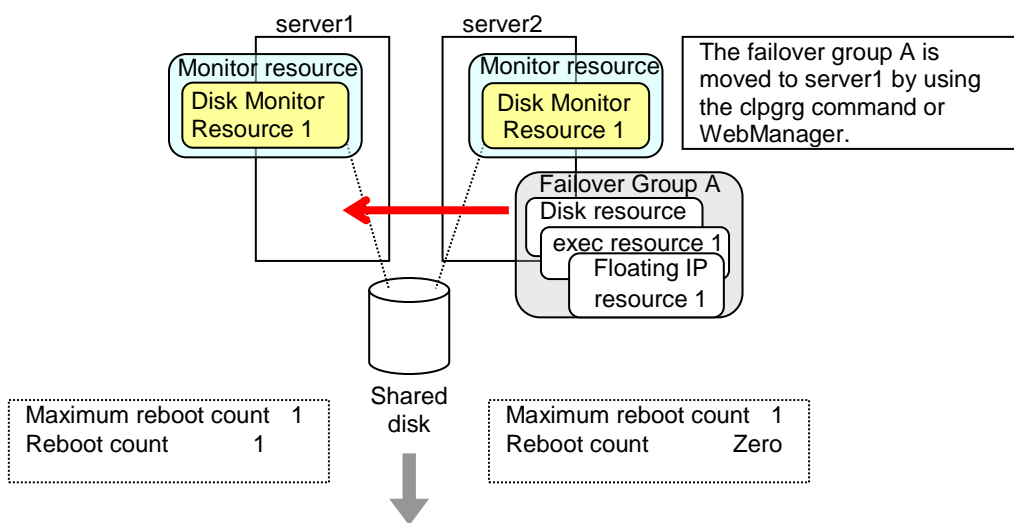
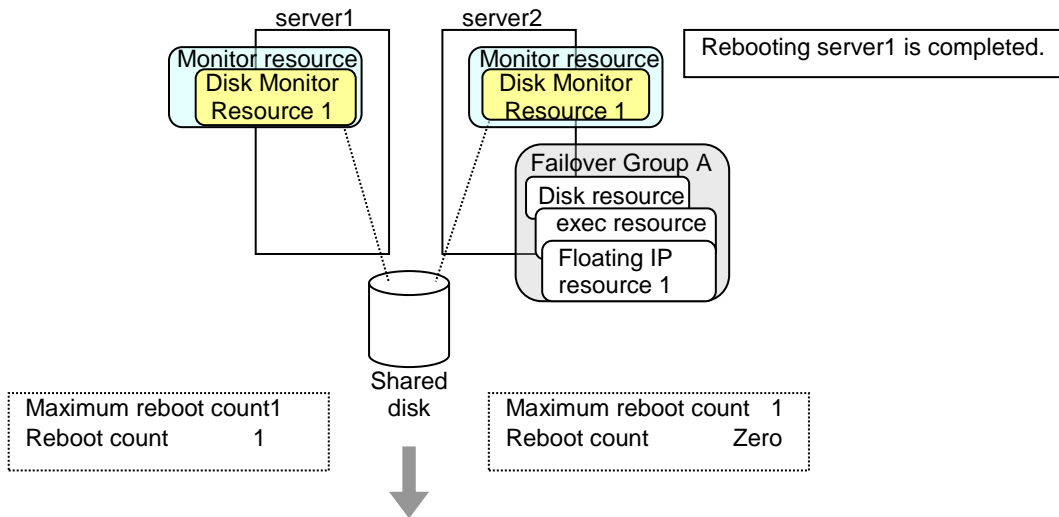
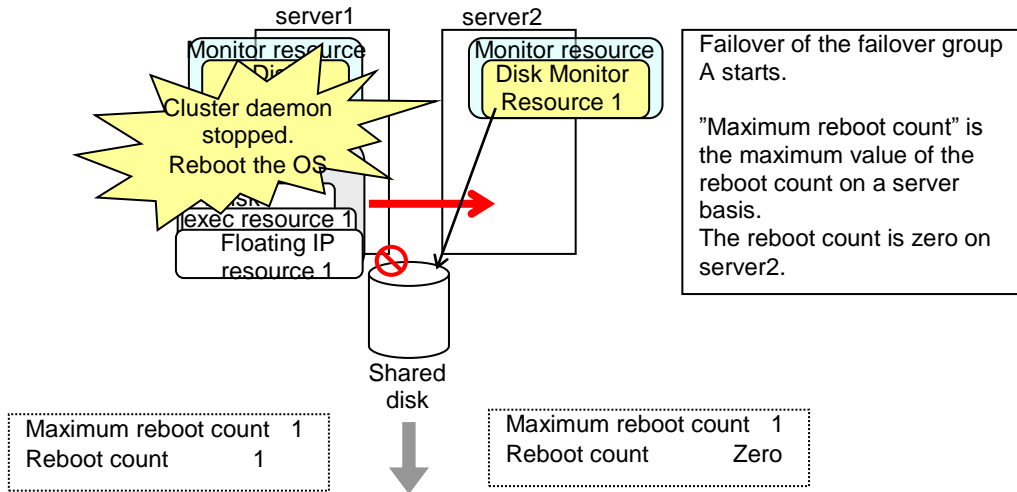

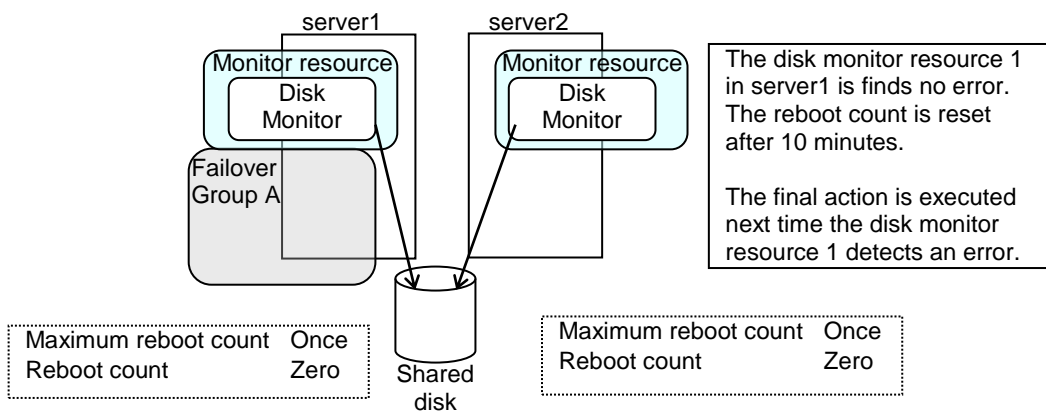
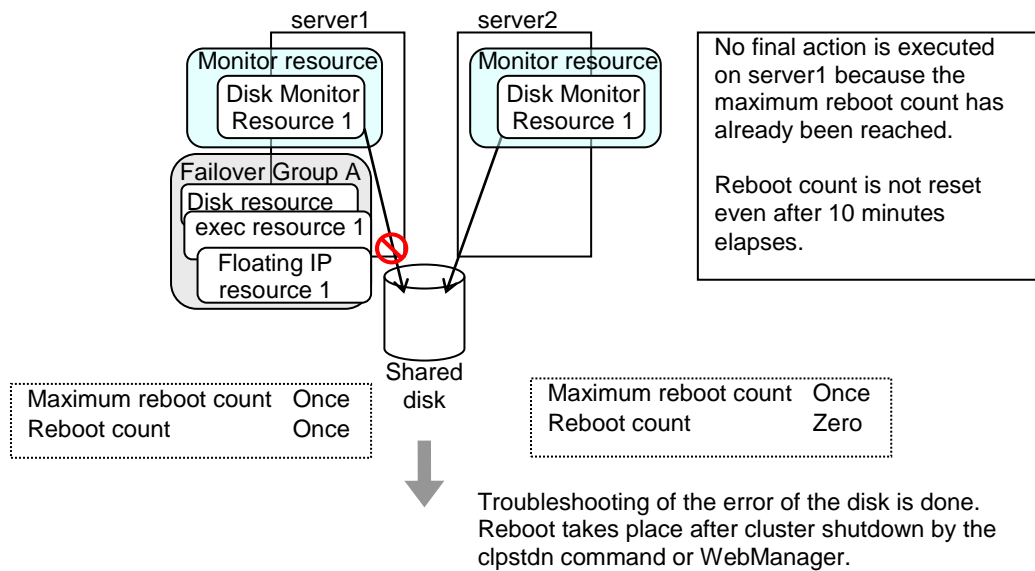
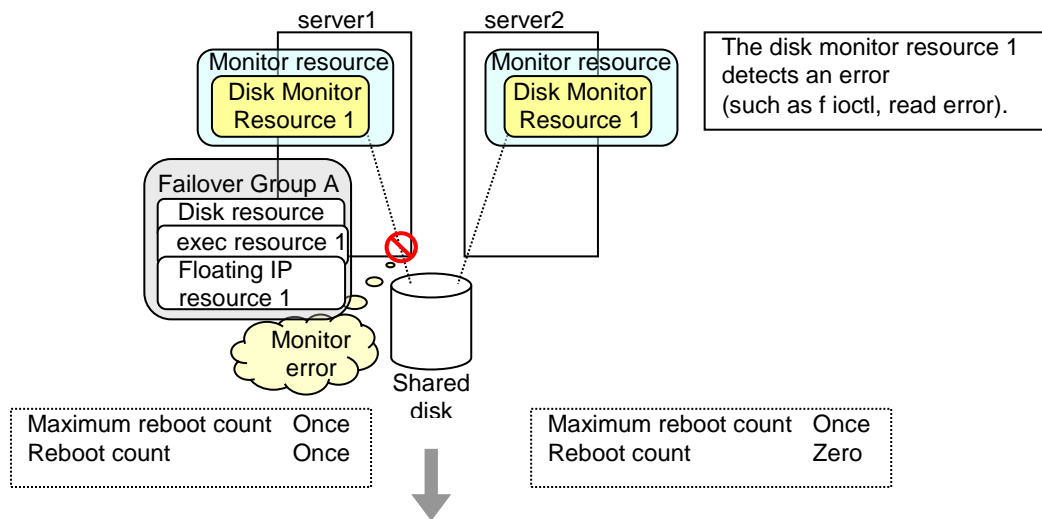

## Monitor priority of the monitor resources

To assign a higher priority for monitor resources to monitor when the operating system is heavily loaded, the nice value can be set.

- ◆ The nice value can be specified through minus 19 (low priority) to plus 20 (high priority). Detection of the monitor timeout can be controlled by setting a higher priority to the nice value.

## Changing the name of a monitor resource

- In the tree view shown on the left pane of the Builder, click the **Monitors** icon. In the table view shown on the right side of the screen, right-click the icon of the monitor resource whose name you want to change, and click **Rename Monitor Resource**.
- Enter a new name in the **Change Monitor Resource Name** dialog box.

## Displaying and changing the comment of a monitor resource (Monitor resource properties)

1. In the tree view shown on the left pane of the Builder, right-click the **Monitors** icon. In the table view shown on the right side of the screen, right-click the icon of the monitor resource whose comment you want to change, and then click **Properties. Group Properties** dialog box is displayed.
2. On the **Info** tab, the group resources name and comment are shown. Enter a new comment (within 127 bytes).

---

**Note:**

You cannot change the group resource name on the **Info** tab. To change the group name, right-click the **Monitors** icon as described in the step 1 above. Click **Rename Monitor Resource** and enter a new name.

---

## Displaying and changing the settings of a monitor resource (Common to monitor resources)

1. In the tree view shown on the left pane of the Builder, click the **Monitors** icon.
2. The list of monitor resources is shown in the table view on the right side of the screen. Right-click the name of the monitor resource whose settings you want to change. Click **Properties**, and then click the **Monitor(Common)** tab.
3. On the **Monitor(Common)** tab, you can see and/or change the settings of monitor resource by following the description below.

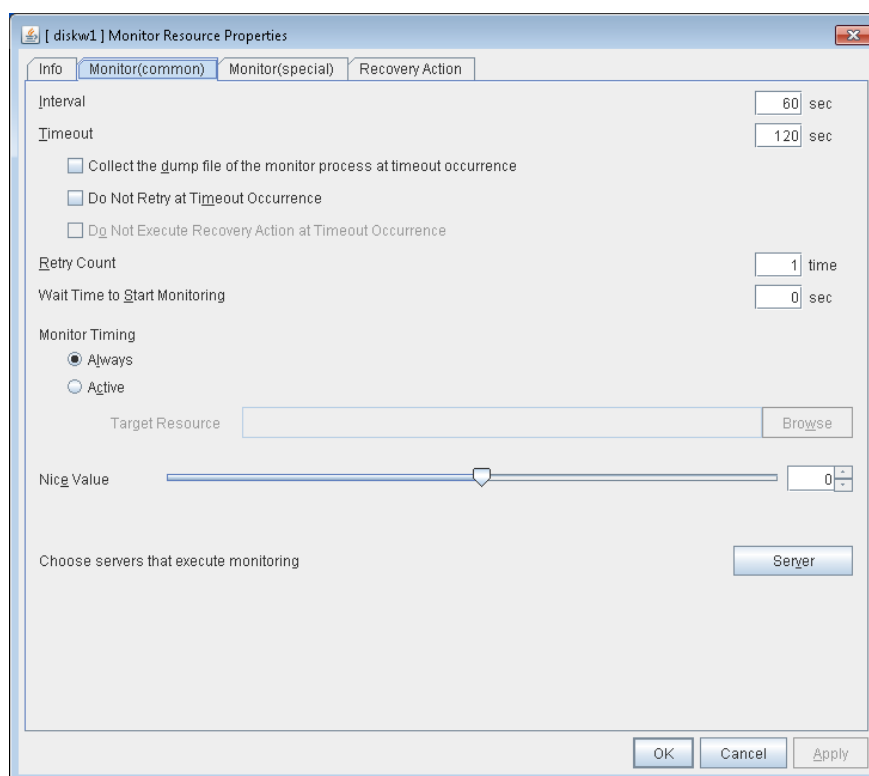

**Interval** 1 to 999

Specify the interval to check the status of monitor target.

**Timeout** 5 to 999<sup>4</sup>

When the normal status cannot be detected within the time specified here, the status is determined to be error.

### Collect the dump file of the monitor process at timeout occurrence

In case that this function is enabled, the dump information of the timed out monitor resource is collected when the monitor resource times out. The collected dump information is written to the `/opt/nec/clusterpro/work/rm/"monitor_resource_name"/errinfo.cur` folder. When dump is performed more than once, the existing folders are renamed `errinfo.1`, `errinfo.2`, and so on. Dump information is collected up to 5 times.

### Do Not Retry at Timeout Occurrence

<sup>4</sup> When ipmi is set as a monitoring method for the user-mode monitor resource, 255 or less should be specified.  
Section II Resource details

When this function is enabled, recovery action is executed immediately if a monitor resource timeout occurs.

**Do Not Execute Recovery Action at Timeout Occurrence**

When this function is enabled, recovery action is not executed if a monitor resource timeout occurs.

This can be set only when the Do Not Retry at Timeout Occurrence function is enabled..

---

**Notes:**

For the following monitor resources, the Do Not Retry at Timeout Occurrence and Do Not Execute Recovery Action at Timeout Occurrence functions cannot be set.

- Message receive monitor resource
  - Custom monitor resource (whose monitor type is **Asynchronous**)
- 

**Retry Count** 0 to 999

Specify how many times an error should be detected in a row after the first one is detected before the status is determined as error. If this is set to zero (0), the status is determined as error at the first detection of an error.

**Wait Time to Start Monitoring** 0 to 9999

Set the wait time to start monitoring.

---

**Notes:**

If timeout of monitor resource is longer than "Wait Time to start Monitoring", the value of the timeout will be used for "Wait Time to Start Monitoring" for following monitor resources.

- Dynamic DNS monitor resource
  - Message receive monitor resource
  - Custom monitor resource (whose monitor type is **Asynchronous**)
  - Virtual IP monitor resource
  - BMC monitor resource
  - DB2 Monitor Resource
  - System Monitor Resource
  - JVM Monitor Resource
  - MySQL Monitor Resource
  - Oracle Monitor Resource
  - Oracle Clusterware Synchronization Management Monitor Resource
  - PostgreSQL Monitor Resource
  - Process Name Monitor Resource
  - Sybase Monitor Resource
- 

**Monitor Timing**

Set the monitoring timing. Select the timing from:

- ◆ Always:  
Monitoring is performed all the time.
- ◆ Active:  
Monitoring is not started until the specified resource is activated.

### Target Resource

The resource which will be monitored when activated is shown.

### Browse

Click this button to open the dialog box to select the target resource. The group names and resource names that are registered in the LocalServer and cluster are shown in a tree view. Select the target resource and click **OK**.

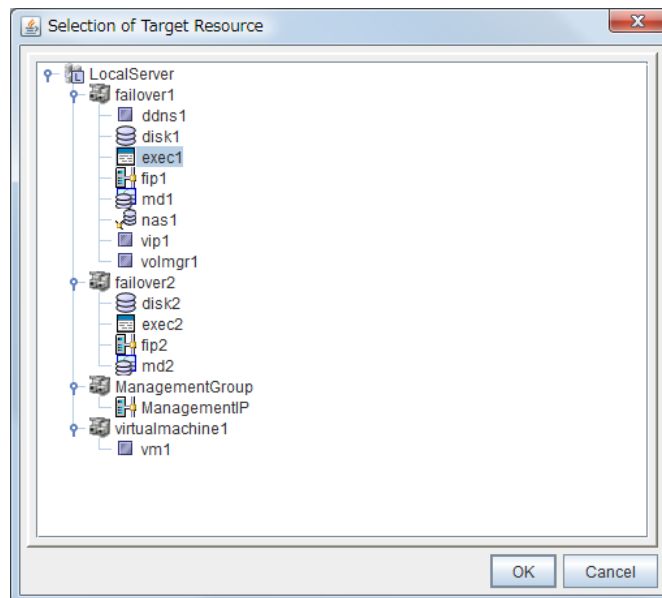

### Nice Value

Set the nice value of a process.

### Choose servers that execute monitoring

Choose the servers that execute monitoring.

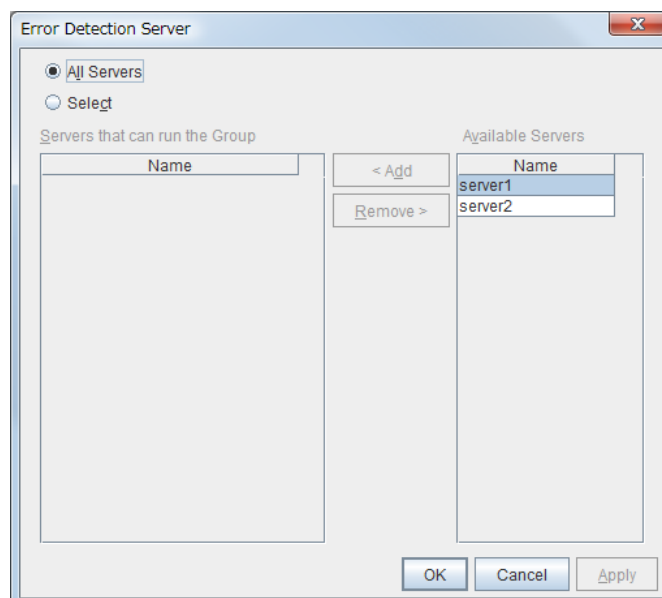

### All Servers

All servers monitor the resources.

### Select

Servers registered in **Available Servers** monitor the resources. One or more servers need to be set to **Available Servers**.

- ◆ **Add**  
Click this button to add a server selected in Available Servers to Servers that can run the Group.
- ◆ **Remove**  
Delete a server selected from Servers that can run the Group.

## Displaying and changing the settings of the time when an error is detected by a monitor resource (Common to monitor resources)

1. In the tree view shown on the left pane of the Builder, click the icon of the monitor resource.
2. The list of group resources is shown in the table view on the right side of the screen. Right-click the name of the monitor resource whose settings you want to change or see. Click **Properties**, and then click the **Recovery Action** tab.
3. On the **Recovery Action** tab, display and/or change the monitor settings by following the description below.

In this dialog box, the recovery target and an action to be taken at the time when an error is detected can be configured. By setting this, it allows failover of the group, restart of the resource and cluster when an error is detected. However, recovery will not occur if the recovery target is not activated.

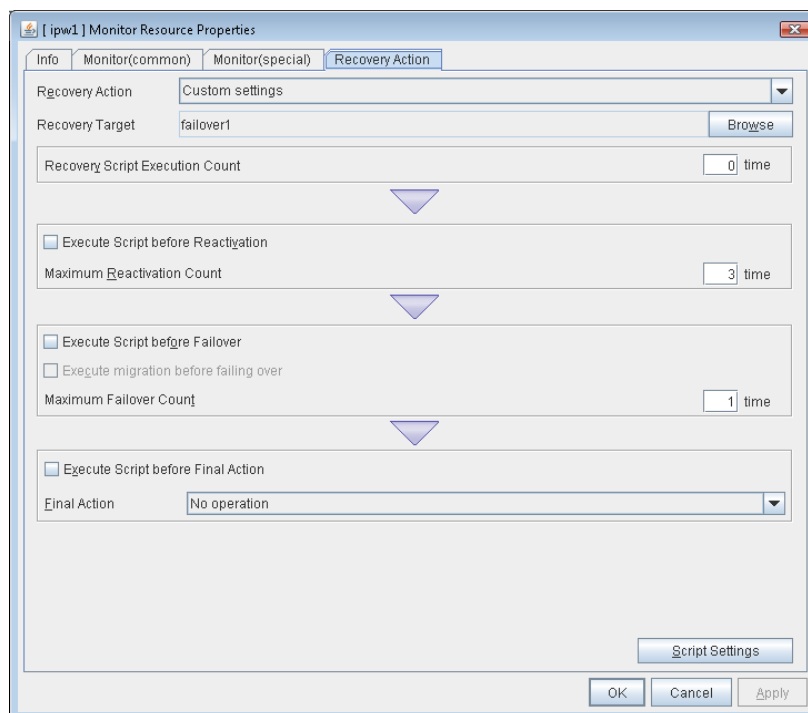

### Recovery Action

Select a recovery action when detecting an error.

- ◆ **Executing failover the recovery target**  
When detecting a monitor error, execute failover to the group to which the groups or group resources selected as the recovery target belong.



- ◆ **Restart the recovery target, and if there is no effect with restart, the failover**  
Reactivate groups or group resources selected as the recovery target. If the reactivation fails, or the same error is detected after the reactivation, then execute failover.
- ◆ **Restart the recovery target**  
Reactivate the selected group or group resource as the recovery target.
- ◆ **Execute only the final action**  
Execute the selected action as the final action.
- ◆ **Custom setting**  
Execute the recovery script up until the maximum script execution count. If an error is continuously detected after script execution, reactivate the selected group or group resource as the recovery target up until the maximum reactivation count. If reactivation fails or the same error is continuously detected after reactivation, and the count reaches the maximum reactivation count, execute failover for the selected group or group resource as the recovery target, up until the maximum failover count. When failover fails or the same error is continuously detected after failover, and the count reaches the maximum failover count, execute the selected action as the final action.

### Recovery Target

A target is shown, which is to be recovered when it is determined as a resource error.

### Browse

Click this button to open the dialog box in which the target resource can be selected. The LocalServer, All Groups and group names and resource names that are registered in the cluster are shown in a tree view. Select the target resource and click **OK**.

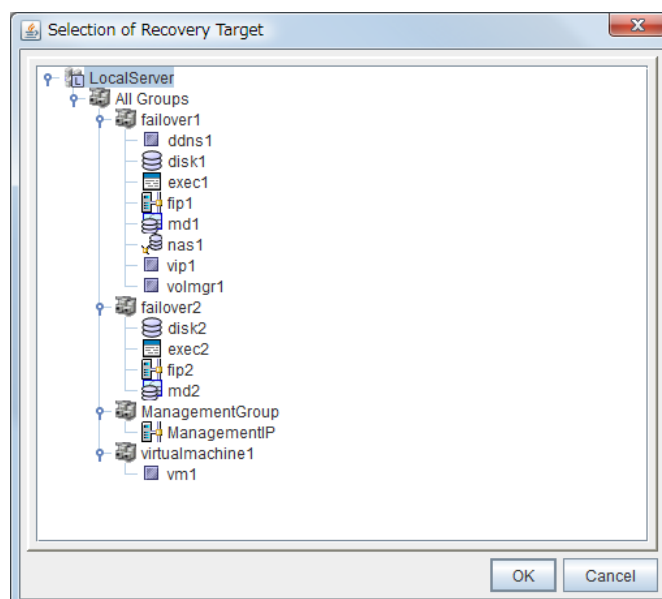

### Recovery Script Execution Count 0 to 99

Specify the number of times to allow execution of the script configured by **Script Settings** when an error is detected. If this is set to zero (0), the script does not run.

### Execute Script before Reactivation

- ◆ When the check box is selected:

A script/command is executed before reactivation. To configure the script/command setting, click **Script Settings**.

- ◆ When the check box is not selected:  
Any script/command is not executed.

**Maximum Reactivation Count** 0 to 99

Specify how many times you allow reactivation when an error is detected. If this is set to zero (0), no reactivation is executed. This is enabled when a group or group resource is selected as a recovery target.

When the group to which dynamic failover or a resource which belongs to that group is set as a recovery target of an IP monitor resource or NIC Link Up/Down monitor resource, reactivating the recovery target fails because a monitor resource registered in the exception list detects an error.

**Execute Script before Failover**

- ◆ When the check box is selected:  
A script/command is executed before failover. To configure the script/command setting, click **Script Settings**.
- ◆ When the check box is not selected:  
Any script/command is not executed.

**Execute migration before failing over**

When the check box is selected, execute migration before executing failover at error detection.

**Maximum Failover Count** 0 to 99

Specify how many times you allow failover after reactivation fails for the number of times set in **Maximum Reactivation Count** when an error is detected. If this is set to zero (0), no failover is executed. This can be settable when selecting "All Groups", a group or a group resource as the recovery target. When "All Groups" is selected, execute failover of all groups running on the server of which the monitor resource has detected errors.

**Execute Script before Final Action**

Select whether script is run or not before executing final action.

- ◆ When the check box is selected:  
A script/command is run before executing final action. To configure the script/command setting, click **Script Settings**.
- ◆ When the check box is not selected:  
Any script/command is not run.

When clicking **Script Settings** of **Execute Script before Final Action**, **Edit Script** dialog box is displayed. Set script or script file, and click **OK**.

## Script Settings

Click here to display the **Edit Script** dialog box. Configure the recovery or pre-recovery action script or commands.

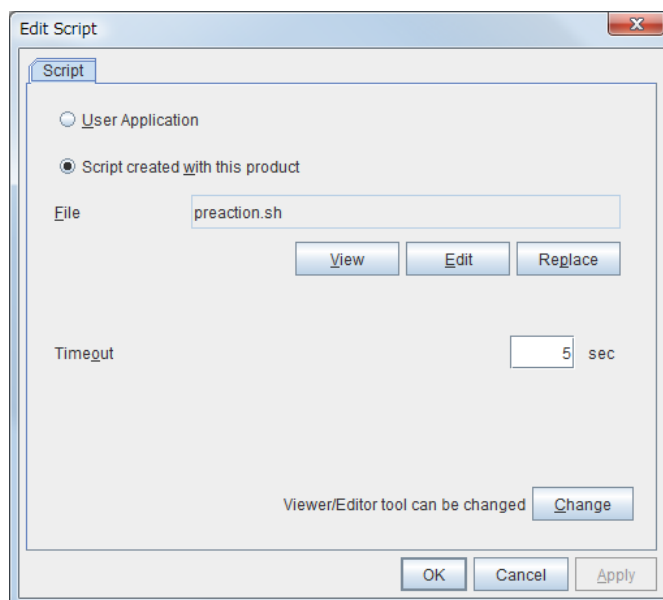

### User Application

Use an executable file (executable shell script file or execution file) on the server as a script. For the file name, specify an absolute path or name of the executable file of the local disk on the server. If there is any blank in the absolute path or the file name, put them in double quotation marks (“”) as follows.

Example:

```
"/tmp/user application/script.sh"
```

Each executable file is not included in the cluster configuration information of the Builder. They must be prepared on each server because they cannot be edited or uploaded by the Builder.

### Script created with this product

Use a script file which is prepared by the Builder as a script. You can edit the script file with the Builder if you need. The script file is included in the cluster configuration information.

### File (Within 1023 bytes)

Specify a script to be executed (executable shell script file or execution file) when you select **User Application**.

**View**

Click here to display the script file with the editor when you select **Script created with this product**. The information edited and stored with the editor is not applied. You cannot display the script file if it is currently displayed or edited.

**Edit**

Click here to edit the script file with the editor when you select **Script created with this product**. Overwrite the script file to apply the change. You cannot edit the script file if it is currently displayed or edited. You cannot modify the name of the script file.

**Replace**

Click here to replace the contents of a script file with the contents of the script file which you selected in the file selection dialog box when you select **Script created with this product**. You cannot replace the script file if it is currently displayed or edited. Select a script file only. Do not select binary files (applications), and so on.

**Timeout** (1 to 9999)

Specify the maximum time to wait for completion of script to be executed. The default value is set as 5.

**Change**

Click here to display the **Change Script Editor** dialog. You can change editor for displaying or editing a script to an arbitrary editor.

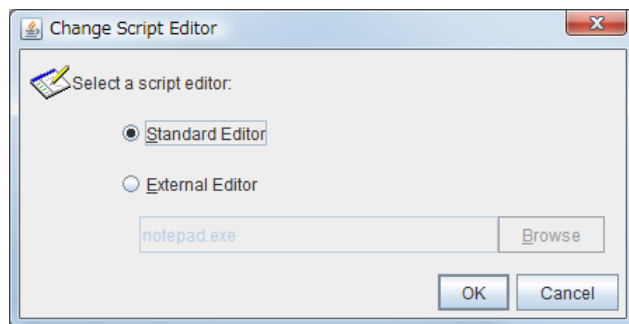
**Standard Editor**

Select this option to use the standard editor for editing scripts.

Linux: vi (vi which is detected by the user's search path)

Windows: Notepad (notepad.exe which is detected by the user's search path)

**External Editor**

Select this option to specify a script editor. Click **Browse** to select an editor.

To specify a CUI-based external editor on Linux, create a shell script.

The following is a sample shell script to run vi:

```
xterm -name clpedit -title " Cluster Builder " -n " Cluster Builder"  
-e vi "$1"
```

**Final Action**

Select a final action to be taken after reactivation fails for the number of times set in **Maximum Reactivation Count**, and failover fails for the number of times set in **Maximum Failover Count** when an error is detected.

Select the final action from the options below:

- ◆ No Operation

No action is taken.

**Note:**

Select **No Operation** only when (1) temporarily canceling the final action, (2) displaying only an alert when an error is detected, and (3) executing the final action by multi target monitor resource.

- ◆ Stop Resource

When a group resource is selected as a recovery target, the selected group resource and group resources that depend on the selected group resource are stopped. This option is disabled when "LocalServer", "All Groups", or a group is selected.

- ◆ Stop Group

When a group is selected as a recovery target, that group is stopped. When a group resource is selected as a recovery target, the group that the group resource belongs is stopped. When "All Groups" is selected, stop all the groups running on the server of which the monitor resource has detected errors.

This option is disabled when "LocalServer" is selected as the recovery target.

- ◆ Stop cluster service

Stops the cluster service of the server that detected an error.

- ◆ Stop cluster service and shutdown OS

Stops the cluster service of the server that detected an error, and then shuts down the OS.

- ◆ Stop cluster service and reboot OS

Stops the cluster service of the server that detected an error, and then reboots the OS.

- ◆ Generate intentionally stop error

Generate stop error intentionally to the server.

- ◆ Sysrq Panic

Performs the sysrq panic.

**Note:**

If performing the sysrq panic fails, the OS is shut down.

- ◆ Keepalive Reset

Resets the OS using the clpkhb or clpka driver.

**Note:**

If resetting keepalive fails, the OS is shut down. Do not select this action on the OS and kernel where the clpkhb and clpka drivers are not supported.

- ◆ Keepalive Panic

Performs the OS panic using the clpkhb or clpka driver.

**Note:**

If performing the keepalive panic fails, the OS is shut down. Do not select this action on the OS and kernel where the clpkhb and clpka drivers are not supported.

---

◆ BMC Reset

Perform hardware reset on the server by using the ipmi command.

---

**Note:**

If resetting BMC fails, the OS is shut down. Do not select this action on the server where the ipmitool or ipmiutil is not installed, or the ipmitool command, the hwreset command or the iredet command does not run.

---

◆ BMC Power Off

Powers off the OS by using the ipmi command. OS shutdown may be performed due to the ACPI settings of the OS.

---

**Note:**

If powering off BMC fails, the OS is shut down. Do not select this action on the server where the ipmitool or ipmiutil is not installed, or the ipmitool command, the hwreset command or the iredet command does not run.

---

◆ BMC Power Cycle

Performs the power cycle (powering on/off) of the server by using the ipmi command. OS shutdown may be performed due to the ACPI settings of the OS.

---

**Note:**

If performing the power cycle of BMC fails, the OS is shut down. Do not select this action on the server where the ipmitool or ipmiutil is not installed, or the ipmitool command, the hwreset command or the iredet command does not run.

---

◆ BMC NMI

Uses the ipmi command to cause NMI occur on the server. Actions after NMI occurrence depend on the OS settings.

---

**Note:**

If BMC NMI fails, the OS shutdown is performed. Do not select this action on the server where the ipmitool or ipmiutil is not installed, or the ipmitool command, the hwreset command or the iredet command does not run.

---

◆ I/O Fencing(High-End Server Option)

Use this on the server in network partition to generate I/O Fencing and NMI.

---

**Note:**

If I/O Fencing(High-End Server Option) fails, the OS shutdown is performed.

---

**Collect Dump at Timeout**

Select whether to enable this function.

Length: Within 4 bytes

Default value: 0 (disabled)

## IPMI command

Final actions **BMC Reset**, **BMC Power Off**, **BMC Power Cycle**, and **BMC NMI** use the ipmitool, hwreset, or ireset command.

When the ipmitool command exists, use the ipmitool command. When the ipmitool command does not exist, use the hwreset command or the ireset command. If the commands are not installed, this function cannot be used.

Command	Option	Description	Final Action
ipmitool	power cycle	Performs the power cycle of the server.	BMC Power Cycle
	power off	Powers off the server.	BMC Power Off
	power reset	Resets the server.	BMC Reset
	power diag	Causes NMI to occur.	BMC NMI

Command	Option	Description	Final Action
hwreset	-c	Performs the power cycle of the server.	BMC Power Cycle
	-d	Powers off the server.	BMC Power Off
ireset	-r	Resets the server.	BMC Reset
	-n	Causes NMI to occur	BMC NMI

### Notes for the final action by ipmi

- ◆ Final Action by IPMI is achieved by associating EXPRESSCLUSTER and the ipmitool command, hwreset command or the ireset command.
- ◆ ipmitool(OpenIPMI-tools) and hwreset or ireset(ipmiutil) are not shipped with EXPRESSCLUSTER. Users are required to install the rpm package by themselves.
- ◆ When executing the final action by the ipmitool command, the ipmi driver needs to be loaded. It is recommended to load the ipmi driver automatically by the chkconfig command at OS startup.

Chassis identify uses the ipmitool command, the alarms command or the ialarms command.

When the ipmitool command exists, use the ipmitool command. When the ipmitool command does not exist, use the alarms command or the ialarms command. If the commands are not installed, this function cannot be used.

Command	Option	Overview
ipmitool	chassis identify <interval>	Chassis identify lamp blink on and off for the period(in seconds) specified by interval.

Command	Option	Overview
hwreset ireset	-i<interval>	Chassis identify lamp blink on and off for the period(in seconds) specified by interval.

### Notes for chassis identify by ipmi

Chassis identify by ipmi is actualized by combining EXPRESSCLUSTER and the ipmitool command, the alarms command or ialarms command.

ipmitool(OpenIPMI-tools) and alarms or ialarms(ipmiutil) are not shipped with EXPRESSCLUSTER. Users are required to install the rpm package by themselves.

### Notes for ipmi

- ◆ When ipmiutil is used, the following kernel module warning log is recorded on the syslog many times.

```
modprobe: modprobe: Can't locate module char-major-10-173
```

To prevent this log records, rename /dev/ipmikcs

- ◆ As of May 1, 2010, you can download ipmiutil by visiting the website at: <http://ipmiutil.sourceforge.net/>
- ◆ Users are responsible for making decisions and assuming responsibilities. NEC does not support or assume any responsibilities for:
  - Inquires about ipmitool, hwreset, ireset, alarms and ialarms themselves.
  - Tested operation of ipmitool, hwreset, ireset, alarms and ialarms.
  - Malfunction of ipmitool, hwreset, ireset, alarms and ialarms or error caused by such malfunction.
  - Inquiries if ipmitool, hwreset, ireset, alarms and ialarms are supported by servers.



## Setting monitor resources on individual servers

Some setting values of monitor resources can be set for individual servers. For the resources which can be configured on a server basis, the tabs of servers are displayed on the **Monitor(special)** tab.

The following monitor resources can be configured for individual servers.

Monitor Resource Name	Supported Version
Disk monitor resource	3.0.0-1 or later
IP monitor resource	3.0.0-1 or later
NIC Link Up/Down monitor resource	3.0.0-1 or later
Message receive monitor resource	3.0.0-1 or later
AWS AZ monitor resource	3.3.0-1 or later

For the parameters that can be configured for individual servers, see the descriptions of parameters on monitor resources. On those parameters, the **Server Individual Setup** icon is displayed.

In the example below, configuring settings for each server on the disk monitor resource is described.

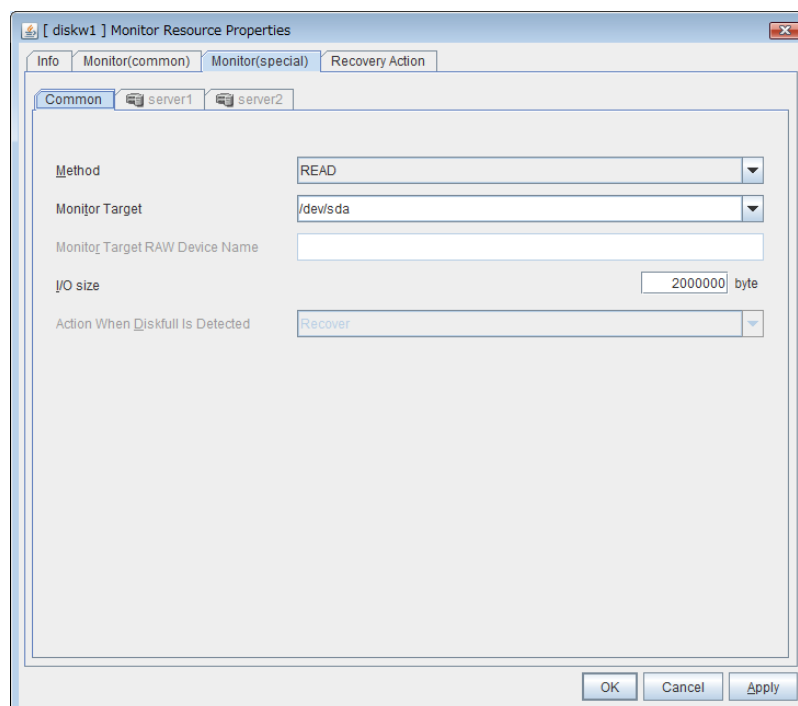

### Server Individual Setup

Parameters that can be configured for individual servers on a disk monitor resource are displayed.

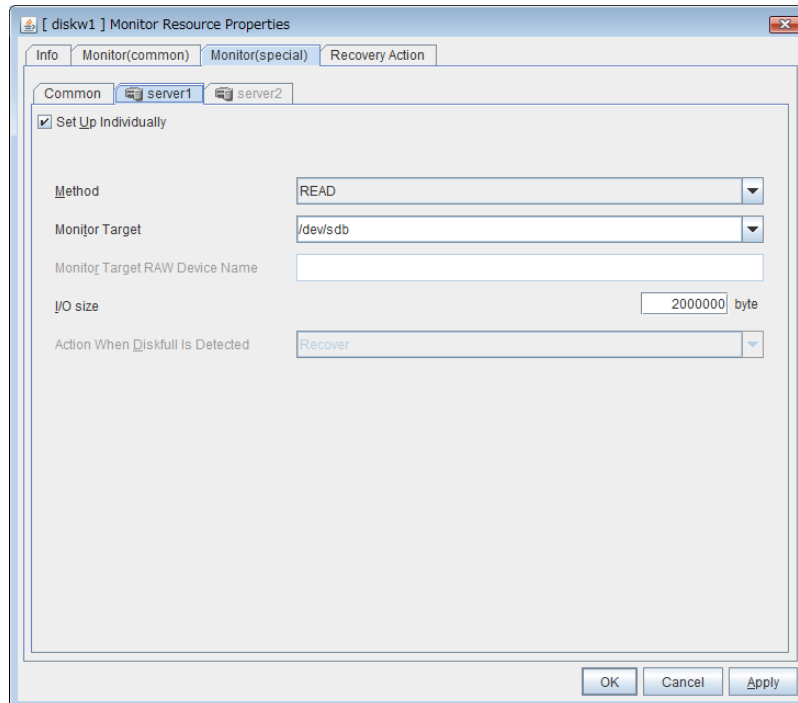

### Set Up Individually

Click the tab of the server on which you want to configure server individual setting, and select this check box. The boxes for parameters that can be configured for individual servers become active. Enter required parameters.

## Common settings for monitor resources of the monitoring option

This section describes the setting procedure for, and cautions related to, monitoring applications by using the monitor resources provided by the Application Server Agent, Database Agent, File Server Agent, Internet Server Agent, Java Resource Agent, and System Resource Agent (hereinafter referred to as “monitoring option”).

### Setting procedure of monitor resources of monitoring option

Follow the steps below to monitor applications by using monitor resources of the monitoring options.

In this example, DB2 monitor resource is used.

1. Create a failover group (for target monitoring application)
2. Add the EXEC resource for target monitoring application startup
3. Perform the test for target monitoring application startup
4. Add DB2 monitor resource for monitoring target monitoring application

The steps are described below.

#### Step 1 Create a failover group (for target monitoring application)

Create a failover group for monitoring the target monitoring application and performing a failover when an error occurs. Add group resources as necessary.

##### Note:

For details on how to create failover groups and add group resources, see Chapter 5 “Creating the cluster configuration data” in the *Installation and Configuration Guide*.

#### Step 2 Add the EXEC resource for starting the target monitoring application

Add the EXEC resource for starting the target monitoring application to the failover group that you have created in Step 1, and edit it to start and finish the target monitoring application by its Start Script or Stop Script. In this guide, this EXEC resource is called `exec 1`.

#### Step 3 Confirmation test for target monitoring application startup

After completing the Steps 1 and 2, check that the monitored application is started normally. Modify the settings to the server, start, stop, move and fail over the group by the WebManager and confirm that those operations are performed normally.

#### Step 4 Add the DB2 monitor resource for starting target monitoring application

Add the DB2 monitor resource for monitoring the target monitoring application. Select **Active** for **Monitor Timing** and specify `exec1` for **Target Resource** on the **Monitor(common)** tab.

##### Note:

For specific information on the monitor resources and settings, see the section on monitoring option monitor resources in Chapter 5 “Monitor resource details” in this guide.

---

**Related Information:**

For details on the monitoring settings common to monitor resources, see “Displaying and changing the settings of a monitor resource (Common to monitor resources) in Chapter 6 “Monitor resource details.”

---

## **Cautions on monitoring option monitor resources**

Cautions for using monitoring option monitor resources are as follows:

- ◆ For monitor resource db2w, ftpw, imap4w, mysqlw, oraclew, oracleasw, pop3w, psqlw, sambaw, sybasew, wasw, wls, otxw, and jraw a password is included as a property entry. This password is saved in plain text on the cluster configuration data file (clp.conf). Thus, it is recommended to create an account dedicated to monitoring other than for application and use it for security reasons.

## Understanding the disk monitor resources

Disk monitor resources monitor disk devices.

It is recommended to use the READ (O\_DIRECT) monitoring method for disks where disk monitor resources cannot be used (TUR method).

### Monitoring by disk monitor resources

Two ways of monitoring are employed by the disk monitor resource: READ and TUR.

- ◆ Notes on TUR:

- You cannot run the Test Unit Ready and the SG\_IO command of SCSI on a disk or disk interface (HBA) that does not support it. Even if your hardware supports this command, consult the driver specifications because the driver may not support it.
- ioctl may be incorrectly executed for an LVM logical volume (LV) device. Use READ for LV monitoring.
- A TUR method cannot be used for the IDE interface disk.
- In the case of the disk of S-ATA interface, it may be recognized as the IDE interface disk (hd) or as the SCSI interface disk (sd) depending on the type of a disk controller and the distribution to be used. When the disk is recognized as the IDE interface, no TUR methods can be used. If the disk is recognized as the SCSI interface, TUR (genetic) cannot be used but TUR (legacy) can be used.
- Test Unit Ready, compared to Read, burdens OS and disks less.
- In some cases, Test Unit Ready may not be able to detect actual errors in I/O to media.
- In an environment in which the OS kernel is updated (kernel-2.6.18-274.18.1.el5 or later, kernel-2.6.32-220.2.1.el6 or later), you cannot use a partition on the disk by setting it as the target to be monitored.
- Some disk devices may temporarily return Unit Attention at TUR issue, depending on the device status.

The temporary return of Unit Attention does not signify a problem. If the TUR retry count is set to 0, however, the above return is determined to be an error and the disk monitor resource becomes abnormal.

To avoid this meaningless error detection, set the retry count to one or more.

For the TUR monitoring, one of the following is selected:

- ◆ TUR

- ioctl is used by the following steps and the status of the device is determined by the result of the command:  
Run the ioctl (SG\_GET\_VERSION\_NUM) command. The status is determined by the return value of ioctl and the version of SG driver.  
If the ioctl command runs successfully and the version of SG driver is 3.0 or later, execute ioctl TUR (SG\_IO) using the SG driver.  
If the ioctl command fails or the version of SG driver is earlier than 3.0, execute ioctl TUR which is defined as a SCSI command.

- ◆ TUR (legacy)

- Monitoring is performed by using ioctl (Test Unit Ready). Test Unit Ready (TUR) which is defined as a SCSI command is used against the specified device, and the status of the device is determined by the result of the command.

◆ TUR (generic)

Monitoring is executed by using `ioctl TUR (SG_IO)`. `ioctl TUR (SG_IO)` which is defined as a SCSI command is used against the specified device, and the status of the device is determined by the result of the command. Even with a SCSI disk, `SG_IO` may not work successfully depending on the OS or distribution.

The following is the READ monitoring:

◆ READ

- The specified size of the specified device (disk device or partition device) or file is read. Judgment is performed by the size that could be read.
- Dummy Read is for determining if the specified size of data can be read. Validity of the data read is not judged.
- Burden of the load experienced by the OS and disk is proportional to the size of the data on the specified disk to be read
- See “I/O size when READ is selected for disk monitor resources” on page 892 to configure the read size.

The following is the READ (O\_DIRECT) monitoring:

◆ READ (O\_DIRECT)

- A single sector on the specified device (disk device or partition device) or the file are read without using the cache (O\_DIRECT mode), and the results are (the size of the data successfully read) are used to make a judgment.
- Judgment is based on whether or not reading has been performed successfully. Validity of the read data is not judged.

The following describes READ (raw) monitoring:

◆ READ (raw)

- Like the READ (O\_DIRECT) monitoring method, the process to read the specified device is monitored without using the OS cache.
- Whether reading was successful is checked. The validity of read data is not checked.
- When the READ (raw) monitoring method is specified, partitions that have been or will possibly be mounted cannot be monitored. In addition, a whole device (whole disk) that includes partitions that have been or will possibly be mounted cannot be monitored. Allocate a partition dedicated to monitoring and specify it as the disk monitor resource. (Allocate 10 MB or more to the monitoring partition).
- Do not register a raw device that is already registered in the **Disk I/F** list or **Disk Resource** under the server properties. For details on the VxVM volume raw device, see “Notes when creating EXPRESSCLUSTER configuration data Verifying raw device for VxVM” in Chapter 5, “Notes and Restrictions” of the *Getting Started Guide*.
- When monitoring the raw device used by the disk heartbeat by using the READ (raw) monitoring method, specify the raw device for **Monitor Target Raw Device Name in Builder**. Do not fill in **Device Name**.

The following describes READ (VXVM) monitoring:

◆ READ (VXVM)

- Like the READ (O\_DIRECT) monitoring method, the process to read the specified device is monitored without using the OS cache.
- Whether reading was successful is checked. The validity of read data is not checked.
- The READ (VXVM) monitoring method can be used only when the file system of the volume raw device is vxfs.

The following is the WRITE (FILE) monitoring:

- ◆ WRITE (FILE)
- The file of the specified path is created, written, and deleted to be judged. Validity of the written data is not judged.

## I/O size when READ is selected for disk monitor resources

Enter the size of data when READ is selected as a method of monitoring.

- Depending on the shared disk and interfaces in your environment, various caches for reading may be implemented. Because of this, when the specified read size is too small, READ may hit in cache, and may not be able to detect read errors.
- When you specify a READ I/O size, verify that READ can detect I/O errors on the disk with that size by intentionally creating I/O errors.

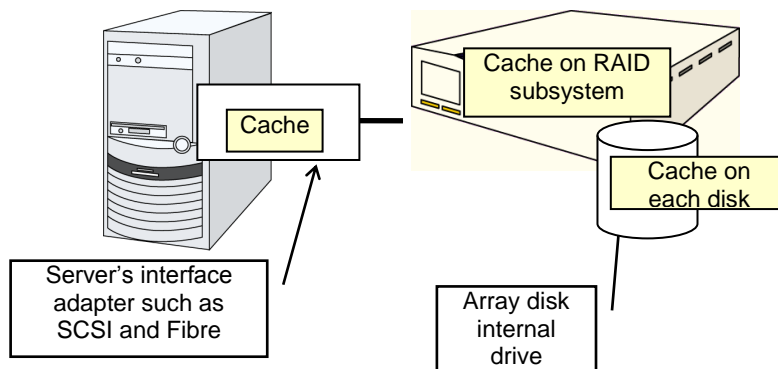

Note: This figure illustrates a typical concept of shared disks. This is not always applicable to array unit universally.



## Setup example when READ (raw) is selected for the disk monitor resource

### Example of setting up disk resources and disk monitoring

- ◆ Disk Resource
- ◆ Disk Monitor Resource (The HDDs installed in both servers are monitored in the READ (raw) mode.)
- ◆ Disk Monitor Resource (The shared disk is monitored in the READ (raw) mode.)

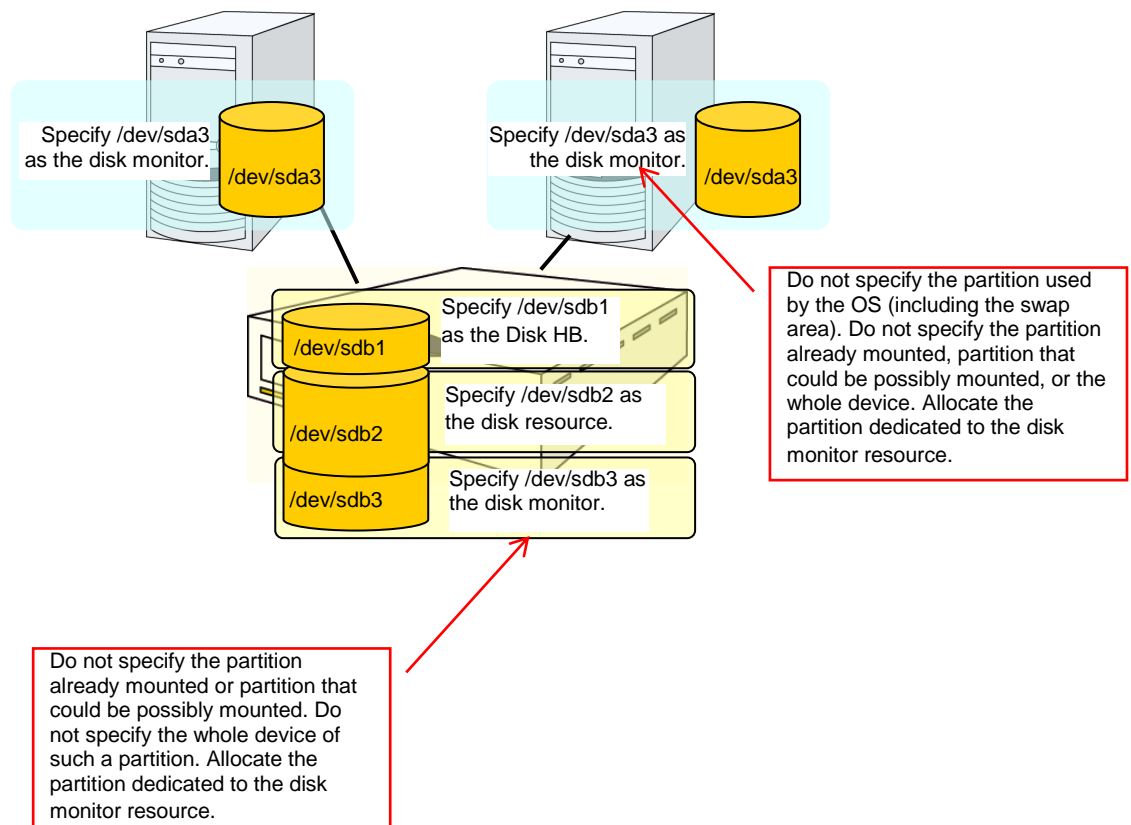

## Displaying and changing the details of disk monitor resources

1. In the tree view shown on the left pane of the Builder, click the **Monitors** icon.
2. The list of group resources is shown in the table view on the right side of the screen. Right-click the name of the disk resource whose settings you want to change. Click **Properties**, and then click the **Monitor(special)** tab.
3. On the **Monitor(special)** tab, you can see and/or change the monitor settings by following the description below.

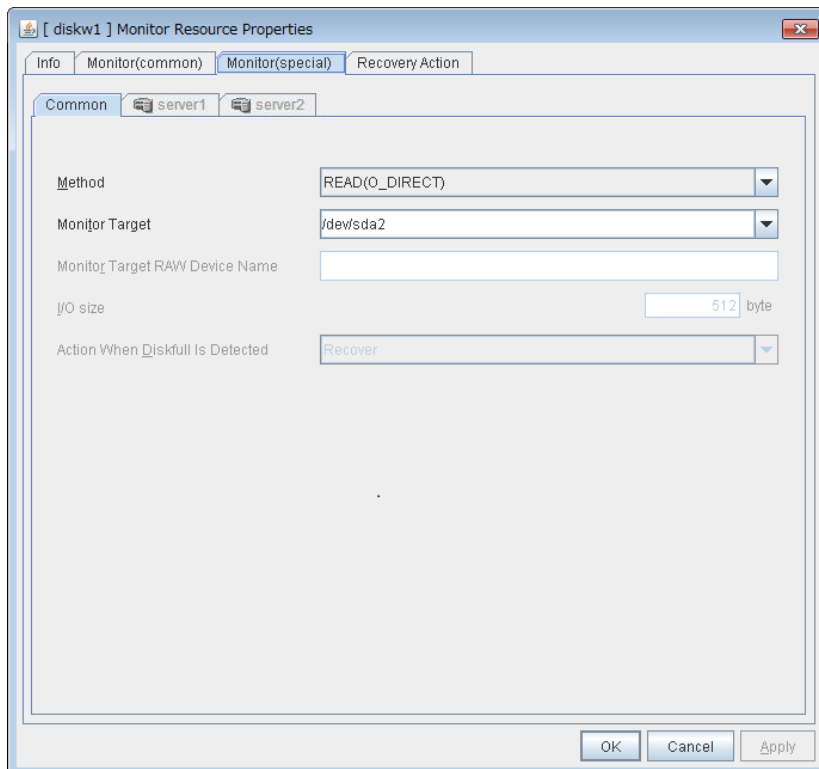

### Monitoring method (This can be individually specified for each server.)

Select the method used to monitor the disk device from the following:

- ◆ TUR
- ◆ TUR(generic)
- ◆ TUR(legacy)
- ◆ READ
- ◆ READ (O\_DIRECT)
- ◆ WRITE (FILE)
- ◆ READ (RAW)
- ◆ READ (VXVM)

### Monitor Target Name (Within 1023 bytes) **Server Individual Setup**

- ◆ When the monitoring method is WRITE (FILE):

Specify the path name of the file to be monitored. The name needs to begin with [/].

Specify the file name with the absolute path. If you specify the file name of an existing file, it is overwritten and the data in the file is lost.

- ◆ When the monitoring method is READ (O\_DIRECT)
 

Specify a path name of the device file or file to monitor. The name must begin with a forward slash (/).

Use an absolute path of the device file name or file name.

If a file name is specified, the file must have been created beforehand.

Do not specify a mirror partition device (such as /dev/NMP1) as the monitor target.
- ◆ When the monitoring method is READ (RAW)
 

The monitor target may be omitted. However, the monitor target raw device name must be specified. Specify this mode only when binding and monitoring the device. It is not possible to specify the device name for a partition device that has been mounted or will possible be mounted for monitoring.

In addition, a whole device (whole disk) of a partition device that has been mounted or will possibly be mounted cannot be specified for monitoring. Allocate a partition dedicated to monitoring. (Allocate 10 MB or more to the monitoring partition).The name must begin with a forward slash (/).
- ◆ When the monitoring method is READ (VXVM)
 

The fields are dim and not selectable.
- ◆ When the monitoring method is READ
 

Specify the name of the disk device or file to be used to monitor the disk device. The name must begin with a forward slash (/). If a file name is specified, the file must have been created beforehand. If a disk resource exists, the device name specified for the disk resource can be selected. If a mirror disk resource exists, the data partition device name specified for the mirror or hybrid disk resource can be selected.
- ◆ When the monitoring method is other than the above
 

Specify the name of the disk device to monitor. The name must begin with a forward slash (/). If a disk resource exists, the device name specified for the disk resource can be selected. If a mirror disk resource exists, the data partition device name specified for the mirror or hybrid disk resource can be selected.

**Monitor target raw device name** (This can be individually specified for each server.)

This can be specified only when the monitoring method is READ (raw) or READ (VXVM).

- ◆ When the monitoring method is READ (raw)
 

Enter a device name for raw accessing. A raw device that is already registered in the Disk I/F list under the server properties cannot be registered. Select READ (VXVM) as the monitoring method when monitoring a VxVM volume raw device.
- ◆ When the monitoring method is READ (VXVM)
 

Specify a VxVM volume raw device name. The READ (VXVM) monitoring method can be used only when the file system of the volume raw device is vxfs. The name must begin with a forward slash (/).

  - To create an association with a disk resource, specify the dependent disk resource for **Target Resource** in "Displaying and changing the settings of a monitor resource (Common to monitor resources)" on page 717. Specify that monitoring start after the specified disk resource is activated.

**I/O Size** 1 to 99999999 **Server Individual Setup**

Specify the size of I/O for reading or reading/writing when READ or WRITE (FILE) is selected as a monitoring method.

\* When READ (RAW) , READ(O\_DIRECT) or READ (VXVM) is specified, the **I/O size** text box is dim.

A single sector is read from the target device.

\* If TUR, TUR (generic), or TUR (legacy) is specified, this setting is ignored.

**Action When Diskfull Is Detected** **Server Individual Setup**

Select the action when diskfull (state in which the disk being monitored has no free space) is detected.

◆ Recover

The disk monitor resource recognizes an error upon the detection of disk full.

◆ Do not recover

The disk monitor resource recognizes a caution upon the detection of disk full.

\* If READ, READ (RAW), READ (VXVM), READ (O\_DIRECT), TUR, TUR (generic), or TUR (legacy) is specified, the **Action when diskfull is detected** option is grayed out.

When a local disk is specified in **Target Device Name**, a local disk on the server can be monitored.

- ◆ Example of settings to monitor the local disk /dev/sdb by READ method, and to reboot the OS when an error is detected:

Option	Value	Remarks
Target Device Name	/dev/sdb	SCSI disk in the second machine.
Method	READ	READ method.
Recovery Target	Nothing	-
Final Action	Stop cluster service and reboot OS	Reboot the OS.

- ◆ Example of settings to monitor the local disk /dev/sdb by TUR (generic) method, and select No Operation (sending an alert to the WebManager only) as the final action when an error is detected:

Option	Value	Remarks
Target Device Name	/dev/sdb	SCSI disk in the second machine.
Method	TUR(generic)	SG_IO method
Final Action	No Operation	

## Displaying the disk monitor resource properties with the WebManager

1. Start the WebManager.
2. When you click a disk monitor resource object, , in the tree view, the following information is displayed in the list view

Disk Monitor: diskw1		Details	
Common		server1	server2
Properties	Value		
Comment			
Method	READ(O_DIRECT)		
Monitor Target	/dev/sda		
Target RAW Device Name			
Status	Normal		
Resource Status on Each Server			
Server Name	Status		
server1	Normal		
server2	Normal		

Comment:	Comment on the disk monitor resource
Monitor method:	Monitoring method using disk monitor resources
Monitor Target:	The target to be monitored
Monitor target raw device name	The name of the raw device monitored using disk monitor resources
Status:	Disk monitor resource status
Server Name:	Server name
Status:	Status of the monitor resource on the server

When you click **Details**, the following information is displayed in the pop-up dialog box:

Properties	Value
Name	diskw1
Type	diskw
Monitor Timing	Always
Target Resource	
Interval (sec)	60
Timeout (sec)	120
Do Not Retry at Timeout Occurrence	Off
Do Not Execute Recovery Action at Timeout Occurrence	Off
Retry Count	1
Final Action	No operation
Execute Script Before Reactivation	Off
Execute Script Before Failover	Off
Execute Script before Final Action	Off
Recovery Target	LocalServer
Recovery Target Type	Itself
Recovery Script Threshold	0
Reactivation Threshold	0
Failover Threshold	0
Wait Time to Start Monitoring (sec)	0
Nice Value	0
Monitor Suspend Possibility	Possible
Dummy Failure Possibility	Possible
Collect Dump at Timeout Occurrence	Off
Run Migration Before Run Failover	Off
I/O Size (byte)	2000000
Action when diskfull is detected	Recover

Name:	Disk monitor resource name
Type:	Monitor resource type
Monitor Timing:	Timing to start monitoring
Target Resource:	Target to be monitored
Interval (sec):	Interval between monitoring (in seconds)
Timeout (sec):	Timeout for monitoring (in seconds)
Do Not Retry at Timeout Occurrence:	Whether or not to retry when timeout occurs
Do Not Execute Recovery Action at Timeout Occurrence:	Whether or not to execute recovery action when timeout occurs
Retry Count:	The number of retries to be made from detection of an error in the monitor target to establish the error as an error
Final Action:	Final action at detection of an error
Execute Script before Reactivation:	Whether the pre-reactivation script is executed upon the detection of an error
Execute Script before Failover:	Whether the pre-failover script is executed upon the detection of an error
Execute Script before Final Action:	Whether the pre-final-action script is executed upon the detection of an error
Recovery Target:	Target to be recovered when an error is detected
Recovery Target Type:	Type of target to be recovered when an error is detected
Recovery Script Threshold:	The number of times the recovery script is executed upon the detection of an error
Reactivation Threshold:	The number of reactivations to be made at detection of an error
Failover Threshold:	The number of failovers to be made at detection of an error
Wait Time to Start Monitoring (sec):	Time to wait before starting monitoring (in seconds)
Nice Value:	Monitor resource nice value
Monitor Suspended Possibility:	Possibility of suspending monitoring
Dummy Failure Possibility:	Possibility of Dummy Failure

Collect Dump at Timeout Occurrence:	Whether or not dump of monitor process is collected when timeout occurs
Run Migration Before Run Failover:	Whether or not migration is run before running failover
I/O Size (byte):	I/O size used for monitoring
Action when diskfull is detected:	Action when diskfull is detected.

## Understanding IP monitor resources

IP monitor resource monitors IP addresses using the ping command.

### Monitoring by IP monitor resources

IP monitor resource monitors specified IP addresses by using the ping command. If all IP addresses do not respond, the status is determined to be error.

To check the responses of IP addresses, packet types 0 (Echo Reply) and 8 (Echo Request) of ICMP are used.

- ◆ If you want to establish error when all of the multiple IP addresses have error, register all those IP addresses with one IP monitor resource.

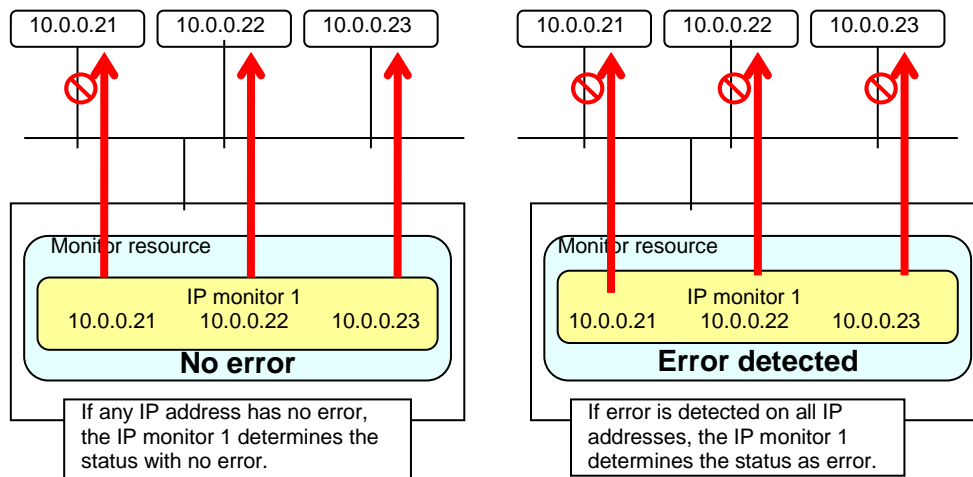

- ◆ If you want to establish error when any one of IP addresses has an error, create one IP monitor resource for each IP address.

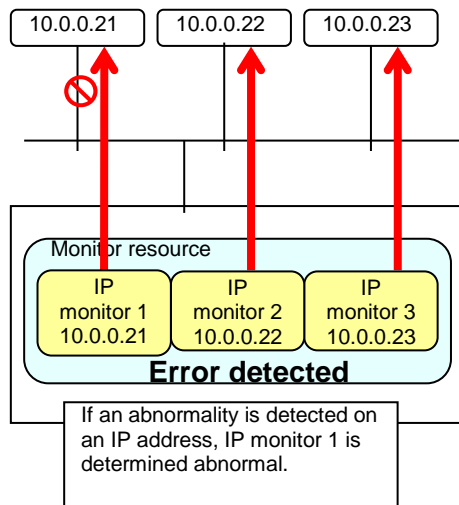



## Displaying and changing IP monitor resource details

1. Click the **Monitors** icon on the tree view displayed on the left side of the Builder window.
2. List of the monitor resources is displayed in the table view on the right side of the screen. Right-click the name of the target IP monitor resource, and click the **Monitor(special)** tab in the **Monitor Resource Property** window.
3. On the **Monitor(special)** tab, you can see and/or change the detailed settings by following the description below.

IP addresses to be monitored are listed in **IP Addresses**.

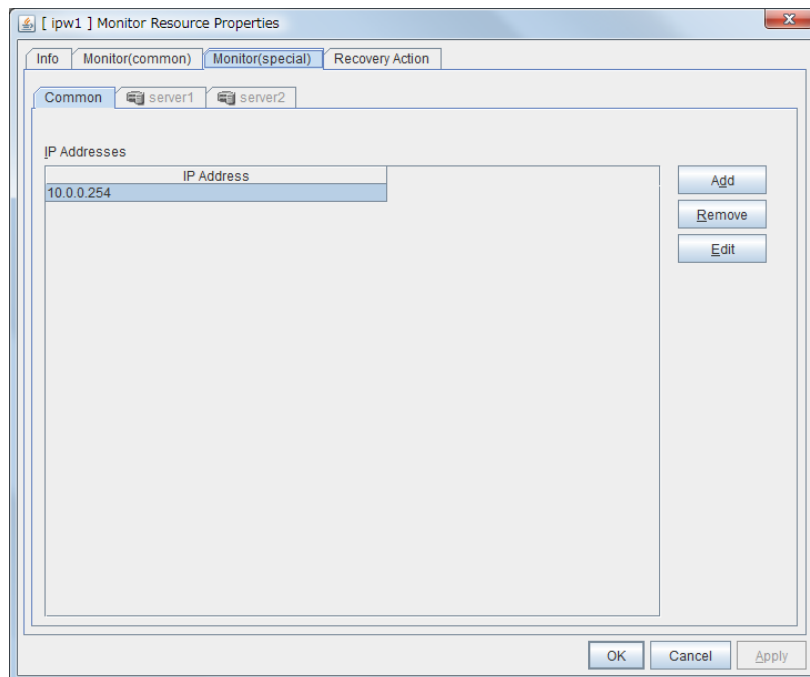

### Add

Click **Add** to add an IP address to be monitored.

A dialog box where an IP address can be entered is displayed.

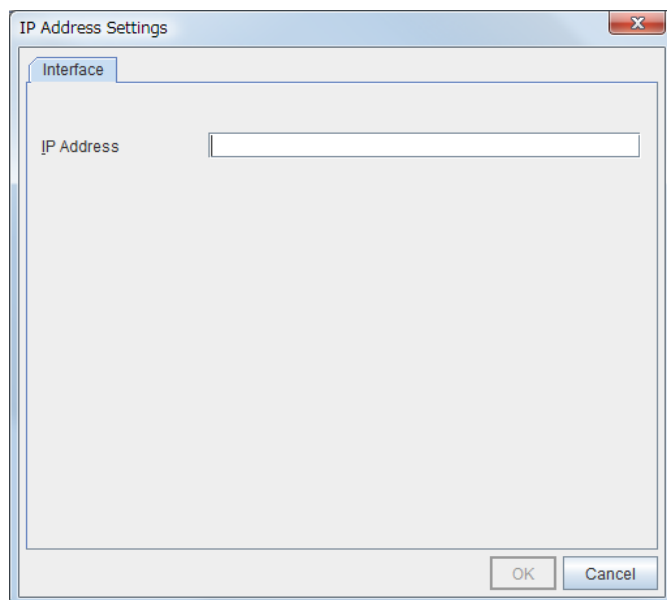

### IP Address (Within 255 bytes) **Server Individual Setup**

Enter an IP address or a host name to be monitored in this field and click **OK**.

The IP address or host name you enter here should be the one that exists on the public LAN.

If a host name is set, the name resolution in the OS (such as adding an entry to /etc/hosts) should be configured.

### Remove

Click **Remove** to remove an IP address selected in **IP Addresses** from the list so that it will no longer be monitored.

### Edit

Click **Edit** to display the **IP Address Settings** dialog box. The dialog box shows the IP address selected in **IP Addresses** on the **Parameter** tab. Edit the IP address and click **OK**.

## Displaying the IP monitor resource property with the WebManager

1. Start the WebManager.
2. When you click an IP monitor object, , in the tree view, the following information is displayed in the list view.

IP Monitor Name: ipw1		Details
<div style="display: flex; justify-content: space-between;"> <span>Common</span> <span>server1</span> <span>server2</span> </div>		
Properties	Value	
Comment		
IP Addresses	10.0.0.254	
Status	Normal	
Resource Status on Each Server		
Server Name	Status	
server1	Normal	
server2	Normal	

Comment:

IP Addresses:

Status:

Server Name:

Status:

Comment on the IP monitor resource

IP address to be monitored

IP monitor resource status

Server name

Status of the monitor resource on the server

When you click **Details**, the following information is displayed in the pop-up dialog box:

Properties	Value
Name	ipw1
Type	ipw
Monitor Timing	Always
Target Resource	
Interval (sec)	30
Timeout (sec)	30
Do Not Retry at Timeout Occurrence	Off
Do Not Execute Recovery Action at Timeout Occurrence	Off
Retry Count	0
Final Action	No operation
Execute Script Before Reactivation	Off
Execute Script Before Failover	Off
Execute Script before Final Action	Off
Recovery Target	LocalServer
Recovery Target Type	Itself
Recovery Script Threshold	0
Reactivation Threshold	0
Failover Threshold	0
Wait Time to Start Monitoring (sec)	0
Nice Value	0
Monitor Suspend Possibility	Possible
Dummy Failure Possibility	Possible
Collect Dump at Timeout Occurrence	Off
Run Migration Before Run Failover	Off

<b>Name:</b>	IP monitor resource name
<b>Type:</b>	Monitor resource type
<b>Monitor Timing:</b>	Timing to start monitoring
<b>Target Resource:</b>	Resource to be monitored
<b>Interval (sec):</b>	Interval between monitoring (in seconds)
<b>Timeout (sec):</b>	Timeout for monitoring (in seconds)
<b>Do Not Retry at Timeout Occurrence:</b>	Whether or not to retry when timeout occurs
<b>Do Not Execute Recovery Action at Timeout Occurrence:</b>	Whether or not to execute recovery action when timeout occurs
<b>Retry Count:</b>	The number of retries to be made from detection of an error in the monitor target to establish the error as error
<b>Final Action:</b>	Final action at detection of an error
<b>Execute Script before Reactivation:</b>	Whether the pre-reactivation script is executed upon the detection of an error
<b>Execute Script before Failover:</b>	Whether the pre-failover script is executed upon the detection of an error
<b>Execute Script before Final Action:</b>	Whether the pre-final-action script is executed upon the detection of an error
<b>Recovery Target:</b>	Target to be recovered when an error is detected
<b>Recovery Target Type:</b>	Type of target to be recovered when an error is detected
<b>Recovery Script Threshold:</b>	The number of times the recovery script is executed upon the detection of an error
<b>Reactivation Threshold:</b>	The number of reactivations to be made at detection of an error
<b>Failover Threshold:</b>	The number of failovers to be made at detection of an error
<b>Wait Time to Start Monitoring (sec):</b>	Time to wait before start monitoring (in seconds)
<b>Nice Value:</b>	Monitor resource nice value
<b>Monitor Suspended Possibility:</b>	Possibility of suspending monitoring
<b>Dummy Failure Possibility</b>	Possibility of Dummy Failure
<b>Collect Dump at Timeout Occurrence:</b>	Whether or not dump of monitor process is collected when timeout occurs
<b>Run Migration Before Run Failover:</b>	Whether or not migration is run before running failover

## Understanding floating IP monitor resources

Floating IP monitor resources monitor floating IP resources.

### Monitoring by floating IP monitor resources

Floating IP resources monitor floating IP resources in a server where they are activated. Floating IP monitor resources monitor whether floating IP addresses exist in the list of IP addresses. If a floating IP address does not exist in the list of IP addresses, it is determined to be an error.

Floating IP resources monitor Link Up/Down of NIC where a floating IP address is active. If NIC link down is detected, it is considered as an error. In some NIC boards and drivers, the required `ioctl()` may not be supported. In such a case, monitoring cannot be performed.

You can check the availability of the NIC Link Up/Down monitor by using the `[ethtool]` command provided by the distributor. For the check method using the `[ethtool]` command, see “Note on NIC Link Up/Down monitor resources” in “Understanding NIC Link Up/Down monitor resources” of this guide.

### Note on floating IP monitor resources

- ◆ This monitor resource is automatically registered when a floating IP resource is added. A floating IP monitor resource corresponding to a floating IP resource is automatically registered.  
Floating IP monitor resources are initially defaulted, so configure appropriate resource settings as needed.

## Displaying and changing floating IP monitor resource details

1. Click **Monitors** on the tree view displayed on the left side of the Builder window.
2. List of the monitor resources is displayed in the table view on the right side of the screen. Right click the target floating IP monitor resource, and click the **Monitor(special)** tab in the **Monitor Resource Property** window.
3. On the **Monitor(special)** tab, you can display and/or change the detailed settings by following the description below.

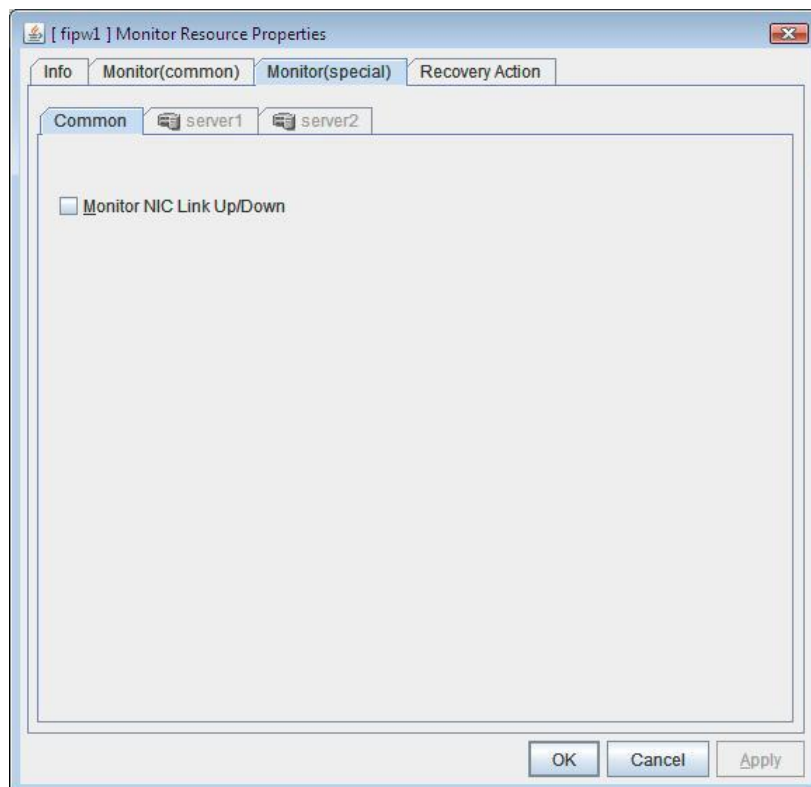

### Monitor NIC Link Up/Down

Specify whether to monitor NIC Link Up/Down. If you have enabled, you can monitor the NIC Link Up/Down for the NIC that granted the floating IP. For this reason, a new set of NIC Link Up/Down monitor resource for the NIC that granted the floating IP is not required.

## Displaying the floating IP monitor resource properties with the WebManager

1. Start the WebManager (*http://Management IP address or the IP address of the cluster server: port\_number* (the default value is 29003)).
2. Click an object for the application monitor resources  in the tree view. The following information is displayed in the list view.

Floating IP Monitor Name: fipw1		Details	
Common		server1	server2
Properties	Value		
Comment			
Status	Normal		
Resource Status on Each Server			
Server Name	Status		
server1	Normal		
server2	Offline		

Comment: Comment for floating the IP monitor resource  
 Status: Status of the floating IP monitor resource

### Resource Status on Each Server

Server Name: Server name of each server  
 Status: Status of the monitor resource on the given server

When you click **Details**, the following information is displayed in the pop-up dialog box.

Properties	Value
Name	fipw1
Type	fipw
Monitor Timing	Activating
Target Resource	fip1
Interval (sec)	60
Timeout (sec)	60
Do Not Retry at Timeout Occurrence	Off
Do Not Retry at Timeout Occurrence	Off
Retry Count	1
Final Action	No operation
Execute Script Before Reactivation	Off
Execute Script Before Failover	Off
Execute Script before Final Action	Off
Recovery Target	fip1
Recovery Target Type	Resource
Recovery Script Threshold	0
Reactivation Threshold	3
Failover Threshold	1
Wait Time to Start Monitoring (sec)	0
Nice Value	0
Monitor Suspend Possibility	Possible
Dummy Failure Possibility	Possible
Collect Dump at Timeout Occurrence	Off
Run Migration Before Run Failover	Off
Monitor NIC Link Up/Down	Off

Name:	Floating IP monitor resource name
Type:	Monitor resource type
Monitor Timing:	Timing for the monitor resource to start monitoring
Target Resource:	Resource to be monitored
Interval (sec):	Interval between monitoring (in seconds)
Timeout (sec):	Timeout for monitoring (in seconds)
Do Not Retry at Timeout Occurrence:	Whether or not to retry when timeout occurs
Do Not Execute Recovery Action at Timeout Occurrence:	Whether or not to execute recovery action when timeout occurs
Retry Count:	The number of retries to be made from detection of an error in the monitor target to establish the monitor resource as error
Final Action:	Final action at detection of an error
Execute Script before Reactivation:	Whether the pre-reactivation script is executed upon the detection of an error
Execute Script before Failover:	Whether the pre-failover script is executed upon the detection of an error
Execute Script before Final Action:	Whether the pre-final-action script is executed upon the detection of an error
Recovery Target:	Target to be recovered when an error is detected
Recovery Target Type:	Type of target to be recovered when an error is detected
Recovery Script Threshold:	The number of times the recovery script is executed upon the detection of an error
Reactivation Threshold:	The number of times activation is retried when an activation error is detected
Failover Threshold:	The number of failovers to be made at detection of an error
Wait Time to Start Monitoring (sec):	Time to wait before start monitoring (in seconds)
Nice Value:	Monitor resource nice value
Monitor Suspended Possibility:	Possibility of suspending monitoring
Dummy Failure Possibility:	Possibility of Dummy Failure



Collect Dump at Timeout Occurrence: Whether or not dump of monitor process is collected when timeout occurs  
Run Migration Before Run Failover: Whether or not migration is run before running failover  
Monitor NIC Link Up/Down: Monitor/Do not monitor NIC Link Up/Down

## Understanding NIC Link Up/Down monitor resources

### System requirements for NIC Link Up/Down monitor resource

#### Network interfaces supporting NIC Link Up/Down monitor resource

NIC Link Up/Down monitor resource has been tested to work in the following network interfaces.

Ethernet Controller(Chip)	Bus	Driver version
Intel 82557/8/9	PCI	3.5.10-k2-NAPI
Intel 82546EB	PCI	7.2.9
Intel 82546GB	PCI	7.3.20-k2-NAPI 7.2.9
Intel 82573L	PCI	7.3.20-k2-NAPI
Intel 80003ES2LAN	PCI	7.3.20-k2-NAPI
Broadcom BCM5721	PCI	7.3.20-k2-NAPI

### Note on NIC Link Up/Down monitor resources

Some NIC boards and drivers do not support required `ioctl()`.

Use the `ethtool` command distributors provide to check whether or not NIC Link Up/Down monitor resource runs. .

---

```

ethtool eth0
Settings for eth0:
    Supported ports: [ TP ]
    Supported link modes:   10baseT/Half 10baseT/Full
                           100baseT/Half 100baseT/Full
                           1000baseT/Full

    Supports auto-negotiation: Yes
    Advertised link modes:  10baseT/Half 10baseT/Full
                           100baseT/Half 100baseT/Full
                           1000baseT/Full

    Advertised auto-negotiation: Yes
    Speed: 1000Mb/s
    Duplex: Full
    Port: Twisted Pair
    PHYAD: 0
    Transceiver: internal
    Auto-negotiation: on
    Supports Wake-on: umbg
    Wake-on: g
    Current message level: 0x00000007 (7)
    Link detected: yes

```

---

- ◆ When the LAN cable link status ("Link detected: yes") is not displayed in the result of the `ethtool` command:

- It is highly likely that NIC Link Up/Down monitor resource of EXPRESSCLUSTER is unable to operate. Use the IP monitor resource instead.
  
- ◆ When LAN cable link status ("Link detected: yes") is displayed in the result of the ethtool command:
  - In most cases NIC Link Up/Down monitor resource of EXPRESSCLUSTER can operate, but sometimes it may not operate.
  - Particularly in the following hardware, NIC Link Up/Down monitor resource of EXPRESSCLUSTER may not operate. Use IP monitor resource instead.
    - When hardware is installed between the actual LAN connector and NIC chip such as a blade server

When you check if NIC Link Up/Down monitor resource can be used with the use of EXPRESSCLUSTER on a machine for a production environment, follow the steps below.

1. Register NIC Link Up/Down monitor resource with the configuration data.  
Select **No Operation** for the configuration of recovery operation of NIC Link Up/Down monitor resource upon failure detection.
2. Start the cluster.
3. Check the status of NIC Link Up/Down monitor resource.  
If the status of NIC Link Up/Down monitor resource is abnormal while LAN cable link status is normal, NIC Link Up/Down monitor resource cannot be used.
4. If NIC Link Up/Down monitor resource status becomes abnormal when LAN cable link status is made abnormal status (link down status), (NIC Link Up/Down monitor resource can be used).  
If the status remains to be normal, NIC Link Up/Down monitor resource cannot be used.

## Configuration and range of NIC Link Up/Down monitoring

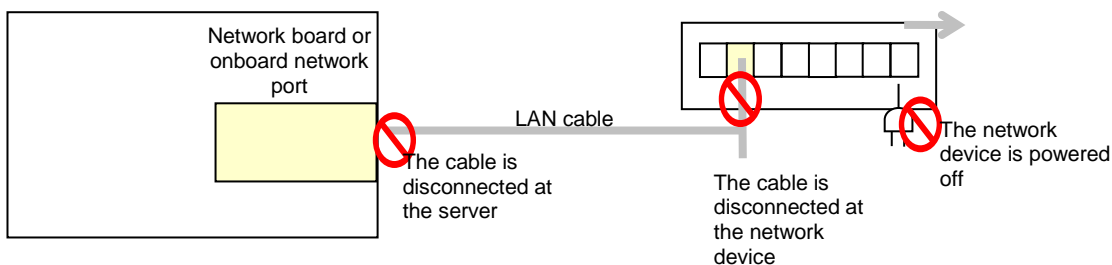

- ◆ The `ioctl()` to the NIC driver is used to find how the server is linked to the network. (For the IP monitoring, the status is judged by the ping response from the specified IP address.)
- ◆ You can monitor an NIC dedicated to interconnect (mirror connect). If you do this in the environment where two nodes are directly connected with a cross cable and one server fails, the other server is considered to be failing. This is because no link is established. The recovery action to be taken at detection of error should be configured with the appropriate value. For example, if **Stop cluster daemon and reboot OS** is selected, other servers will continue to restart the OS endlessly.

If the network is has a bonding status, it is possible to monitor the master interface (`bond0...`) as well as the slave interface (`eth0, eth1...`) in the lower level, while applying the bonding availability. It is recommended to use the settings below.

- ◆ Slave Interface Recovery action when an error is detected: Set no action
  - When only one of the network cables (`eth0`) fails, EXPRESSCLUSTER issues an alert, while no recovery action takes place. The network recovery is performed by bonding.
- ◆ Master Interface
  - Recovery action when an error is detected: Set actions such as failover and shutdown. When all slave interfaces fail (and the master interface is down), the EXPRESSCLUSTER performs the recovery action.

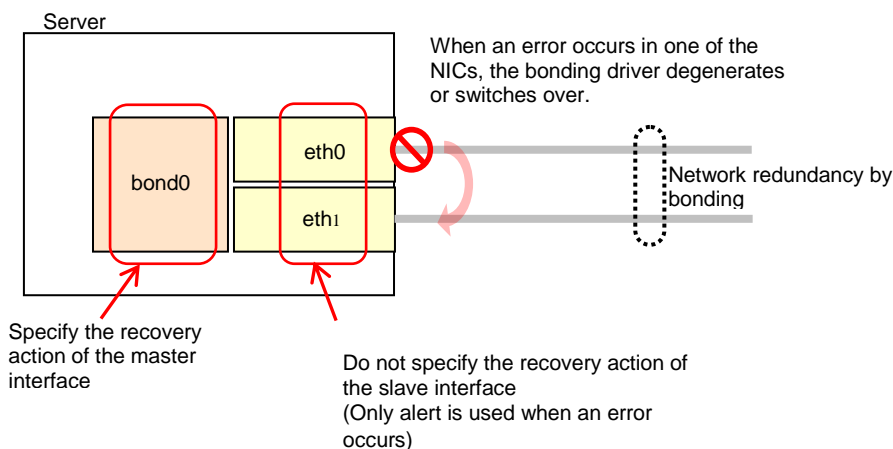

## Displaying and changing the NIC Link Up/Down monitor resource details

1. Click the **Monitors** icon on the tree view displayed on the left side of the Builder window.
2. List of the monitor resources is displayed in the table view on the right side of the screen. Right-click the name of the target NIC Link Up/Down monitor resource, and click the **Monitor(special)** tab in the **Monitor Resource Property** window.
3. On the **Monitor(special)** tab, you can see and/or change the detailed settings by following the description below.

NIC Link Up/Down monitor resource obtains the information on how the specified NIC is linked monitors the linkage is up or down.

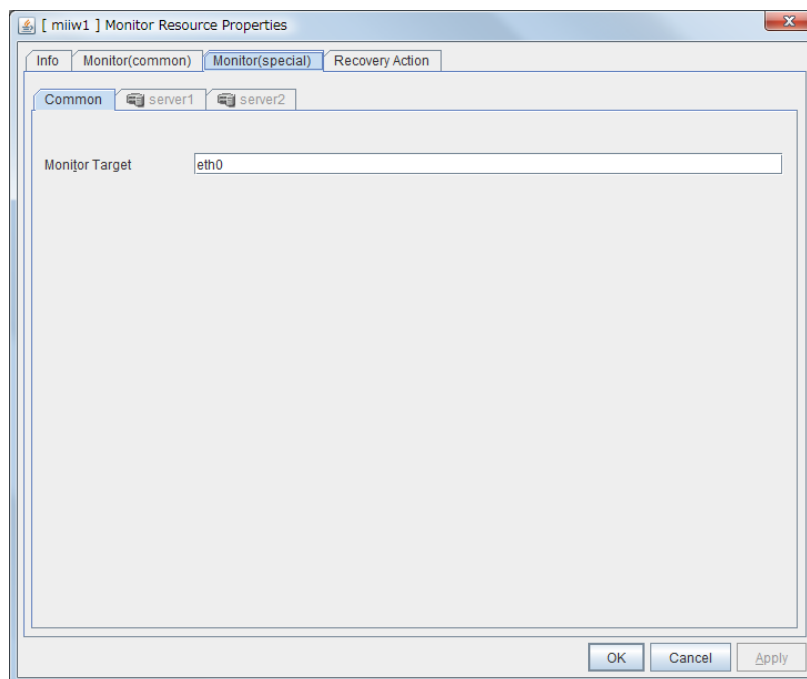

**Monitor Target** (Within 15 bytes) **Server Individual Setup**

Enter the name of the NIC interface you want to monitor. You can monitor Bond devices (e.g. bond.600) and team devices (e.g. team0). You can also monitor VLAN and tagVLAN (setting example: eth0.8).

## Displaying the NIC Link Up/Down monitor resource property with the WebManager

1. Start the WebManager.
2. When you click a NIC Link Up/Down monitor object, , in the tree view, the following information is displayed in the list view.

NIC Link Up/Down Monitor Name: miiw1		Details
<span>Common</span> <span>server1</span> <span>server2</span>		
Properties	Value	
Comment		
Monitor Target	eth0	
Status	Normal	
Resource Status on Each Server		
Server Name	Status	
server1	Normal	
server2	Normal	

Comment:	Comment of the NIC Link Up/Down monitor resource
Monitor Target:	The name of the NIC interface to be monitored by NIC Link Up/Down monitor resource
Status:	NIC Link Up/Down monitor resource status
Server Name:	Server name
Status:	Status of the monitor resource on the server

When you click **Details**, the following information is displayed in the pop-up dialog box:

Properties	Value
Name	miiw1
Type	miiw
Monitor Timing	Always
Target Resource	
Interval (sec)	10
Timeout (sec)	60
Do Not Retry at Timeout Occurrence	Off
Do Not Execute Recovery Action at Timeout Occurrence	Off
Retry Count	3
Final Action	No operation
Execute Script Before Reactivation	Off
Execute Script Before Failover	Off
Execute Script before Final Action	Off
Recovery Target	[All Groups]
Recovery Target Type	Group
Recovery Script Threshold	0
Reactivation Threshold	0
Failover Threshold	1
Wait Time to Start Monitoring (sec)	0
Nice Value	0
Monitor Suspend Possibility	Possible
Dummy Failure Possibility	Possible
Collect Dump at Timeout Occurrence	Off
Run Migration Before Run Failover	Off

Name:	NIC Link Up/Down monitor resource name
Type:	Monitor resource type
Monitor Timing:	Timing to start monitoring
Target Resource:	Resource to be monitored
Interval (sec):	Interval between monitoring (in seconds)
Timeout (sec):	Timeout for monitoring (in seconds)
Do Not Retry at Timeout Occurrence:	Whether or not to retry when timeout occurs
Do Not Execute Recovery Action at Timeout Occurrence:	Whether or not to execute recovery action when timeout occurs
Retry Count:	The number of retries to be made from detection of an error in the monitor target to establish the error as an error
Final Action:	Final action at detection of an error
Execute Script before Reactivation:	Whether the pre-reactivation script is executed upon the detection of an error
Execute Script before Failover:	Whether the pre-failover script is executed upon the detection of an error
Execute Script before Final Action:	Whether the pre-final-action script is executed upon the detection of an error
Recovery Target:	Target to be recovered when an error is detected
Recovery Target Type:	Type of target to be recovered when an error is detected
Recovery Script Threshold:	The number of times the recovery script is executed upon the detection of an error
Reactivation Threshold:	The number of reactivations to be made at detection of an error
Failover Threshold:	The number of failovers to be made at detection of an error
Wait Time to Start Monitoring (sec):	Time to wait before starting monitoring (in seconds)
Nice Value:	Monitor resource nice value
Monitor Suspended Possibility:	Possibility of suspending monitoring
Dummy Failure Possibility:	Possibility of Dummy Failure
Collect Dump at Timeout Occurrence:	Whether or not dump of monitor process is collected when timeout occurs

Run Migration Before Run Failover: Whether or not migration is run before running failover



## Understanding mirror disk connect monitor resources

### Note on mirror disk connect monitor resources

- ◆ A mirror disk connect monitor resource monitors a network for mirroring. If communication of mirror data using the specified mirror disk connect fails, it is recognized as an error. This resource is automatically registered when the mirror disk resource is added.
- ◆ When more than one mirror disk resource is added, the same number of mirror disk connect monitor resources as the one of mirror resources is automatically registered.

## Displaying and changing the mirror disk connect monitor resource details ~For Replicator ~

1. Click the **Monitors** icon on the tree view displayed on the left side of the Builder window.
2. List of the monitor resources is displayed in the table view on the right side of the screen. Right-click the target mirror disk connect monitor resource, and click the **Monitor(special)** tab in the **Monitor Resource Property** window.
3. On the **Monitor(special)** tab, you can see and/or change the detailed settings by following the description below.

---

**Note:**

Do not change the settings shown below on the **Error Detection** tab. With these settings, an alert message if an error is determined can be sent.

The **Error Detection** tab settings:

Recovery Target	Nothing
Reactivation Threshold	0 times
Failover Threshold	0 times
Final Action	No Operation

---

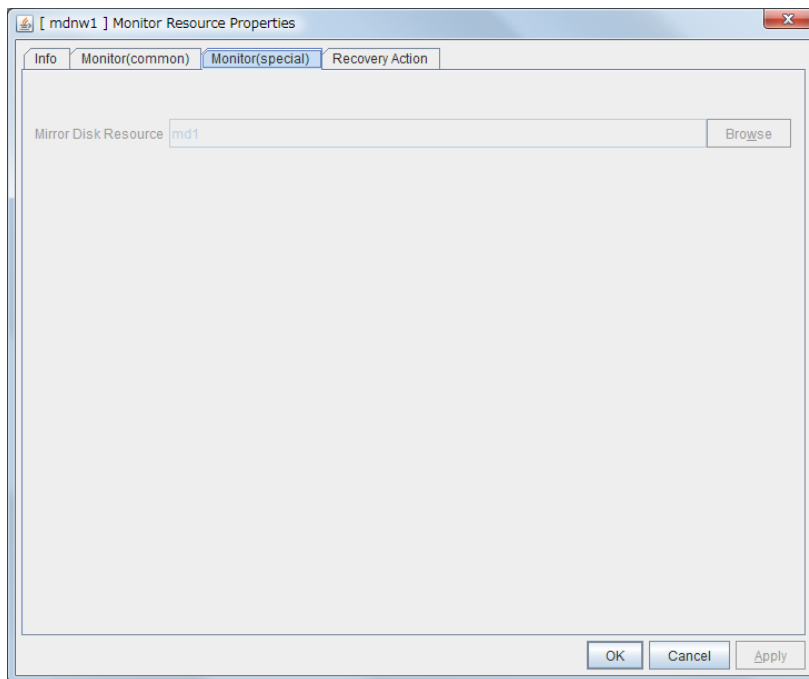

### Mirror Disk Resource

The mirror disk resource to be monitored is displayed.

## Displaying the mirror disk connect monitor resource property with the WebManager

1. Start the WebManager.
2. When you click a mirror disk connect monitor object, , in the tree view, the following information is displayed in the list view.

Mirror Disk Connect Monitor Name: mdnw1		Details	
Common		server1	server2
Properties	Value		
Comment			
Monitor Target	md1		
Status	Normal		
Resource Status on Each Server			
Server Name	Status		
server1	Normal		
server2	Normal		

Comment:

Comment of the mirror disk connect monitor resource

Monitor Target:

Mirror disk resource name that uses the mirror disk connect for monitoring on the mirror disk connect monitor resource

Status:

Mirror disk connect monitor resource status

Server Name:

Server name

Status:

Status of the monitor resource on the server

When you click **Details**, the following information is displayed in the pop-up dialog box:

Properties	Value
Name	mdnw1
Type	mdnw
Monitor Timing	Always
Target Resource	
Interval (sec)	60
Timeout (sec)	120
Do Not Retry at Timeout Occurrence	Off
Do Not Execute Recovery Action at Timeout Occurrence	Off
Retry Count	0
Final Action	No operation
Execute Script Before Reactivation	Off
Execute Script Before Failover	Off
Execute Script before Final Action	Off
Recovery Target	LocalServer
Recovery Target Type	Itself
Recovery Script Threshold	0
Reactivation Threshold	0
Failover Threshold	0
Wait Time to Start Monitoring (sec)	0
Nice Value	0
Monitor Suspend Possibility	Possible
Dummy Failure Possibility	Impossible
Collect Dump at Timeout Occurrence	Off
Run Migration Before Run Failover	Off

- Name: Mirror disk connect monitor resource name
- Type: Monitor resource type
- Monitor Timing: Timing to start monitoring
- Target Resource: Resource to be monitored
- Interval (sec): Interval between monitoring (in seconds)
- Timeout (sec): Timeout for monitoring (in seconds)
- Do Not Retry at Timeout Occurrence: Whether or not to retry when timeout occurs
- Do Not Execute Recovery Action at Timeout Occurrence: Whether or not to execute recovery action when timeout occurs
- Retry Count: The number of retries to be made from detection of an error in the monitor target to establish the error as an error
- Final Action: Final action at detection of an error
- Execute Script before Reactivation: Whether the pre-reactivation script is executed upon the detection of an error
- Execute Script before Failover: Whether the pre-failover script is executed upon the detection of an error
- Execute Script before Final Action: Whether the pre-final-action script is executed upon the detection of an error
- Recovery Target: Target to be recovered when an error is detected
- Recovery Target Type: Type of target to be recovered when a problem is detected
- Recovery Script Threshold: The number of times the recovery script is executed upon the detection of an error
- Reactivation Threshold: The number of reactivations to be made at detection of an error
- Failover Threshold: The number of failovers to be made at detection of an error
- Wait Time to Start Monitoring (sec): Time to wait before starting monitoring (in seconds)
- Nice Value: Monitor resource nice value
- Monitor Suspended Possibility: Possibility of suspending monitoring
- Dummy Failure Possibility: Possibility of Dummy Failure

Collect Dump at Timeout Occurrence: Whether or not dump of monitor process is collected when timeout occurs

Run Migration Before Run Failover: Whether or not migration is run before running failover

## Understanding mirror disk monitor resources

Mirror disk monitor resources monitor the state of date of mirror disk and the soundness of mirror driver.

### Note on mirror disk monitor resources

This resource is automatically registered when a mirror disk resource is added. A mirror disk monitor resource corresponding to a mirror disk resource is automatically registered.

### Displaying and changing the mirror disk monitor resource details

1. Click the **Monitors** icon on the tree view displayed on the left side of the Builder window.
2. List of the monitor resources is displayed in the table view on the right side of the screen. Right-click the target mirror disk monitor resource, and click the **Monitor(special)** tab in the **Monitor Resource Property** window.
3. On the **Monitor(special)** tab, you can see and/or change the detailed settings by following the description below.

---

#### Note:

Do not change the settings shown below on the **Error Detection** tab. With these settings, an alert message if an error is determined can be sent.

The **Error Detection** tab settings:

Recovery object	Nothing
Reactivation threshold	0 time
Failover threshold	0 time
Final Action	No Operation

---

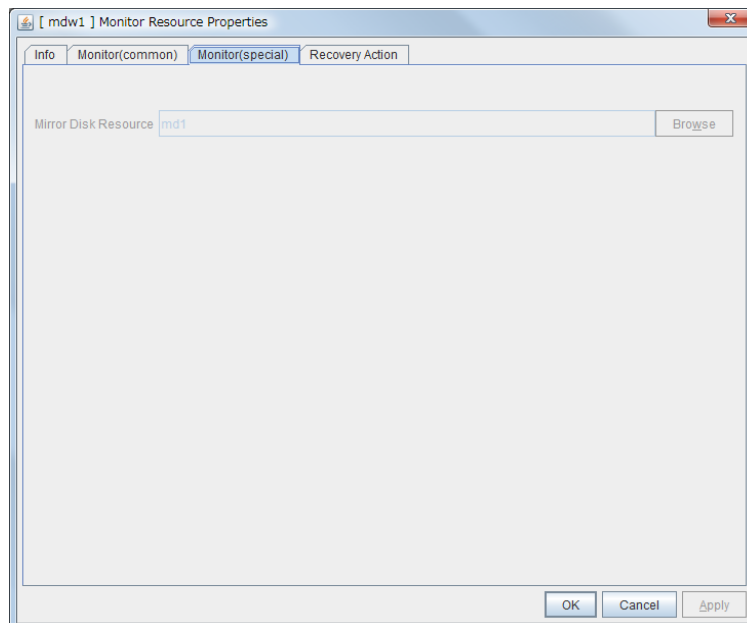

#### Mirror Disk Resource

The mirror disk resource to be monitored is displayed.

## Displaying the mirror disk monitor resource property with the WebManager

1. Start the WebManager.
2. When you click an object for a mirror disk monitor, , in the tree view, the following information is displayed in the list view.

Mirror Disk Monitor Name: mdw1		Details
Common		server1
server2		
Properties	Value	
Comment		
Monitor Target	md1	
Status	Normal	
Resource Status on Each Server		
Server Name	Status	
server1	Normal	
server2	Normal	

Comment:

Monitor Target:

Status:

Server Name:

Status:

Comment of the mirror disk monitor resource

The name of the mirror disk resource to be monitored by the mirror disk monitor resource

Mirror disk monitor resource status

Server name

Status of the monitor resource on the server

When you click **Details**, the following information is displayed in the pop-up dialog box:

Properties	Value
Name	mdw1
Type	mdw
Monitor Timing	Always
Target Resource	
Interval (sec)	10
Timeout (sec)	60
Do Not Retry at Timeout Occurrence	Off
Do Not Execute Recovery Action at Timeout Occurrence	Off
Retry Count	0
Final Action	No operation
Execute Script Before Reactivation	Off
Execute Script Before Failover	Off
Execute Script before Final Action	Off
Recovery Target	LocalServer
Recovery Target Type	Itself
Recovery Script Threshold	0
Reactivation Threshold	0
Failover Threshold	0
Wait Time to Start Monitoring (sec)	0
Nice Value	0
Monitor Suspend Possibility	Possible
Dummy Failure Possibility	Impossible
Collect Dump at Timeout Occurrence	Off
Run Migration Before Run Failover	Off

Name	Mirror disk monitor resource name
Type:	Monitor resource type
Monitor Timing:	Timing to start monitoring
Target Resource:	Resource to be monitored
Interval (sec):	Interval between monitoring (in seconds)
Timeout (sec):	Timeout for monitoring (in seconds)
Do Not Retry at Timeout Occurrence:	Whether or not to retry when timeout occurs
Do Not Execute Recovery Action at Timeout Occurrence:	Whether or not to execute recovery action when timeout occurs
Retry Count:	The number of retries to be made from detection of an error in the monitor target to establish the error as an error
Final Action:	Final action at detection of an error
Execute Script before Reactivation:	Whether the pre-reactivation script is executed upon the detection of an error
Execute Script before Failover:	Whether the pre-failover script is executed upon the detection of an error
Execute Script before Final Action:	Whether the pre-final-action script is executed upon the detection of an error
Recovery Target:	Target to be recovered when an error is detected
Recovery Target Type:	Type of target to be recovered when an error is detected
Recovery Script Threshold:	The number of times the recovery script is executed upon the detection of an error
Reactivation Threshold:	The number of reactivations to be made at detection of an error
Failover Threshold:	The number of failovers to be made at detection of an error
Wait Time to Start Monitoring (sec):	Time to wait before starting monitoring (in seconds)
Nice Value:	Monitor resource nice value
Monitor Suspended Possibility:	Possibility of suspending monitoring
Dummy Failure Possibility	Possibility of Dummy Failure
Collect Dump at Timeout Occurrence:	Whether or not dump of monitor process is collected when timeout occurs



Run Migration Before Run Failover: Whether or not migration is run before running failover

## Understanding hybrid disk connect monitor resources

### Note on hybrid disk connect monitor resources

- ◆ A mirror disk connect monitor resource monitors a network for mirroring. If communication of mirror data using the specified mirror disk connect fails, it is recognized as an error. This resource is automatically registered when the hybrid disk resource is added.
- ◆ When more than one hybrid disk resource is added, hybrid disk connect monitor resources as many as the number of the hybrid disk resources are automatically registered.

## Displaying and changing the hybrid disk connect monitor resource details ~For Replicator DR~

1. Click the **Monitors** icon on the tree view displayed on the left side of the Builder window.
2. List of the monitor resources is displayed in the table view on the right side of the screen. Right-click the target hybrid disk connect monitor resource, and click the **Monitor(special)** tab in the **Monitor Resource Property** window.
3. On the **Monitor(special)** tab, you can see and/or change the detailed settings by following the description below.

---

**Note:**

Do not change the settings shown below on the **Error Detection** tab. These are settings to send alert messages when the status is determined to be failure. .

The **Error Detection** tab settings:

Recovery Target	Nothing
Reactivation Threshold	0 times
Failover Threshold	0 times
Final Action	No Operation

---

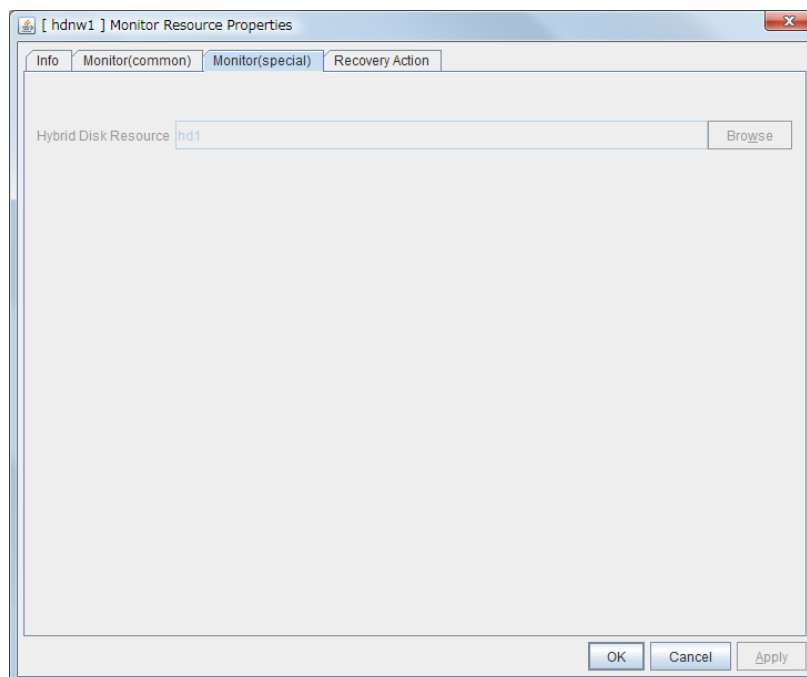
**Hybrid Disk Resource**

The hybrid disk resource to be monitored is displayed.

## Displaying the hybrid disk connect monitor resource property with the WebManager

1. Start the WebManager.
2. When you click a hybrid disk connect monitor object, , in the tree view, the following information is displayed in the list view.

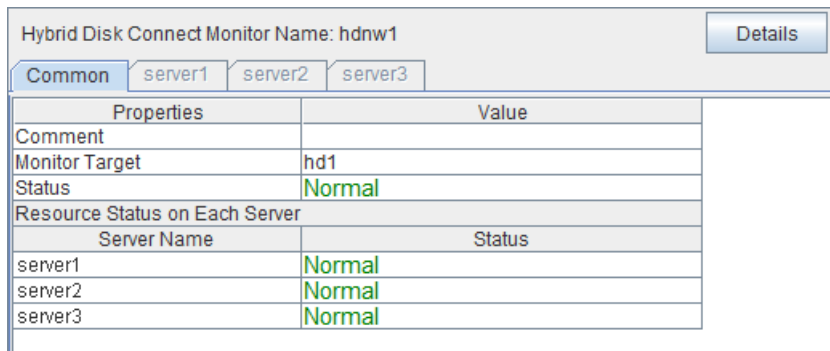

Properties		Value
Comment		
Monitor Target		hd1
Status		Normal
Resource Status on Each Server		
Server Name		Status
server1		Normal
server2		Normal
server3		Normal

Comment:	Comment of the hybrid disk connect monitor resource
Monitor Target:	Hybrid disk resource name that uses the mirror disk connect for monitoring on the hybrid disk connect monitor resource.
Status:	Hybrid disk connect monitor resource status
Server Name:	Server name
Status:	Status of the monitor resource on the server

When you click **Details**, the following information is displayed in the pop-up dialog box:

Properties	Value
Name	hdnw1
Type	hdnw
Monitor Timing	Always
Target Resource	
Interval (sec)	60
Timeout (sec)	120
Do Not Retry at Timeout Occurrence	Off
Do Not Execute Recovery Action at Timeout Occurrence	Off
Retry Count	0
Final Action	No operation
Execute Script Before Reactivation	Off
Execute Script Before Failover	Off
Execute Script before Final Action	Off
Recovery Target	LocalServer
Recovery Target Type	Itself
Recovery Script Threshold	0
Reactivation Threshold	0
Failover Threshold	0
Wait Time to Start Monitoring (sec)	0
Nice Value	0
Monitor Suspend Possibility	Possible
Dummy Failure Possibility	Impossible
Collect Dump at Timeout Occurrence	Off
Run Migration Before Run Failover	Off

Name:	Hybrid disk connect monitor resource name
Type:	Monitor resource type
Monitor Timing:	Timing to start monitoring
Target Resource:	Resource to be monitored
Interval (sec):	Interval between monitoring (in seconds)
Timeout (sec):	Timeout for monitoring (in seconds)
Do Not Retry at Timeout Occurrence:	Whether or not to retry when timeout occurs
Do Not Execute Recovery Action at Timeout Occurrence:	Whether or not to execute recovery action when timeout occurs
Retry Count:	The number of retries to be made from detection of an error in the monitor target to establish the error as an error
Final Action:	Final action at detection of an error
Execute Script before Reactivation:	Whether the pre-reactivation script is executed upon the detection of an error
Execute Script before Failover:	Whether the pre-failover script is executed upon the detection of an error
Execute Script before Final Action:	Whether the pre-final-action script is executed upon the detection of an error
Recovery Target:	Target to be recovered when an error is detected
Recovery Target Type:	Type of target to be recovered when a problem is detected
Recovery Script Threshold:	The number of times the recovery script is executed upon the detection of an error
Reactivation Threshold:	The number of reactivations to be made at detection of an error
Failover Threshold:	The number of failovers to be made at detection of an error
Wait Time to Start Monitoring (sec):	Time to wait before starting monitoring (in seconds)
Nice Value:	Monitor resource nice value
Monitor Suspended Possibility:	Possibility of suspending monitoring
Dummy Failure Possibility:	Possibility of Dummy Failure

Collect Dump at Timeout Occurrence: Whether or not dump of monitor process is collected when timeout occurs

Run Migration Before Run Failover: Whether or not migration is run before running failover

## Understanding hybrid disk monitor resources

Hybrid disk monitor resources monitor the status of the data in the hybrid disk and the health of the mirror driver.

### Note on hybrid disk monitor resources

This resource is automatically registered when a hybrid disk resource is added. Hybrid disk monitor resources corresponding to hybrid disk resources are automatically registered.

## Displaying and changing the hybrid disk monitor resource details

1. Click the **Monitors** icon on the tree view displayed on the left side of the Builder window.
2. List of the monitor resources is displayed in the table view on the right side of the screen. Right-click the target hybrid disk monitor resource, and click the **Monitor(special)** tab in the **Monitor Resource Property** window.
3. On the **Monitor(special)** tab, you can see and/or change the detailed settings by following the description below.

---

**Note:**

Do not change the settings shown below on the **Error Detection** tab. These are settings to send alert messages when the status is determined to be failure.

The **Error Detection** tab settings:

Recovery object	Nothing
Reactivation threshold	0 times
Failover threshold	0 times
Final Action	No Operation

---

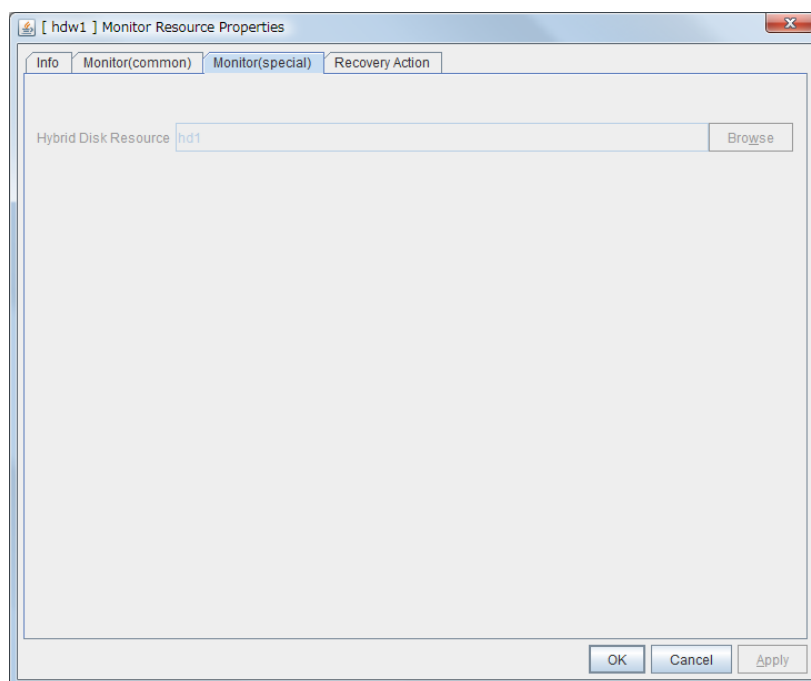

### Hybrid Disk Resource

The hybrid disk resource for monitoring is displayed.



## Displaying the hybrid disk monitor resource property with the WebManager

1. Start the WebManager.
2. When you click an object for a hybrid disk monitor, , in the tree view, the following information is displayed in the list view.

Hybrid Disk Monitor Name: hdw1		Details
Common		server1
server2		server3
Properties	Value	
Comment		
Monitor Target	hd1	
Status	Normal	
Resource Status on Each Server		
Server Name	Status	
server1	Normal	
server2	Normal	
server3	Normal	

Comment:

Comment of hybrid disk monitor resource

Monitor Target:

The name of the hybrid disk resource to be monitored by the hybrid disk monitor resource

Status:

Hybrid disk monitor resource status

Server Name:

Server name

Status:

Status of the monitor resource on the server

When you click **Details**, the following information is displayed in the pop-up dialog box:

Properties	Value
Name	hdw1
Type	hdw
Monitor Timing	Always
Target Resource	
Interval (sec)	10
Timeout (sec)	60
Do Not Retry at Timeout Occurrence	Off
Do Not Execute Recovery Action at Timeout Occurrence	Off
Retry Count	0
Final Action	No operation
Execute Script Before Reactivation	Off
Execute Script Before Failover	Off
Execute Script before Final Action	Off
Recovery Target	LocalServer
Recovery Target Type	Itself
Recovery Script Threshold	0
Reactivation Threshold	0
Failover Threshold	0
Wait Time to Start Monitoring (sec)	0
Nice Value	0
Monitor Suspend Possibility	Possible
Dummy Failure Possibility	Impossible
Collect Dump at Timeout Occurrence	Off
Run Migration Before Run Failover	Off

Name:	Hybrid disk monitor resource name
Type:	Monitor resource type
Monitor Timing:	Timing to start monitoring
Target Resource:	Resource to be monitored
Interval (sec):	Interval between monitoring (in seconds)
Timeout (sec):	Timeout for monitoring (in seconds)
Do Not Retry at Timeout Occurrence:	Whether or not to retry when timeout occurs
Do Not Execute Recovery Action at Timeout Occurrence:	Whether or not to execute recovery action when timeout occurs
Retry Count:	The number of retries to be made from detection of an error in the monitor target to establish the error as an error
Final Action:	Final action at detection of an error
Execute Script before Reactivation:	Whether the pre-reactivation script is executed upon the detection of an error
Execute Script before Failover:	Whether the pre-failover script is executed upon the detection of an error
Execute Script before Final Action:	Whether the pre-final-action script is executed upon the detection of an error
Recovery Target:	Target to be recovered when an error is detected
Recovery Target Type:	Type of target to be recovered when an error is detected
Recovery Script Threshold:	The number of times the recovery script is executed upon the detection of an error
Reactivation Threshold:	The number of reactivations to be made at detection of an error
Failover Threshold:	The number of failovers to be made at detection of an error
Wait Time to Start Monitoring (sec):	Time to wait before starting monitoring (in seconds)
Nice Value:	Monitor resource nice value
Monitor Suspended Possibility:	Possibility of suspending monitoring
Dummy Failure Possibility:	Possibility of Dummy Failure
Collect Dump at Timeout Occurrence:	Whether or not dump of monitor process is collected when timeout occurs

Run Migration Before Run Failover: Whether or not migration is run before running failover

## Understanding PID monitor resources

### Note on PID monitor resources

PID monitor resource monitors a successfully activated EXEC resource. The EXEC resource can be monitored if its settings for activation are configured to **Asynchronous**.

### Setting PID monitor resources

PIC monitor resource monitors a successfully activated EXEC resource. By monitoring the presence of process ID, an error is established when the process ID disappears.

The exec resource to be monitored is set according to the steps described in “Target Resource” of “Displaying and changing the settings of a monitor resource” on page 873.

The exec resource can be monitored if its settings for activation are configured to **Asynchronous**.

You cannot detect stalled status of the process.

---

**Note:**

To monitor stalls such as data base, samba, apache, and sendmail, purchase optional EXPRESSCLUSTER product.

---

## Displaying the PID monitor resource property with the WebManager

1. Start the WebManager.
2. When you click a PID monitor object, , in the tree view, the following information is displayed in the list view.

PID Monitor Name: pidw1		Details
<div style="display: flex; border-bottom: 1px solid black;"> <span style="border: 1px solid black; padding: 2px 5px;">Common</span> <span style="border: 1px solid black; padding: 2px 5px; margin-left: 5px;">server1</span> <span style="border: 1px solid black; padding: 2px 5px; margin-left: 5px;">server2</span> </div>		
Properties	Value	
Comment		
Target PID	14602	
Status	Normal	
Resource Status on Each Server		
Server Name	Status	
server1	Normal	
server2	Offline	

Comment:

Comment of the PID monitor resource

Target PID:

PID of the process monitored by the PID monitor resource

Status:

PID monitor resource status

Server Name:

Server name

Status:

Status of the monitor resource on the server

When you click **Details**, the following information is displayed in the pop-up dialog box:

Properties	Value
Name	pidw1
Type	pidw
Monitor Timing	Activating
Target Resource	exec1
Interval (sec)	5
Timeout (sec)	60
Do Not Retry at Timeout Occurrence	Off
Do Not Retry at Timeout Occurrence	Off
Retry Count	0
Final Action	No operation
Execute Script Before Reactivation	Off
Execute Script Before Failover	Off
Execute Script before Final Action	Off
Recovery Target	LocalServer
Recovery Target Type	Itself
Recovery Script Threshold	0
Reactivation Threshold	0
Failover Threshold	0
Wait Time to Start Monitoring (sec)	0
Nice Value	0
Monitor Suspend Possibility	Possible
Dummy Failure Possibility	Possible
Collect Dump at Timeout Occurrence	Off
Run Migration Before Run Failover	Off

**Name:** PID monitor resource name  
**Type:** Monitor resource type  
**Monitor Timing:** Timing to start monitoring  
**Target Resource:** Resource to be monitored  
**Interval (sec):** Interval between monitoring (in seconds)  
**Timeout (sec):** Timeout for monitoring (in seconds)  
**Do Not Retry at Timeout Occurrence:** Whether or not to retry when timeout occurs  
**Do Not Execute Recovery Action at Timeout Occurrence:** Whether or not to execute recovery action when timeout occurs  
**Retry Count:** The number of retries to be made from detection of an error in the monitor target to establish the error as an error  
**Final Action:** Final action at detection of an error  
**Execute Script before Reactivation:** Whether the pre-reactivation script is executed upon the detection of an error  
**Execute Script before Failover:** Whether the pre-failover script is executed upon the detection of an error  
**Execute Script before Final Action:** Whether the pre-final-action script is executed upon the detection of an error  
**Recovery Target:** Target to be recovered when an error is detected  
**Recovery Script Threshold:** The number of times the recovery script is executed upon the detection of an error  
**Recovery Target Type:** Type of target to be recovered when an error is detected  
**Reactivation Threshold:** The number of reactivations to be made at detection of an error  
**Failover Threshold:** The number of failovers to be made at detection of an error  
**Wait Time to Start Monitoring (sec):** Time to wait before starting monitoring (in seconds)  
**Nice Value:** Monitor resource nice value  
**Monitor Suspend Possibility:** Possibility of suspending monitoring  
**Dummy Failure Possibility:** Possibility of Dummy Failure  
**Collect Dump at Timeout Occurrence:** Whether or not dump of monitor process is collected when timeout occurs

Run Migration Before Run Failover: Whether or not migration is run before running failover

## Understanding user-mode monitor resources

### Drivers that user-mode monitor resources depend

#### Monitor by: **softdog**

softdog

- ◆ If softdog is selected as a monitoring method, the softdog driver is required.
- ◆ Use a loadable module configuration. User-mode monitor resources do not work on the static driver.
- ◆ If the softdog driver is not available, monitoring cannot be started.

#### Monitor by: **keepalive**

clpka

clpkhb

- ◆ If keepalive is selected as a monitoring method, the clpkhb driver and the clpka driver of the EXPRESSCLUSTER are required.
- ◆ When keepalive is set to the monitoring method, it is recommended to set the kernel mode LAN heartbeat. To use the kernel mode LAN heartbeat, the clpkhb driver is required.
- ◆ The clpka driver and the clpkhb driver are provided by EXPRESSCLUSTER. For information on support, refer to “Software Supported distributions and kernel versions” in Chapter 3, “Installation requirements for EXPRESSCLUSTER” in the *Getting Started Guide*.
- ◆ You cannot start monitoring if the clpkhb driver and the clpka driver cannot be used.

#### Monitor by: **ipmi (High-End Server Option)**

ipmi

- ◆ If ipmi (High-End Server Option) is used as a monitoring method, this driver is required.
- ◆ If the ipmi driver is not loaded, monitoring cannot be started.

### rpm that user-mode monitor resources depend

#### Monitor by: **ipmi**

ipmiutil

- ◆ If ipmi is used as a monitoring method, it is required to install this rpm of ipmiutil.
- ◆ If this rpm is not installed, monitoring cannot be started.



## How monitor user-mode monitor resources perform monitoring

You can select how a user-mode monitor resource monitors its target from the following:

### Monitor by: **softdog**

If **softdog** is selected as a monitoring method, the **softdog** driver of the OS is used.

### Monitor by: **ipmi**

If **ipmi** is selected as a monitoring method, **ipmiutil** is used. If **ipmiutil** is not installed, you need to install it.

### Monitor by: **keepalive**

If **keepalive** is selected as a monitoring method, the **clpkhb** and the **clpka** drivers are used.

---

#### **Note:**

Always check the distributions and the kernel versions on which the **clpkhb** driver and the **clpka** driver can be operated with “Software Supported distributions and kernel versions” in Chapter 3, “Installation requirements for EXPRESSCLUSTER” in the *Getting Started Guide*.

Check them when applying a security patch released by a distributor to the operating cluster (when the kernel version changes).

---

### Monitor by: **ipmi (High-End Server Option)**

If **ipmi (High-End Server Option)** is selected as a monitoring method, the **ipmi** driver is used.

### Monitor by: **none**

“none” is a monitoring method is used for evaluation. This only executes operations of the advanced settings of the user-mode monitor resource. Do not use this in a production environment.

## Advanced settings of user-mode monitor resource

Opening/closing of a dummy file, writing to a dummy file and creating a dummy thread are the configurations that allow advance user-mode monitor resource. If any of these configurations fail, the timer will not be updated. If a configuration continues to fail for the period of time set for the timeout or heartbeat timeout, the OS is reset.

### Opening/closing a dummy file

A dummy file is created, opened, closed and then deleted at every monitoring interval repeatedly.

- ◆ When this advanced function is set and there is no free disk space, opening the dummy file fails and the OS is reset.

### Writing to a dummy file

A specified size of data is written into a dummy file at every monitoring interval.

- ◆ This advanced function is not available unless opening/closing a dummy file is set.

### Creating a dummy thread

A dummy thread is created at every monitoring interval.

## User-mode monitor resource logic

The following sections describe how processes and features differ by ways of monitoring. For the shutdown stall monitoring, only Step 1 in each process overview is performed.

### Monitoring method: IPMI

- ◆ Process overview
  - Steps 2 to 7 of the process are repeated.
    1. Set the IPMI timer
    2. Open a dummy file
    3. Write to the dummy file
    4. Execute `fdatasync` for the dummy file
    5. Close the dummy file
    6. Create a dummy thread
    7. Updated the IPMI timer

Steps 2 to 6 of the process overview are for advanced settings. To execute these steps, you need to configure the settings.
  
- ◆ What happens when timeout does not occur (i.e. Steps 2 to 7 are performed without any problem):

Recovery actions such as resetting are not performed.
  
- ◆ What happens when timeout occurs (i.e. any of Steps 2 to 7 is stopped or delayed):

Reset is performed by BMC (the management function of the server).
  
- ◆ Advantages
  - This method of is less likely to be impacted by a kernel space failure, which makes chance of reset higher because BMC (the management function of the server itself) is used.
  
- ◆ Disadvantages
  - This method is not available on servers not supporting IPMI or on which `ipmiutil` does not run. This is because this monitoring method is hardware dependent.
  - This method is not available on a server where NEC ESMPRO Agent is used.
  - This method may not be able to coexist with software programs for server monitoring that are supplied by server vendors.
  - `ipmiutil` is not provided in some architectures.

**Monitoring method: softdog**

- ◆ Process overview  
Steps 2 to 7 of the process are repeated.
  1. Set softdog
  2. Open a dummy file
  3. Write to the dummy file
  4. Execute `fdatasync` for the dummy file
  5. Close the dummy file
  6. Create a dummy thread
  7. Update the softdog timerSteps 2 to 6 of the process overview are for advanced settings. To execute these steps, you need to configure the settings.
  
- ◆ What happens when timeout does not occur (i.e. Steps 2 to 7 are performed without any problem):  
Recovery actions such as reset are not performed.
  
- ◆ What happens when timeout occurs (i.e. any of Steps 2 to 7 is stopped or delayed):  
Reset is performed by softdog.
  
- ◆ Advantages
  - Since this method is not dependent on hardware, you can use it as long as there is a softdog kernel module.  
(In some distributions, softdog is not provided by default. Check that you have softdog before configuring the settings.)
  
- ◆ Disadvantages
  - Because softdog is dependent on the timer logic of the kernel space, reset may not be performed if an error occurs in the kernel space.

**Monitoring method: keepalive**

- ◆ Process overview  
Steps 2 to 7 are repeated.
  1. Set the keepalive timer
  2. Open a dummy file
  3. Execute write to the dummy file
  4. Execute `fdatasync` to the dummy file
  5. Close the dummy file
  6. Create a dummy thread
  7. Update the keepalive timerSteps 2 to 6 of the process overview are for advanced settings. To execute these steps, you need to configure the settings

- ◆ When a timeout does not occur (i.e. Steps 2 to 7 are performed without any problem): Recovery actions such as reset are not performed.
- ◆ When a timeout occurs (i.e. any of Steps 2 to 7 is stopped or delayed):
  - Reset of the local server is announced to other servers through clpkhb.ko.
  - Reset or panic is performed by clpka.ko according to the action setting.
- ◆ Advantage
  - Logs are recorded on other servers by announcement of the reset of the local server through execution of clpkhb.
- ◆ Disadvantages
  - Distributions, architectures, kernel versions which can be operated (which provide drivers) are limited.
  - Because clpka is dependent on the timer logic of the kernel space, reset may not be performed if an error occurs in the kernel space.

**Monitoring method: ipmi (High-End Server Option)**

- ◆ It can't be used.

## Checking availability of IPMI

You can quickly check if ipmiutil runs on the server by following the steps below:

1. Install the rpm package in the downloaded ipmiutil<sup>5</sup>.
2. Run `/usr/sbin/wdt` or `/usr/sbin/iwdt`.
3. Check the result of the execution.

**When you see the following (the result of `/usr/sbin/wdt`):**

(This is an example. Different values may be shown depending on your hardware devices.)

---

```
wdt ver 1.8
-- BMC version 0.8, IPMI version 1.5
wdt data: 01 01 01 00 31 17 31 17
Watchdog timer is stopped for use with BIOS FRB2. Logging
      pretimeout is 1 seconds, pre-action is None
      timeout is 593 seconds, counter is 593 seconds
      action is Hard Reset
```

---

You can use ipmiutil. ipmi can be chosen as a monitoring method.

**When you see the following (the result of `/usr/sbin/wdt`):**

---

```
wdt version 1.8
ipmignu_cmd timeout, after session activated
```

---

You cannot use ipmiutil. Do not choose ipmi as a monitoring method.

---

<sup>5</sup> ipmiutil is installed with a distribution in some distributions. If you use such a distribution, installing the ipmi-until rpm package is not required.

## IPMI command

In the user-mode monitor resource and shutdown monitoring, the following command and options in ipmiutil are used.

Command	Option	Timing to use	
		User mode stallmonitor	Shutdown stall monitor
Wdt iwtd	-e (start timer)	When starting	When starting monitoring
	-d (stop timer)	When stopping	When stopping (SIGTERM enabled)
	-r (update timer)	When starting/at every monitoring interval	When starting monitoring
	-t (set timeout value)	When starting/ when changing the monitoring interval	When starting monitoring

## User-mode monitor resources

### All monitoring methods:

- ◆ When a cluster is added by the Builder, a user-mode monitor resource of softdog is automatically created.
- ◆ A user-mode monitor resource with different monitoring method can be added. A user-mode monitor resource of softdog that was automatically created can be deleted when a cluster is added.
- ◆ When the activation of a user-mode monitor resource fails due to a reason such as the softdog driver of OS or the clpkhb/clpka driver of EXPRESSCLUSTER does not exist, or the rpm for ipmiutil is not installed, “Monitor userw failed.” will be displayed on the alert view in the WebManager. In the tree view of the WebManager, as the response to the clpstat command, Normal will be displayed as the resource status, and Offline will be displayed as the status of each server.

### Monitoring by IPMI:

- ◆ For notes on ipmi, see “IPMI command” in “Displaying and changing the settings of the time when an error is detected by a monitor resource (Common to monitor resources)” on page 883.

Operation in the following combinations has been tested.

Distribution	kernel version	ipmiutil version	Server
Red Hat Enterprise Linux AS 5 (update1)	2.6.18-53.el5	ipmiutil-1.7.9-1.x86_64.rpm	Express5800/120Rg-1
Red Hat Enterprise Linux AS 4 (update6)	2.6.9-67.EL smp	ipmiutil-2.0.8-1.x86_64.rpm	Express5800/120Rg-1
Asianux Server 3	2.6.18-8.10AXxen	ipmiutil-1.7.9-1.x86_64.rpm	Express5800/120Rg-2
Red Hat Enterprise Linux AS 5 (update4)	2.6.18-164.el5	ipmiutil-2.6.1-1.x86_64.rpm	Express5800/120Rf-1

---

**Note:**

If you are using a software program for server monitoring provided by a server vendor such as NEC ESMPRO Agent, do not choose IPMI as a monitoring method. Because these software programs for server monitoring and ipmiutil both use BMC (Baseboard Management Controller) on the server, a conflict occurs, preventing successful monitoring.

---

**Monitoring by ipmi (High-End Server Option)**

- ◆ It can't be used.

**Monitoring by keepalive**

Notification to other servers are performed only when a kernel mode LAN heartbeat resource is set. In this case, the following log is displayed on the syslog.

```
kernel: clpka: <server priority: %d> <reason: %s> <process  
name: %s>system reboot.
```

## Displaying and changing the user-mode monitor resource details

User-mode monitor resource considers stalling in user space as an error. This resource is automatically registered when a cluster is added. The user-mode monitor resource of softdog is automatically registered. The monitoring method is softdog.

1. Click the **Monitors** icon on the tree view displayed on the left side of the Builder window.
2. List of the monitor resources is displayed in the table view on the right side of the screen. Right-click the target user-mode monitor resource, and click the **Monitor(special)** tab in the **Monitor Resource Property** window.
3. On the **Monitor(special)** tab, you can see and/or change the detailed settings by following the description below.

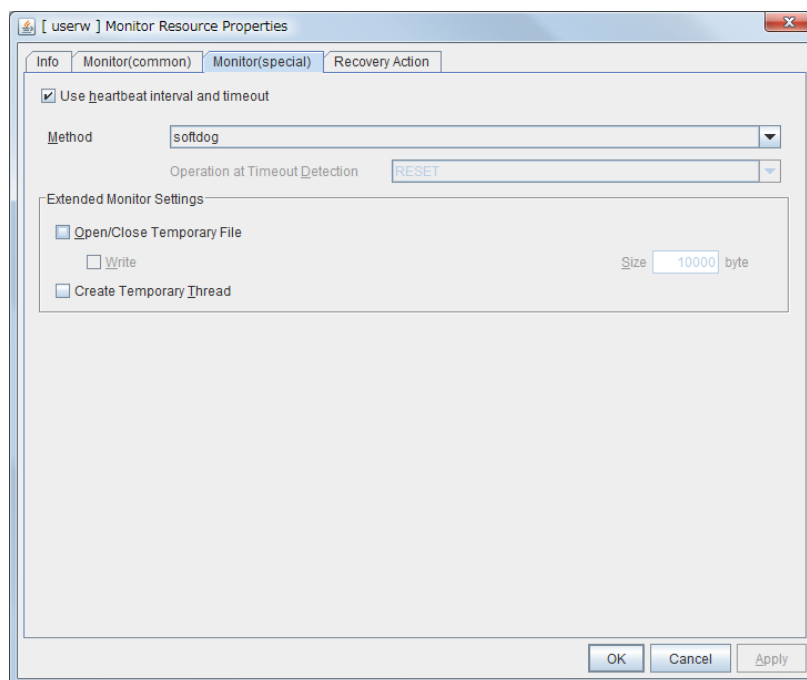

### Use heartbeat interval and timeout

Select this check box if you use heartbeat's interval and timeout for monitor's interval and timeout.

- ◆ When the check box is selected:  
Heartbeat interval and timeout are used.
- ◆ When the check box is not selected:  
Heartbeat is not used. Interval and timeout specified on the **Monitor** tab are used. You need to set a larger value for timeout than interval.  
When ipmi is specified to **Method**, you need to specify 255 or less for timeout.

### Method

Choose how you want to monitor the user-mode monitor resource from the following. You can not select a method which has already been used for other user-mode monitor resource.

- ◆ softdog:  
Uses softdog driver
- ◆ ipmi:  
Uses ipmiutil
- ◆ keepalive:  
Uses clpkhb driver and clpka driver.
- ◆ ipmi(High-End Server Option):  
It can't be used.
- ◆ No Operation:  
Uses nothing.

### Operation at timeout detection

Select the final action. This can be set only when the monitoring method is keepalive.

- ◆ RESET:  
Resets the server.
- ◆ PANIC:  
Performs a panic of the server.
- ◆ IOFENCING:  
It can't be used.

### Open/Close temporary file

Select this check box if you want to open/close a dummy file at every interval when you execute monitoring.

- ◆ When the check box is selected:  
A dummy file will be opened/closed.
- ◆ When the check box is not selected:  
A dummy file will not be opened/closed.

### Write

Select this check box if you have chosen to open/close a dummy file and want to write in dummy data.

- ◆ When the check box is selected:  
Dummy data is written into a dummy file.
- ◆ When the check box is not selected:  
Dummy data is not written into a dummy file.

**Size** 1 to 9999999

If you have chosen to write dummy data into a dummy file, specify the size to write in.



### **Create Temporary Thread**

Select this check box if you want to create a dummy thread when monitoring is performed.

- ◆ When the check box is selected:  
Temporary thread will be created.
- ◆ When the check box is no selected:  
Temporary thread will not be created.

## Displaying the user-mode monitor resource property with the WebManager

1. Start the WebManager.
2. When you click a user-mode monitoring resource object, , in the tree view, the following information is displayed in the list view.

User-Mode Monitor Name: userw		Details
<span>Common</span> <span>server1</span> <span>server2</span>		
Properties	Value	
Comment		
Method	softdog	
Use HB interval and timeout	On	
Status	Normal	
Resource Status on Each Server		
Server Name	Status	
server1	Normal	
server2	Normal	

Comment:	Comment of the user-mode monitor resource
Method:	Monitoring method
Use HB Interval and Timeout:	Whether or not to use HB interval/timeout value
Status:	Status of the user-mode monitor resource
Server Name:	Server name
Status:	Status of the monitor resource on the server

When you click **Details**, the following information is displayed in the pop-up dialog box:

Properties	Value
Name	userw
Type	userw
Monitor Timing	Always
Target Resource	
Interval (sec)	3
Timeout (sec)	90
Do Not Retry at Timeout Occurrence	Off
Do Not Execute Recovery Action at Timeout Occurrence	Off
Retry Count	0
Final Action	0
Execute Script Before Reactivation	Off
Execute Script Before Failover	Off
Execute Script before Final Action	Off
Recovery Target	LocalServer
Recovery Target Type	Itself
Recovery Script Threshold	0
Reactivation Threshold	0
Failover Threshold	0
Wait Time to Start Monitoring (sec)	0
Nice Value	-20
Monitor Suspend Possibility	Possible
Dummy Failure Possibility	Impossible
Collect Dump at Timeout Occurrence	Off
Run Migration Before Run Failover	Off
Action	RESET
Open/Close Temporary File with Writing	Off
Size (byte)	10000
Create Temporary Thread	Off

- Name: User-mode monitor resource name
- Type: Monitor resource type
- Monitor Timing: Timing to start monitoring
- Target Resource: Resource to be monitored
- Interval (sec): Interval between monitoring (in seconds)
- Timeout (sec): Timeout for monitoring (in seconds)
- Do Not Retry at Timeout Occurrence: Whether or not to retry when timeout occurs
- Do Not Execute Recovery Action at Timeout Occurrence: Whether or not to execute recovery action when timeout occurs
- Retry Count: The number of retries to be made from detection of an error in the monitor target to establish the error as error
- Final Action: Final action at detection of an error
- Execute Script before Reactivation: Whether the pre-reactivation script is executed upon the detection of an error
- Execute Script before Failover: Whether the pre-failover script is executed upon the detection of an error
- Execute Script before Final Action: Whether the pre-final-action script is executed upon the detection of an error
- Recovery Target: Target to be recovered when a problem is detected
- Recovery Target Type: Type of target to be recovered when an error is detected
- Recovery Script Threshold: The number of times the recovery script is executed upon the detection of an error
- Reactivation Threshold: The number of reactivations to be made at detection of an error
- Failover Threshold: The number of failovers to be made at detection of an error
- Wait Time to Start Monitoring (sec): Time to wait before starting monitoring (in seconds)
- Nice Value: Monitor resource nice value
- Monitor Suspended Possibility: Possibility of suspending monitoring

Dummy Failure Possibility	Possibility of Dummy Failure
Collect Dump at Timeout Occurrence:	Whether or not dump of monitor process is collected when timeout occurs
Run Migration Before Run Failover:	Whether or not migration is run before running failover
Action:	Operation at timeout
Open/Close temporary file:	Whether or not to open/close a dummy file
With Writing:	Whether or not to write a dummy file
Size:	Size of writing into a temporary file
Create Temporary Thread:	Whether or not to create a dummy thread

## Understanding multi target monitor resources

The multi target monitor resource monitors more than one monitor resources.

### Notes on multi target monitor resources

- ◆ The multi target monitor resources regard the offline status of registered monitor resources as being an error. For this reason, for a monitor resource that performs monitoring when the target is active is registered, the multi target monitor resource might detect an error even when an error is not detected by the monitor resource. Do not, therefore, register monitor resources that perform monitoring when the target is active.

### Multi target monitor resource status

The status of the multi target monitor resource is determined by the status of registered monitor resources.

The table below describes status of multi target monitor resource when the multi target monitor resource is configured as follows:

The number of registered monitor resources	2
Error Threshold	2
Warning Threshold	1

Multi target monitor resource status		Monitor resource1 status		
		Normal	Error	Offline
Monitor resource2 status	Normal	normal	caution	caution
	Error	caution	error	error
	Offline	caution	error	normal

- ◆ Multi target monitor resource monitors status of registered monitor resources.
  - If the number of the monitor resources with the error status exceeds the error threshold, the status of the multi target monitor resource becomes error.
  - If the number of the monitor resources with the caution status exceeds the caution threshold, the status of the multi target resource becomes caution.
  - If all registered monitor resources are in the status of stopped (offline), the status of multi target monitor resource becomes normal. Unless all the registered monitor resources are stopped (offline), the multi target monitor resource recognizes the stopped (offline) status of a monitor resource as error.
- ◆ If the status of a registered monitor resource becomes error, actions for the error of the monitoring resource are not executed.
  - Actions for error of the multi target monitor resource are executed only when the status of the multi target monitor resource becomes error.

## Example of the multi target monitor resource configuration

- ◆ An example of disk path duplication driver usage  
The status should be indicating an error only when disk devices (for example, /dev/sdb and /dev/sdc) fail at the same time.

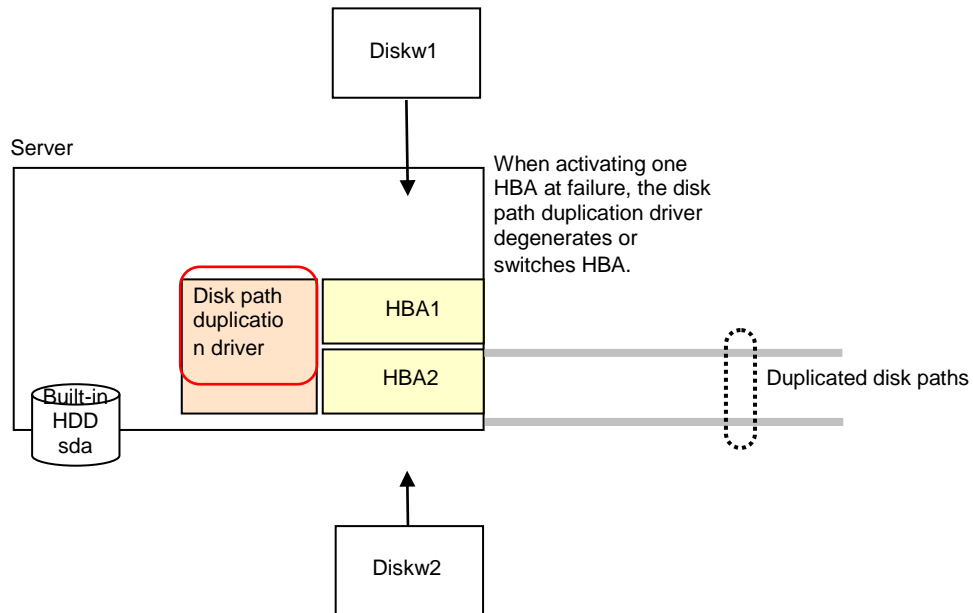

Monitor resources to be registered with the multi target monitor resources (mtw1):

- diskw1
- diskw2

Error Threshold and Warning Threshold of multi target monitor resource (mtw1)

- Error Threshold 2
- Warning Threshold 0

Detailed settings of the monitor resource to be registered with the multi target monitor resource (mtw1)

- Disk monitor resource (diskw1)  
Target Device Name: /dev/sdb  
Reactivation Threshold: 0  
Failover Threshold: 0  
Final Action: No Operation
- Disk monitor resource (diskw2)  
Target Device Name: /dev/sdc  
Reactivation Threshold: 0  
Failover Threshold: 0  
Final Action: No Operation

- ◆ With the settings above, even if either of diskw1 and diskw2, which are registered as monitor resources of the multi target monitor resource detects an error, no actions for the monitor resource having the error are taken.
- ◆ Actions for an error set to the multi target monitor resource are executed when the status of both diskw1 and diskw2 become error, or when the status of two monitor resources become error and offline.

## Displaying and changing the details of the multi target monitor resource

1. Click the **Monitors** icon on the tree view displayed on the left pane of the Builder window.
2. List of monitor resources is displayed in the table view on the right side of the screen. Right-click the multi target monitor resource. Then click **Properties** and select **Monitor(special)** tab.
3. On the **Monitor(special)** tab, you can see and/or change the detailed settings by following the description below.

Monitor resources are grouped and the status of the group is monitored. You can register up to 64 monitor resources in the **Monitor Resources**.

When the only one monitor resource set in the **Monitor Resources** is deleted, the multi target monitor resource is deleted automatically.

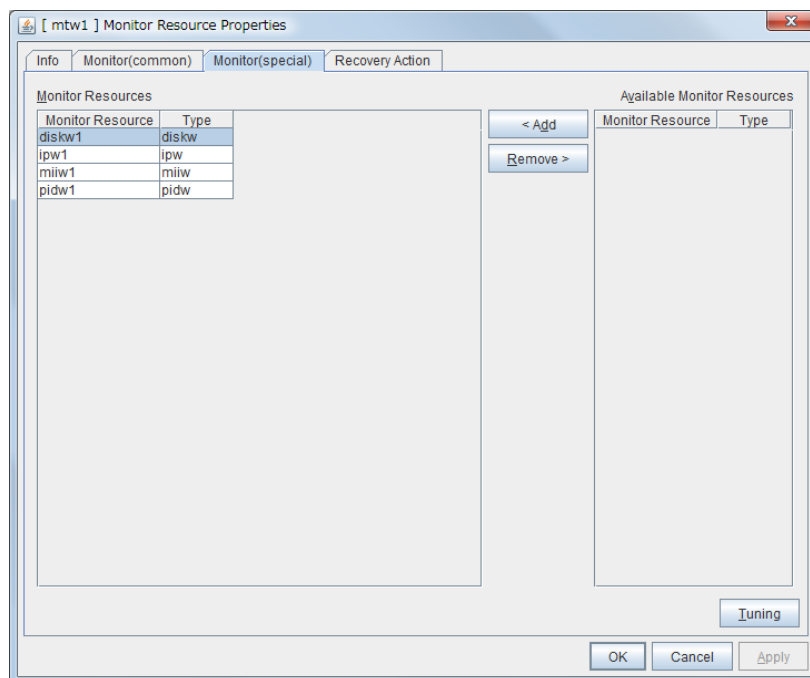

### Add

Click **Add** to add a selected monitor resource to **Monitor Resources**.

### Remove

Click **Remove** to delete a selected monitor resource from **Monitor Resources**.

## Tuning multi target monitor resource

1. From the tree view displayed in the left pane of the Builder, click the Monitors icon.
2. The list of monitor resources is displayed on the table view in the right pane of the window. Right-click the target multi target monitor resource name. Click Monitor(special) and then click Parameters.
3. Click Tuning on the Details tab. The MultiTarget Monitor Resource Tuning Monitor(special) dialog box is displayed.
4. The settings of multi target monitor resource can be displayed and changed by following the description below.

### Parameter tab

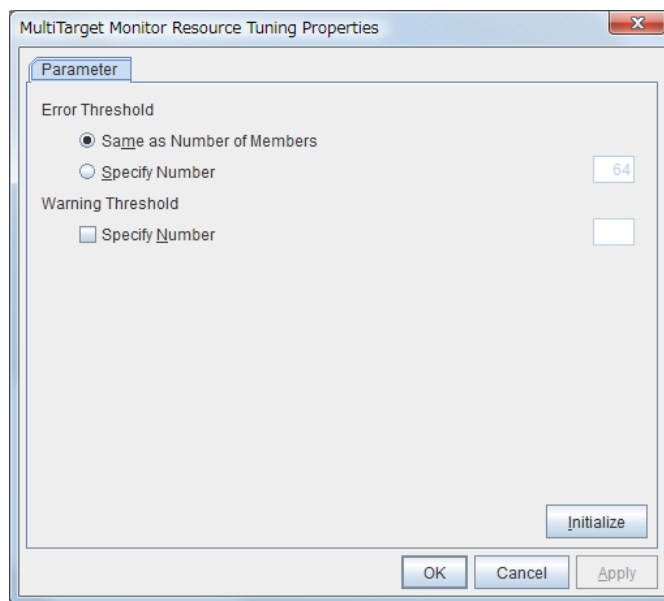

### Error Threshold

Select the condition for multi target monitor resources to be determined as an error.

- ◆ Same as Number of Members

The status of multi target monitor resources becomes “Error” when all monitor resources specified to be under the multi target monitor resource are failed, or when “Error” and “Offline” co-exist.

The status of multi target monitor resources becomes “Normal” when the status of all monitor resources specified to be under the multi target monitor resource are “Offline.”

- ◆ Specify Number

The status of multi target monitor resources becomes “Error” when the number of monitor resources specified in **Error Threshold** becomes “Error” or “Offline.”

When the status of some monitor resources among those specified to be under the multi target monitor resource, specify how many monitor resources need to be “Error” or “Offline” to determine that the status of multi target monitor resource is “Error.”



### **Warning Threshold**

- ◆ When the check box is selected:

When the status of some monitor resources among those specified to be under the multi target monitor resource, specify how many monitor resources need to be “Error” or “Offline” to determine that the status of multi target monitor resource is “Caution.”

- ◆ When the check box is not selected:

Multi target monitor resources do not display an alert.

### **Initialize**

Clicking **Initialize** resets all items to their default values.

## Displaying the property of the multi target monitor resource with the WebManager

1. Start the WebManager
2. When you click an object for a multi target monitor resource  in the tree view, the following information is displayed in the list view.

Multi Target Monitor Name: mtw1		Details
<span>Common</span> <span>server1</span> <span>server2</span>		
Properties	Value	
Comment		
Monitor Resources	diskw1	
	ipw1	
	miw1	
	pidw1	
Status	Normal	
Resource Status on Each Server		
Server Name	Status	
server1	Normal	
server2	Normal	

Comment:	Comment of the multi target monitor resource
Monitor Resources:	List of monitor resources
Status:	Multi target monitor resource status
Server Name:	Server name
Status:	Status of the monitor resource on the server

When you click **Details**, the following information is displayed in the pop-up dialog box:

Properties	Value
Name	mtw1
Type	rntw
Monitor Timing	Always
Target Resource	
Interval (sec)	30
Timeout (sec)	30
Do Not Retry at Timeout Occurrence	Off
Do Not Execute Recovery Action at Timeout Occurrence	Off
Retry Count	0
Final Action	No operation
Execute Script Before Reactivation	Off
Execute Script Before Failover	Off
Execute Script before Final Action	Off
Recovery Target	LocalServer
Recovery Target Type	Itself
Recovery Script Threshold	0
Reactivation Threshold	0
Failover Threshold	0
Wait Time to Start Monitoring (sec)	0
Nice Value	0
Monitor Suspend Possibility	Possible
Dummy Failure Possibility	Possible
Collect Dump at Timeout Occurrence	Off
Run Migration Before Run Failover	Off

Name:	Multi target monitor resource name
Type:	Monitor resource type
Monitor Timing:	Timing to start monitoring
Target Resource:	Resource to be monitored
Interval (sec):	Interval between monitoring (in seconds)
Timeout (sec):	Timeout for monitoring (in seconds)
Do Not Retry at Timeout Occurrence:	Whether or not to retry when timeout occurs
Do Not Execute Recovery Action at Timeout Occurrence:	Whether or not to execute recovery action when timeout occurs
Retry Count:	The number of retries to be made from detection of an error in the monitor target to establish the error as error
Final Action:	Final action at detection of an error
Execute Script before Reactivation:	Whether the pre-reactivation script is executed upon the detection of an error
Execute Script before Failover:	Whether the pre-failover script is executed upon the detection of an error
Execute Script before Final Action:	Whether the pre-final-action script is executed upon the detection of an error
Recovery Target:	Target to be recovered when an error is detected
Recovery Target Type:	Type of target to be recovered when an error is detected
Recovery Script Threshold:	The number of times the recovery script is executed upon the detection of an error
Reactivation Threshold:	The number of reactivations to be made at detection of an error
Failover Threshold:	The number of failovers to be made at detection of an error
Wait Time to Start Monitoring (sec):	Time to wait before starting of monitoring (in seconds)
Nice Value:	Monitor resource nice value
Monitor Suspended Possibility:	Possibility of suspending monitoring
Dummy Failure Possibility:	Possibility of Dummy Failure
Collect Dump at Timeout Occurrence:	Whether or not dump of monitor process is collected when timeout occurs
Run Migration Before Run Failover:	Whether or not migration is run before running failover

## Understanding virtual IP monitor resources

### Note on virtual IP monitor resources

Detailed settings are not required for virtual IP monitor resources.

Use the resources when using virtual IP resources of EXPRESSCLUSTER.

- ◆ Virtual IP monitor resource is created automatically when the virtual IP resource is created. One virtual IP monitor resource is created per virtual IP resource automatically.
- ◆ Virtual IP monitor resource cannot be deleted. It is deleted automatically at deletion of a virtual IP resource.
- ◆ Do not change the recovery target.
- ◆ Monitoring cannot be suspended or resumed by the `clpmonctrl` command or the WebManager.
- ◆ Virtual IP monitor resource regularly sends RIP packets to control a path of the virtual IP resource. If the target virtual IP resource is active while the cluster is suspended, the virtual IP monitor resource continues operating.
- ◆ The setting of Monitor(common) tab-Retry Count is invalid. When you'd like to delay error detection, please change the setting of Monitor(common) tab-Timeout.

### Setting virtual IP monitor resources

Virtual IP monitor resource sends packets for dynamic routing of the routing table the virtual IP resource requires. The status of IP addresses activated by the virtual IP resources is not checked. There is no detailed setting for the virtual IP monitor resource.

## Displaying the virtual IP monitor resource property with the WebManager

1. Start the WebManager.
2. When you click an object for a virtual IP monitor resource  in the tree view, the following information is displayed in the list view.

VIP Monitor Name: vipw1		Details	
Common		server1	server2
Properties	Value		
Comment			
Monitor Target	vip1		
Status	Normal		
Resource Status on Each Server			
Server Name	Status		
server1	Normal		
server2	Offline		

Comment:

Monitor Target:

Status:

Server Name:

Status:

Comment

The name of a Virtual IP resource to be monitored

Status of virtual IP monitor resource

Server name

Status of monitor resource of the server

When you click **Details**, the following information is displayed in the pop-up dialog box:

Properties	Value
Name	vipw1
Type	vipw
Monitor Timing	Activating
Target Resource	vip1
Interval (sec)	3
Timeout (sec)	30
Do Not Retry at Timeout Occurrence	Off
Do Not Execute Recovery Action at Timeout Occurrence	Off
Retry Count	0
Final Action	No operation
Execute Script Before Reactivation	Off
Execute Script Before Failover	Off
Execute Script before Final Action	Off
Recovery Target	vip1
Recovery Target Type	Resource
Recovery Script Threshold	0
Reactivation Threshold	3
Failover Threshold	1
Wait Time to Start Monitoring (sec)	0
Nice Value	0
Monitor Suspend Possibility	Impossible
Dummy Failure Possibility	Impossible
Collect Dump at Timeout Occurrence	Off
Run Migration Before Run Failover	Off

Name:	Virtual IP monitor resource name
Type:	Monitor resource type
Monitor Timing:	Timing to start monitoring
Target Resource:	Virtual IP resource name to be monitored
Interval (sec):	Interval between monitoring (in seconds)
Timeout (sec):	Timeout for monitoring (in seconds)
Do Not Retry at Timeout Occurrence:	Whether or not to retry when timeout occurs
Do Not Execute Recovery Action at Timeout Occurrence:	Whether or not to execute recovery action when timeout occurs
Retry Count:	The number of retries to be made from detection of an error in the monitor target to establish the error as an error
Final Action:	Final action at detection of an error
Execute Script before Reactivation:	Whether the pre-reactivation script is executed upon the detection of an error
Execute Script before Failover:	Whether the pre-failover script is executed upon the detection of an error
Execute Script before Final Action:	Whether the pre-final-action script is executed upon the detection of an error
Recovery Target:	Target to be recovered when an error is detected
Recovery Target Type:	Type of target to be recovered when an error is detected
Recovery Script Threshold:	The number of times the recovery script is executed upon the detection of an error
Reactivation Threshold:	The number of reactivations to be made at detection of an error
Failover Threshold:	The number of failovers to be made at detection of an error
Wait Time to Start Monitoring (sec):	Time to wait before starting monitoring (in seconds)
Nice Value:	Monitor resource nice value
Monitor Suspend Possibility:	Possibility of suspending monitoring
Dummy Failure Possibility:	Possibility of Dummy Failure
Collect Dump at Timeout Occurrence:	Whether or not dump of monitor process is collected when timeout occurs

Run Migration Before Run Failover: Whether or not migration is run before running failover

## Understanding ARP monitor resources

ARP monitor resource sends ARP packets regularly to maintain and update the ARP table for active floating IP resources or virtual IP resources.

### Note on ARP monitor resources

For details on the ARP broadcast packets that ARP monitor resource sends, see “Understanding floating IP resource” of Chapter 4, “Group resource details” in this guide.

The status of the IP address activated by floating IP resource or virtual IP resource is not checked.

Only floating IP resource or virtual IP resource can be selected as a target monitoring resource of ARP monitor resource. On the ARP monitor resource setting, make sure to select a same resource for **Target Resource** on the **Monitor(common)** tab and **Target Resource** on the **Monitor(special)** tab.

Monitoring of the ARP monitor resource cannot be suspended or resumed by the `clpmonctrl` command or by the WebManager.



## Displaying and changing the ARP monitor resource details

1. Click the **Monitors** icon on the tree view displayed on the left side of the Builder window.
2. List of the monitor resources is displayed in the table view on the right side of the screen. Right-click the name of the target ARP monitor resource, and click the **Monitor(special)** tab in the **Monitor Resource Property** window.
3. On the **Monitor(special)** tab, you can see and/or change the detailed settings by following the description below.

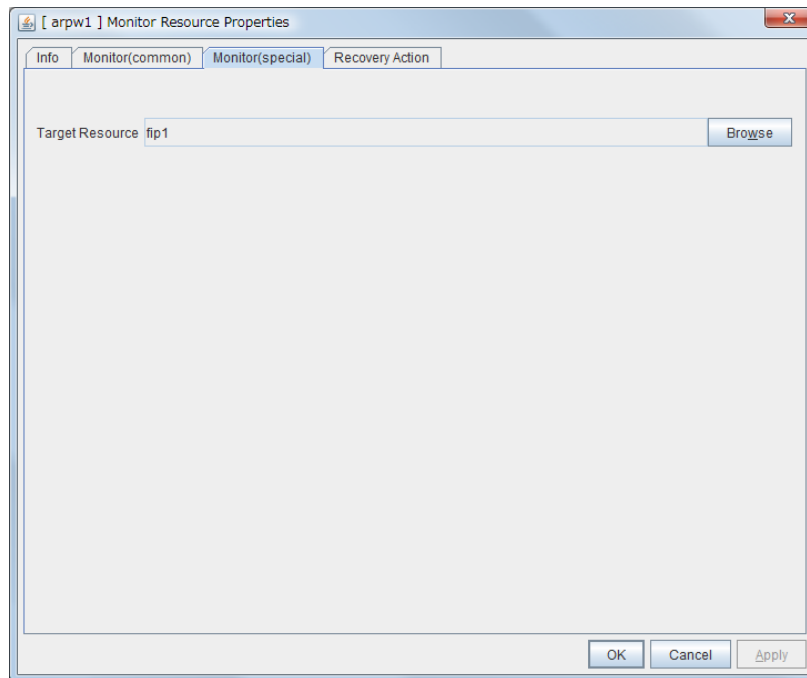

### Target Resource

Click **Browse** to display the dialog box to select a target resource. The names of groups, floating IP resources and virtual IP resources registered to a LocalServer and cluster are displayed in the tree view. Select the resource you want to set as a target resource, and then click **OK**.

---

### Note:

When you change the target resource, make sure to change the one configured on the **Monitor(common)** tab.

---

## Displaying the ARP monitor resource property with the WebManager

1. Start the WebManager.
2. When you click an object for an ARP monitor resource  in the tree view, the following information is displayed in the list view.

ARP Monitor Name: arpw1		Details
<div style="display: flex; border-bottom: 1px solid black;"> <span style="border: 1px solid black; padding: 2px 5px;">Common</span> <span style="border: 1px solid black; padding: 2px 5px; margin-left: 5px;">server1</span> <span style="border: 1px solid black; padding: 2px 5px; margin-left: 5px;">server2</span> </div>		
Properties	Value	
Comment		
Monitor Target	fip1	
Status	Normal	
Resource Status on Each Server		
Server Name	Status	
server1	Normal	
server2	Offline	

Comment:

Comment on the ARP monitor resource

Monitor Target:

The name of a resource to be monitored

Status:

ARP monitor resource status

Server Name:

Server name

Status:

Status of the monitor resource on the server

When you click **Details**, the following information is displayed in the pop-up dialog box:

Properties	Value
Name	arpw1
Type	arpw
Monitor Timing	Activating
Target Resource	fip1
Interval (sec)	30
Timeout (sec)	180
Do Not Retry at Timeout Occurrence	Off
Do Not Execute Recovery Action at Timeout Occurrence	Off
Retry Count	0
Final Action	No operation
Execute Script Before Reactivation	Off
Execute Script Before Failover	Off
Execute Script before Final Action	Off
Recovery Target	LocalServer
Recovery Target Type	Itself
Recovery Script Threshold	0
Reactivation Threshold	0
Failover Threshold	0
Wait Time to Start Monitoring (sec)	0
Nice Value	0
Monitor Suspend Possibility	Impossible
Dummy Failure Possibility	Impossible
Collect Dump at Timeout Occurrence	Off
Run Migration Before Run Failover	Off

- Name: ARP monitor resource name
- Type: Monitor resource type
- Monitor Timing: Timing to start monitoring
- Target Resource: Resource to be monitored
- Interval (sec): Interval between monitoring (in seconds)
- Timeout (sec): Timeout for monitoring (in seconds)
- Do Not Retry at Timeout Occurrence: Whether or not to retry when timeout occurs
- Do Not Execute Recovery Action at Timeout Occurrence: Whether or not to execute recovery action when timeout occurs
- Retry Count: The number of retries to be made from detection of an error in the monitor target to establish the error as an error
- Final Action: Final action at detection of an error
- Execute Script before Reactivation: Whether the pre-reactivation script is executed upon the detection of an error
- Execute Script before Failover: Whether the pre-failover script is executed upon the detection of an error
- Execute Script before Final Action: Whether the pre-final-action script is executed upon the detection of an error
- Recovery Target: Target to be recovered when an error is detected
- Recovery Target Type: Type of target to be recovered when an error is detected
- Recovery Script Threshold: The number of times the recovery script is executed upon the detection of an error
- Reactivation Threshold: The number of reactivations to be made at detection of an error
- Failover Threshold: The number of failovers to be made at detection of an error
- Wait Time to Start Monitoring (sec): Time to wait before starting monitoring (in seconds)
- Nice Value: Monitor resource nice value
- Monitor Suspend Possibility: Possibility of suspending monitoring
- Dummy Failure Possibility: Possibility of Dummy Failure
- Collect Dump at Timeout Occurrence: Whether or not dump of monitor process is collected when timeout occurs

Run Migration Before Run Failover: Whether or not migration is run before running failover

# Understanding custom monitor resources

Custom monitor resources monitor system by executing an arbitrary script.

## Notes on custom resources

When the monitor type is **Asynchronous**, and the monitoring retry count is set to 1 or more, monitoring cannot be performed correctly. When you set the monitor type to **Asynchronous**, also specify 0 as the monitoring retry count.

EXPRESSCLUSTER X3.0.4-1 and earlier versions allowed the monitor resource monitoring setting **Collect the dump file of the monitor process at timeout occurrence** to be configured, but this function did not provide sufficient useful information for custom monitor resources. Therefore, this function has been dropped from EXPRESSCLUSTER X3.1 and later versions from those configurable for custom monitor resources.

To use an alternative logging function, specify **Log Output Path** for custom monitor resources to output logs.

When Script Log Rotate is enabled, the logs are written to the specified file after the script finishes. If the monitor type is set to **Asynchronous**, the script does not finish and the logs are not written. Therefore, it is recommended that you disable **Script Log Rotate**. If the monitor type is set to **Synchronous**, redirect the standard output of the resident process started in the start script to /dev/null.

## Monitoring by custom monitor resources

Custom monitor resources monitor system by an arbitrary script.

When Monitor Type is **Synchronous**, custom monitor resources regularly run a script and detect errors from its error code.

When Monitor Type is **Asynchronous**, custom monitor resources run a script upon start monitoring and detect errors if the script process disappears.

## Displaying and changing the details of the custom monitoring resources

1. Click Monitors on the tree view displayed on the left side of the Builder window.
2. List of the monitor resources is displayed in the table view on the right side of the screen. Right click the target custom monitor resource, and click the **Monitor(special)** tab in the **Monitor Resource Property** window.
3. On the **Monitor(special)** tab, you can display and/or change the detailed settings by following the description below.

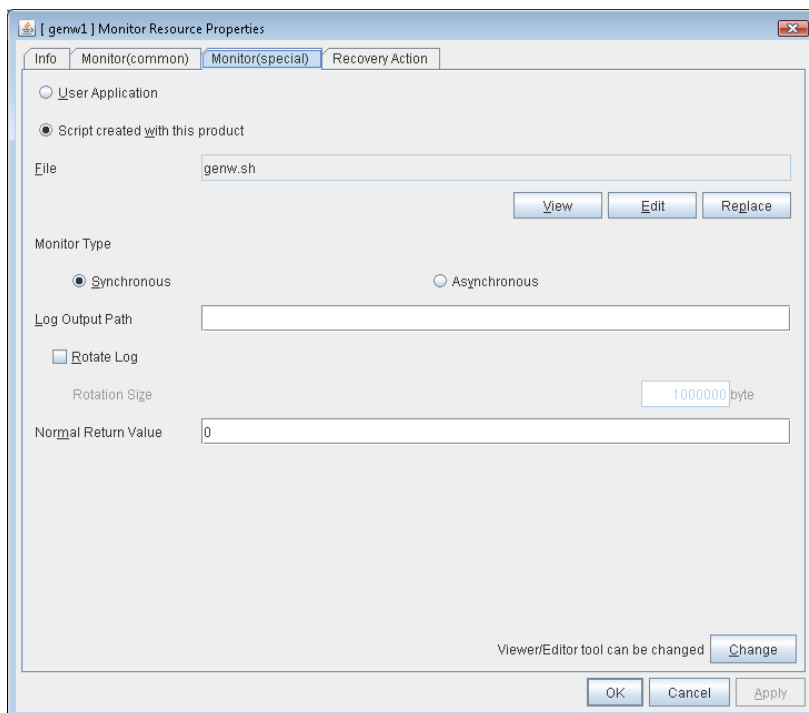

### User Application

Use an executable file (executable shell script file or execution file) on the server as a script. For the file name, specify an absolute path or name of the executable file of the local disk on the server.

Each executable files is not included in the cluster configuration information of the Builder. They must be prepared on each server because they cannot be edited nor uploaded by the Builder.

### Script created with this product

Specify a script file which is prepared by the Builder as a script with an absolute path of local disk on server.

**File** (Within 1023 bytes)

Specify the script to be executed (executable shell script file or execution file) when you select User Application with its absolute path on the local disk of the server.

**View**

Click here to display the script file with an editor when you select **Script created with this product**. The information edited and stored with the editor is not applied. You cannot display the script file if it is currently displayed or edited.

**Edit**

Click here to edit the script file with the editor when you select **Script created with this product**. Overwrite the script file to apply the change. You cannot edit the script file if it is currently displayed or edited. You cannot modify the name of the script file.

**Replace**

Click here to replace the contents of a script file with the contents of the script file which you selected in the file selection dialog box when you select **Script created with this product**. You cannot replace the script file if it is currently displayed or edited. Select a script file only. Do not select binary files (applications), and so on.

**Change**

Click here to display the **Change Script Editor** dialog. You can change editor for displaying or editing a script to an arbitrary editor.

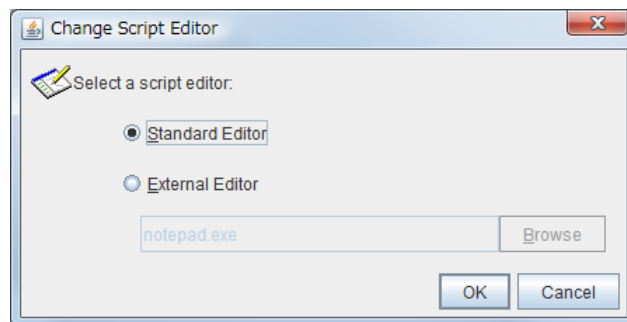
**Standard Editor**

Select this option to use the standard editor for editing scripts.

- Linux: vi (vi which is detected by the user's search path)
- Windows: Notepad (notepad.exe which is detected by the user's search path)

**External Editor**

Select this option to specify a script editor. Click **Browse** to select an editor.

To specify a CUI-based external editor on Linux, create a shell script.

The following is a sample shell script to run vi:

```
xterm -name clpedit -title " Cluster Builder " -n " Cluster Builder"
-e vi "$1"
```

**Monitor Type**

Select a monitor type.

- ◆ Synchronous (Default)
  - Custom monitor resources regularly run a script and detect errors from its error code.
- ◆ Asynchronous
  - Custom monitor resources run a script upon start monitoring and detect errors if the script process disappears.

**Log Output Path** (Within 1023 bytes)

Specify log output path for the script of custom monitor resource.

Pay careful attention to the free space in the file system because the log is output without any limitations when the file name is specified and the **Rotate Log** check box is unchecked.

When the **Rotate Log** check box is selected, output log files are rotated.

**Rotate Log**

Turn this off to output execution logs of scripts and executable files with no limit on the file size. Turn it on to rotate and output the logs. In addition, note the following.

Enter the log path in 1009 bytes or less in Log Output Path. If the path exceeds 1009 bytes, the logs are not output.

The log file name must be 31 bytes or less. If the name exceeded 32 bytes, the logs are not output.

If some custom monitor resources are configured to rotate logs, and the log file names are the same but the log paths are different, the Log Rotate Size may be incorrect.

(for example, /home/foo01/log/genw.log, /home/foo02/log/genw.log)

**Rotation Size** (1 to 9999999)

Specify a file size for rotating files when the **Rotate Log** check box is selected.

The log files that are rotated and output are configured as described below.

File name	Description
<b>Log Output Path</b> <i>specified_file_name</i>	Latest log file.
<b>Log Output Path</b> <i>specified_file_name.pre</i>	Former log file that has been rotated.



**Normal Return Value** (Within 1023 bytes)

When **Asynchronous** is selected for **Monitor Type**, set the values of script error code to be determined as normal. If you want to set two or more values here, separate them by commas like 0,2,3 or connect them with a hyphen to specify the range like 0-3.

Default value: 0

## Displaying the custom monitor resource properties with the Web Manager

1. Start the WebManager  
 (*http://FIP\_address\_for\_the\_WebManager\_group: port\_number* (the default value is 29003)).
2. Click a custom monitor resources object, , in the tree view. The following information is displayed in the list view.

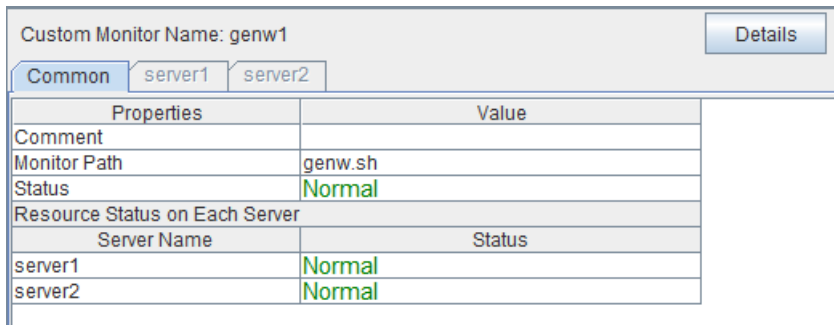

Custom Monitor Name: genw1		Details
Common		server1
server2		
Properties	Value	
Comment		
Monitor Path	genw.sh	
Status	Normal	
Resource Status on Each Server		
Server Name	Status	
server1	Normal	
server2	Normal	

Comment: Comment of the custom monitor resource  
 Monitor Path: Path to the monitor script  
 Status: Custom monitor resource status

Server Name: Server name  
 Status: Status of the monitor resource on the given server

When you click **Details**, the following information is displayed in the pop-up dialog box:

Properties	Value
Name	genw1
Type	genw
Monitor Timing	Always
Target Resource	
Interval (sec)	60
Timeout (sec)	120
Do Not Retry at Timeout Occurrence	Off
Do Not Execute Recovery Action at Timeout Occurrence	Off
Retry Count	0
Final Action	No operation
Execute Script Before Reactivation	Off
Execute Script Before Failover	Off
Execute Script before Final Action	Off
Recovery Target	LocalServer
Recovery Target Type	Itself
Recovery Script Threshold	0
Reactivation Threshold	0
Failover Threshold	0
Wait Time to Start Monitoring (sec)	0
Nice Value	0
Monitor Suspend Possibility	Possible
Dummy Failure Possibility	Possible
Collect Dump at Timeout Occurrence	Off
Run Migration Before Run Failover	Off
Monitor Type	Synchronous
Log Output Path	
Script Log Rotate	Off
Script Log Rotate Size (byte)	1000000
Script Log Rotate Generation	2

- Name: Custom monitor resource name
- Type: Monitor resource type
- Monitor Timing: Timing for the monitor resource to start monitoring
- Target Resource: Resource to be monitored
- Interval(sec): Interval between monitoring (in seconds)
- Timeout(sec): Timeout for monitoring (in seconds)
- Do Not Retry at Timeout Occurrence: Whether or not to retry when timeout occurs
- Do Not Execute Recovery Action at Timeout Occurrence: Whether or not to execute recovery action when timeout occurs
- Retry Count: The number of retries to be made from detection of an error in the monitor target to establish the error as error
- Final Action: Final action at detection of an error
- Execute Script before Reactivation: Whether the pre-reactivation script is executed upon the detection of an error
- Execute Script before Failover: Whether the pre-failover script is executed upon the detection of an error
- Execute Script before Final Action: Whether the pre-final-action script is executed upon the detection of an error
- Recovery Target: Target to be recovered when an error is detected
- Recovery Target Type: Type of target to be recovered when an error is detected
- Recovery Script Threshold: The number of times the recovery script is executed upon the detection of an error
- Reactivation Threshold: The number of times activation is retried when an activation error is detected
- Failover Threshold: The number of failovers to be made at detection of an error
- Wait Time to Start Monitoring(sec): Time to wait before start monitoring (in seconds)
- Nice Value: Monitor resource nice value
- Monitor Suspend Possibility: Possibility of suspending monitoring

Dummy Failure Possibility	Possibility of Dummy Failure
Collect Dump at Timeout Occurrence:	Whether or not dump of monitor process is collected when timeout occurs
Run Migration Before Run Failover:	Whether or not migration is run before running failover
Monitor Type:	Execution method of monitor type
Log Output Path:	Script execution log type for log output destination
External File Output Path:	External file output destination when a script is executed
Script Log Rotate	Whether Script Log Rotate is executed
Script Log Rotate Size (byte)	Script Log Rotate size (byte)
Script Log Rotate Generation	Script Log Rotate generation number

## Understanding volume manager monitor resources

Volume manager monitor resources are used to monitor logical disks managed by the volume manager.

### Notes on volume manager monitor resources

When the volume manager is VxVM, volmgrw uses the daemon monitoring method. Therefore, registering multiple items in a single cluster is meaningless.

When specifying VxVM as the volume manager, do not specify the recovery target.

Volume manager monitor resources are automatically registered when a volume manager resource is added. Volume manager monitor resources are automatically registered to the volume manager resource.

Volume manager monitor resources are configured with their default settings; change the settings as needed. Registering the volmgr resource does not automatically register the volmgrw monitor. The volmgrw monitor must be registered manually.

When monitoring the LVM by using the volume manager monitor resource in an environment of Red Hat Enterprise Linux 7 or later, the LVM metadata daemon must be disabled.

### Monitoring by volume manager monitor resources

The monitoring method used by volume manager monitor resources depends on the type of volume manager that manages the target logical disks.

The following volume managers are supported:

- ◆ lvm (LVM volume group)
- ◆ vxvm (VxVM daemon)

## Displaying and changing the details of the volume manager monitor resources

1. Click the **Monitors** icon in the tree view on the left side of the Builder window.
2. The list of monitor resources is shown in the table view on the right side of the screen. Right-click the target volume manager monitor resource name, and then click the **Monitor(special)** tab in **Property**.
3. On the **Monitor(special)** tab, you can display or change detailed settings by following the description below.

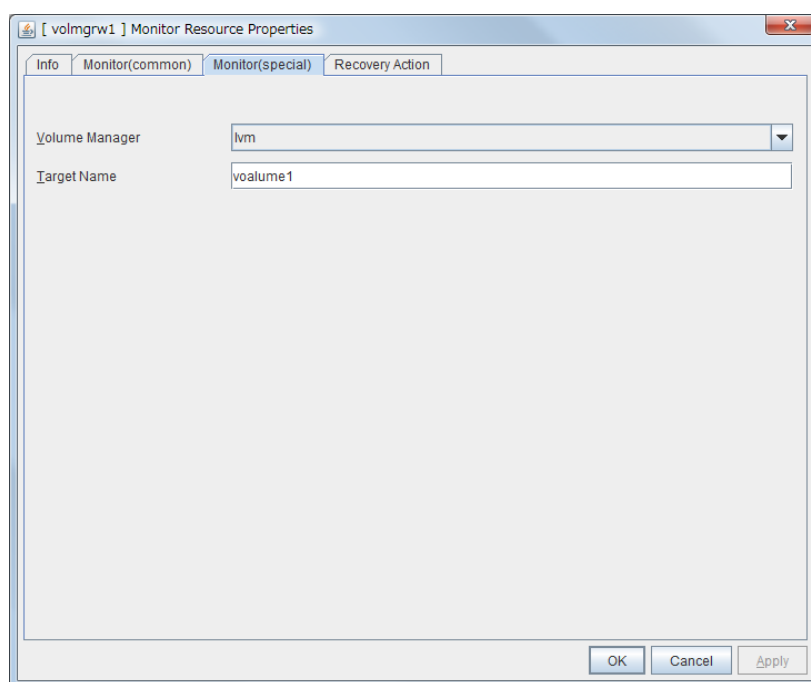

### Volume Manager

Specify the type of volume manager that manages the monitor target logical disks. The following volume managers are supported:

- ◆ lvm (LVM volume group)
- ◆ vxvm (VxVM daemon)

### Target Name(within 1023 bytes)

Specify the name of the monitor target in the <VG name> format (only the target name is used).

When the volume manager is lvm, it's possible to control multiple volumes together.

More than one volume is delimited with an one-byte space.

When the volume manager is vxvm, this setting need not be entered.

## Displaying the properties of a volume manager monitor resource by using the WebManager

1. Start the WebManager.
2. In the tree view, click the object icon  for a volume manager monitor resource. The following information is displayed in the list view:

Volume Manager Monitor Name: volmgrw1		Details
Common server1 server2		
Properties	Value	
Comment		
Volume Manager	lvm	
Target	volume1	
Status	Normal	
Resource Status on Each Server		
Server Name	Status	
server1	Normal	
server2	Offline	

Comment:	Comment on the volume manager monitor resource
Volume Manager:	Type of volume manager that manages the monitor target logical disk
TargetName:	Name of the monitor target
Server Name:	Server name
Status:	Status of the monitor resources on each server

When you click **Details**, the following information is displayed in the pop-up dialog box:

Properties	Value
Name	volmgrw1
Type	volmgrw
Monitor Timing	Activating
Target Resource	volmgr1
Interval (sec)	60
Timeout (sec)	120
Do Not Retry at Timeout Occurrence	Off
Do Not Execute Recovery Action at Timeout Occurrence	Off
Retry Count	1
Final Action	Stop the cluster service and shutdown OS
Execute Script Before Reactivation	Off
Execute Script Before Failover	Off
Execute Script before Final Action	Off
Recovery Target	volmgr1
Recovery Target Type	Resource
Recovery Script Threshold	0
Reactivation Threshold	0
Failover Threshold	1
Wait Time to Start Monitoring (sec)	0
Nice Value	0
Monitor Suspend Possibility	Possible
Dummy Failure Possibility	Possible
Collect Dump at Timeout Occurrence	Off
Run Migration Before Run Failover	Off

**Name:** Volume manager monitor resource name  
**Type:** Monitor resource type  
**Monitor Timing:** Monitor resource monitoring start time  
**Target Resource:** Monitor target resource  
**Interval(sec):** Interval between monitor target status checks (in seconds)  
**Timeout(sec):** Timeout for monitoring (in seconds)  
**Do Not Retry at Timeout Occurrence:** Whether or not to retry when timeout occurs  
**Do Not Execute Recovery Action at Timeout Occurrence:** Whether or not to execute recovery action when timeout occurs  
**Retry Count:** Retry count used to determine that the monitor resource has an error after detecting a monitor target error  
**Final Action:** Final action when an error is detected  
**Execute Script before Reactivation:** Whether the pre-reactivation script is executed upon the detection of an error  
**Execute Script before Failover:** Whether the pre-failover script is executed upon the detection of an error  
**Execute Script before Final Action:** Whether the pre-final-action script is executed upon the detection of an error  
**Recovery Target:** Recovery target when an error is detected  
**Recovery Target Type:** Recovery target type when an error is detected  
**Recovery Script Threshold:** The number of times the recovery script is executed upon the detection of an error  
**Reactivation Threshold:** Reactivation count when an error is detected  
**Failover Destination Server:** Failover destination determination method  
**Failover Threshold:** Failover count when an error is detected  
**Wait Time to Start Monitoring l(sec):** Wait time until monitoring starts (in seconds)  
**Nice Value:** Nice value of the monitor resource  
**Monitor Suspend Possibility:** Possibility of pausing monitor resource monitoring  
**Dummy Failure Possibility:** Possibility of Dummy Failure



Collect Dump at Timeout Occurrence: Whether or not dump of monitor process is collected when timeout occurs

Run Migration Before Run Failover: Whether or not migration is run before running failover

## Understanding message receive monitor resources

Message receive monitor resources are passive monitors. They do not perform monitoring by themselves.

When an error message issued using the `clprexec` command is received from outside of EXPRESSCLUSTER, the message receive monitor resources change their status and perform recovery from the error.

### Monitoring by message receive monitor resources

- When an error message is received from an outside source, the resource recovers the message receive monitor resource whose Category and Keyword have been reported. (The Keyword can be omitted.)  
If there are multiple message receive monitor resources whose monitor types and monitor targets have been reported, each monitor resource is recovered.
- Message receive monitors can receive error messages issued by the `clprexec` command, local server BMC, and expanded device drivers within the server management infrastructure.
- I/O Fencing completion notification from BMC is supported only by the NX7700x series. For details, see “NX7700x series linkage”, starting on page 1249.
- Error messages from local server BMC are available only in Express5800/A1080a or Express5800/A1040a series linkage. For details, see “Express5800/A1080a or Express5800/A1040a series linkage”, starting on page 1250.
- For details on the monitoring method that uses linkage with server management infrastructure, see Chapter 9, “Linkage with Server Management Infrastructure”, starting on page 1267.

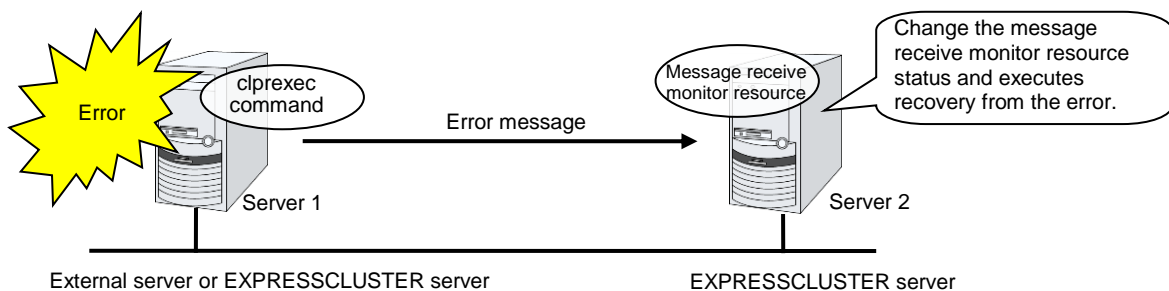

## Failover to outside the server group

- Upon the reception of notification of the occurrence of an error, failover from the active server group to another server group is allowed.
- The following server group and other settings must be specified.
  - Group resource for recovery
    - [Use Server Group Settings] is selected
  - Message receive monitor
    - [Execute failover to the recovery target] is specified for the recovery target
    - [Execute Failover outside the Server Group] is selected
- Upon the execution of server group failover to outside the server group, the dynamic failover settings and inter-server group failover settings are disabled. The server fails over to the server having the highest priority in a server group other than that to which it belongs.

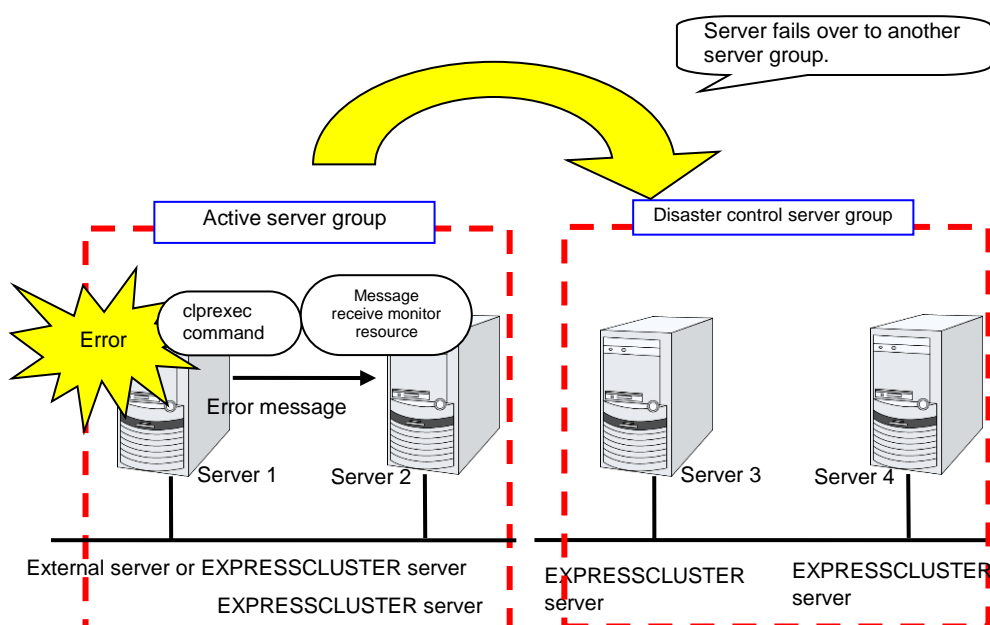

## Notes on message receive monitor resources

### Notes on message receive monitor resources

- ◆ If a message receive monitor resource is paused when an error message is received from outside, error correction is not performed.
- ◆ If an error message is received from outside, the status of the message receive monitor resource becomes "error". The error status of the message receive monitor resource is not automatically restored to "normal". To restore the status to normal, use the `clprexec` command. For details about this command, see “Requesting processing to cluster servers (`clprexec` command)” in Chapter 3, “EXPRESSCLUSTER command reference” in this guide.
- ◆ If an error message is received when the message receive monitor resource is already in the error status due to a previous error message, recovery from the error is not performed.
- ◆ When the recovery action is **Executing failover to outside the Server Group**, and if **Execute Failover to outside the Server Group** is selected, the server always fails over to a server in a server group other than the active server group. If, however, the above-mentioned settings are configured but the server group is not configured, the failover destination is determined according to the ordinary failover policy.

### Notes on using the NX7700x series linkage function

- ◆ The hardware and firmware installed on the server must support this function. In addition, the ipmi server must be started. For details on the models that support this function, refer to “Servers supporting NX7700x series linkage” in Chapter 3, “Installation requirements for EXPRESSCLUSTER” in the *Getting Started Guide*.
- ◆ To receive an I/O Fencing completion notification from the BMC, the management LAN port of the BMC must be capable of communicating with the NIC of the OS. Specify a port number by connecting the SNMP Trap-receiving IP addresses of all servers with ; (semicolon). The port number can be omitted (defaults to 162). If it is necessary to set a port number, it must be entered at the end of the IP address, after : (colon).

Example: 192.168.0.1;192.168.0.2;192.168.0.3:162

### Notes on using the Express5800/A1080a or Express5800/A1040a series linkage function

- ◆ To enable the reception of error messages from BMC, the hardware and firmware on the server must be configured accordingly. The IPMI service must also be activated. For details on supported hardware, see "Servers supporting Express5800/A1080a or Express5800/A1040a series -related functions" in Chapter 3 in the *Getting Started Guide*.
- ◆ To enable the reception of error messages from BMC, communication from the BMC network interface to the OS network interface must be secured.
- ◆ To enable the reception of error messages from BMC, specify the IP address for SNMP trap reception and the port number for the server by using server-specific settings. The port number can be omitted (defaults to 162). Configure the same port number for all message receive monitor resources on the server if explicitly specified.

### Notes on using linkage with server management infrastructure

- ◆ If the Enterprise Linux with Dependable Support server management infrastructure is linked, the settings for and operation of the message receive monitor resources will differ. If linking with the server management infrastructure, see Chapter 9, “Linkage with Server Management Infrastructure” on the pages from 1267.

## Displaying and changing the details of the message receive monitor resources

1. Click a monitor resource icon in the tree view on the left side of the Builder window.
2. The list of monitor resources is shown in the table view on the right side of the screen. Right-click the target message receive monitor resource, and then click the **Monitor(special)** tab in the **Monitor Resource Property** window.
3. On the **Monitor(special)** tab, you can display or change detailed settings by following the description below.

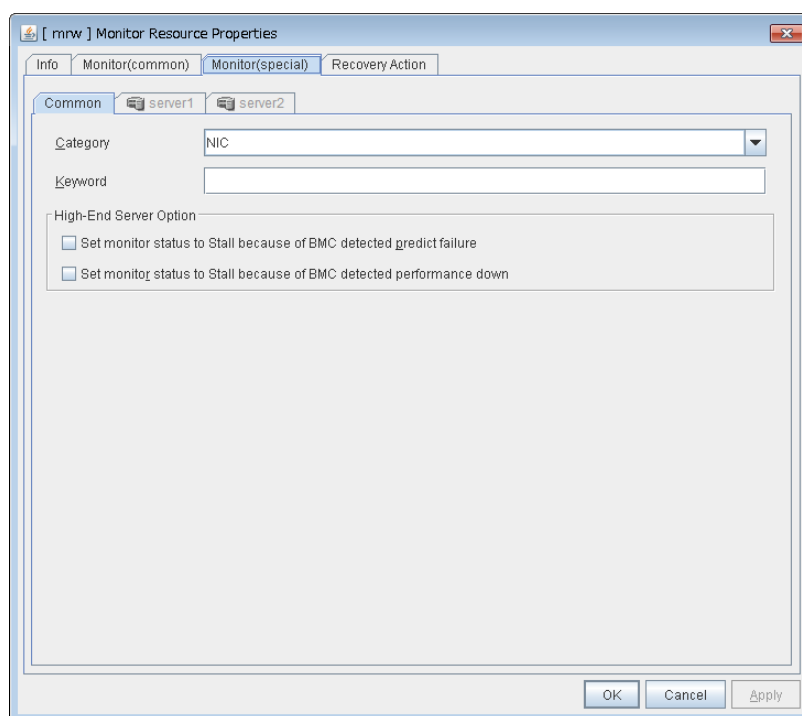

For **Category** and **Keyword**, specify a keyword passed using the -k parameter of the clprexec command. The keyword can be omitted.

### **Category** (within 32 bytes)

Specify a monitor type. To monitor error messages from BMC (SNMP Trap), specify BMCNOTICE.

You can select the default character string from the list box or specify any character string.

### **Keyword** (within 1023 bytes)

Specify a keyword passed using the -k parameter of the clprexec command. When BMCNOTICE is specified for the category, specify the IP address for SNMP trap reception and the port number for each server by using server-specific settings. The port number can be omitted (defaults to 162). Configure the same port number for all the message receive monitor resources for each server if explicitly specified. The specification format is as described below:

```
<IP_address>[:<port_number>]
```

<Only NX7700x series >

To receive an I/O fencing completion notification, specify BMCNOTICE for the category and specify the SNMP Trap-receiving IP address of all the servers and the port number. The port number can be omitted (defaults to 162). If a port number is set, however, it will be common to all the external linkage monitors. The format is as shown below.

```
<IP_address>;<IP_address>;...(up to 32) ...;<IP_address>[:<port_number>]
```

**Set monitor status to Stall because of BMC detected predict failure**

This cannot be used.

**Set monitor status to Stall because of BMC detected performance down**

This cannot be used.

## Displaying and changing the error detection settings of the message receive monitor resources

1. Click a monitor resource icon in the tree view on the left side of the Builder window.
2. The list of monitor resources is shown in the table view on the right side of the screen. Right-click the target monitor resource name, and then click the **Recovery Action** tab in **Property**.
3. On the **Recovery Action** tab, you can display or change the monitoring settings by following the description below.

Specify the recovery target and the action upon detecting an error. For message receive monitor resources, select "Restart the recovery target", "Executing failover to the recovery target", or "Execute the final action" as the action to take when an error is detected. However, if the recovery target is inactive, the recovery action is not performed.

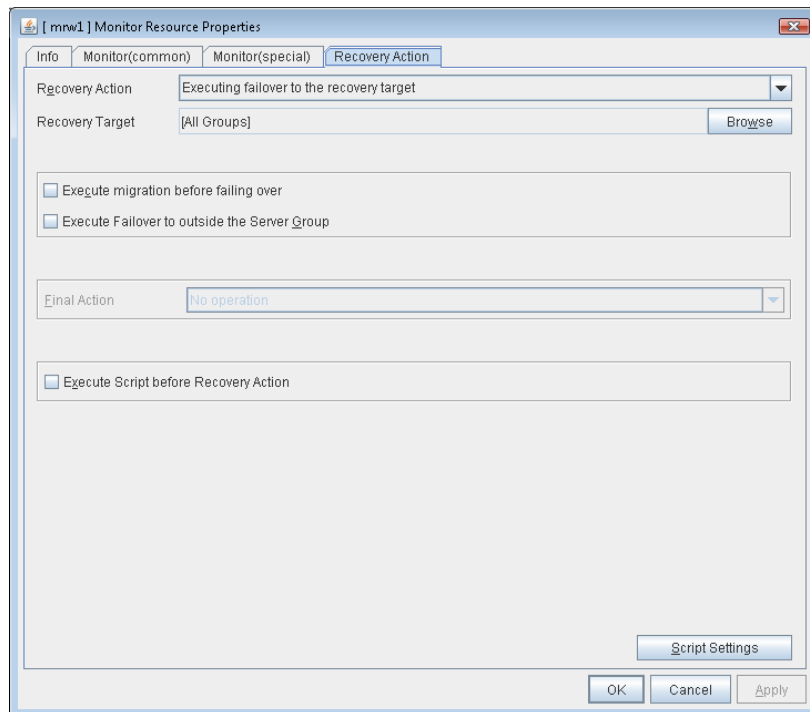

### Recovery Action

Select the action to take when a monitor error is detected.

- ◆ Executing the recovery script  
Execute the recovery script when a monitor error is detected.
- ◆ Restart the recovery target  
Restart the group or group resource selected as the recovery target when a monitor error is detected.
- ◆ Executing failover to the recovery target  
Perform failover for the group selected as the recovery target or the group to which the group resource selected as the recovery target belongs when a monitor error is detected.
- ◆ Execute the final action  
Execute the selected final action when a monitor error is detected.

**Execute Failover to outside the Server Group**

Can be configured only for message receive monitor resources. Specify whether to fail over to a server group other than the active server group upon the reception of an error message.

**Execute Script before Recovery Action**

Executes the script before the operation performed upon error detection selected as the recovery action.

- ◆ When the check box is selected  
A script/command is executed before reactivation. To configure the script/command setting, click Settings.
- ◆ When the check box is not selected  
Any script/command is not executed.

\* For details on settings other than those above, see “Displaying and changing the settings of the time when an error is detected by a monitor resource (Common to monitor resources)” on page 692.



## Displaying the properties of a message receive monitor resource by using the WebManager

1. Start the WebManager (<http://FIP address for Web Manager group:port number> (default value: 29003)).
2. In the tree view, click the object icon  for a message receive monitor resource. The following information is displayed in the list view:

Message receive Monitor Name: mrw1		Details	
Common		server1	server2
Properties	Value		
Comment			
Category	NIC		
Keyword			
Status	Normal		
Resource Status on Each Server			
Server Name	Status		
server1	Normal		
server2	Normal		

Comment:	Comment on the message receive monitor resource
Keyword:	Target of message receive monitor resource monitoring
Category:	Type of message receive monitor resource monitoring
Status	Status of the message receive monitor resource
Server Name:	Name of the server
Status:	Status of the monitor resource on each server

When you click **Details**, the following information is displayed in the pop-up dialog box:

Properties	Value
Name	mrw1
Type	mrw
Monitor Timing	Always
Target Resource	
Interval (sec)	10
Timeout (sec)	30
Do Not Retry at Timeout Occurrence	Off
Do Not Execute Recovery Action at Timeout Occurrence	Off
Retry Count	0
Final Action	No operation
Execute Script Before Reactivation	Off
Execute Script Before Failover	Off
Execute Script before Final Action	Off
Recovery Target	[All Groups]
Recovery Target Type	Group
Recovery Script Threshold	0
Reactivation Threshold	0
Failover Threshold	1
Wait Time to Start Monitoring (sec)	0
Nice Value	19
Monitor Suspend Possibility	Possible
Dummy Failure Possibility	Impossible
Collect Dump at Timeout Occurrence	Off
Run Migration Before Run Failover	Off
Execute Failover to outside the Server Group	Off

**Name:** Message receive monitor resource name  
**Type:** Monitor resource type  
**Monitor Timing:** Monitor resource monitoring start time  
**Target Resource:** Monitor target resource  
**Interval(sec):** Interval between monitor target status checks (in seconds)  
**Timeout(sec):** Timeout for monitoring (in seconds)  
**Do Not Retry at Timeout Occurrence:** Whether or not to retry when timeout occurs  
**Do Not Execute Recovery Action at Timeout Occurrence:** Whether or not to execute recovery action when timeout occurs  
**Retry Count:** Retry count used to determine that the monitor resource has an error after detecting a monitor target error  
**Final Action:** Final action when an error is detected  
**Execute Script before Reactivation:** Whether the pre-reactivation script is executed upon the detection of an error  
**Execute Script before Failover:** Whether the pre-failover script is executed upon the detection of an error  
**Execute Script before Final Action:** Whether the pre-final-action script is executed upon the detection of an error  
**Recovery Target:** Recovery target when an error is detected  
**Recovery Target Type:** Recovery target type when an error is detected  
**Recovery Script Threshold:** The number of times the recovery script is executed upon the detection of an error  
**Reactivation Threshold:** Reactivation count when an error is detected  
**Failover Threshold:** Failover count when an error is detected  
**Wait Time to Start Monitoring(sec):** Wait time until monitoring starts (in seconds)  
**Nice Value:** Nice value of the monitor resource  
**Monitor Suspend Possibility:** Possibility of pausing monitor resource monitoring  
**Dummy Failure Possibility:** Possibility of Dummy Failure  
**Collect Dump at Timeout Occurrence:** Whether or not dump of monitor process is collected when timeout occurs

Run Migration Before Run Failover: Whether or not migration is run before running failover  
Execute Failover to outside the Server Group: Failover to a server in a server group other than the active server group

## Understanding VM monitor resources

VM monitor resources check whether the virtual machine is alive.

### Notes on VM monitor resources

- ◆ This resource is automatically registered when a virtual machine resource is added.
- ◆ For the supported virtual infrastructure versions, see “Software Operation Environment of VM resources” in Chapter 3, “Installation requirements for EXPRESSCLUSTER” in the *Getting Started Guide*.
- ◆ The times counter of the recovery action kept by the monitor resource is not reset even though the virtual machine monitor resource recovery is detected while recovery action is in transit, or after all the recovery action have completed. Execute either one of the following procedures when you want to reset the times counter of the recovery action.
  - Reset the times counter of the recovery action by the `clpmonctrl` command.
  - Execute cluster stop/start with the `clpcl` command or WebManager.

### Monitoring by VM monitor resources

VM monitor resources monitor the following:

#### **If the virtual machine type is vSphere**

VM monitor resources monitor the virtual machine by using the VMware vSphere API.

An error is detected if the monitoring result is one of the following:

- (1) The VM status is POWEROFF, SHUTDOWN, or SUSPENDED.
- (2) Acquiring the VM status failed.

#### **If the virtual machine type is Xenserver**

VM monitor resources monitor the virtual machine by using a general-purpose virtualization library.

An error is detected if the monitoring result is one of the following:

- (1) The VM status is HALTED, PAUSED, or SUSPENDED.
- (2) Acquiring the VM status failed.

#### **If the virtual machine type is Kvm**

VM monitor resources monitor the virtual machine by using a general-purpose virtualization library.

An error is detected if the monitoring result is one of the following:

- (1) The VM status is BLOCKED, SHUTDOWN, PAUSED, SHUTOFF, CRASHED, or NOSTATE.
- (2) Acquiring the VM status failed.

## Displaying and changing the details of the VM monitor resources

1. Click the **Monitor Resource** icon in the tree view on the left side of the Builder window.
2. The list of monitor resources is shown in the table view on the right side of the screen. Right-click the target VM monitor resource name, and then click the **Monitor(special)** tab in **Property**.
3. On the **Monitor(special)** tab, you can display or change detailed settings by following the description below.

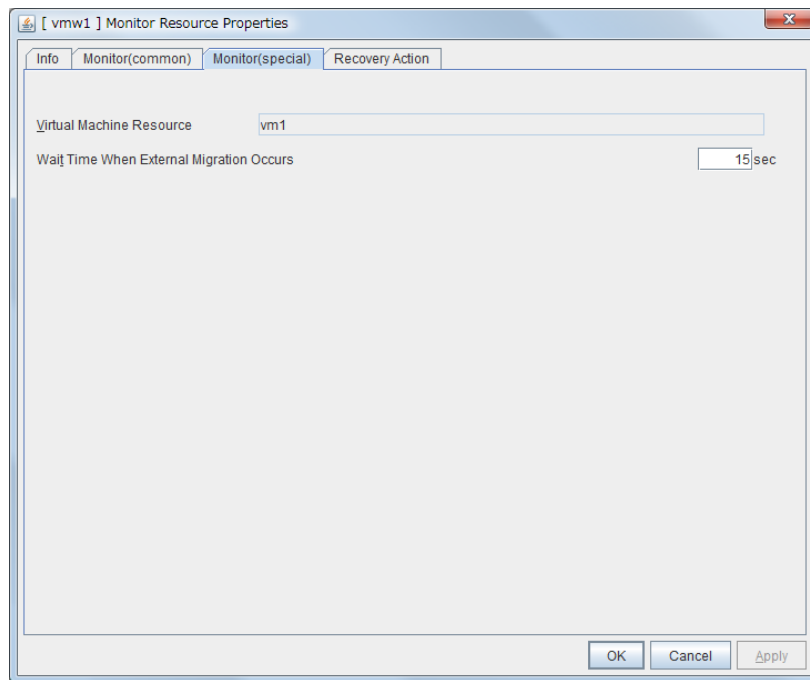

### Wait Time for External Migration

Specify the time to wait for the completion of the migration.

## Displaying the properties of a VM monitor resource by using the WebManager

1. Start the WebManager.
2. In the tree view, click the object icon  for a VM monitor resource. The following information is displayed in the list view:

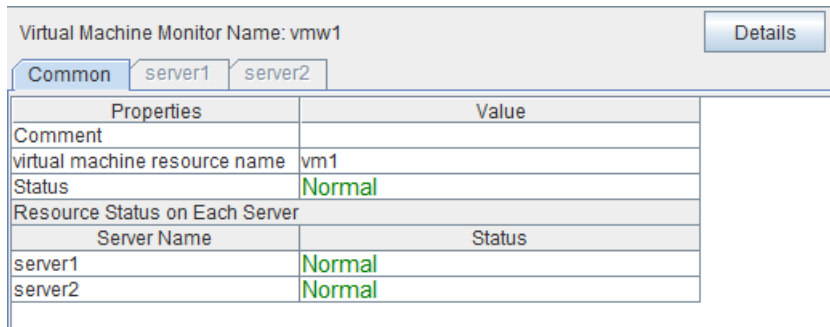

Virtual Machine Monitor Name: vmw1	
Properties	Value
Comment	
virtual machine resource name	vm1
Status	Normal
Resource Status on Each Server	
Server Name	Status
server1	Normal
server2	Normal

Comment:	Comment on the VM monitor resource
VM Resource Name:	Virtual machine resource name
Status	Status of the VM monitor resource
Server Name:	Name of the server
Status:	Status of the monitor resources on each server

When you click **Details**, the following information is displayed in the pop-up dialog box:

Properties	Value
Name	vmw1
Type	vmw
Monitor Timing	Always
Target Resource	
Interval (sec)	10
Timeout (sec)	30
Do Not Retry at Timeout Occurrence	Off
Do Not Execute Recovery Action at Timeout Occurrence	Off
Retry Count	0
Final Action	No operation
Execute Script Before Reactivation	Off
Execute Script Before Failover	Off
Execute Script before Final Action	Off
Recovery Target	vm1
Recovery Target Type	Resource
Recovery Script Threshold	0
Reactivation Threshold	3
Failover Threshold	1
Wait Time to Start Monitoring (sec)	0
Nice Value	0
Monitor Suspend Possibility	Possible
Dummy Failure Possibility	Impossible
Collect Dump at Timeout Occurrence	Off
Run Migration Before Run Failover	Off

Name:	VM monitor resource name
Type:	Monitor resource type
Monitor Timing:	Monitor resource monitoring start time
Target Resource:	Monitor target resource
Interval(sec):	Interval between monitor target status checks (in seconds)
Timeout(sec):	Timeout for monitoring (in seconds)
Do Not Retry at Timeout Occurrence:	Whether or not to retry when timeout occurs
Do Not Execute Recovery Action at Timeout Occurrence:	Whether or not to execute recovery action when timeout occurs
Retry Count:	Retry count used to determine that the monitor resource has an error after detecting a monitor target error
Final Action:	Final action when an error is detected
Execute Script before Reactivation:	Whether the pre-reactivation script is executed upon the detection of an error
Execute Script before Failover:	Whether the pre-failover script is executed upon the detection of an error
Execute Script before Final Action:	Whether the pre-final-action script is executed upon the detection of an error
Recovery Target:	Recovery target when an error is detected
Recovery Target Type:	Recovery target type when an error is detected
Recovery Script Threshold:	The number of times the recovery script is executed upon the detection of an error
Reactivation Threshold:	Reactivation count when an error is detected
Failover Threshold:	Failover count when an error is detected
Wait Time to Start Monitoring(sec):	Wait time until monitoring starts (in seconds)
Nice Value:	Nice value of the monitor resource
Monitor Suspend Possibility:	Possibility of pausing monitor resource monitoring
Dummy Failure Possibility:	Possibility of Dummy Failure
Collect Dump at Timeout Occurrence:	Whether or not dump of monitor process is collected when timeout occurs
Run Migration Before Run Failover:	Whether or not migration is run before running failover

## Understanding Dynamic DNS monitor resources

### Notes on Dynamic DNS monitor resources

There are no detailed settings for Dynamic DNS monitor resources. These monitor resources are used when using the Dynamic DNS resources in EXPRESSCLUSTER.

- ◆ A Dynamic DNS monitor resource is automatically created when a Dynamic DNS resource is added. One Dynamic DNS monitor resource is automatically created for each Dynamic DNS resource.
- ◆ Dynamic DNS monitor resources cannot be deleted. They are automatically deleted when the Dynamic DNS resource is deleted.
- ◆ Do not change the recovery target.
- ◆ Monitoring cannot be paused or resumed using the `clpmonctrl` command or from the WebManager.
- ◆ Dynamic DNS monitor resources periodically register virtual host names with the DDNS server. If the target Dynamic DNS resource is active while the cluster is suspended, the Dynamic DNS monitor resource continues operating.
- ◆ The setting of Monitor(common) tab-Retry Count is invalid. When you'd like to delay error detection, please change the setting of Monitor(common) tab-Timeout.

### Settings for Dynamic DNS monitor resources

Dynamic DNS monitor resources periodically register virtual host names with the DDNS server. There are no detailed settings for Dynamic DNS monitor resources.



## Displaying the properties of a Dynamic DNS monitor resource by using the WebManager

1. Start the WebManager.
2. In the tree view, click the object icon  for a Dynamic DNS monitor resource. The following information is displayed in the list view:

Dynamic DNS Monitor Name: ddnsw1		Details	
Common		server1	server2
Properties	Value		
Comment			
Monitor Target	ddns1		
Status	Normal		
Resource Status on Each Server			
Server Name	Status		
server1	Normal		
server2	Offline		

Comment:

Comment on the Dynamic DNS monitor resource

Monitor Target:

Monitor target Dynamic DNS resource name

Status

Status of the Dynamic DNS monitor resource

Server Name:

Name of the server

Status

Status of the monitor resource on each server

When you click **Details**, the following information is displayed in the pop-up dialog box:

Properties	Value
Name	ddnsw1
Type	ddnsw
Monitor Timing	Activating
Target Resource	ddns1
Interval (sec)	60
Timeout (sec)	100
Do Not Retry at Timeout Occurrence	Off
Do Not Execute Recovery Action at Timeout Occurrence	Off
Retry Count	0
Final Action	No operation
Execute Script Before Reactivation	Off
Execute Script Before Failover	Off
Execute Script before Final Action	Off
Recovery Target	ddns1
Recovery Target Type	Resource
Recovery Script Threshold	0
Reactivation Threshold	3
Failover Threshold	1
Wait Time to Start Monitoring (sec)	0
Nice Value	0
Monitor Suspend Possibility	Impossible
Dummy Failure Possibility	Impossible
Collect Dump at Timeout Occurrence	Off
Run Migration Before Run Failover	Off

- Name: Dynamic DNS monitor resource name
- Type: Monitor resource type
- Monitor Timing: Monitor resource monitoring start time
- Target Resource: Name of the monitor target Dynamic DNS resource
- Interval (sec): Interval between monitor target status checks (in seconds)
- Timeout (sec): Timeout for monitoring (in seconds)
- Do Not Retry at Timeout Occurrence: Whether or not to retry when timeout occurs
- Do Not Execute Recovery Action at Timeout Occurrence: Whether or not to execute recovery action when timeout occurs
- Retry Count: Retry count used to determine that the monitor resource has an error after detecting a monitor target error
- Final Action: Final action when an error is detected
- Execute Script before Reactivation: Whether the pre-reactivation script is executed upon the detection of an error
- Execute Script before Failover: Whether the pre-failover script is executed upon the detection of an error
- Execute Script before Final Action: Whether the pre-final-action script is executed upon the detection of an error
- Recovery Target: Recovery target when an error is detected
- Recovery Target Type: Recovery target type when an error is detected
- Recovery Script Threshold: The number of times the recovery script is executed upon the detection of an error
- Reactivation Threshold: Reactivation count when an error is detected
- Failover Threshold: Failover count when an error is detected
- Wait Time to Start Monitoring (sec): Wait time until monitoring starts (in seconds)
- Nice Value: Nice value of the monitor resource
- Monitor Suspend Possibility: Possibility of pausing monitoring
- Dummy Failure Possibility: Possibility of Dummy Failure
- Collect Dump at Timeout Occurrence: Whether or not dump of monitor process is collected when timeout occurs
- Run Migration Before Run Failover: Whether or not migration is run before running failover

## Understanding process name monitor resources

Process name monitor resources monitor the process of specified processes. Process stalls cannot be detected.

### Notes on process name monitor resources

If there are two or more processes having the name specified for the monitor target, only one process is selected according to the following conditions and is subject to monitoring.

If you set 1 for **Minimum Process Count**, and if there are two or more processes having the process name specified for the monitor target, only one process is selected under the following conditions and is subject to monitoring.

1. When the processes are in a parent-child relationship, the parent process is monitored.
2. When the processes are not in a parent-child relationship, the process having the earliest activation time is monitored.
3. When the processes are not in a parent-child relationship and their activation times are the same, the process having the lowest process ID is monitored.

If monitoring of the number of started processes is performed when there are multiple processes with the same name, specify the process count to be monitored for **Minimum Process Count**. If the number of processes with the same name falls short of the specified minimum count, an error is recognized. You can set 1 to 999 for **Minimum Process Count**. If you set 1, only one process is selected for monitoring.

Up to 1023 bytes can be specified for the monitor target process name. To specify a monitor target process with a name that exceeds 1023 bytes, use a wildcard (such as \*).

If the name of the target process is 1024 bytes or longer, only the first 1023 bytes can be recognized as the process name. If you use a wild card (such as \*) to specify a process name, specify a string containing the first 1024 or fewer bytes.

If the name of the target process is long, the latter part of the process name is omitted and output to the log.

If the name of the target process includes double quotations( "" ) or a comma ( , ), the process name might not be correctly output to an alert message.

Check the monitor target process name which is actually running by `ps(1)` command, etc, and specify the monitor target process name.

Execution result

UID	PID	PPID	C	STIME	TTY	TIME	CMD
root	1	0	0	Sep12	?	00:00:00	init [5]
:							
root	5314	1	0	Sep12	?	00:00:00	/usr/sbin/acpid
root	5325	1	0	Sep12	?	00:00:00	/usr/sbin/sshd
htt	5481	1	0	Sep12	?	00:00:00	/usr/sbin/htt -retryonerror 0
:							

From the above command result, `/usr/sbin/htt -retryonerror 0` is specified as monitor target process name in the case of monitoring `/usr/sbin/htt`.

The process name specified for the name of the target process specifies the target process, using the process arguments as part of the process name. To specify the name of the target process, specify the process name containing the arguments. To monitor only the process name with the arguments excluded, specify it with the wildcard (\*) using right truncation or partial match excluding the arguments.

## How process name monitor resources perform monitoring

The process name monitor resource monitors a process having the specified process name. If **Minimum Process Count** is set to 1, the process ID is identified from the process name and the deletion of the process ID is treated as an error. Process stalls cannot be detected.

If **Minimum Process Count** is set to a value greater than 1, the number of processes that have the specified process name are monitored. The number of processes to be monitored is calculated using the process name, and if the number falls below the minimum count, an error is recognized. Process stalls cannot be detected.

## Displaying and changing the details of the process name monitor resources

1. Click the **Monitors** icon on the tree view displayed on the left side of the Builder window.
2. The list of monitor resources is shown in the table view on the right side of the screen. Right-click the target monitor resource name, and then click the **Monitor(special)** tab in **Properties**.
3. On the **Monitor(special)** tab, display or change the advanced settings by following the instructions below.

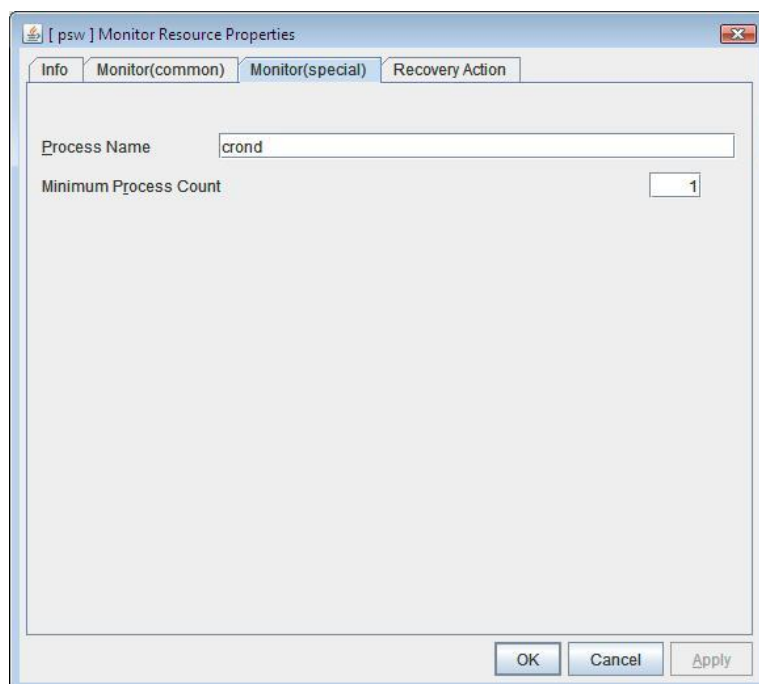

### Process name

Set the name of the target process. The process name can be obtained by using the ps(1) command

Wild cards can be used to specify a process name by using one of the following three patterns. No other wild card pattern is permitted.

- [prefix search] <string included in the process name>\*
- [suffix search] \*<string included in the process name>
- [partial search] \*<string included in the process name>\*

**Minimum Process Count (1 to 999)**

Set the process count to be monitored for the monitor target process. If the number of processes having the specified monitor target process name falls short of the set value, an error is recognized.

Displaying the process name monitor resource properties with WebManager

1. Start the WebManager.
2. When you click an object corresponding to a process name monitor resource  in the tree view, the following information is displayed in the list view.

Process Name Monitor Name: psw		Details
<div style="display: flex; border-bottom: 1px solid black;"> <span style="border: 1px solid black; padding: 2px 5px;">Common</span> <span style="border: 1px solid black; padding: 2px 5px; margin-left: 5px;">server-01</span> <span style="border: 1px solid black; padding: 2px 5px; margin-left: 5px;">server-02</span> </div>		
Properties	Value	
Comment		
Process Name	crond	
Minimum Monitored Process Count	1	
Status	Normal	
Resource Status on Each Server		
Server Name	Status	
server-01	Normal	
server-02	Normal	

Comment: Comment on the process name monitor resource  
 Monitor Target Process Name: Name of the process to be monitored  
 Minimum Monitored Process Count: Minimum number of processes to be monitored  
 Status: Status of the process name monitor resource  
 Server Name: Server name  
 Status: Status of the monitor resource on the server

When you click **Details**, the following information is displayed in the pop-up dialog box:

Properties	Value
Name	genw1
Type	genw
Monitor Timing	Always
Target Resource	
Interval (sec)	60
Timeout (sec)	120
Do Not Retry at Timeout Occurrence	Off
Do Not Execute Recovery Action at Timeout Occurrence	Off
Retry Count	0
Final Action	No operation
Execute Script Before Reactivation	Off
Execute Script Before Failover	Off
Execute Script before Final Action	Off
Recovery Target	LocalServer
Recovery Target Type	Itself
Recovery Script Threshold	0
Reactivation Threshold	0
Failover Threshold	0
Wait Time to Start Monitoring (sec)	0
Nice Value	0
Monitor Suspend Possibility	Possible
Dummy Failure Possibility	Possible
Collect Dump at Timeout Occurrence	Off
Run Migration Before Run Failover	Off
Monitor Type	Synchronous
Log Output Path	
Script Log Rotate	Off
Script Log Rotate Size (byte)	1000000
Script Log Rotate Generation	2

Name:	Name of the process name monitor resource
Type:	Monitor resource type
Monitor Timing:	Monitor resource monitoring start time
Target Resource:	Name of the process to be monitored
Interval (sec):	Interval between monitor target status checks (in seconds)
Timeout (sec):	Timeout for monitoring (in seconds)
Do Not Retry at Timeout Occurrence:	Whether or not to retry when timeout occurs
Do Not Execute Recovery Action at Timeout Occurrence:	Whether or not to execute recovery action when timeout occurs
Retry Count:	Retry count used to determine that the monitor resource has an error after detecting a monitor target error
Final Action:	Final action when an error is detected
Execute Script before Reactivation:	Whether the pre-reactivation script is executed upon the detection of an error
Execute Script before Failover:	Whether the pre-failover script is executed upon the detection of an error
Execute Script before Final Action:	Whether the pre-final-action script is executed upon the detection of an error
Recovery Target:	Recovery target when an error is detected
Recovery Target Type:	Recovery target type when an error is detected
Recovery Script Threshold:	The number of times the recovery script is executed upon the detection of an error
Reactivation Threshold:	Reactivation count when an error is detected
Failover Threshold:	Failover count when an error is detected
Wait Time to Start Monitoring (sec):	Wait time until monitoring starts (in seconds)

Nice Value:	Nice value of the monitor resource
Monitor Suspend Possibility:	Possibility of pausing monitor resource monitoring
Dummy Failure Possibility	Possibility of Dummy Failure
Collect Dump at Timeout Occurrence:	Whether or not dump of monitor process is collected when timeout occurs
Run Migration Before Run Failover:	Whether or not migration is run before running failover



## Understanding BMC monitor resources

This cannot be used.

## Understanding DB2 monitor resources

DB2 monitor resource monitors DB2 database that operates on servers.

### Note on DB2 monitor resources

For the supported versions of DB2, see "Software Applications supported by monitoring options" of "Software" in Chapter 3, "Installation requirements for EXPRESSCLUSTER" in the *Getting Started Guide*.

This monitoring resource monitors DB2, using the CLI library of DB2. For this reason, it is required to execute "source *instance user home/sqllib/db2profile*" as root user. Write this in a start script.

To monitor a DB2 database that runs in the guest OS on a virtual machine controlled by a VM resource, specify the VM resource as the monitor target and specify enough wait time for the DB2 database to become accessible after the VM resource is activated for **Wait Time to Start Monitoring**. Also, set up the DB2 client on the host OS side, where monitor resources run, and register the database on the virtual machine to the database node directory.

If the code page of the database and the one of this monitor resource differ, this monitor resource cannot access to the DB2 database. Set an appropriate character code as necessary.

To check the code page of database, execute "db2 get db cfg for *Database\_name*." For details, see DB2 manual.

If values of database name, instance name, user name and password specified by a parameter differ from the DB2 environment for monitoring, DB2 cannot be monitored. Error message is displayed. Check the environment.

If "Level 1" or "Level 2" is selected as a monitor level described in the next subsection "How DB2 monitor resources perform monitoring", monitor tables must be created manually beforehand.

A monitor error occurs if there is no monitor table at the start of monitoring in "Level 1".

If there is no monitor table at the start of monitoring in "Level 2", EXPRESSCLUSTER automatically creates the monitor table. In this case, a message indicating that the WebManager alert view does not have the monitor table is displayed.

The load on the monitor at "Level 3" is higher than that at "Level 1" and "Level 2" because the monitor in "Level 3" creates or deletes monitor tables for each monitoring.

Selectable monitor level	Prior creation of a monitor table
Level 1 (monitoring by select)	Required
Level 2 (monitoring by update/select)	Required
Level 3 (create/drop table each time)	Optional

Create a monitor table using either of the following methods:

Alphanumeric characters and some symbols (such as underscores) can be used to specify a monitor table name.

**Use SQL statements (in the following example, the monitor table is named db2watch)**

```
sql> create table <user_name>.db2watch (num int not null primary key)
sql> insert into db2watch values(0)
sql> commit
```

**Use EXPRESSCLUSTER command**

```
clp_db2w --createtable -n <DB2_monitor_resource_name>
```

To manually delete a monitor table, execute the following command:

```
clp_db2w --deletetable -n <DB2_monitor_resource_name>
```

## How DB2 monitor resources perform monitoring

DB2 monitor resources perform monitoring according to the specified monitor level.

◆ Level 1 (monitoring by select)

Monitoring with only reference to the monitor table. SQL statements executed for the monitor table are of (select) type.

An error is recognized if:

(1) An error message is sent in response to a database connection or SQL statement message

◆ Level 2 (monitoring by update/select)

Monitoring with reference to and update of the monitoring table. One SQL statement can read/write numerical data of up to 11 digits. SQL statements executed for the monitor table are of (update/select) type.

If a monitor table is automatically created at the start of monitoring, the SQL statement (create/insert) is executed for the monitor table.

An error is recognized if:

(1) An error message is sent in response to a database connection or SQL statement message

(2) The written data is not the same as the read data

◆ Level 3 (create/drop table each time)

Creation/deletion of the monitor table by statement as well as update. One SQL statement can read/write numerical data of up to 11 digits. SQL statements executed for the monitor table are of (create / insert / select / drop) type.

An error is recognized if:

(1) An error message is sent in response to a database connection or SQL statement message

(2) The written data is not the same as the read data

## Displaying and changing the DB2 monitor resource details

1. Click the **Monitors** icon on the tree view displayed on the left side of the Builder window.
2. List of the monitor resources is displayed in the table view on the right side of the screen. Right-click the target DB2 monitor resource, and click the **Monitor(special)** tab in the **Monitor Resource Property** window.
3. On the **Monitor(special)** tab, you can see and/or change the detailed settings by following the description below.

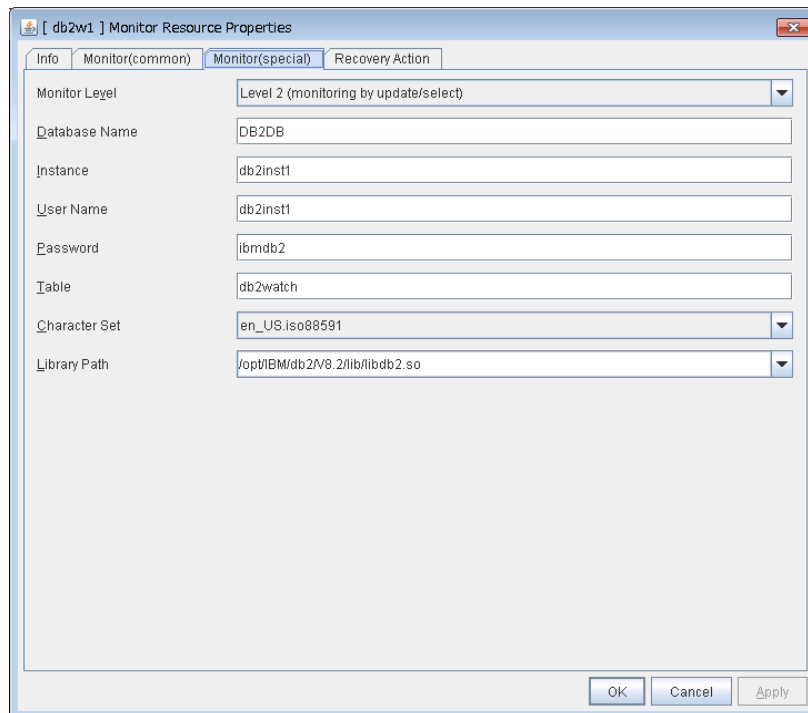

### Monitor Level

Select one of the following levels. You cannot omit this level setting.

- ◆ Level 1 (monitoring by select)
 

Monitoring with only reference to the monitor table. SQL statements executed for the monitor table are of (select) type.
- ◆ Level 2 (monitoring by update/select)
 

Monitoring with reference to and update of the monitoring table. SQL statements executed for the monitor table are of (update/select) type.

If a monitor table is automatically created at the start of monitoring, the SQL statement (create/insert) is executed for the monitor table.
- ◆ Level 3 (create/drop table each time)
 

Creation/deletion of the monitor table by statement as well as update. SQL statements executed for the monitor table are of (create / insert / select / drop) type.

Default: Level 2 (monitoring by update/select)

**Database Name** Within 255 bytes

Specify the database to be monitored. You must specify the database.

Default value: None

**Instance** Within 255 bytes

Specify the instance name of the database to be monitored. You must specify the instance name.

Default value: db2inst1

**User Name** Within 255 bytes

Specify the user name to log on to the database. You must specify the user name.

Specify the DB2 user who can access the specified database.

Default value: db2inst1

**Password** Within 255 bytes

Specify the password to log on to the database. You must specify the password.

Default value: ibmdb2

**Table** Within 255 bytes

Specify the name of a monitor table created on the database. You must specify the name.

Make sure not to specify the same name as the table used for operation because a monitor table will be created and deleted. Be sure to set the name different from the reserved word in SQL statements. Some characters cannot be used to specify a monitor table name according to the database specifications. For details, refer to the database specifications.

Default value: db2watch

**Character Set**

Specify the character set of DB2. You must specify the character code.

Default value: None

**Library Path** Within 1023 bytes

Specify the home path to DB2. You must specify the path.

Default value: /opt/IBM/db2/V8.2/lib/libdb2.so

## Displaying the DB2 monitor resource properties with the WebManager

1. Start the WebManager.
2. When you click an object for a DB2 monitor resource  in the tree view, the following information is displayed in the list view.

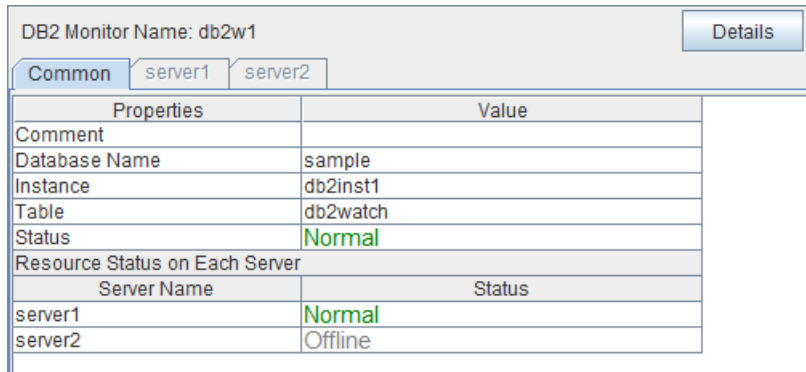

DB2 Monitor Name: db2w1		Details
Common		server1
server2		
Properties	Value	
Comment		
Database Name	sample	
Instance	db2inst1	
Table	db2watch	
Status	Normal	
Resource Status on Each Server		
Server Name	Status	
server1	Normal	
server2	Offline	

Comment:	Comment on the DB2 monitor resource
Database Name:	Monitor target database name
Instance:	Name of the instance be monitored
Table:	Monitor table name created on a database
Status:	DB2 monitor resource status
Server Name:	Server name
Status:	Status of the monitor resource on the server

When you click **Details**, the following information is displayed in the pop-up dialog box:

Properties	Value
Name	db2w1
Type	db2w
Monitor Timing	Activating
Target Resource	exec1
Interval (sec)	60
Timeout (sec)	120
Do Not Retry at Timeout Occurrence	Off
Do Not Execute Recovery Action at Timeout Occurrence	Off
Retry Count	2
Final Action	Stop the cluster service and shutdown OS
Execute Script Before Reactivation	Off
Execute Script Before Failover	Off
Execute Script before Final Action	Off
Recovery Target	failover1
Recovery Target Type	Group
Recovery Script Threshold	0
Reactivation Threshold	0
Failover Threshold	1
Wait Time to Start Monitoring (sec)	0
Nice Value	0
Monitor Suspend Possibility	Possible
Dummy Failure Possibility	Possible
Collect Dump at Timeout Occurrence	Off
Run Migration Before Run Failover	Off
Character Set	en_US.iso88591
Library Path	/opt/IBM/db2/V8.2/lib/libdb2.so
Monitor Action	Level 2 (monitoring by update/select)

- Name: DB2 monitor resource name
- Type: Monitor resource type
- Monitor Timing: Timing to start monitoring
- Target Resource: Resource to be monitored
- Interval (sec): Interval between monitoring (in seconds)
- Timeout (sec): Timeout for monitoring (in seconds)
- Do Not Retry at Timeout Occurrence: Whether or not to retry when timeout occurs
- Do Not Execute Recovery Action at Timeout Occurrence: Whether or not to execute recovery action when timeout occurs
- Retry Count: The number of retries to be made from detection of an error in the monitor target to establish the error as an error
- Final Action: Final action at detection of an error
- Execute Script before Reactivation: Whether the pre-reactivation script is executed upon the detection of an error
- Execute Script before Failover: Whether the pre-failover script is executed upon the detection of an error
- Execute Script before Final Action: Whether the pre-final-action script is executed upon the detection of an error
- Recovery Target: Target to be recovered when an error is detected
- Recovery Target Type: Type of target to be recovered when an error is detected
- Recovery Script Threshold: The number of times the recovery script is executed upon the detection of an error
- Reactivation Threshold: The number of reactivations to be made at detection of an error
- Failover Threshold: The number of failovers to be made at detection of an error
- Wait Time to Start Monitoring (sec): Time to wait before starting monitoring (in seconds)
- Nice Value: Monitor resource nice value
- Monitor Suspend Possibility: Possibility of suspending monitoring
- Dummy Failure Possibility: Possibility of Dummy Failure

Collect Dump at Timeout Occurrence:	Whether or not dump of monitor process is collected when timeout occurs
Run Migration Before Run Failover:	Whether or not migration is run before running failover
Character Set:	Character set of DB2
Library Path:	Library path of DB2
Monitor Action:	Monitor level



## Understanding FTP monitor resources

FTP monitor resources monitor FTP services that run on the server. FTP monitor resources monitor FTP protocol and they are not intended for monitoring specific applications. FTP monitor resources monitor various applications that use FTP protocol.

### FTP monitor resources

For monitoring target resources, specify EXEC resources etc. that start FTP. Monitoring starts after a target resource is activated. However, if FTP cannot be started immediately after target resource is activated, adjust the time using **Wait Time to Start Monitoring**.

To monitor an FTP server that runs in the guest OS on a virtual machine controlled by a VM resource, specify the VM resource as the monitor target and specify enough wait time for the FTP server to become accessible after the VM resource is activated for **Wait Time to Start Monitoring**.

FTP service may produce operation logs for each monitoring. Configure FTP settings if this needs to be adjusted.

If a change is made to a default FTP message (such as a banner or welcome message) on the FTP server, it may be handled as an error.

### Monitoring by FTP monitor resources

FTP monitor resources connect to the FTP server and execute the command for acquiring the file list. As a result of monitoring, the following is considered as an error:

- (1) When connection to the FTP service fails.
- (2) When an error is notified as a response to the FTP command.

## Displaying and changing the FTP monitor resource details

1. Click **Monitors** on the tree view displayed on the left side of the Builder window.
2. List of the monitor resources is displayed in the table view on the right side of the screen. Right-click the target FTP monitor resource, and click the **Monitor(special)** tab in the Monitor Resource Property window.
3. On the **Monitor(special)** tab, you can display and/or change the detailed settings by following the description below.

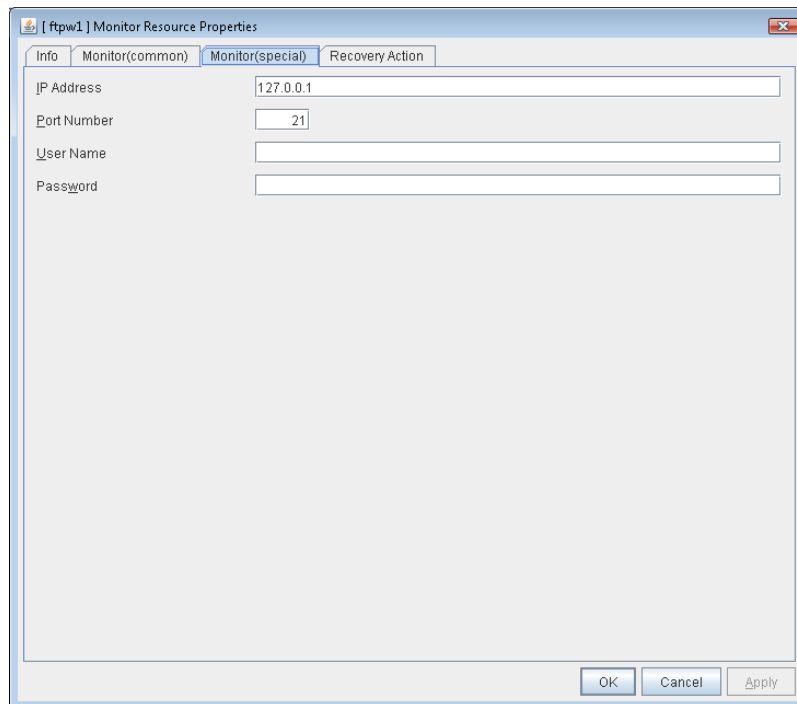

### **IP Address** (Within 79 bytes )

Specify the IP address of the FTP server to be monitored. You must specify this IP address. If it is multi-directional standby server, specify FIP.

Usually, specify the loopback address (127.0.0.1) to connect to the FTP server that runs on the local server. If the addresses for which connection is possible are limited by FTP server settings, specify an address for which connection is possible (such as a floating IP address). To monitor an FTP server that runs in the guest OS on a virtual machine controlled by a VM resource, specify the IP address of the virtual machine.

Default value: 127.0.0.1

### **Port No.** (1-65535)

Specify the FTP port number to be monitored. You must specify a port number.

Default value: 21

**User Name** (Within 255 bytes)

Specify the user name to log on to FTP.

Default value: None

**Password** (Within 255 bytes)

Specify the password to log on to FTP.

Default value: None

## Displaying the FTP monitor resource properties with the WebManager

1. Start the WebManager.
2. Click a FTP monitor resources object , in the tree view. The following information is displayed in the list view.

FTP Monitor Name: ftpw1		Details
<span>Common</span> <span>server1</span> <span>server2</span>		
Properties	Value	
Comment		
IP Address	127.0.0.1	
Port	21	
Status	Normal	
Resource Status on Each Server		
Server Name	Status	
server1	Normal	
server2	Offline	

Comment:	Comment of the FTP monitor resource
IP Address:	IP address of the FTP server to be monitored
Port No.:	Port number of the FTP to be monitored
Status:	Status of the FTP monitor resource
Server Name:	Server name
Status:	Status of the monitor resource on the given server

When you click **Details**, the following information is displayed in the pop-up dialog box:

Properties	Value
Name	ftpw1
Type	ftpw
Monitor Timing	Activating
Target Resource	exec1
Interval (sec)	60
Timeout (sec)	120
Do Not Retry at Timeout Occurrence	Off
Do Not Execute Recovery Action at Timeout Occurrence	Off
Retry Count	3
Final Action	Stop the cluster service and shutdown OS
Execute Script Before Reactivation	Off
Execute Script Before Failover	Off
Execute Script before Final Action	Off
Recovery Target	LocalServer
Recovery Target Type	Itself
Recovery Script Threshold	0
Reactivation Threshold	0
Failover Threshold	0
Wait Time to Start Monitoring (sec)	0
Nice Value	0
Monitor Suspend Possibility	Possible
Dummy Failure Possibility	Possible
Collect Dump at Timeout Occurrence	Off
Run Migration Before Run Failover	Off

- Name: FTP monitor resource name
- Type: Monitor resource type
- Monitor Timing: Timing to start monitoring
- Target Resource: Resource to be monitored
- Interval(sec): Interval between monitoring (in seconds)
- Timeout(sec): Timeout for monitoring (in seconds)
- Do Not Retry at Timeout Occurrence: Whether or not to retry when timeout occurs
- Do Not Execute Recovery Action at Timeout Occurrence: Whether or not to execute recovery action when timeout occurs
- Retry Count: The number of retries to be made from detection of an error in the monitor target to establish the error as error
- Final Action: Final action at detection of an error
- Execute Script before Reactivation: Whether the pre-reactivation script is executed upon the detection of an error
- Execute Script before Failover: Whether the pre-failover script is executed upon the detection of an error
- Execute Script before Final Action: Whether the pre-final-action script is executed upon the detection of an error
- Recovery Target: Target to be recovered when an error is detected
- Recovery Target Type: Type of target to be recovered when an error is detected
- Recovery Script Threshold: The number of times the recovery script is executed upon the detection of an error
- Reactivation Threshold: The number of reactivations to be made at detection of an error
- Failover Threshold: The number of failovers to be made at detection of an error
- Wait Time to Start Monitoring(sec): Time to wait before starting of monitoring (in seconds)
- Nice Value: Nice value
- Monitor Suspend Possibility: Possibility of suspending monitoring
- Dummy Failure Possibility: Possibility of Dummy Failure
- Collect Dump at Timeout Occurrence: Whether or not dump of monitor process is collected when timeout occurs
- Run Migration Before Run Failover: Whether or not migration is run before running failover

## Understanding HTTP monitor resources

HTTP monitor resource monitors HTTP daemon that operates on servers.

### Note on HTTP monitor resources

For the supported versions of HTTP, see the "Software Applications supported by monitoring options" in Chapter 3, "Installation requirements for EXPRESSCLUSTER" in the *Getting Started Guide*.

To monitor an HTTP server that runs in the guest OS on a virtual machine controlled by a VM resource, specify the VM resource as the monitor target and specify enough wait time for the HTTP server to become accessible after the VM resource is activated for **Wait Time to Start Monitoring**.

HTTP monitor resource does not support the client authentication.

### How HTTP monitor resources perform monitoring

HTTP monitor resource monitors the following:

Monitors the HTTP daemon by connecting to the HTTP daemon on the server and issuing a HEAD request.

This monitor resource determines the following results as an error:

- (1) an error is notified during the connection to the HTTP daemon.
- (2) the response message to the HEAD request is not started with "/HTTP"
- (3) the status code for the response to the HEAD request is in 400s and 500s (when URI other than the default is specified to the request URI)

## Displaying and changing the HTTP monitor resource details

1. Click the **Monitors** icon on the tree view displayed on the left side of the Builder window.
2. List of the monitor resources is displayed in the table view on the right side of the screen. Right-click the target HTTP monitor resource, and click the **Monitor(special)** tab in the **Monitor Resource Property** window.
3. On the **Monitor(special)** tab, you can see and/or change the detailed settings by following the description below.

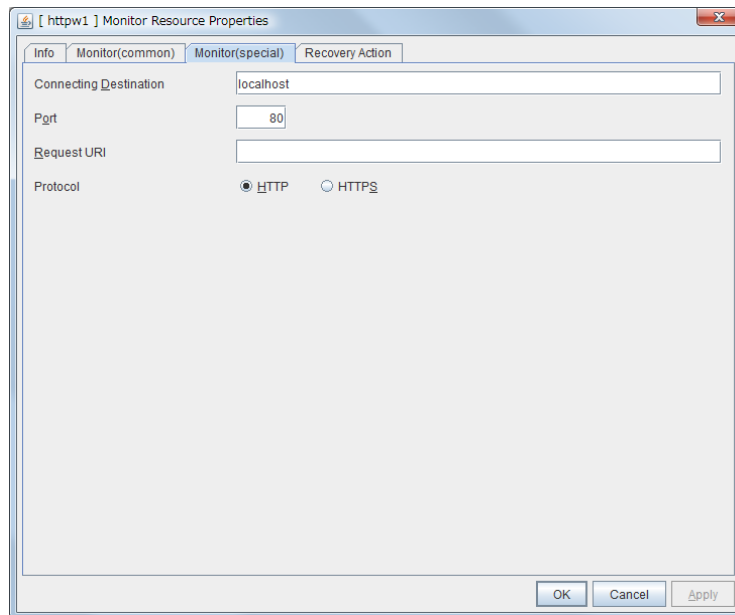

### Server Name (Within 255 bytes)

Specify the HTTP server name to be monitored. You must specify the name.

Usually, specify the loopback address (127.0.0.1) to connect to the HTTP server that runs on the local server. If the addresses for which connection is possible are limited by HTTP server settings, specify an address for which connection is possible (such as a floating IP address). To monitor an HTTP server that runs in the guest OS on a virtual machine controlled by a VM resource, specify the IP address of the virtual machine.

Default value: localhost

### Port (1 to 65535)

Specify the port number used for connecting the HTTP server. You must specify the number.

Default value: 80 (HTTP)  
443 (HTTPS)

### Request URI (Within 255 bytes)

Set the request URI (for example: “/index.html”).

Default value: None

### Protocol

Configure protocol used for communication with and HTTP server.. In general, HTTP is selected. If you need to connect with HTTP over SSL, select HTTPS.

Default value: HTTP

## Displaying the HTTP monitor resource properties with the WebManager

1. Start the WebManager.
2. When you click an object for an HTTP monitor resource  in the tree view, the following information is displayed in the list view.

HTTP Monitor Name: httpw1		Details
Common server1 server2		
Properties	Value	
Comment		
Connecting Destination	localhost	
Port	80	
Request URI		
Status	Normal	
Resource Status on Each Server		
Server Name	Status	
server1	Normal	
server2	Offline	

Comment:	Comment on the HTTP monitor resource
Connecting Destination:	HTTP server name of monitor target
Port:	Port number of the HTTP server
Request URI:	Request URI
Status:	HTTP monitor resource status
Server Name:	Server name
Status:	Status of the HTTP monitor resource



When you click **Details**, the following information is displayed in the pop-up dialog box:

Properties	Value
Name	httpw1
Type	httpw
Monitor Timing	Activating
Target Resource	exec1
Interval (sec)	60
Timeout (sec)	10
Do Not Retry at Timeout Occurrence	Off
Do Not Execute Recovery Action at Timeout Occurrence	Off
Retry Count	3
Final Action	Stop the cluster service and shutdown OS
Execute Script Before Reactivation	Off
Execute Script Before Failover	Off
Execute Script before Final Action	Off
Recovery Target	LocalServer
Recovery Target Type	Itself
Recovery Script Threshold	0
Reactivation Threshold	0
Failover Threshold	0
Wait Time to Start Monitoring (sec)	0
Nice Value	0
Monitor Suspend Possibility	Possible
Dummy Failure Possibility	Possible
Collect Dump at Timeout Occurrence	Off
Run Migration Before Run Failover	Off
Protocol	0

Name:	HTTP monitor resource name
Type:	Monitor resource type
Monitor Timing:	Timing to start monitoring
Target Resource:	Resource to be monitored
Interval (sec):	Interval between monitoring (in seconds)
Timeout (sec):	Timeout for monitoring (in seconds)
Do Not Retry at Timeout Occurrence:	Whether or not to retry when timeout occurs
Do Not Execute Recovery Action at Timeout Occurrence:	Whether or not to execute recovery action when timeout occurs
Retry Count:	The number of retries to be made from detection of an error in the monitor target to establish the error as an error
Final Action:	Final action at detection of an error
Recovery Script Execution Count:	The number of times the recovery script is executed upon the detection of an error
Execute Script before Reactivation:	Whether the pre-reactivation script is executed upon the detection of an error
Execute Script before Failover:	Whether the pre-failover script is executed upon the detection of an error
Execute Script before Final Action:	Whether the pre-final-action script is executed upon the detection of an error
Recovery Target:	Target to be recovered when an error is detected
Recovery Target Type:	Type of target to be recovered when an error is detected
Reactivation Threshold:	The number of reactivations to be made at detection of an error
Failover Threshold:	The number of failovers to be made at detection of an error
Wait Time to Start Monitoring (sec):	Time to wait before starting monitoring (in seconds)
Monitor Suspend Possibility:	Possibility of suspending monitoring
Collect Dump at Timeout Occurrence:	Whether or not dump of monitor process is collected when timeout occurs
Run Migration Before Run Failover:	Whether or not migration is run before running failover

Protocol:

Protocol used for monitoring

## Understanding IMAP4 monitor resources

IMAP4 monitor resources monitor IMAP4 services that run on the server. IMAP4 monitor resources monitor IMAP4 protocol but they are not intended for monitoring specific applications. IMAP4 monitor resources monitor various applications that use IMAP4 protocol.

### Note on IMAP4 monitor resources

For monitoring target resources, specify EXEC resources that start IMAP4 servers. Monitoring starts after a target resource is activated. However, if IMAP4 servers cannot be started immediately after a target resource is activated, adjust the time using **Wait Time to Start Monitoring**.

To monitor an IMAP4 server that runs in the guest OS on a virtual machine controlled by a VM resource, specify the VM resource as the monitor target and specify enough wait time for the IMAP4 server to become accessible after the VM resource is activated for **Wait Time to Start Monitoring**.

IMAP4 servers may produce operation logs for each monitoring. Configure IMAP4 server settings if this needs to be adjusted.

### Monitoring by IMAP4 monitor resources

IMAP4 monitor resources connect to the IMAP4 server and execute the command to verify the operation. As a result of monitoring, the following is considered as an error:

- (1) When connection to the IMAP4 server fails.
- (2) When an error is notified as a response to the command.

## Displaying and changing the IMAP4 monitor resource details

1. Click **Monitors** on the tree view displayed on the left side of the Builder window.
2. List of the monitor resources is displayed in the table view on the right side of the screen. Right click the target IMAP4 monitor resource, and click the **Monitor(special)** tab in the **Monitor Resource Property** window.
3. On the **Monitor(special)** tab, you can display and/or change the detailed settings by following the description below.

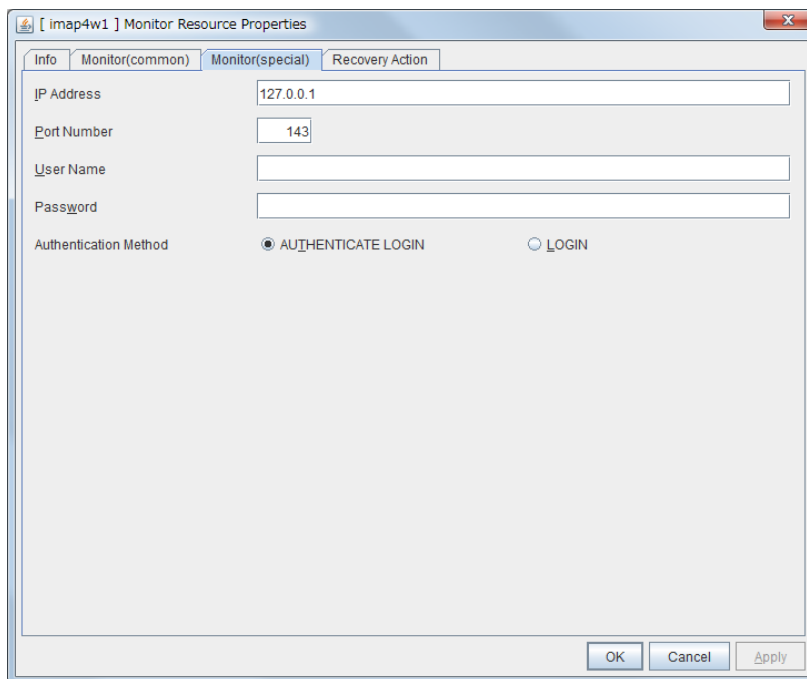

### **IP Address** (Within 79 bytes )

Specify the IP address of the IMAP4 server to be monitored. You must specify this IP address. If it is multi-directional standby server, specify FIP.

Usually, specify the loopback address (127.0.0.1) to connect to the IMAP4 server that runs on the local server. If the addresses for which connection is possible are limited by IMAP4 server settings, specify an address for which connection is possible (such as a floating IP address). To monitor an IMAP4 server that runs in the guest OS on a virtual machine controlled by a VM resource, specify the IP address of the virtual machine.

Default value: 127.0.0.1

### **Port No.** (1-65535)

Specify the port number of the IMAP4 to be monitored. You must specify this port number.

Default value: 143

**User Name** (Within 255 bytes)

Specify the user name to log on to IMAP4.

Default value: None

**Password** (Within 255 bytes)

Specify the password to log on to IMAP4. Click **Change** and then enter the password in the dialog box.

Default value: None

**Authentication Method**

Select the authentication method to log on to IMAP4. It must follow the settings of IMAP4 being used:

◆ **AUTHENTICATE LOGIN** (Default value)

The encryption authentication method that uses the AUTHENTICATE LOGIN command.

◆ **LOGIN**

The plaintext method that uses the LOGIN command.

## Displaying the IMAP4 monitor resource properties with the WebManager

1. Start the WebManager.
2. Click an IMAP4 monitor resources object, , in the tree view. The following information is displayed in the list view.

IMAP4 Monitor Name: imap4w1		Details
<span>Common</span> <span>server1</span> <span>server2</span>		
Properties	Value	
Comment		
IP Address	127.0.0.1	
Port	143	
Authority Method	AUTHENTICATE LOGIN	
Status	Normal	
Resource Status on Each Server		
Server Name	Status	
server1	Normal	
server2	Offline	

**Comment:** Comment of the IMAP monitor resource  
**IP Address:** IP address of the IMAP server to be monitored  
**Port No.:** Port number of the IMAP to be monitored  
**Certification Method** Authentication method to connect to IMAP4.  
**Status:** Status of the IMAP monitor resource

**Server Name:** Server name  
**Status:** Status of the monitor resource on the given server

When you click **Details**, the following information is displayed in the pop-up dialog box:

Properties	Value
Name	imap4w1
Type	imap4w
Monitor Timing	Activating
Target Resource	exec1
Interval (sec)	60
Timeout (sec)	120
Do Not Retry at Timeout Occurrence	Off
Do Not Execute Recovery Action at Timeout Occurrence	Off
Retry Count	3
Final Action	Stop the cluster service and shutdown OS
Execute Script Before Reactivation	Off
Execute Script Before Failover	Off
Execute Script before Final Action	Off
Recovery Target	LocalServer
Recovery Target Type	Itself
Recovery Script Threshold	0
Reactivation Threshold	0
Failover Threshold	0
Wait Time to Start Monitoring (sec)	0
Nice Value	0
Monitor Suspend Possibility	Possible
Dummy Failure Possibility	Possible
Collect Dump at Timeout Occurrence	Off
Run Migration Before Run Failover	Off

Name:	IMAP monitor resource name
Type:	Monitor resource type
Monitor Timing:	Timing to start monitoring
Target Resource:	Resource to be monitored
Interval(sec):	Interval between monitoring (in seconds)
Timeout(sec):	Timeout for monitoring (in seconds)
Do Not Retry at Timeout Occurrence:	Whether or not to retry when timeout occurs
Do Not Execute Recovery Action at Timeout Occurrence:	Whether or not to execute recovery action when timeout occurs
Retry Count:	The number of retries to be made from detection of an error in the monitor target to establish the error as error
Final Action:	Final action at detection of an error
Execute Script before Reactivation:	Whether the pre-reactivation script is executed upon the detection of an error
Execute Script before Failover:	Whether the pre-failover script is executed upon the detection of an error
Execute Script before Final Action:	Whether the pre-final-action script is executed upon the detection of an error
Recovery Target:	Target to be recovered when an error is detected
Recovery Target Type:	Type of target to be recovered when an error is detected
Recovery Script Threshold:	The number of times the recovery script is executed upon the detection of an error
Reactivation Threshold:	The number of reactivations to be made at detection of an error
Failover Threshold:	The number of failovers to be made at detection of an error
Wait Time to Start Monitoring(sec):	Time to wait before starting of monitoring (in seconds)
Nice Value:	Nice value
Monitor Suspend Possibility:	Possibility of suspending monitoring
Dummy Failure Possibility:	Possibility of Dummy Failure
Collect Dump at Timeout Occurrence:	Whether or not dump of monitor process is collected when timeout occurs
Run Migration Before Run Failover:	Whether or not migration is run before running failover

## Understanding MySQL monitor resources

MySQL monitor resource monitors MySQL database that operates on servers.

### Note on MySQL monitor resources

For the supported versions of MySQL, see "Software Applications supported by monitoring options" in Chapter 3, "Installation requirements for EXPRESSCLUSTER" in the *Getting Started Guide*.

This monitor resource monitors MySQL using the libmysqlclient library of MySQL.

If this monitor resource fails, check that "libmysqlclient.so.xx" exists in the installation directory of the MySQL library.

To monitor a MySQL database that runs in the guest OS on a virtual machine controlled by a VM resource, specify the VM resource as the monitor target and specify enough wait time for the MySQL database to become accessible after the VM resource is activated for **Wait Time to Start Monitoring**.

If a value specified by a parameter differs from the MySQL environment for monitoring, an error message is displayed on the WebManager alert view. Check the environment.

If "Level 1" or "Level 2" is selected as a monitor level described in the next subsection "How MySQL monitor resources perform monitoring", monitor tables must be created manually beforehand.

A monitor error occurs if there is no monitor table at the start of monitoring in "Level 1".

If there is no monitor table at the start of monitoring in "Level 2", EXPRESSCLUSTER automatically creates the monitor table. In this case, a message indicating that the WebManager alert view does not have the monitor table is displayed.

The load on the monitor at "Level 3" is higher than that at "Level 1" and "Level 2" because the monitor in "Level 3" creates or deletes monitor tables for each monitoring.

Selectable monitor level	Prior creation of a monitor table
Level 1 (monitoring by select)	Required
Level 2 (monitoring by update/select)	Required
Level 3 (create/drop table each time)	Optional

Create a monitor table using either of the following methods:

**Use SQL statements (in the following example, the monitor table is named mysqlwatch)**

```
sql> create table mysqlwatch (num int not null primary key) ENGINE=<engine>;
sql> insert into mysqlwatch values(0);
sql> commit;
```

**Use EXPRESSCLUSTER commands**

```
clp_mysqlw --createtable -n <MySQL_monitor_resource_name>
```

To manually delete a monitor table, execute the following command:

```
clp_mysqlw --deletetable -n <MySQL_monitor_resource_name>
```



## How MySQL monitor resources perform monitoring

MySQL monitor resources perform monitoring according to the specified monitor level.

- ◆ Level 1 (monitoring by select)

Monitoring with only reference to the monitor table. SQL statements executed for the monitor table are of (select) type.

An error is recognized if:

(1) An error message is sent in response to a database connection or SQL statement message

- ◆ Level 2 (monitoring by update/select)

Monitoring with reference to and update of the monitoring table. One SQL statement can read/write numerical data of up to 11 digits. SQL statements executed for the monitor table are of (update/select) type.

If a monitor table is automatically created at the start of monitoring, the SQL statement (create/insert) is executed for the monitor table.

An error is recognized if:

(1) An error message is sent in response to a database connection or SQL statement message

(2) The written data is not the same as the read data

- ◆ Level 3 (create/drop table each time)

Creation/deletion of the monitor table by statement as well as update. One SQL statement can read/write numerical data of up to 11 digits. SQL statements executed for the monitor table are of (create / insert / select / drop) type.

An error is recognized if:

(1) An error message is sent in response to a database connection or SQL statement message

(2) The written data is not the same as the read data

## Displaying and changing the MySQL monitor resource details

1. Click the **Monitors** icon on the tree view displayed on the left side of the Builder window.
2. List of the monitor resources is displayed in the table view on the right side of the screen. Right-click the target MySQL monitor resource, and click the **Monitor(special)** tab in the **Monitor Resource Property** window.
3. On the **Monitor(special)** tab, you can see and/or change the detailed settings by following the description below.

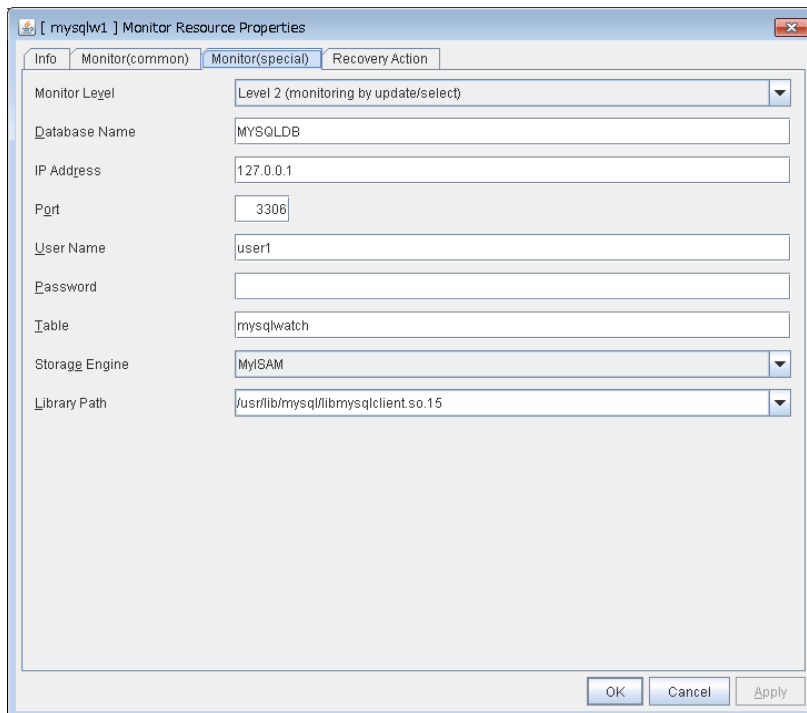

### Monitor Level

Select one of the following levels. You cannot omit this level setting.

- ◆ Level 1 (monitoring by select)  
Monitoring with only reference to the monitor table. SQL statements executed for the monitor table are of (select) type.
- ◆ Level 2 (monitoring by update/select)  
Monitoring with reference to and update of the monitoring table. SQL statements executed for the monitor table are of (update/select) type.  
  
If a monitor table is automatically created at the start of monitoring, the SQL statement (create/insert) is executed for the monitor table.
- ◆ Level 3 (create/drop table each time)  
Creation/deletion of the monitor table by statement as well as update. SQL statements executed for the monitor table are of (create / insert / select / drop) type.

Default: Level 2 (monitoring by update/select)

### Database Name (Within 255 bytes)

Specify the database name to be monitored. You must specify the name.

Default value: None

**IP Address** (Within 79 bytes)

Specify the IP address of the server to connect. You must specify the IP address.

Usually, specify the loopback address (127.0.0.1) to connect to the MySQL server that runs on the local server. To monitor a MySQL database that runs in the guest OS on a virtual machine controlled by a VM resource, specify the IP address of the virtual machine.

Default value: 127.0.0.1

**Port** 1 to 65535

Specify the port number used for connection. You must specify the port number.

Default value: 3306

**User Name** (Within 255 bytes)

Specify the user name to log on to the database. You must specify the name.

Specify the MySQL user who can access the specified database.

Default value: None

**Password** (Within 255 bytes)

Specify the password to log on to the database.

Default value: None

**Table** (Within 255 bytes)

Specify the name of a monitor table created in the database. You must specify the name.

Make sure not to specify the same name as the table used for operation because a monitor table will be created and deleted. Make sure to set the name different from the reserved word in SQL statements.

Some characters cannot be used to specify a monitor table name according to the database specifications. For details, refer to the database.

Default value: mysqlwatch

**Storage Engine**

Specify the storage engine of MySQL. You must specify the storage engine.

Default value: MyISAM

**Library Path** (Within 1023 bytes)

Specify the home path to MySQL. You must specify the path.

Default value: /usr/lib/mysql/libmysqlclient.so.15

## Displaying the MySQL monitor resource properties with the WebManager

1. Start the WebManager.
2. When you click an object for a MySQL monitor resource  in the tree view, the following information is displayed in the list view.

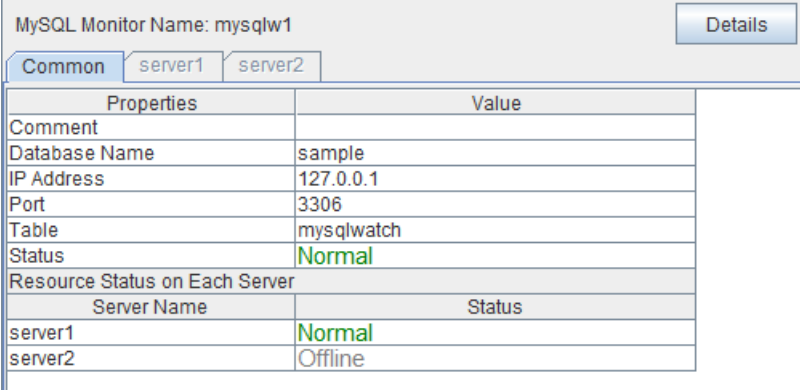

Properties	Value
Comment	
Database Name	sample
IP Address	127.0.0.1
Port	3306
Table	mysqlwatch
Status	Normal
Resource Status on Each Server	
Server Name	Status
server1	Normal
server2	Offline

Comment:	Comment on the MySQL monitor resource
Database Name:	Monitor target database name
IP Address:	IP address for connecting MySQL server
Port:	Port number of MySQL
Table:	Table name for monitoring created on a database
Status:	MySQL monitor resource status
Server Name:	Server name
Status:	Status of the monitor resource on the server

When you click **Details**, the following information is displayed in the pop-up dialog box:

Properties	Value
Name	mysqlw1
Type	mysqlw
Monitor Timing	Activating
Target Resource	exec1
Interval (sec)	60
Timeout (sec)	120
Do Not Retry at Timeout Occurrence	Off
Do Not Execute Recovery Action at Timeout Occurrence	Off
Retry Count	2
Final Action	Stop the cluster service and shutdown OS
Execute Script Before Reactivation	Off
Execute Script Before Failover	Off
Execute Script before Final Action	Off
Recovery Target	failover1
Recovery Target Type	Group
Recovery Script Threshold	0
Reactivation Threshold	0
Failover Threshold	1
Wait Time to Start Monitoring (sec)	0
Nice Value	0
Monitor Suspend Possibility	Possible
Dummy Failure Possibility	Possible
Collect Dump at Timeout Occurrence	Off
Run Migration Before Run Failover	Off
Storage Engine	MyISAM
Library Path	/usr/lib/mysql/libmysqlclient.so.15
Monitor Action	Level 2 (monitoring by update/select)

- Name: MySQL monitor resource name
- Type: Monitor resource type
- Monitor Timing: Timing to start monitoring
- Target Resource: Resource to be monitored
- Interval (sec): Interval between monitoring (in seconds)
- Timeout (sec): Timeout for monitoring (in seconds)
- Do Not Retry at Timeout Occurrence: Whether or not to retry when timeout occurs
- Do Not Execute Recovery Action at Timeout Occurrence: Whether or not to execute recovery action when timeout occurs
- Retry Count: The number of retries to be made from detection of an error in the monitor target to establish the error as an error
- Final Action: Final action at detection of an error
- Execute Script before Reactivation: Whether the pre-reactivation script is executed upon the detection of an error
- Execute Script before Failover: Whether the pre-failover script is executed upon the detection of an error
- Execute Script before Final Action: Whether the pre-final-action script is executed upon the detection of an error
- Recovery Target: Target to be recovered when an error is detected
- Recovery Target Type: Type of target to be recovered when an error is detected
- Recovery Script Threshold: The number of times the recovery script is executed upon the detection of an error
- Reactivation Threshold: The number of reactivations to be made at detection of an error
- Failover Threshold: The number of failovers to be made at detection of an error
- Wait Time to Start Monitoring (sec): Time to wait before starting monitoring (in seconds)
- Nice Value: Monitor resource nice value
- Monitor Suspend Possibility: Possibility of suspending monitoring
- Dummy Failure Possibility: Possibility of Dummy Failure

Collect Dump at Timeout Occurrence:	Whether or not dump of monitor process is collected when timeout occurs
Run Migration Before Run Failover:	Whether or not migration is run before running failover
Storage Engine:	Storage engine of MySQL
Library Path:	Library path of MySQL
Monitor Action:	Monitor level

## Understanding NFS monitor resources

NFS monitor resource monitors NFS file server that operates on servers.

### System requirements for NFS monitor resource

The use of NFS monitor resources requires that the following already be started:

<For Red Hat Enterprise Linux 5 >

- nfs
- portmap
- nfslock (unnecessary for NFS v4)

< For Red Hat Enterprise Linux 6, 7 >

- nfs
- rpcbind
- nfslock (unnecessary for NFS v4)

### Note on NFS monitor resources

For the supported versions of NFS, see "Software Applications supported by monitoring options" in Chapter 3, "Installation requirements for EXPRESSCLUSTER" in the *Getting Started Guide*.

Specify the exports file for the shared directory to be monitored to enable the connection from a local server.

To monitor an NFS file server that runs in the guest OS on a virtual machine controlled by a VM resource, specify the VM resource as the monitor target and specify enough wait time for the NFS file server to become accessible after the VM resource is activated for **Wait Time to Start Monitoring**.

It is handled as an error that the deletion of nfsd with the version specified for **NFS version** of the **Monitor(special)** tab and mountd corresponding the nfsd is detected. The correspondence between nfsd versions and mountd versions is as follows.

nfsd version	mountd version
v2 (udp)	v1 (tcp) or v2 (tcp)
v3 (udp)	v3 (tcp)
v4 (tcp)	-

### How NFS monitor resources perform monitoring

NFS monitor resource monitors the following:

Connect to the NFS server and run NFS test command.

This monitor resource determines the following result as an error:

<For Red Hat Enterprise Linux 5 >

- (1) Response to the NFS service request is invalid
- (2) mountd is deleted (excluding NFS v4)
- (3) nfsd is deleted
- (4) The portmap service is stopped
- (5) The export area is deleted(unnecessary for NFS v4)

<For Red Hat Enterprise Linux 6, 7>

- (1) Response to the NFS service request is invalid
- (2) mountd is deleted (excluding NFS v4)
- (3) nfsd is deleted
- (4) The rpcbind service is stopped
- (5) The export area is deleted(unnecessary for NFS v4)

When an error is repeated the number of times set to retry count, it is considered as NFS error.

## Displaying and changing the NFS monitor resource details

1. Click the **Monitors** icon on the tree view displayed on the left side of the Builder window.
2. List of the monitor resources is displayed in the table view on the right side of the screen. Right-click the target NFS monitor resource, and click the **Monitor(special)** tab in the **Monitor Resource Property** window.
3. On the **Monitor(special)** tab, you can see and/or change the detailed settings by following the description below.

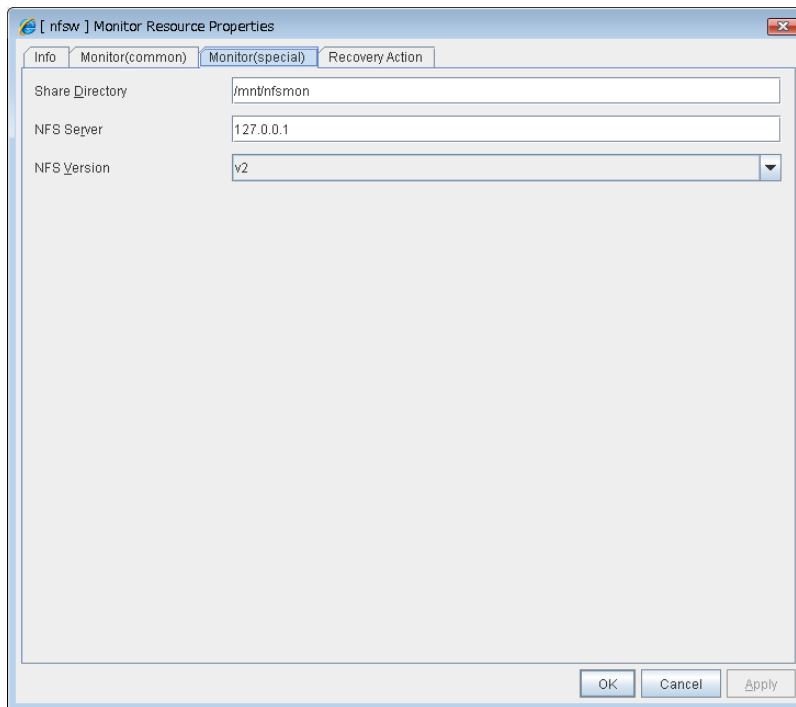

**Share Directory** (Within 1023 bytes)

Specify a directory for sharing files. You must specify the directory.



Default value: None

**NFS Server** (Within 79 bytes)

Specify an IP address of the server that monitors NFS. You must specify the IP address.

Usually, specify the loopback address (127.0.0.1) to connect to the NFS file server that runs on the local server. To monitor an NFS file server that runs in the guest OS on a virtual machine controlled by a VM resource, specify the IP address of the virtual machine.

Default value: 127.0.0.1

**NFS Version**

Select one NFS version for NFS monitoring, from the following choices. Be careful to set this NFS version.

For RHEL 7, the NFS version v2 is not supported.

- ◆ v2  
Monitors NFS version v2.
- ◆ v3  
Monitors NFS version v3.
- ◆ v4  
Monitors NFS version v4.

Default value: v2

## Displaying the NFS monitor resource properties with the WebManager

1. Start the WebManager.
2. When you click an object for a NFS monitor resource  in the tree view, the following information is displayed in the list view.

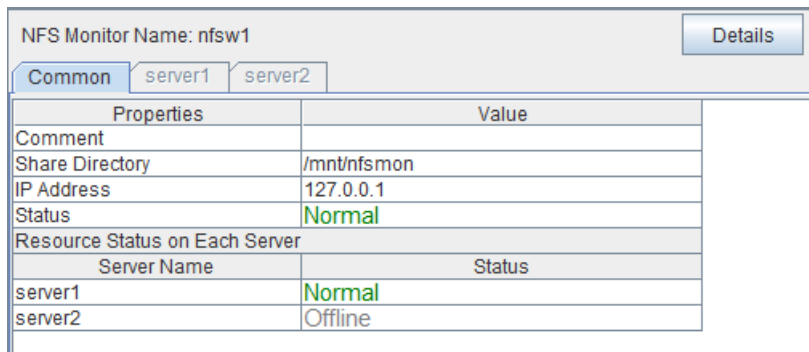

Properties	Value
Comment	
Share Directory	/mnt/nfsmon
IP Address	127.0.0.1
Status	Normal
Resource Status on Each Server	
Server Name	Status
server1	Normal
server2	Offline

Comment: Comment on the NFS monitor resource  
 Share Directory: Shared name that NFS server exports  
 IP Address: IP address for connecting NFS server  
 Status: NFS monitor resource status

Server Name: Server name  
 Status: Status of the monitor resource on the server

When you click **Details**, the following information is displayed in the pop-up dialog box:

Properties	Value
Name	nfs1
Type	nfs
Monitor Timing	Activating
Target Resource	exec1
Interval (sec)	30
Timeout (sec)	60
Do Not Retry at Timeout Occurrence	Off
Do Not Execute Recovery Action at Timeout Occurrence	Off
Retry Count	5
Final Action	Stop the cluster service and shutdown OS
Execute Script Before Reactivation	Off
Execute Script Before Failover	Off
Execute Script before Final Action	Off
Recovery Target	LocalServer
Recovery Target Type	Itself
Recovery Script Threshold	0
Reactivation Threshold	0
Failover Threshold	0
Wait Time to Start Monitoring (sec)	0
Nice Value	0
Monitor Suspend Possibility	Possible
Dummy Failure Possibility	Possible
Collect Dump at Timeout Occurrence	Off
Run Migration Before Run Failover	Off

- Name: NFS monitor resource name
- Type: Monitor resource type
- Monitor Timing: Timing to start monitoring
- Target Resource: Resource to be monitored
- Interval (sec): Interval between monitoring (in seconds)
- Timeout (sec): Timeout for monitoring (in seconds)
- Do Not Retry at Timeout Occurrence: Whether or not to retry when timeout occurs
- Do Not Execute Recovery Action at Timeout Occurrence: Whether or not to execute recovery action when timeout occurs
- Retry Count: The number of retries to be made from detection of an error in the monitor target to establish the error as an error
- Final Action: Final action at detection of an error
- Execute Script before Reactivation: Whether the pre-reactivation script is executed upon the detection of an error
- Execute Script before Failover: Whether the pre-failover script is executed upon the detection of an error
- Execute Script before Final Action: Whether the pre-final-action script is executed upon the detection of an error
- Recovery Target: Target to be recovered when an error is detected
- Recovery Target Type: Type of target to be recovered when an error is detected
- Recovery Script Threshold: The number of times the recovery script is executed upon the detection of an error
- Reactivation Threshold: The number of reactivations to be made at detection of an error
- Failover Threshold: The number of failovers to be made at detection of an error
- Wait Time to Start Monitoring (sec): Time to wait before starting monitoring (in seconds)
- Nice Value: Monitor resource nice value
- Monitor Suspend Possibility: Possibility of suspending monitoring
- Dummy Failure Possibility: Possibility of Dummy Failure
- Collect Dump at Timeout Occurrence: Whether or not dump of monitor process is collected when timeout occurs

Run Migration Before Run Failover: Whether or not migration is run before running failover

## Understanding Oracle monitor resources

Oracle monitor resource monitors Oracle database that operates on servers.

### Note on Oracle monitor resources

For the supported versions of Oracle, see “Software Applications supported by monitoring options” in Chapter 3, “Installation requirements for EXPRESSCLUSTER” in the *Getting Started Guide*.

This monitor resource monitors Oracle with the Oracle interface (Oracle Call Interface). For this reason, the library for interface (libclntsh.so) needs to be installed on the server for monitoring.

To monitor an Oracle database that runs in the guest OS on a virtual machine controlled by a VM resource, specify the VM resource as the monitor target and specify enough wait time for the Oracle database to become accessible after the VM resource is activated for **Wait Time to Start Monitoring**. Also, set up the Oracle client on the host OS side, where monitor resources run, and specify the connection string for connecting to the Oracle database on the virtual machine.

If values of a connection string, user name and password specified by a parameter are different from the Oracle environment for monitoring, Oracle monitoring cannot be done. Error message is displayed. Check the environment.

For the user specified with the user name parameter, the default is sys, but when a monitoring-dedicated user has been configured, for each monitor level the following access permissions must be provided for that user (if the sysdba permission is not provided):

Monitor level	Necessary permissions
Level 0 (database status)	SELECT permission for V\$INSTANCE
Level 1 (monitoring by select)	SELECT permission for a monitor table
Level 2 (monitoring by update/select)	CREATE TABLE / DROP ANY TABLE / INSERT permission for a monitor table / UPDATE permission for a monitor table /SELECT permission for a monitor table
Level 3 (create/drop table each time)	CREATE TABLE / DROP ANY TABLE / INSERT permission for a monitor table / UPDATE permission for a monitor table /SELECT permission for a monitor table

If the administrator user authentication method is only the OS authentication by setting “NONE” to “REMOTE\_LOGIN\_PASSWORDFILE” in the initialization parameter file, specify a database user without SYSDBA authority for the user name of the parameter.

When specifying a database user with SYSDBA authority, an error occurs when this monitor resource starts, causing the monitoring process not to be executed.

If sys is specified for the user name, an Oracle audit log may be output. If you do not want to output large audit logs, specify a user name other than sys.

Use the character set supported by OS when creating a database.

If Japanese is set to NLS\_LANGUAGE in the Oracle initialization parameter file, specify English by NLS\_LANG (environment variable of Oracle.) Specify the character set corresponds to the database.

Select the language displayed in the EXPRESSCLUSTER Web Manager alert viewer and OS messages (syslog) for the character code of the monitor resource if an error message is generated from Oracle..

However, as for an error of when connecting to the database such as incorrect user name and alert message may not be displayed correctly.

For the NLS parameter and NLS\_LANG settings, see the *Globalization Support Guide* by Oracle Corporation.

The character code settings have no effect on the operation of Oracle..

If “Level 1” or “Level 2” is selected as a monitor level described in the next subsection “How Oracle monitor resources perform monitoring”, monitor tables must be created manually beforehand.

A monitor error occurs if there is no monitor table at the start of monitoring in “Level 1”. If there is no monitor table at the start of monitoring in “Level 2”, EXPRESSCLUSTER automatically creates the monitor table. In this case, a message indicating that the WebManager alert view does not have the monitor table is displayed.

Selectable monitor level	Prior creation of a monitor table
Level 0 (database status)	Optional
Level 1 (monitoring by select)	Required
Level 2 (monitoring by update/select)	Required
Level 3 (create/drop table each time)	Optional

Create a monitor table using either of the following methods:

**When creating by SQL statements (in the following example, the monitor table is named orawatch)**

```
sql> create table orawatch (num number(11,0) primary key);
sql> insert into orawatch values(0);
sql> commit;
```

\*Create this in a schema for the user specified with the user name parameter.

**When using EXPRESSCLUSTER commands**

```
clp_oraclew --createtable -n <Oracle monitor resource name>
```

\*When the user other than sys is specified for the user name parameter and the sysdba permission is not provided for that user, CREATE TABLE permission is required for that user.

When deleting the created monitor table manually, run the following command:

```
clp_oraclew --deletetable -n <Oracle monitor resource name>
```

The load on the monitor at “Level 3” is higher than that at “Level 1” and “Level 2” because the monitor in “Level 3” creates or deletes monitor tables for each monitoring. In addition, the Oracle resource usage continues to increase. Therefore, it is not recommended to perform monitoring at “Level 3” during usual operations, except for an operation in which an Oracle instance is periodically restarted.

## How Oracle monitor resources perform monitoring

Oracle monitor resources perform monitoring according to the specified monitor level.

◆ Level 0 (database status)

The Oracle management table (V\$INSTANCE table) is referenced to check the DB status (instance status). This level corresponds to simplified monitoring without SQL statements being executed for the monitor table.

An error is recognized if:

(1) The Oracle management table (V\$INSTANCE table) status is in the inactive state (MOUNTED,STARTED)

(2) The Oracle management table (V\$INSTANCE table) database\_status is in the inactive state (SUSPENDED,INSTANCE RECOVERY)

◆ Level 1 (monitoring by select)

Monitoring with only reference to the monitor table. SQL statements executed for the monitor table are of (select) type.

An error is recognized if:

(1) An error message is sent in response to a database connection or SQL statement message

◆ Level 2 (monitoring by update/select)

Monitoring with reference to and update of the monitoring table. One SQL statement can read/write numerical data of up to 11 digits. SQL statements executed for the monitor table are of (update/select) type.

If a monitor table is automatically created at the start of monitoring, the SQL statement (create/insert) is executed for the monitor table.

An error is recognized if:

(1) An error message is sent in response to a database connection or SQL statement message

(2) The written data is not the same as the read data

◆ Level 3 (create/drop table each time)

Creation/deletion of the monitor table by statement as well as update. One SQL statement can read/write numerical data of up to 11 digits. SQL statements executed for the monitor table are of (create / insert / select / drop) type.

An error is recognized if:

(1) An error message is sent in response to a database connection or SQL statement message

(2) The written data is not the same as the read data

## Displaying and changing the Oracle monitor resource details

1. Click the **Monitors** icon on the tree view displayed on the left side of the Builder window.
2. List of the monitor resources is displayed in the table view on the right side of the screen. Right-click the target Oracle monitor resource, and click the **Monitor(special)** tab in the **Monitor Resource Property** window.
3. On the **Monitor(special)** tab, you can see and/or change the detailed settings by following the description below.

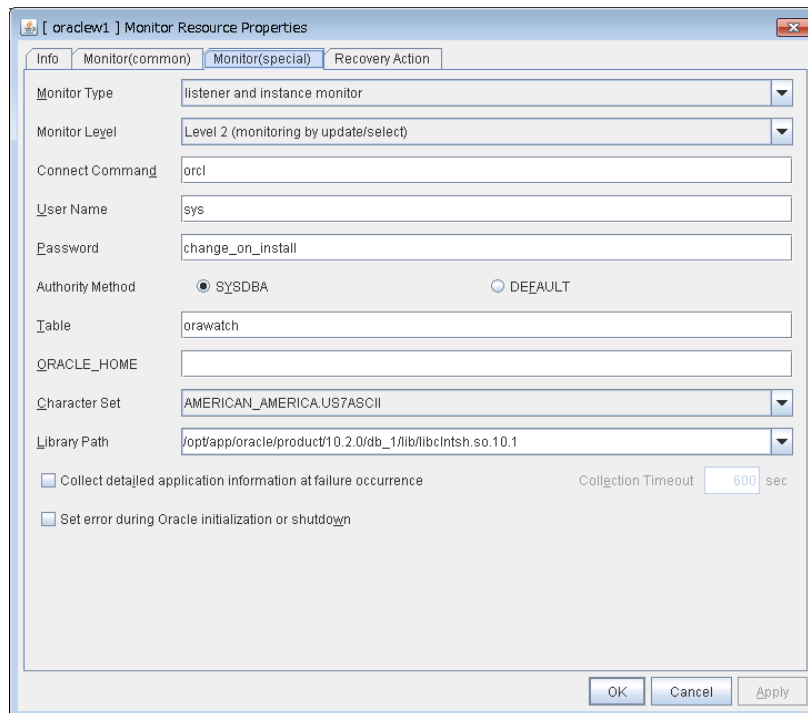

### Monitor Type

Select the Oracle features to be monitored.

- ◆ **Monitor Listener and Instance (default)**

According to the specified monitor level, database connection, reference, and update operations are monitored.

- ◆ **Monitor Listener only**

To check for the listener operation, use the `tnsping Oracle` command. For a monitor resource property, `ORACLE_HOME` must be set.

If `ORACLE_HOME` is not set, only connection operations for the items specified in the connect string are monitored. Use this to attempt recovery by restarting the Listener service upon a connection error.

Selecting this setting causes the monitor level setting to be ignored.

- ◆ **Monitor Instance only**

A direction (BEQ) connection to the database is established, bypassing the listener and, according to the specified monitor level, database connection, reference, and update operations are monitored. For a monitor resource property, `ORACLE_HOME` must be set.



This is used for direct instance monitoring and recovery action setting without routing through the listener.

When the monitoring target is a database that has an Oracle12c multi-tenant configuration, monitoring using BEQ connection cannot be performed.

If ORACLE\_HOME is not set, only the connection specified with the connect string is established, and any error in the connection operation is ignored. This is used to set the recovery action for a non-connection error together with an Oracle monitor resource for which **Monitor Listener only** is specified.

**Monitor Level**

Select one of the following levels. When the monitor type is set to **Monitor Listener only**, the monitor level setting is ignored.

◆ Level 0 (database status)

The Oracle management table (V\$INSTANCE table) is referenced to check the DB status (instance status). This level corresponds to simplified monitoring without SQL statements being executed for the monitor table.

◆ Level 1 (monitoring by select)

Monitoring with only reference to the monitor table. SQL statements executed for the monitor table are of (select) type.

◆ Level 2 (monitoring by update/select)

Monitoring with reference to and update of the monitoring table. SQL statements executed for the monitor table are of (update/select) type.

If a monitor table is automatically created at the start of monitoring, the SQL statement (create/insert) is executed for the monitor table.

◆ Level 3 (create/drop table each time)

Creation/deletion of the monitor table by statement as well as update. SQL statements executed for the monitor table are of (create / insert / select / drop) type.

Default: Level 2 (monitoring by update/select)

**Connect Command** (Within 255 bytes)

Specify the connect string for the database to be monitored. You must specify the connect string.

When **Monitor Type** is set to **Monitor Instance only**, set ORACLE\_SID.

Monitor Type	ORACLE_HOME	Connect Command	Monitor Level
Monitor Listener and Instance	Need not be specified	Specify the connect string	As specified
Monitor Listener only	Monitoring dependent on Oracle command if specified	Specify the connect string	Ignored
	Check for connection to the instance through the listener if not specified	Specify the connect string	Ignored
Monitor Instance only	Check for the instance by BEQ connection if specified	Specify ORACLE_SID	As specified
	Check for the instance through the listener if not specified	Specify the connect string	As specified

Default value: None for the connect string

**User Name** (Within 255 bytes)

Specify the user name to log on to the database. You must specify the name.

Specify the Oracle user who can access the specified database.

Default value: sys

**Password** (Within 255 bytes)

Specify the password to log on to the database.

Default value: change\_on\_install

**Authority**

Specify the database user authentication.

Default value: SYSDBA

**Table** (Within 255 bytes)

Specify the name of a monitor table created on the database. You must specify the name.

Make sure not to specify the same name as the table used for operation because a monitor table will be created and deleted. Be sure to set the name different from the reserved word in SQL statements.

Some characters cannot be used to specify a monitor table name according to the database specifications. For details, refer to the database.

Default value: orawatch

**ORACLE\_HOME** (Within 255 bytes)

Specify the path name configured in ORACLE\_HOME. Begin with [/]. This is used when **Monitor Type** is set to **Monitor Listener only** or **Monitor Instance only**.

Default: None

**Character Set**

Specify the character set of Oracle. You must specify the character code.

Default value: None

**Library Path** (Within 1023 bytes)

Specify the library path of Oracle Call Interface (OCI). You must specify the path.

Default value: /opt/app/oracle/product/10.2.0/db\_1/lib/libclntsh.so.10.1

**Collect detailed application information at failure occurrence**

In case that this function is enabled, when Oracle monitor resource detects errors, the detailed Oracle information is collected. The collected information is written to the /opt/nec/clusterpro/work/rm/ "monitor\_resource\_name"/errinfo.cur folder. When the information is obtained more than once, the existing folders are renamed errinfo.1, errinfo.2, and so on. The detailed Oracle information is collected up to 5 times.

---

**Note:**

In case of stopping the Oracle service while collecting the information due to the cluster stop, correct information may not be collected.

---

Default value: disabled

**Collection Timeout**

Specify the timeout value for collecting detailed information.

Default value: 600

**Set error during Oracle initialization or shutdown**

If this function is enabled, a monitor error occurs immediately when Oracle start or shutdown in progress is detected.

Disable this function when Oracle is automatically restarted during operation in cooperation with Oracle Clusterware or the like. Monitoring becomes normal even during Oracle start or shutdown. However, a monitor error occurs if Oracle start or shutdown continues for one hour or more.

Default value: Disabled

## Displaying the Oracle monitor resource properties with the WebManager

1. Start the WebManager.
2. When you click an object for Oracle monitor resource  in the tree view, the following information is displayed in the list view.

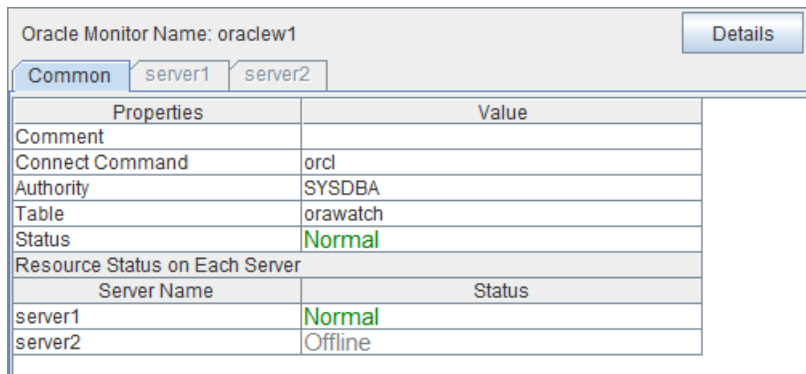

Oracle Monitor Name: oraclew1		Details
<span>Common</span> <span>server1</span> <span>server2</span>		
Properties	Value	
Comment		
Connect Command	orcl	
Authority	SYSDBA	
Table	orawatch	
Status	Normal	
Resource Status on Each Server		
Server Name	Status	
server1	Normal	
server2	Offline	

Comment:	Comment on the Oracle monitor resource
Connect Command:	Connect command corresponding to a database to be monitored
Authority:	Authority when accessing a database
Table:	Monitor table name created on a database
Status:	Oracle monitor resource status
Server Name:	Server name
Status:	Status of the monitor resource on the server

When you click **Details**, the following information is displayed in the pop-up dialog box:

Properties	Value
Name	oraclew1
Type	oraclew
Monitor Timing	Activating
Target Resource	exec1
Interval (sec)	60
Timeout (sec)	120
Do Not Retry at Timeout Occurrence	Off
Do Not Execute Recovery Action at Timeout Occurrence	Off
Retry Count	2
Final Action	Stop the cluster service and shutdown OS
Execute Script Before Reactivation	Off
Execute Script Before Failover	Off
Execute Script before Final Action	Off
Recovery Target	failover1
Recovery Target Type	Group
Recovery Script Threshold	0
Reactivation Threshold	0
Failover Threshold	1
Wait Time to Start Monitoring (sec)	0
Nice Value	0
Monitor Suspend Possibility	Possible
Dummy Failure Possibility	Possible
Collect Dump at Timeout Occurrence	Off
Run Migration Before Run Failover	Off
Character Set	AMERICAN_AMERICA.US7ASCII
Library Path	/opt/app/oracle/product/10.2.0/db_1/lib/libclntsh.so.10.1
Monitor Method	listener and instance monitor
Monitor Action	Level 2 (monitoring by update/select)
ORACLE HOME	

- Name: Oracle monitor resource name
- Type: Monitor resource type
- Monitor Timing: Timing to start monitoring
- Target Resource: Resource to be monitored
- Interval (sec): Interval between monitoring (in seconds)
- Timeout (sec): Timeout for monitoring (in seconds)
- Do Not Retry at Timeout Occurrence: Whether or not to retry when timeout occurs
- Do Not Execute Recovery Action at Timeout Occurrence: Whether or not to execute recovery action when timeout occurs
- Retry Count: The number of retries to be made from detection of an error in the monitor target to establish the error as an error
- Final Action: Final action at detection of an error
- Execute Script before Reactivation: Whether the pre-reactivation script is executed upon the detection of an error
- Execute Script before Failover: Whether the pre-failover script is executed upon the detection of an error
- Execute Script before Final Action: Whether the pre-final-action script is executed upon the detection of an error
- Recovery Target: Target to be recovered when an error is detected
- Recovery Target Type: Type of target to be recovered when an error is detected
- Recovery Script Threshold: The number of times the recovery script is executed upon the detection of an error
- Reactivation Threshold: The number of reactivations to be made at detection of an error
- Failover Threshold: The number of failovers to be made at detection of an error
- Wait Time to Start Monitoring (sec): Time to wait before starting monitoring (in seconds)
- Nice Value: Monitor resource nice value

Monitor Suspend Possibility:	Possibility of suspending monitoring
Dummy Failure Possibility	Possibility of Dummy Failure
Collect Dump at Timeout Occurrence:	Whether or not dump of monitor process is collected when timeout occurs
Run Migration Before Run Failover:	Whether or not migration is run before running failover
Character Set:	Character set of Oracle
Library Path:	Library path of Oracle
Monitor Method:	The method for monitoring Oracle
Monitor Action:	Monitor level
ORACLE_HOME	ORACLE_HOME path name

## Understanding OracleAS monitor resources

OracleAS monitor resource monitors Oracle application server that operates on servers.

### Notes on OracleAS monitor resources

For the supported versions of the Oracle application server, see “Software Applications supported by monitoring options” in Chapter 3, “Installation requirements for EXPRESSCLUSTER” in the *Getting Started Guide*.

For the monitor target resource, specify EXEC resources etc. to start Oracle application server. Monitoring starts after the target resource is activated. If the Oracle application server cannot operate immediately after the target resource is activated, adjust the time by **Wait Time to Start Monitoring**.

If there is any component which does not start in Oracle application server instance when monitor target resources are activated, edit opmn.xml file to change the status of the component to “disabled”. For details on opmn.xml file, refer to Oracle application server manual.

Oracle application server itself may report operation logs etc. for every monitoring operation. To control this, configure the settings in Oracle application server accordingly.

### How OracleAS monitor resources perform monitoring

OracleAS monitor resource monitors the following:

It uses the OracleAS opmnctl command to monitor the application server.

OracleAS monitor resource determines the following result as an error:

- (1) When an error is informed in the status of the acquired application server

## Displaying and changing the OracleAS monitor resource details

1. Click the **Monitors** icon on the tree view displayed on the left side of the Builder window.
2. List of the monitor resources is displayed in the table view on the right side of the screen. Right-click the target OracleAS monitor resource, and click the **Monitor(special)** tab in the **Properties** window.
3. On the **Monitor(special)** tab, you can see and/or change the detailed settings by following the description below.

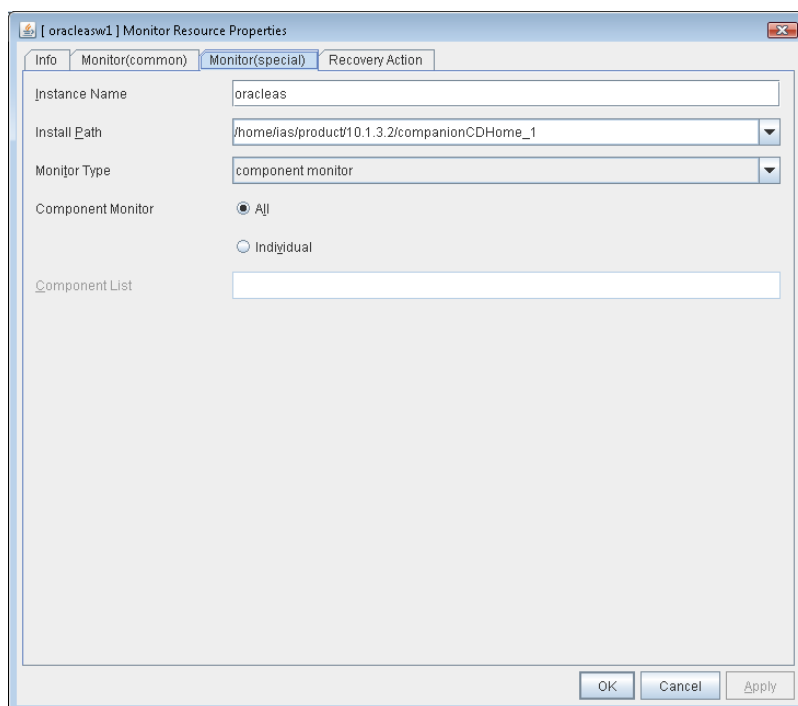

### Instance name (Within 255 bytes)

Specify the instance to be monitored. You must specify the instance.

Default value: None

### Install path (Within 1023 bytes)

Specify the install path to the Oracle application. You must specify the path.

Default value: /home/ias/product/10.1.3.2/companionCDHome\_1

### Monitor Type

Select the Oracle application server features to be monitored.

- ◆ Monitor both opmn process and component simultaneously  
Both opmn process activation/deactivation monitoring and component status monitoring are performed.
- ◆ Monitor opmn process only  
Only opmn process activation/deactivation monitoring is performed.
- ◆ Monitor component only (default)



Only component status monitoring is performed.

### **Component Monitor**

Select whether you specify monitor target component individually when **Monitor both opmn process and component simultaneously** or **Component Monitor** is selected as Monitor Type.

◆ **All** (default)

All components are monitored.

◆ **Individual**

Only the component specified in **Component List**.

### **Component List** (Within 1023 byte)

Enter a target component name of **Monitor Component**. If you want to specify two or more components, separate them by comma “,”. Make sure to set this when **Individual** is selected in **Component Monitor**.

## Displaying and changing the OracleAS monitor resource properties with the WebManager

1. Start the WebManager.
2. When you click an object for OracleAS monitor resource  in the tree view, the following information is displayed in the list view.

OracleAS Monitor Name: oracleasw1		Details
Common		server1
server2		
Properties	Value	
Comment		
Instance	oracleas	
Status	Normal	
Resource Status on Each Server		
Server Name	Status	
server1	Normal	
server2	Offline	

Comment	OracleAS monitor resource comment
Instance name	Name of the instance to be monitored
Status	Status of the OracleAS monitor resource
Server Name	Server name
Status:	Status of the monitor resource on the server

When you click **Details**, the following information is displayed in the pop-up dialog box:

Properties	Value
Name	oracleasw1
Type	oracleasw
Monitor Timing	Activating
Target Resource	exec1
Interval (sec)	60
Timeout (sec)	120
Do Not Retry at Timeout Occurrence	Off
Do Not Execute Recovery Action at Timeout Occurrence	Off
Retry Count	1
Final Action	Stop the cluster service and shutdown OS
Execute Script Before Reactivation	Off
Execute Script Before Failover	Off
Execute Script before Final Action	Off
Recovery Target	LocalServer
Recovery Target Type	Itself
Recovery Script Threshold	0
Reactivation Threshold	0
Failover Threshold	0
Wait Time to Start Monitoring (sec)	0
Nice Value	0
Monitor Suspend Possibility	Possible
Dummy Failure Possibility	Possible
Collect Dump at Timeout Occurrence	Off
Run Migration Before Run Failover	Off
Install Path	/home/ias/product/10.1.3.2/companionCDHome_1
Monitor Method	2
Component List	

Name:	OracleAS monitor resource name
Type:	Monitor resource type
Monitor Timing:	Timing to start monitoring
Target Resource:	Resource to be monitored
Interval (sec):	Interval between monitoring
Timeout (sec):	Timeout for monitoring (in seconds)
Do Not Retry at Timeout Occurrence:	Whether or not to retry when timeout occurs
Do Not Execute Recovery Action at Timeout Occurrence:	Whether or not to execute recovery action when timeout occurs
Retry Count:	The number of retries to be made from detection of an error in the monitor target to establish the error as an error
Final Action:	Final action at detection of an error
Execute Script before Reactivation:	Whether the pre-reactivation script is executed upon the detection of an error
Execute Script before Failover:	Whether the pre-failover script is executed upon the detection of an error
Execute Script before Final Action:	Whether the pre-final-action script is executed upon the detection of an error
Recovery Target:	Target to be recovered when an error is detected
Recovery Target Type:	Type of target to be recovered when an error is detected
Recovery Script Threshold:	The number of times the recovery script is executed upon the detection of an error
Reactivation Threshold:	The number of reactivations to be made at detection of an error
Failover Threshold:	The number of failovers to be made at detection of an error
Wait Time to Start Monitoring (sec):	Time to wait before starting monitoring (in seconds)
Nice Value:	Monitor resource nice value
Monitor Suspend Possibility:	Possibility of suspending monitoring
Dummy Failure Possibility:	Possibility of Dummy Failure

Collect Dump at Timeout Occurrence:	Whether or not dump of monitor process is collected when timeout occurs
Run Migration Before Run Failover:	Whether or not migration is run before running failover
Install Path:	Install path of OracleAS
Monitor Method:	The method for monitoring OracleAS
Component List:	The name of the target component

## **Understanding Oracle Clusterware Synchronization Management monitor resources**

It can't be used.

## Understanding POP3 monitor resources

POP3 monitor resources monitor POP3 services that run on the server. POP3 monitor resources monitor POP3 protocol but they are not intended for monitoring specific applications. POP3 monitor resources monitor various applications that use POP3 protocol.

### Note on POP3 monitor resources

For monitoring target resources, specify EXEC resources etc. that start POP3 services. Monitoring starts after target resource is activated. However, if POP3 services cannot be started immediately after target resource is activated, adjust the time using **Wait Time to Start Monitoring**.

To monitor a POP3 server that runs in the guest OS on a virtual machine controlled by a VM resource, specify the VM resource as the monitor target and specify enough wait time for the POP3 server to become accessible after the VM resource is activated for **Wait Time to Start Monitoring**.

POP3 services may produce operation logs for each monitoring. Configure the POP3 settings if this needs to be adjusted.

### Monitoring by POP3 monitor resources

POP3 monitor resources connect to the POP3 server and execute the command to verify the operation. As a result of monitoring, the following is considered as an error:

- (1) When connection to the POP3 server fails.
- (2) When an error is notified as a response to the command.

## Displaying and changing the POP3 monitor resource details

1. Click **Monitors** on the tree view displayed on the left side of the Builder window.
2. List of the monitor resources is displayed in the table view on the right side of the screen. Right-click the target POP3 monitor resource, and click the **Monitor(special)** tab in the **Monitor Resource Property** window.
3. On the **Monitor(special)** tab, you can display and/or change the detailed settings by following the description below.

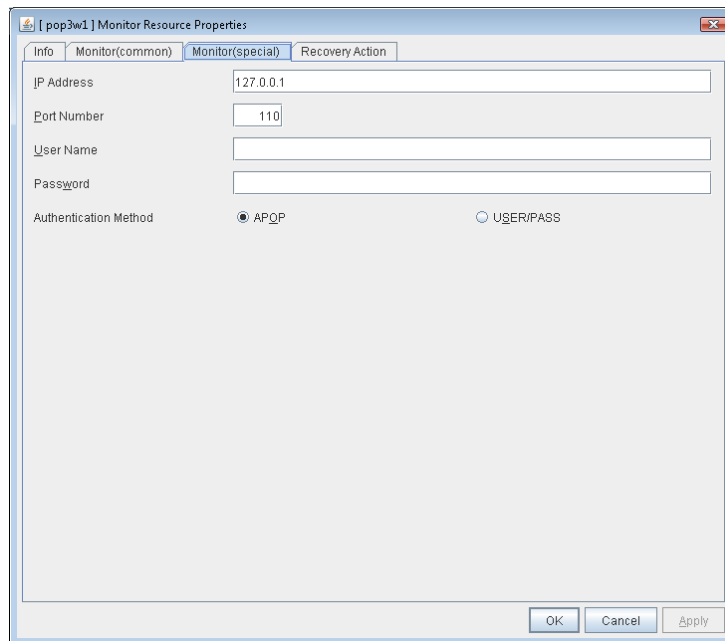

### IP Address (Within 79 bytes )

Specify the IP address of the POP3 server to be monitored. You must specify this IP address. If it is multi-directional standby server, specify FIP.

Usually, specify the loopback address (127.0.0.1) to connect to the POP3 server that runs on the local server. If the addresses for which connection is possible are limited by POP3 server settings, specify an address for which connection is possible (such as a floating IP address). To monitor a POP3 server that runs in the guest OS on a virtual machine controlled by a VM resource, specify the IP address of the virtual machine.

Default value: 127.0.0.1

### Port No. (1-65535)

Specify the POP3 port number to be monitored. You must specify this port number.

Default value: 110

### User Name (Within 255 bytes)

Specify the user name to log on to POP3.

Default value: None

**Password** (Within 255 bytes)

Specify the password to log on to POP3. Click **Change** and enter the password in the dialog box.

Default value: None

**Authentication Method**

Select the authentication method to log on to POP3. It must follow the settings of POP3 being used:

◆ APOP (Default value)

The encryption authentication method that uses the APOP command.

◆ USER/PASS

The plain text method that uses the USER/PASS command.



## Displaying the POP3 monitor resource properties with the WebManager

1. Start the WebManager.
2. Click the POP3 monitor resources object, , in the tree view. The following information is displayed in the list view.

POP3 Monitor Name: pop3w1		Details
Common server1 server2		
Properties	Value	
Comment		
IP Address	127.0.0.1	
Port	110	
Authority Method	APOP	
Status	Normal	
Resource Status on Each Server		
Server Name	Status	
server1	Normal	
server2	Normal	

Comment:	Comment of the POP3 monitor resource
IP Address:	IP address of the POP3 server to be monitored
Port No.:	Port number of the POP3 to be monitored
Authentication Method:	Authentication method to connect to POP3
Status:	Status of the POP3 monitor resource
Server Name:	Server name
Status:	Status of the monitor resource on the given server

When you click **Details**, the following information is displayed in the pop-up dialog box:

Properties	Value
Name	pop3w1
Type	pop3w
Monitor Timing	Activating
Target Resource	exec1
Interval (sec)	60
Timeout (sec)	120
Do Not Retry at Timeout Occurrence	Off
Do Not Execute Recovery Action at Timeout Occurrence	Off
Retry Count	3
Final Action	Stop the cluster service and shutdown OS
Execute Script Before Reactivation	Off
Execute Script Before Failover	Off
Execute Script before Final Action	Off
Recovery Target	LocalServer
Recovery Target Type	Itself
Recovery Script Threshold	0
Reactivation Threshold	0
Failover Threshold	0
Wait Time to Start Monitoring (sec)	0
Nice Value	0
Monitor Suspend Possibility	Possible
Dummy Failure Possibility	Possible
Collect Dump at Timeout Occurrence	Off
Run Migration Before Run Failover	Off

**Name:** POP3 monitor resource name  
**Type:** Monitor resource type  
**Monitor Timing:** Timing to start monitoring  
**Target Resource:** Resource to be monitored  
**Interval(sec):** Interval between monitoring (in seconds)  
**Timeout(sec):** Timeout for monitoring (in seconds)  
**Do Not Retry at Timeout Occurrence:** Whether or not to retry when timeout occurs  
**Do Not Execute Recovery Action at Timeout Occurrence:** Whether or not to execute recovery action when timeout occurs  
**Retry Count:** The number of retries to be made from detection of an error in the monitor target to establish the error as error  
**Final Action:** Final action at detection of an error  
**Execute Script before Reactivation:** Whether the pre-reactivation script is executed upon the detection of an error  
**Execute Script before Failover:** Whether the pre-failover script is executed upon the detection of an error  
**Execute Script before Final Action:** Whether the pre-final-action script is executed upon the detection of an error  
**Recovery Target:** Target to be recovered when an error is detected  
**Recovery Target Type:** Type of target to be recovered when an error is detected  
**Recovery Script Threshold:** The number of times the recovery script is executed upon the detection of an error  
**Reactivation Threshold:** The number of reactivations to be made at detection of an error  
**Failover Threshold:** The number of failovers to be made at detection of an error  
**Wait Time to Start Monitoring(sec):** Time to wait before starting of monitoring (in seconds)  
**Nice value:** Nice Value  
**Monitor Suspend Possibility:** Possibility of suspending monitoring  
**Dummy Failure Possibility:** Possibility of Dummy Failure  
**Collect Dump at Timeout Occurrence:** Whether or not dump of monitor process is collected when timeout occurs  
**Run Migration Before Run Failover:** Whether or not migration is run before running failover

## Understanding PostgreSQL monitor resources

PostgreSQL monitor resource monitors PostgreSQL database that operates on servers.

### Note on PostgreSQL monitor resources

For the supported versions of PostgreSQL, see “Software Applications supported by monitoring options” in Chapter 3, “Installation requirements for EXPRESSCLUSTER” in the *Getting Started Guide*.

This monitor resource uses the libpq library of PostgreSQL to monitor PostgreSQL.

If this monitor resource fails, set the application library path to the path where the libpq library of PostgreSQL exists.

To monitor a PostgreSQL database that runs in the guest OS on a virtual machine controlled by a VM resource, specify the VM resource as the monitor target and specify enough wait time for the PostgreSQL database to become accessible after the VM resource is activated for **Wait Time to Start Monitoring**.

If a value specified by a parameter differs from the PostgreSQL environment for monitoring, a message indicating an error is displayed on the alert view of the WebManager. Check the environment.

For client authentication, on this monitor resource, the following authentication methods that can be set to the “pg\_hba.conf” file has been checked its operation.  
trust, md5, password

When this monitor resource is used, messages like those shown below are output to a log on the PostgreSQL side. These messages are output by the monitor processing and do not indicate any problems.

```
YYYY-MM-DD hh:mm:ss JST moodle moodle LOG: statement: DROP TABLE psqlwatch
YYYY-MM-DD hh:mm:ss JST moodle moodle ERROR: table "psqlwatch" does not exist
YYYY-MM-DD hh:mm:ss JST moodle moodle STATEMENT: DROP TABLE psqlwatch
YYYY-MM-DD hh:mm:ss JST moodle moodle LOG: statement: CREATE TABLE
psqlwatch (num INTEGER NOT NULL PRIMARY KEY)
YYYY-MM-DD hh:mm:ss JST moodle moodle NOTICE: CREATE TABLE / PRIMARY
KEY will create implicit index "psqlwatch_pkey" for table "psql watch"
YYYY-MM-DD hh:mm:ss JST moodle moodle LOG: statement: DROP TABLE psqlwatch
```

If “Level 1” or “Level 2” is selected as a monitor level described in the next subsection “How PostgreSQL monitor resources perform monitoring”, monitor tables must be created manually beforehand.

A monitor error occurs if there is no monitor table at the start of monitoring in “Level 1”.

If there is no monitor table at the start of monitoring in “Level 2”, EXPRESSCLUSTER automatically creates the monitor table. In this case, a message indicating that the WebManager alert view does not have the monitor table is displayed.

The load on the monitor at “Level 3” is higher than that at “Level 1” and “Level 2” because the monitor in “Level 3” creates or deletes monitor tables for each monitoring.

Selectable monitor level	Prior creation of a monitor table
Level 1 (monitoring by select)	Required
Level 2 (monitoring by update/select)	Required
Level 3 (create/drop table each time)	Optional

Create a monitor table using either of the following methods:

**Use SQL statements (in the following example, the monitor table is named psqlwatch)**

```
sql> CREATE TABLE psqlwatch ( num INTEGER NOT NULL PRIMARY KEY);  
sql> INSERT INTO psqlwatch VALUES(0) ;  
sql> COMMIT;
```

**Use EXPRESSCLUSTER commands**

```
clp_psqlw --createtable -n <PostgreSQL_monitor_resource_name>  
To manually delete a monitor table, execute the following command:  
clp_psqlw --deletetable -n <PostgreSQL_monitor_resource_name>
```

## How PostgreSQL monitor resources perform monitoring

PostgreSQL monitor resources perform monitoring according to the specified monitor level.

◆ Level 1 (monitoring by select)

Monitoring with only reference to the monitor table. SQL statements executed for the monitor table are of (select) type.

An error is recognized if:

- (1) An error message is sent in response to a database connection or SQL statement message

◆ Level 2 (monitoring by update/select)

Monitoring with reference to and update of the monitoring table. One SQL statement can read/write numerical data of up to 11 digits. SQL statements executed for the monitor table are of (update/select/vacuum) type.

If a monitor table is automatically created at the start of monitoring, the SQL statement (create/insert) is executed for the monitor table.

An error is recognized if:

- (1) An error message is sent in response to a database connection or SQL statement message
- (2) The written data is not the same as the read data

◆ Level 3 (create/drop table each time)

Creation/deletion of the monitor table by statement as well as update. One SQL statement can read/write numerical data of up to 11 digits. SQL statements executed for the monitor table are of (create / insert / select / drop / vacuum) type.

An error is recognized if:

- (1) An error message is sent in response to a database connection or SQL statement message
- (2) The written data is not the same as the read data

## Displaying and changing the PostgreSQL monitor resource details

1. Click the **Monitors** icon on the tree view displayed on the left side of the Builder window.
2. List of the monitor resources is displayed in the table view on the right side of the screen. Right-click the target PostgreSQL monitor resource, and click the **Monitor(special)** tab in the **Monitor Resource Property** window.
3. On the **Monitor(special)** tab, you can see and/or change the detailed settings by following the description below.

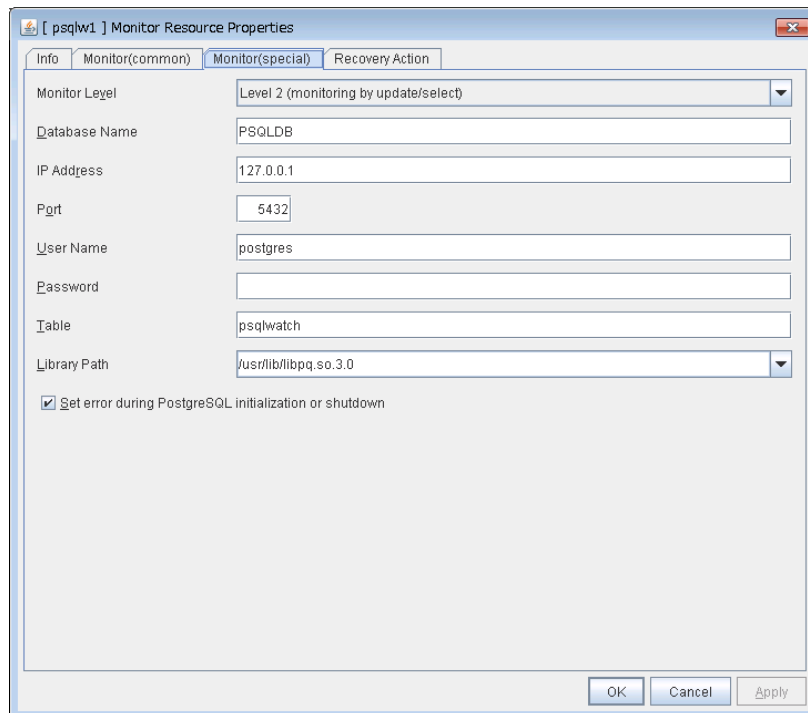

### Monitor Level

Select one of the following levels. You cannot omit this level setting.

- ◆ Level 1 (monitoring by select)
 

Monitoring with only reference to the monitor table. SQL statements executed for the monitor table are of (select) type.
- ◆ Level 2 (monitoring by update/select)
 

Monitoring with reference to and update of the monitoring table. SQL statements executed for the monitor table are of (update/select/vacuum) type.

If a monitor table is automatically created at the start of monitoring, the SQL statement (create/insert) is executed for the monitor table.
- ◆ Level 3 (create/drop table each time)
 

Creation/deletion of the monitor table by statement as well as update. SQL statements executed for the monitor table are of (create / insert / select / drop / vacuum) type.

Default: Level 2 (monitoring by update/select)

### Database Name (Within 255 bytes)

Specify the database name to be monitored. You must specify the name.

Default value: None

**IP Address** (Within 79 bytes)

Specify the IP address of the server to connect. You must specify the IP address.

Usually, specify the loopback address (127.0.0.1) to connect to the PostgreSQL server that runs on the local server. To monitor a PostgreSQL database that runs in the guest OS on a virtual machine controlled by a VM resource, specify the IP address of the virtual machine.

Default value: 127.0.0.1

**Port** (1 to 65535)

Specify the port number for connection. You must specify the number.

Default value: 5432

**User Name** (Within 255 bytes)

Specify the user name to log on to the database. You must specify the name.

Specify the PostgreSQL user who can access the specified database.

Default value: postgres

**Password** (Within 255 bytes)

Specify the password to log on to the database.

Default value: None

**Table** (Within 255 bytes)

Specify the name of a monitor table created in the database. You must specify the table name.

Make sure not to specify the same name as the table used for operation because a monitor table will be created and deleted. Be sure to set the name different from the reserved word in SQL statements.

Some characters cannot be used to specify a monitor table name according to the database specifications. For details, refer to the database specifications.

Default value: psqlwatch

**Library Path** (Within 1023 bytes)

Specify the home path to PostgreSQL. You must specify the path.

Default value: /usr/lib/libpq.so.3.0

**Set error during PostgreSQL initialization or shutdown**

When this function is enabled, a monitor error occurs immediately upon the detection of PostgreSQL start or shutdown in progress.

When this function is disabled, monitoring becomes normal even during PostgreSQL initialization or shutdown.

However, a monitor error occurs if PostgreSQL start or shutdown continues for one hour or more.

Default value: Enabled

## Displaying the PostgreSQL monitor resource properties with the WebManager

1. Start the WebManager.
2. When you click an object for a PostgreSQL monitor resource  in the tree view, the following information is displayed in the list view.

PostgreSQL Monitor Name: psqlw1		Details
Common server1 server2		
Properties	Value	
Comment		
Database Name	sample	
IP Address	127.0.0.1	
Port	5432	
Table	psqlwatch	
Status	Normal	
Resource Status on Each Server		
Server Name	Status	
server1	Normal	
server2	Offline	

Comment:	Comment on the PostgreSQL monitor resource
Database Name:	Monitor target database name
IP Address:	IP address for connecting to PostgreSQL server
Port:	Port number of PostgreSQL
Table:	Monitor table name created on a database
Status:	PostgreSQL monitor resource status
Server Name:	Server name
Status:	Status of the monitor resource on the server

When you click **Details**, the following information is displayed in the pop-up dialog box:

Properties	Value
Name	psqlw1
Type	psqlw
Monitor Timing	Activating
Target Resource	exec1
Interval (sec)	60
Timeout (sec)	120
Do Not Retry at Timeout Occurrence	Off
Do Not Execute Recovery Action at Timeout Occurrence	Off
Retry Count	2
Final Action	Stop the cluster service and shutdown OS
Execute Script Before Reactivation	Off
Execute Script Before Failover	Off
Execute Script before Final Action	Off
Recovery Target	failover1
Recovery Target Type	Group
Recovery Script Threshold	0
Reactivation Threshold	0
Failover Threshold	1
Wait Time to Start Monitoring (sec)	0
Nice Value	0
Monitor Suspend Possibility	Possible
Dummy Failure Possibility	Possible
Collect Dump at Timeout Occurrence	Off
Run Migration Before Run Failover	Off
Library Path	/usr/lib/libpq.so.3.0
Monitor Action	Level 2 (monitoring by update/select)

Name:	PostgreSQL monitor resource name
Type:	Monitor resource type
Monitor Timing:	Timing to start monitoring
Target Resource:	Resource to be monitored
Interval (sec):	Interval between monitoring (in seconds)
Timeout (sec):	Timeout for monitoring (in seconds)
Do Not Retry at Timeout Occurrence:	Whether or not to retry when timeout occurs
Do Not Execute Recovery Action at Timeout Occurrence:	Whether or not to execute recovery action when timeout occurs
Retry Count:	The number of retries to be made from detection of an error in the monitor target to establish the error as an error
Final Action:	Final action at detection of an error
Execute Script before Reactivation:	Whether the pre-reactivation script is executed upon the detection of an error
Execute Script before Failover:	Whether the pre-failover script is executed upon the detection of an error
Execute Script before Final Action:	Whether the pre-final-action script is executed upon the detection of an error
Recovery Target:	Target to be recovered when an error is detected
Recovery Target Type:	Type of target to be recovered when an error is detected
Recovery Script Threshold:	The number of times the recovery script is executed upon the detection of an error
Reactivation Threshold:	The number of reactivations to be made at detection of an error
Failover Threshold:	The number of failovers to be made at detection of an error
Wait Time to Start Monitoring (sec):	Time to wait before starting monitoring (in seconds)
Nice Value:	Monitor resource nice value
Monitor Suspend Possibility:	Possibility of suspending monitoring
Dummy Failure Possibility:	Possibility of Dummy Failure



Collect Dump at Timeout Occurrence: Whether or not dump of monitor process is collected when timeout occurs  
Run Migration Before Run Failover: Whether or not migration is run before running failover  
Library Path: Library path of PostgreSQL  
Monitor Action: Monitor level

## Understanding Samba monitor resources

Samba monitor resource monitors samba file server that operates on servers.

### Note on Samba monitor resources

For the supported versions of samba, see “Software Applications supported by monitoring options” in Chapter 3, “Installation requirements for EXPRESSCLUSTER” in the *Getting Started Guide*.

If this monitor resource fails, the parameter value and samba environment may not match. Check the samba environment

Specify the smb.conf file for the shared name to be monitored to enable a connection from a local server. Allow guest connection when the security parameter of the smb.conf file is “share.”

Samba functions except file sharing and print sharing

To monitor a samba file server that runs in the guest OS on a virtual machine controlled by a VM resource, specify the VM resource as the monitor target and specify enough wait time for the samba file server to become accessible after the VM resource is activated for **Wait Time to Start Monitoring**.

If the smbmount command is run on the monitoring server when the samba authentication mode is “Domain” or “Server,” it may be mounted as a user name specified by the parameter of this monitor resource.

### How Samba monitor resources perform monitoring

Samba monitor resource monitors the following:

By connecting to samba server and verify establishment of tree connection to resources of the samba server.

This monitor resource determines the following results as an error:

- (1) A response to samba service request is invalid.

## Displaying and changing the Samba monitor resource details

1. Click the **Monitors** icon on the tree view displayed on the left side of the Builder window.
2. List of the monitor resources is displayed in the table view on the right side of the screen. Right-click the target samba monitor resource, and click the **Monitor(special)** tab in the **Monitor Resource Property** window.
3. On the **Monitor(special)** tab, you can see and/or change the detailed settings by following the description below.

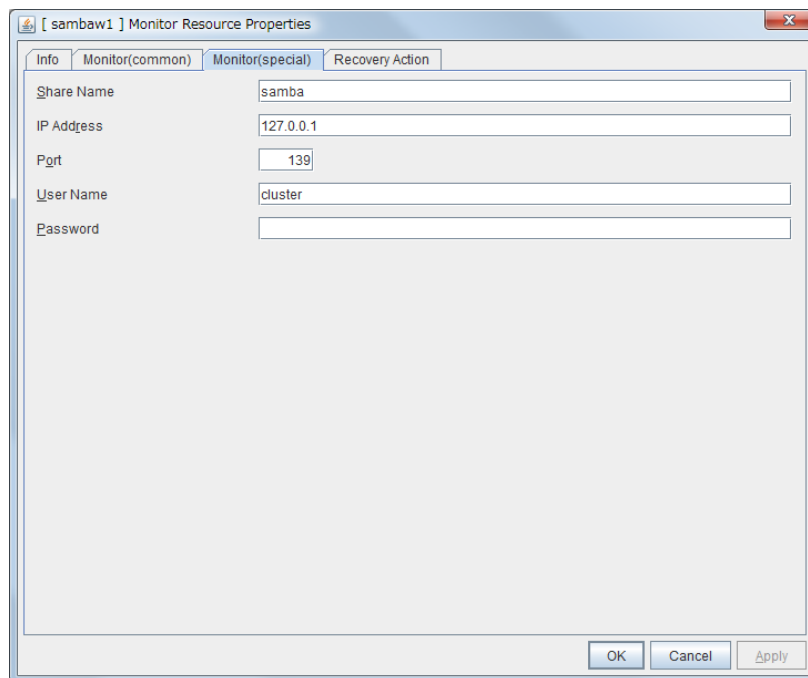

### **Share Name** (Within 255 bytes)

Specify the shared name of samba server to be monitored. You must specify the name.

Default value: None

### **IP Address** (Within 79 bytes)

Specify the IP address of samba server. You must specify the IP address.

Usually, specify the loopback address (127.0.0.1) to connect to the samba file server that runs on the local server. To monitor a samba file server that runs in the guest OS on a virtual machine controlled by a VM resource, specify the IP address of the virtual machine.

Default value: 127.0.0.1

### **Port** 1 to 65535

Specify the port number to be used by samba daemon. You must specify the port number.

Default value: 139

**User Name** (Within 255 bytes)

Specify the user name to log on to the samba service. You must specify the user name.

Default value: None

**Password** (Within 255 bytes)

Specify the password to log on to the samba service.

Default value: None

## Displaying the Samba monitor resource properties with the WebManager

1. Start the WebManager.
2. When you click an object for a Samba monitor resource  in the tree view, the following information is displayed in the list view.

Samba Monitor Name: sambaw1		Details
<span>Common</span> <span>server1</span> <span>server2</span>		
Properties	Value	
Comment		
Share Name	samba	
IP Address	127.0.0.1	
Port	139	
Status	Normal	
Resource Status on Each Server		
Server Name	Status	
server1	Normal	
server2	Offline	

Comment:

Share Name:

IP Address:

Port:

Status:

Server Name:

Status:

Comment on the Samba monitor resource

Share name of the monitor target samba server

IP address for connecting to samba server

Port number of the samba server

Samba monitor resource status

Server name

Status of the monitor resource on the server

When you click **Details**, the following information is displayed in the pop-up dialog box:

Properties	Value
Name	sambaw1
Type	sambaw
Monitor Timing	Activating
Target Resource	exec1
Interval (sec)	30
Timeout (sec)	60
Do Not Retry at Timeout Occurrence	Off
Do Not Execute Recovery Action at Timeout Occurrence	Off
Retry Count	5
Final Action	Stop the cluster service and shutdown OS
Execute Script Before Reactivation	Off
Execute Script Before Failover	Off
Execute Script before Final Action	Off
Recovery Target	LocalServer
Recovery Target Type	Itself
Recovery Script Threshold	0
Reactivation Threshold	0
Failover Threshold	0
Wait Time to Start Monitoring (sec)	0
Nice Value	0
Monitor Suspend Possibility	Possible
Dummy Failure Possibility	Possible
Collect Dump at Timeout Occurrence	Off
Run Migration Before Run Failover	Off

- Name: Samba monitor resource name
- Type: Monitor resource type
- Monitor Timing: Timing to start monitoring
- Target Resource: Resource to be monitored
- Interval (sec): Interval between monitoring (in seconds)
- Timeout (sec): Timeout for monitoring (in seconds)
- Do Not Retry at Timeout Occurrence: Whether or not to retry when timeout occurs
- Do Not Execute Recovery Action at Timeout Occurrence: Whether or not to execute recovery action when timeout occurs
- Retry Count: The number of retries to be made from detection of an error in the monitor target to establish the error as an error
- Final Action: Final action at detection of an error
- Execute Script before Reactivation: Whether the pre-reactivation script is executed upon the detection of an error
- Execute Script before Failover: Whether the pre-failover script is executed upon the detection of an error
- Execute Script before Final Action: Whether the pre-final-action script is executed upon the detection of an error
- Recovery Target: Target to be recovered when an error is detected
- Recovery Target Type: Type of target to be recovered when an error is detected
- Recovery Script Threshold: The number of times the recovery script is executed upon the detection of an error
- Reactivation Threshold: The number of reactivations to be made at detection of an error
- Failover Threshold: The number of failovers to be made at detection of an error
- Wait Time to Start Monitoring (sec): Time to wait before starting monitoring (in seconds)
- Nice Value: Monitor resource nice value
- Dummy Failure Possibility: Possibility of Dummy Failure
- Collect Dump at Timeout Occurrence: Whether or not dump of monitor process is collected when timeout occurs
- Run Migration Before Run Failover: Whether or not migration is run before running failover

## Understanding SMTP monitor resources

SMTP monitor resource monitors SMTP daemon that operates on servers.

### Note on SMTP monitor resources

For the supported versions of SMTP, see “Software Applications supported by monitoring options” in Chapter 3, “Installation requirements for EXPRESSCLUSTER” in the *Getting Started Guide*.

If a state that the load average exceeds the RefuseLA value set in the sendmail.def file for a certain period of time, the monitoring commands may consider this as an error and perform failover.

To monitor an SMTP server that runs in the guest OS on a virtual machine controlled by a VM resource, specify the VM resource as the monitor target and specify enough wait time for the SMTP server to become accessible after the VM resource is activated for **Wait Time to Start Monitoring**.

### How SMTP monitor resources perform monitoring

SMTP monitor resource monitors the following:

Monitors the SMTP daemon by connecting to the SMTP daemon on the server and issuing the NOOP command

This monitor resource determines the following result as an error:

- (1) An error reporting as the response to the SMTP daemon or issued NOOP command.

## Displaying and changing the SMTP monitor resource details

1. Click the **Monitors** icon on the tree view displayed on the left side of the Builder window.
2. List of the monitor resources is displayed in the table view on the right side of the screen. Right-click the target SMTP monitor resource, and click the **Monitor(special)** tab in the **Monitor Resource Property** window.
3. On the **Monitor(special)** tab, you can see and/or change the detailed settings by following the description below.

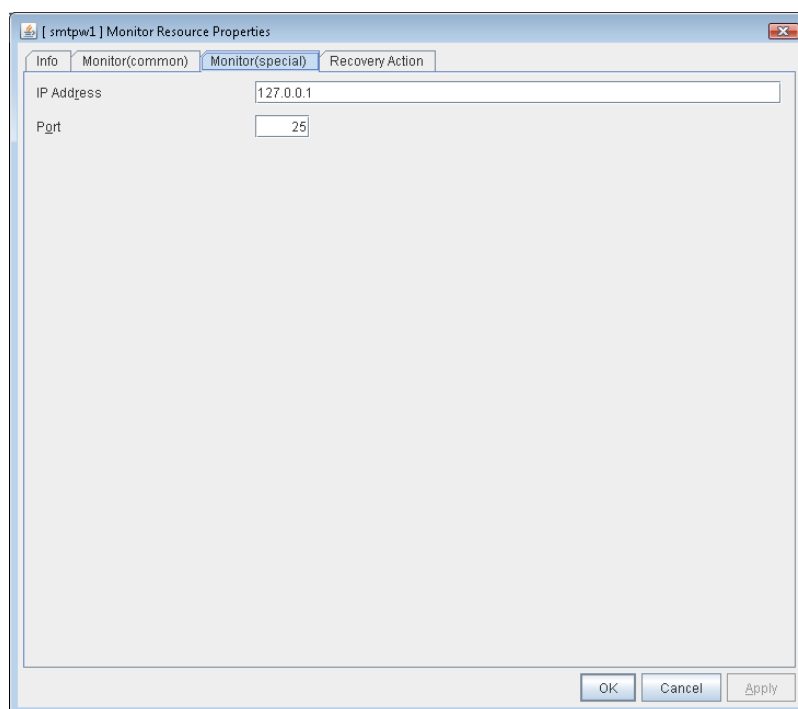

### **IP Address** (Within 79 bytes)

Specify the IP address of the SMTP server to be monitored. You must specify the IP address.

Usually, specify the loopback address (127.0.0.1) to connect to the SMTP server that runs on the local server. To monitor an SMTP server that runs in the guest OS on a virtual machine controlled by a VM resource, specify the IP address of the virtual machine.

Default value: 127.0.0.1

### **Port** (1 to 65535)

Specify the port number used to connect to the SMTP server. You must specify the port number.

Default value: 25



## Displaying the SMTP monitor resource properties with the WebManager

1. Start the WebManager.
2. When you click an object for a SMTP monitor resource  in the tree view, the following information is displayed in the list view.

SMTP Monitor Name: smtpw1		Details
Common		server1
server2		
Properties	Value	
Comment		
IP Address	127.0.0.1	
Port	25	
Status	Normal	
Resource Status on Each Server		
Server Name	Status	
server1	Normal	
server2	Normal	

Comment:

IP Address:

Port:

Status:

Server Name:

Status:

Comment on the SMTP monitor resource

IP address for connecting to SMTP server

Port number of the SMTP server

SMTP monitor resource status

Server name

Status of the monitor resource on the server

When you click **Details**, the following information is displayed in the pop-up dialog box:

Properties	Value
Name	smtpw1
Type	smtpw
Monitor Timing	Activating
Target Resource	exec1
Interval (sec)	60
Timeout (sec)	120
Do Not Retry at Timeout Occurrence	Off
Do Not Execute Recovery Action at Timeout Occurrence	Off
Retry Count	3
Final Action	Stop the cluster service and shutdown OS
Execute Script Before Reactivation	Off
Execute Script Before Failover	Off
Execute Script before Final Action	Off
Recovery Target	LocalServer
Recovery Target Type	Itself
Recovery Script Threshold	0
Reactivation Threshold	0
Failover Threshold	0
Wait Time to Start Monitoring (sec)	0
Nice Value	0
Monitor Suspend Possibility	Possible
Dummy Failure Possibility	Possible
Collect Dump at Timeout Occurrence	Off
Run Migration Before Run Failover	Off

**Name:** SMTP monitor resource name  
**Type:** Monitor resource type  
**Monitor Timing:** Timing to start monitoring  
**Target Resource:** Resource to be monitored  
**Interval (sec):** Interval between monitoring (in seconds)  
**Timeout (sec):** Timeout for monitoring (in seconds)  
**Do Not Retry at Timeout Occurrence:** Whether or not to retry when timeout occurs  
**Do Not Execute Recovery Action at Timeout Occurrence:** Whether or not to execute recovery action when timeout occurs  
**Retry Count:** The number of retries to be made from detection of an error in the monitor target to establish the error as an error  
**Final Action:** Final action at detection of an error  
**Execute Script before Reactivation:** Whether the pre-reactivation script is executed upon the detection of an error  
**Execute Script before Failover:** Whether the pre-failover script is executed upon the detection of an error  
**Execute Script before Final Action:** Whether the pre-final-action script is executed upon the detection of an error  
**Recovery Target:** Target to be recovered when an error is detected  
**Recovery Target Type:** Type of target to be recovered when an error is detected  
**Recovery Script Threshold:** The number of times the recovery script is executed upon the detection of an error  
**Reactivation Threshold:** The number of reactivations to be made at detection of an error  
**Failover Threshold:** The number of failovers to be made at detection of an error  
**Wait Time to Start Monitoring (sec):** Time to wait before starting monitoring (in seconds)  
**Nice Value:** Monitor resource nice value  
**Monitor Suspend Possibility:** Possibility of suspending monitoring  
**Dummy Failure Possibility:** Possibility of Dummy Failure  
**Collect Dump at Timeout Occurrence:** Whether or not dump of monitor process is collected when timeout occurs

Run Migration Before Run Failover: Whether or not migration is run before running failover

## Understanding Sybase monitor resources

Sybase monitor resource monitors Sybase database that operates on servers.

### Note on Sybase monitor resources

For the supported versions of Sybase, see “Software Applications supported by monitoring options” in Chapter 3, “Installation requirements for EXPRESSCLUSTER” in the *Getting Started Guide*.

This monitor resource monitors ASE using Open Client DB-Library/C of ASE.

If a value specified by a parameter differs from the ASE environment for monitoring, an error message is displayed on the WebManager alert view. Check the environment.

If “Level 1” or “Level 2” is selected as a monitor level described in the next subsection “How Sybase monitor resources perform monitoring”, monitor tables must be created manually beforehand.

A monitor error occurs if there is no monitor table at the start of monitoring in “Level 1”.

If there is no monitor table at the start of monitoring in “Level 2”, EXPRESSCLUSTER automatically creates the monitor table. In this case, a message indicating that the WebManager alert view does not have the monitor table is displayed.

The load on the monitor at “Level 3” is higher than that at “Level 1” and “Level 2” because the monitor in “Level 3” creates or deletes monitor tables for each monitoring.

Selectable monitor level	Prior creation of a monitor table
Level 0 (database status)	Optional
Level 1 (monitoring by select)	Required
Level 2 (monitoring by update/select)	Required
Level 3 (create/drop table each time)	Optional

Create a monitor table using either of the following methods:

Alphanumeric characters and some symbols (such as underscores) can be used to specify a monitor table name.

**Use SQL statements (in the following example, the monitor table is named sybwatch)**

```
sql> CREATE TABLE sybwatch (num INT NOT NULL PRIMARY KEY)
sql> GO
sql> INSERT INTO sybwatch VALUES(0)
sql> GO
sql> COMMIT
sql> GO
```

**Use EXPRESSCLUSTER commands**

```
clp_sybasew --createtable -n <Sybase_monitor_resource_name>
```

To manually delete a monitor table, execute the following command:

```
clp_sybasew --deletetable -n <Sybase_monitor_resource_name>
```

## How Sybase monitor resources perform monitoring

Sybase monitor resources perform monitoring according to the specified monitor level.

- ◆ Level 0 (database status)

The Sybase management table (`sys.sysdatabases`) is referenced to check the DB status. This level corresponds to simplified monitoring without SQL statements being issued for the monitor table.

An error is recognized if:

- (1) The database status is in an unusable state, e.g., offline.

- ◆ Level 1 (monitoring by select)

Monitoring with only reference to the monitor table. SQL statements executed for the monitor table are of (select) type.

An error is recognized if:

- (1) An error message is sent in response to a database connection or SQL statement message

- ◆ Level 2 (monitoring by update/select)

Monitoring with reference to and update of the monitoring table. One SQL statement can read/write numerical data of up to 11 digits. SQL statements executed for the monitor table are of (update/select) type.

If a monitor table is automatically created at the start of monitoring, the SQL statement (create/insert) is executed for the monitor table.

An error is recognized if:

- (1) An error message is sent in response to a database connection or SQL statement message
- (2) The written data is not the same as the read data

- ◆ Level 3 (create/drop table each time)

Creation/deletion of the monitor table by statement as well as update. One SQL statement can read/write numerical data of up to 11 digits. SQL statements executed for the monitor table are of (create / insert / select / drop) type.

An error is recognized if:

- (1) An error message is sent in response to a database connection or SQL statement message
- (2) The written data is not the same as the read data

## Displaying and changing the Sybase monitor resource details

1. Click the **Monitors** icon on the tree view displayed on the left side of the Builder window.
2. List of the monitor resources is displayed in the table view on the right side of the screen. Right-click the target Sybase monitor resource, and click the **Monitor(special)** tab in the **Monitor Resource Property** window.
3. On the **Monitor(special)** tab, you can see and/or change the detailed settings by following the description below.

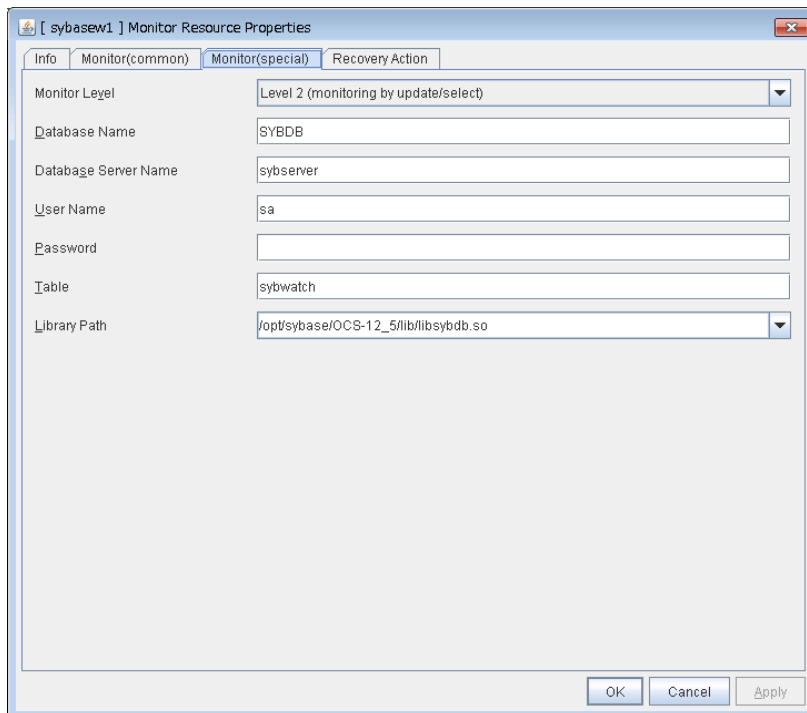

### Monitor Level

Select one of the following levels. You cannot omit this level setting.

- ◆ Level 0 (database status)
 

The Sybase management table (sys.sysdatabases) is referenced to check the DB status. This level corresponds to simplified monitoring without SQL statements being issued for the monitor table.
- ◆ Level 1 (monitoring by select)
 

Monitoring with only reference to the monitor table. SQL statements executed for the monitor table are of (select) type.
- ◆ Level 2 (monitoring by update/select)
 

Monitoring with reference to and update of the monitoring table. SQL statements executed for the monitor table are of (update/select) type.

If a monitor table is automatically created at the start of monitoring, the SQL statement (create/insert) is executed for the monitor table.
- ◆ Level 3 (create/drop table each time)
 

Creation/deletion of the monitor table by statement as well as update. SQL statements executed for the monitor table are of (create / insert / select / drop) type.

Default: Level 2 (monitoring by update/select)

**Database Name** (Within 255 bytes)

Specify the database to be monitored. You must specify the database.

Default value: None

**Database Server Name** (Within 255 bytes)

Specify the database server name to be monitored. You must specify the database server.

Default value: None

**User Name** (Within 255 bytes)

Specify the user name to log on to the database. You must specify the user name.

Specify the Sybase user who can access the specified database.

Default value: sa

**Password** (Within 255 bytes)

Specify the password to log on to the database.

Default value: None

**Table** (Within 255 bytes)

Specify the name of a monitor table created in the database. You must specify the name.

Make sure not to specify the same name as the table used for operation because a monitor table will be created and deleted. Make sure to set the name different from the reserved word in SQL statements.

Some characters cannot be used to specify a monitor table name according to the database specifications. For details, refer to the database.

Default value: sybwatch

**Library Path** (Within 1023 bytes)

Specify the home path to Sybase. You must specify the path.

Default value: /opt/sybase/OCS-12\_5/lib/libsybdb.so

## Displaying the Sybase monitor resource properties with the WebManager

1. Start the WebManager.
2. When you click an object for a Sybase monitor resource  in the tree view, the following information is displayed in the list view.

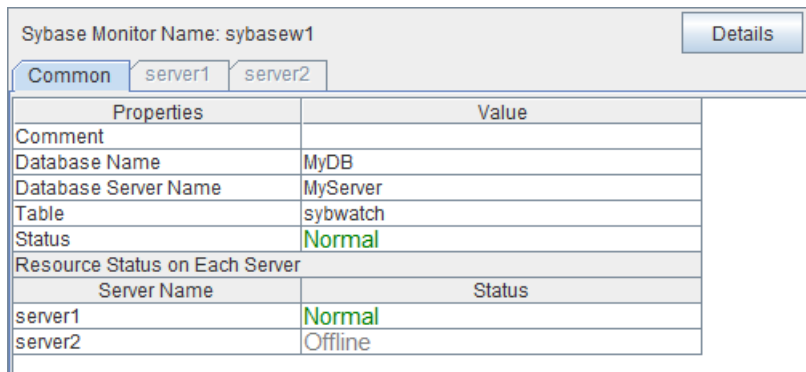

Properties		Value
Comment		
Database Name		MyDB
Database Server Name		MyServer
Table		sybwatch
Status		Normal
Resource Status on Each Server		
Server Name		Status
server1		Normal
server2		Offline

Comment:	Comment on the Sybase monitor resource
Database Name:	Monitor target database name
Database Server Name:	Monitor target database server name
Table:	Monitor table name created on a database
Status:	Sybase monitor resource status
Server Name:	Server name
Status:	Status of the monitor resource on the server



When you click **Details**, the following information is displayed in the pop-up dialog box:

Properties	Value
Name	sybasew1
Type	sybasew
Monitor Timing	Activating
Target Resource	exec1
Interval (sec)	60
Timeout (sec)	120
Do Not Retry at Timeout Occurrence	Off
Do Not Execute Recovery Action at Timeout Occurrence	Off
Retry Count	2
Final Action	Stop the cluster service and shutdown OS
Execute Script Before Reactivation	Off
Execute Script Before Failover	Off
Execute Script before Final Action	Off
Recovery Target	failover1
Recovery Target Type	Group
Recovery Script Threshold	0
Reactivation Threshold	0
Failover Threshold	1
Wait Time to Start Monitoring (sec)	0
Nice Value	0
Monitor Suspend Possibility	Possible
Dummy Failure Possibility	Possible
Collect Dump at Timeout Occurrence	Off
Run Migration Before Run Failover	Off
Library Path	/opt/sybase/OCS-12_5/lib/libsybdb.so
Monitor Action	Level 2 (monitoring by update/select)

- Name: Sybase monitor resource name
- Type: Monitor resource type
- Monitor Timing: Timing to start monitoring
- Target Resource: Resource to be monitored
- Interval (sec): Interval between monitoring (in seconds)
- Timeout (sec): Timeout for monitoring (in seconds)
- Do Not Retry at Timeout Occurrence: Whether or not to retry when timeout occurs
- Do Not Execute Recovery Action at Timeout Occurrence: Whether or not to execute recovery action when timeout occurs
- Retry Count: The number of retries to be made from detection of an error in the monitor target to establish the error as an error
- Final Action: Final action at detection of an error
- Execute Script before Reactivation: Whether the pre-reactivation script is executed upon the detection of an error
- Execute Script before Failover: Whether the pre-failover script is executed upon the detection of an error
- Execute Script before Final Action: Whether the pre-final-action script is executed upon the detection of an error
- Recovery Target: Target to be recovered when an error is detected
- Recovery Target Type: Type of target to be recovered when an error is detected
- Recovery Script Threshold: The number of times the recovery script is executed upon the detection of an error
- Reactivation Threshold: The number of reactivations to be made at detection of an error
- Failover Threshold: The number of failovers to be made at detection of an error
- Wait Time to Start Monitoring (sec): Time to wait before starting monitoring (in seconds)
- Nice Value: Monitor resource nice value
- Monitor Suspend Possibility: Possibility of suspending monitoring
- Dummy Failure Possibility: Possibility of Dummy Failure

Collect Dump at Timeout Occurrence:	Whether or not dump of monitor process is collected when timeout occurs
Run Migration Before Run Failover:	Whether or not migration is run before running failover
Library Path:	Library path of Sybase
Monitor Action:	Monitor level

## Understanding Tuxedo monitor resources

Tuxedo monitor resource monitors Tuxedo that operates on servers.

### Note on Tuxedo monitor resources

For the supported versions of Tuxedo, see “Software Applications supported by monitoring options” in Chapter 3, “Installation requirements for EXPRESSCLUSTER” in the *Getting Started Guide*.

If any library of the Tuxedo such as libtux.so does not exist, monitoring cannot be performed.

### How Tuxedo monitor resources perform monitoring

Tuxedo monitor resource monitors the following:

This monitor resource executes the application server monitoring by using the API of the Tuxedo. The command determines the following results as an error:

- (1) An error is reported in response to ping.

## Displaying and changing the Tuxedo monitor resource details

1. Click the **Monitors** icon on the tree view displayed on the left side of the Builder window.
2. List of the monitor resources is displayed in the table view on the right side of the screen. Right-click the target Tuxedo monitor resource, and click the **Monitor(special)** tab in the **Monitor Resource Property** window.
3. On the **Monitor(special)** tab, you can see and/or change the detailed settings by following the description below.

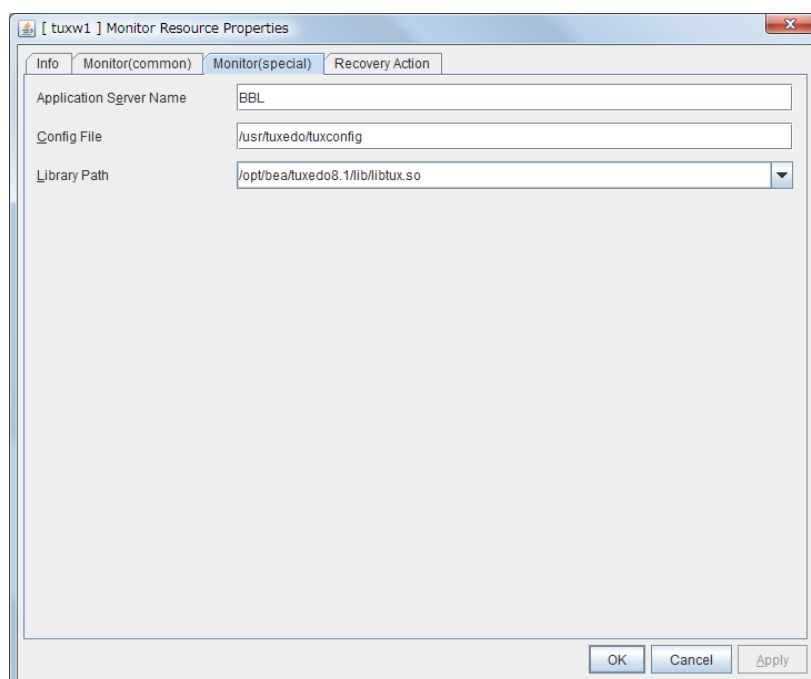

**Application Server Name** (Within 255 bytes)

Specify the IP address of the server to be monitored. You must specify the name.

Default value: BBL

**Config File** (Within 1023 bytes)

Specify the placement file name of Tuxedo. You must specify the name.

Default value: None

**Library Path** (Within 1023 bytes)

Specify the library path of Tuxedo. You must specify the path.

Default value: /opt/bea/tuxedo8.1/lib/libtux.so

## Displaying the Tuxedo monitor resource properties with the WebManager

1. Start the WebManager.
2. When you click an object for a Tuxedo monitor resource  in the tree view, the following information is displayed in the list view.

Tuxedo Monitor Name: tuxw1		Details	
Common		server1	server2
Properties	Value		
Comment			
Application Server Name	BBL		
Status	Normal		
Resource Status on Each Server			
Server Name	Status		
server1	Normal		
server2	Offline		

Comment: Comment on the Tuxedo monitor resource  
 Application Server Name: Monitor target application server name  
 Status: Tuxedo monitor resource status

Server Name: Server name  
 Status: Status of the monitor resource on the server

When you click **Details**, the following information is displayed in the pop-up dialog box:

Properties	Value
Name	tuxw1
Type	tuxw
Monitor Timing	Activating
Target Resource	exec1
Interval (sec)	60
Timeout (sec)	120
Do Not Retry at Timeout Occurrence	Off
Do Not Execute Recovery Action at Timeout Occurrence	Off
Retry Count	2
Final Action	Stop the cluster service and shutdown OS
Execute Script Before Reactivation	Off
Execute Script Before Failover	Off
Execute Script before Final Action	Off
Recovery Target	LocalServer
Recovery Target Type	Itself
Recovery Script Threshold	0
Reactivation Threshold	0
Failover Threshold	0
Wait Time to Start Monitoring (sec)	0
Nice Value	0
Monitor Suspend Possibility	Possible
Dummy Failure Possibility	Possible
Collect Dump at Timeout Occurrence	Off
Run Migration Before Run Failover	Off
Config File	/etc/conf
Library Path	/opt/beanuxedo8.1/lib/libtux.so

Name:	Tuxedo monitor resource name
Type:	Monitor resource type
Monitor Timing:	Timing to start monitoring
Target Resource:	Resource to be monitored
Interval (sec):	Interval between monitoring (in seconds)
Timeout (sec):	Timeout for monitoring (in seconds)
Do Not Retry at Timeout Occurrence:	Whether or not to retry when timeout occurs
Do Not Execute Recovery Action at Timeout Occurrence:	Whether or not to execute recovery action when timeout occurs
Retry Count:	The number of retries to be made from detection of an error in the monitor target to establish the error as an error
Final Action:	Final action at detection of an error
Execute Script before Reactivation:	Whether the pre-reactivation script is executed upon the detection of an error
Execute Script before Failover:	Whether the pre-failover script is executed upon the detection of an error
Execute Script before Final Action:	Whether the pre-final-action script is executed upon the detection of an error
Recovery Target:	Target to be recovered when an error is detected
Recovery Target Type:	Type of target to be recovered when an error is detected
Recovery Script Threshold:	The number of times the recovery script is executed upon the detection of an error
Reactivation Threshold:	The number of reactivations to be made at detection of an error
Failover Threshold:	The number of failovers to be made at detection of an error
Wait Time to Start Monitoring (sec):	Time to wait before starting monitoring (in seconds)
Nice Value:	Monitor resource nice value
Monitor Suspend Possibility:	Possibility of suspending monitoring
Dummy Failure Possibility:	Possibility of Dummy Failure

Collect Dump at Timeout Occurrence:	Whether or not dump of monitor process is collected when timeout occurs
Run Migration Before Run Failover:	Whether or not migration is run before running failover
Config File:	Configuration file path of Tuxedo
Library Path:	Library path of Tuxedo

## Understanding Weblogic monitor resources

Weblogic monitor resource monitors Weblogic that operates on servers.

### Note on Weblogic monitor resources

For the supported versions of Weblogic, see “Software Applications supported by monitoring options” in Chapter 3, “Installation requirements for EXPRESSCLUSTER” in the *Getting Started Guide*.

A Java environment is required to start monitoring with this monitor resource. The application server system uses Java functions. Therefore if Java stalls, it may be recognized as an error.

If Weblogic monitor resources are not available at the startup of WebLogic, they will be judged as being abnormal. Adjust [Wait Time to Start Monitoring], or start WebLogic before the startup of the Weblogic monitor resources (for example, specify the script resource for starting Weblogic as a monitor target resource)

### How Weblogic monitor resources perform monitoring

Weblogic monitor resource monitors the following:

Monitors the application server by performing connect with the “webLogic.WLST” command.

This monitor resource determines the following results as an error:

- (1) An error reporting as the response to the `connect`.



## Displaying and changing the Weblogic monitor resource details

1. Click the **Monitors** icon on the tree view displayed on the left side of the Builder window.
2. List of the monitor resources is displayed in the table view on the right side of the screen. Right-click the target Weblogic monitor resource, and click the **Monitor(special)** tab in the **Monitor Resource Property** window.
3. On the **Monitor(special)** tab, you can see and/or change the detailed settings by following the description below.

The screenshot shows the 'Monitor Resource Properties' dialog box with the 'Monitor(special)' tab selected. The fields are as follows:

- IP Address:** 127.0.0.1
- Port:** 7002
- Account Shadow:** Radio buttons for 'On' and 'Off'. 'Off' is selected. Below are fields for 'Config File', 'Key File', 'User Name' (weblogic), and 'Password' (weblogic).
- Authority Method:** A dropdown menu showing 'DemoTrust'. Below is a field for 'Key Store File'.
- Domain Environment File:** A dropdown menu showing '/opt/bee/weblogic81/samples/domains/examples/setExamplesEnv.sh'.
- Add command option:** A text field containing '-Dwlst.offline.log=disable -Duser.language=en\_US'.

Buttons at the bottom: OK, Cancel, Apply.

### IP Address (Within 79 bytes)

Specify the IP address of the server to be monitored. You must specify the IP address.

Default value: 127.0.0.1

### Port (1 to 65535)

Specify the port number used to connect to the server. You must specify the number.

Default value: 7002

### Account Shadow

When you specify a user name and a password directly, select **Off**. If not, select **On**. You must specify the setting.

Default value: Off

### Config File (Within 1023 bytes)

Specify the file in which the user information is saved. You must specify the file if **Account Shadow** is **On**.

Default value: None

**Key File** (Within 1023 bytes)

Specify the file in which the password required to access to a config file path is saved. Specify the full path of the file. You must specify the file if **Account Shadow** is **On**.

Default value: None

**User Name** (Within 255 bytes)

Specify the user name of Weblogic. You must specify the file if **Account Shadow** is **Off**.

Default value: weblogic

**Password** (Within 255 bytes)

Specify the password of Weblogic.

Default value: weblogic

**Authority Method**

Specify the authentication method when connecting to an application server. You must specify the method.

Default value: DemoTrust

**Key Store File** (Within 1023 bytes)

Specify the authentication file when authenticating SSL. You must specify this when the authentication method is **CustomTrust**.

Default value: None

**Domain Environment File** (Within 1023 bytes)

Specify the domain environment file mane of Weblogic. You must specify the file name.

Default value: /opt/bea/weblogic81/samples/domains/examples/setExamplesEnv.sh

**Add Command Option (up to 1023 bytes)**

Specify the additional command option when changing the option to be passed to the [webLogic.WLST] command.

Default value: -Dwlst.offline.log=disable -Duser.language=en\_US

## Displaying the Weblogic monitor resource properties with the WebManager

1. Start the WebManager.
2. When you click an object for a Weblogic monitor resource  in the tree view, the following information is displayed in the list view.

Weblogic Monitor Name: wls1		Details
<div style="display: flex; justify-content: space-between;"> <span>Common</span> <span>server1</span> <span>server2</span> </div>		
Properties	Value	
Comment		
IP Address	127.0.0.1	
Port	7002	
Status	Normal	
Resource Status on Each Server		
Server Name	Status	
server1	Normal	
server2	Offline	

Comment:	Comment on the Weblogic monitor resource
IP Address:	IP address for connecting to an application server
Port:	Port number of Weblogic
Status:	Weblogic monitor resource status
Server Name:	Server name
Status:	Status of the monitor resource on the server

When you click **Details**, the following information is displayed in the pop-up dialog box:

Properties	Value
Name	wlsw1
Type	wlsw
Monitor Timing	Activating
Target Resource	exec1
Interval (sec)	60
Timeout (sec)	120
Do Not Retry at Timeout Occurrence	Off
Do Not Execute Recovery Action at Timeout Occurrence	Off
Retry Count	2
Final Action	Stop the cluster service and shutdown OS
Execute Script Before Reactivation	Off
Execute Script Before Failover	Off
Execute Script before Final Action	Off
Recovery Target	LocalServer
Recovery Target Type	Itself
Recovery Script Threshold	0
Reactivation Threshold	0
Failover Threshold	0
Wait Time to Start Monitoring (sec)	0
Nice Value	0
Monitor Suspend Possibility	Possible
Dummy Failure Possibility	Possible
Collect Dump at Timeout Occurrence	Off
Run Migration Before Run Failover	Off
Authority Method	DemoTrust
Domain Environment File	/opt/bean/weblogic81/samples/domains/examples/setExamplesEnv.sh
Additional Command Option	-Dwlst.offline.log=disable -Duser.language=en_US

- Name:** Weblogic monitor resource name
- Type:** Monitor resource type
- Monitor Timing:** Timing to start monitoring
- Target Resource:** Resource to be monitored
- Interval (sec):** Interval between monitoring (in seconds)
- Timeout (sec):** Timeout for monitoring (in seconds)
- Do Not Retry at Timeout Occurrence:** Whether or not to retry when timeout occurs
- Do Not Execute Recovery Action at Timeout Occurrence:** Whether or not to execute recovery action when timeout occurs
- Retry Count:** The number of retries to be made from detection of an error in the monitor target to establish the error as an error
- Final Action:** Final action at detection of an error
- Execute Script before Reactivation:** Whether the pre-reactivation script is executed upon the detection of an error
- Execute Script before Failover:** Whether the pre-failover script is executed upon the detection of an error
- Execute Script before Final Action:** Whether the pre-final-action script is executed upon the detection of an error
- Recovery Target:** Target to be recovered when an error is detected
- Recovery Target Type:** Type of target to be recovered when an error is detected
- Recovery Script Threshold:** The number of times the recovery script is executed upon the detection of an error
- Reactivation Threshold:** The number of reactivations to be made at detection of an error
- Failover Threshold:** The number of failovers to be made at detection of an error
- Wait Time to Start Monitoring (sec):** Time to wait before starting monitoring (in seconds)
- Nice Value:** Monitor resource nice value
- Monitor Suspend Possibility:** Possibility of suspending monitoring
- Dummy Failure Possibility:** Possibility of Dummy Failure
- Collect Dump at Timeout Occurrence:** Whether or not dump of monitor process is collected when timeout occurs
- Run Migration Before Run Failover:** Whether or not migration is run before running failover
- Authority Method:** Authority method of Weblogic

Domain Environment File:  
Additional Command Option

Domain environment file of Weblogic  
Option to be passed to the [webLogic.WLST] command

## Understanding Websphere monitor resources

Websphere monitor resource monitors Websphere that operates on servers.

### Note on Websphere monitor resources

For the supported versions of Websphere, see “Software Applications supported by monitoring options” in Chapter 3, “Installation requirements for EXPRESSCLUSTER” in the *Getting Started Guide*.

A Java environment is required to start monitoring with this monitor resource. The application server system uses Java functions. If Java stalls, it may be recognized as an error.

### How Websphere monitor resources perform monitoring

Websphere monitor resource monitors the following:

This monitor resource monitors the following:

Executes monitoring of the application server by using the `serverStatus.sh` command.

The monitor resource determines the following result as an error:

(1) an error is reported with the state of the acquired application server.

## Displaying and changing the Websphere monitor resource details

1. Click the **Monitors** icon on the tree view displayed on the left side of the Builder window.
2. List of the monitor resources is displayed in the table view on the right side of the screen. Right-click the target Websphere monitor resource, and click the **Monitor(special)** tab in the **Monitor Resource Property** window.
3. On the **Monitor(special)** tab, you can see and/or change the detailed settings by following the description below.

The screenshot shows a dialog box titled "[wasw1] Monitor Resource Properties". It has four tabs: "Info", "Monitor(common)", "Monitor(special)", and "Recovery Action". The "Monitor(special)" tab is selected. The dialog contains the following fields:

Application Server Name	server1
Profile Name	default
User Name	user1
Password	password1
Install Path	/opt/IBMWebSphere/AppServer

At the bottom right, there are three buttons: "OK", "Cancel", and "Apply".

**Application Server Name** (Within 255 bytes)

Specify the application server name to be monitored. You must specify the name.

Default value: server1

**Profile Name** (Within 1023 bytes)

Specify the profile name of Websphere. You must specify the name.

Default value: default

**User Name** (Within 255 bytes)

Specify the user name of Websphere. You must specify the name.

Default value: None

**Password** (Within 255 bytes)

Specify the password of Websphere.

Default value: None

**Install Path** (Within 1023 bytes)

Specify the installation path of Websphere. You must specify the path.

Default value: /opt/IBM/WebSphere/AppServer



## Displaying the Websphere monitor resource properties with the WebManager

1. Start the WebManager.
2. When you click an object for a WebManager monitor resource  in the tree view, the following information is displayed in the list view.

Properties		Value
Comment		
Application Server Name		server1
Status		Normal
Resource Status on Each Server		
Server Name		Status
server1		Normal
server2		Offline

Comment:

Application Server Name:

Status:

Server Name:

Status:

Comment on the Websphere monitor resource

Monitor target application server name

Websphere monitor resource status

Server Name

Status of the monitor resource on the server

When you click **Details**, the following information is displayed in the pop-up dialog box:

Properties	Value
Name	wasw1
Type	wasw
Monitor Timing	Activating
Target Resource	exec1
Interval (sec)	60
Timeout (sec)	120
Do Not Retry at Timeout Occurrence	Off
Do Not Execute Recovery Action at Timeout Occurrence	Off
Retry Count	2
Final Action	Stop the cluster service and shutdown OS
Execute Script Before Reactivation	Off
Execute Script Before Failover	Off
Execute Script before Final Action	Off
Recovery Target	LocalServer
Recovery Target Type	Itself
Recovery Script Threshold	0
Reactivation Threshold	0
Failover Threshold	0
Wait Time to Start Monitoring (sec)	0
Nice Value	0
Monitor Suspend Possibility	Possible
Dummy Failure Possibility	Possible
Collect Dump at Timeout Occurrence	Off
Run Migration Before Run Failover	Off
Profile Name	default
Install Path	/opt/IBM/WebSphere/AppServer

**Name:** Websphere monitor resource name  
**Type:** Monitor resource type  
**Monitor Timing:** Timing to start monitoring  
**Target Resource:** Resource to be monitored  
**Interval (sec):** Interval between monitoring (in seconds)  
**Timeout (sec):** Timeout for monitoring (in seconds)  
**Do Not Retry at Timeout Occurrence:** Whether or not to retry when timeout occurs  
**Do Not Execute Recovery Action at Timeout Occurrence:** Whether or not to execute recovery action when timeout occurs  
**Retry Count:** The number of retries to be made from detection of an error in the monitor target to establish the error as an error  
**Final Action:** Final action at detection of an error  
**Execute Script before Reactivation:** Whether the pre-reactivation script is executed upon the detection of an error  
**Execute Script before Failover:** Whether the pre-failover script is executed upon the detection of an error  
**Execute Script before Final Action:** Whether the pre-final-action script is executed upon the detection of an error  
**Recovery Target:** Target to be recovered when an error is detected  
**Recovery Target Type:** Type of target to be recovered when an error is detected  
**Recovery Script Threshold:** The number of times the recovery script is executed upon the detection of an error  
**Reactivation Threshold:** The number of reactivations to be made at detection of an error  
**Failover Threshold:** The number of failovers to be made at detection of an error  
**Wait Time to Start Monitoring (sec):** Time to wait before starting monitoring (in seconds)  
**Nice Value:** Monitor resource nice value  
**Monitor Suspend Possibility:** Possibility of suspending monitoring  
**Dummy Failure Possibility:** Possibility of Dummy Failure

Collect Dump at Timeout Occurrence:	Whether or not dump of monitor process is collected when timeout occurs
Run Migration Before Run Failover:	Whether or not migration is run before running failover
Profile Name:	Profile name of Websphere
Install Path:	Install path of Websphere

## Understanding WebOTX monitor resources

WebOTX monitor resource monitors WebOTX that operates on servers.

### Note on WebOTX monitor resources

For the supported versions of WebOTX, see “Software Applications supported by monitoring options” in Chapter 3, “Installation requirements for EXPRESSCLUSTER” in the *Getting Started Guide*.

A Java environment is required to start monitoring with this monitor resource. The application server system uses Java functions. If Java stalls, it may be recognized as an error.

### How WebOTX monitor resources perform monitoring

WebOTX monitor resource monitors the following:

This monitor resource monitors the following:

Executes monitoring of the application server by using the `otxadmin.sh` command.

The monitor resource determines the following result as an error:

(1) an error is reported with the state of the acquired application server.

## Displaying and changing the WebOTX monitor resource details

1. Click the **Monitors** icon on the tree view displayed on the left side of the Builder window.
2. List of the monitor resources is displayed in the table view on the right side of the screen. Right-click the target WebOTX monitor resource, and click the **Parameter** tab in the **Monitor Resource Property** window.
3. On the **Parameter** tab, you can see and/or change the detailed settings by following the description below.

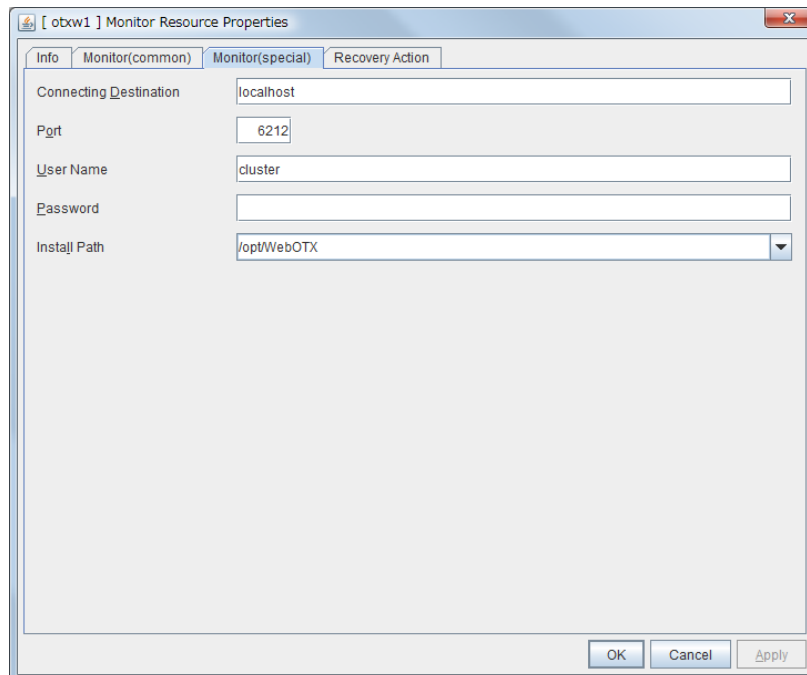

### **Connecting Destination** (Within 255 bytes)

Specify the server name to be monitored. You must specify the name.

Default value: localhost

### **Port** (1 to 65535)

Specify the port number used to connect to the server. You must specify the number.

When monitoring a WebOTX user domain, specify the management port number for the WebOTX domain. The management port number is the number which was set for "domain.admin.port" of <domain\_name>.properties when the domain was created. Refer to the WebOTX documents for details of <domain\_name>.properties.

Default value: 6212

### **User Name** (Within 255 bytes)

Specify the user name of WebOTX. You must specify the name.

When monitoring a WebOTX user domain, specify the login user name for the WebOTX domain.

Default value: None

**Password** (Within 255 bytes)

Specify the password of WebOTX.

Default value: None

**Install Path** (Within 1023 bytes)

Specify the installation path of WebOTX. You must specify the path.

Default value: /opt/WebOTX

## Displaying the WebOTX monitor resource properties with the WebManager

1. Start the WebManager.
2. When you click an object for a WebManager monitor resource  in the tree view, the following information is displayed in the list view.

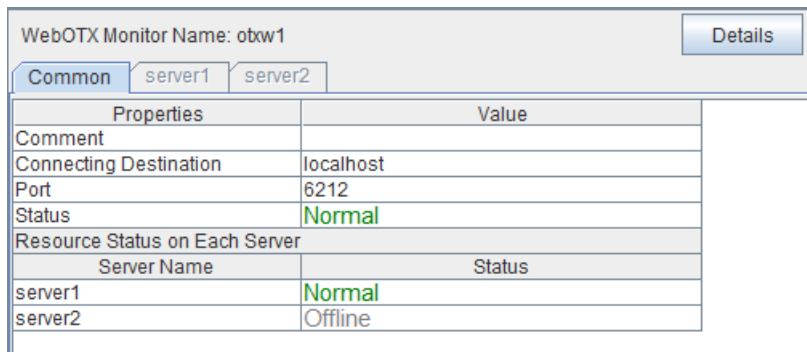

Properties	Value
Comment	
Connecting Destination	localhost
Port	6212
Status	Normal
Resource Status on Each Server	
Server Name	Status
server1	Normal
server2	Offline

Comment: Comment on the WebOTX monitor resource  
 Connecting Destination: Monitor target application server name  
 Port: The port number used to connect to the server.  
 Status: WebOTX monitor resource status

Server Name: Server Name  
 Status: Status of the monitor resource on the server



When you click **Details**, the following information is displayed in the pop-up dialog box:

Properties	Value
Name	otbw1
Type	otbw
Monitor Timing	Activating
Target Resource	exec1
Interval (sec)	60
Timeout (sec)	120
Do Not Retry at Timeout Occurrence	Off
Do Not Execute Recovery Action at Timeout Occurrence	Off
Retry Count	1
Final Action	Stop the cluster service and shutdown OS
Execute Script Before Reactivation	Off
Execute Script Before Failover	Off
Execute Script before Final Action	Off
Recovery Target	LocalServer
Recovery Target Type	Itself
Recovery Script Threshold	0
Reactivation Threshold	0
Failover Threshold	0
Wait Time to Start Monitoring (sec)	0
Nice Value	0
Monitor Suspend Possibility	Possible
Dummy Failure Possibility	Possible
Collect Dump at Timeout Occurrence	Off
Run Migration Before Run Failover	Off
Install Path	/opt/WebOTX

Name:	WebOTX monitor resource name
Type:	Monitor resource type
Monitor Timing:	Timing to start monitoring
Target Resource:	Resource to be monitored
Interval (sec):	Interval between monitoring (in seconds)
Timeout (sec):	Timeout for monitoring (in seconds)
Do Not Retry at Timeout Occurrence:	Whether or not to retry when timeout occurs
Do Not Execute Recovery Action at Timeout Occurrence:	Whether or not to execute recovery action when timeout occurs
Retry Count:	The number of retries to be made from detection of an error in the monitor target to establish the error as an error
Final Action:	Final action at detection of an error
Execute Script before Reactivation:	Whether the pre-reactivation script is executed upon the detection of an error
Execute Script before Failover:	Whether the pre-failover script is executed upon the detection of an error
Execute Script before Final Action:	Whether the pre-final-action script is executed upon the detection of an error
Recovery Target:	Target to be recovered when an error is detected
Recovery Target Type:	Type of target to be recovered when an error is detected
Recovery Script Threshold:	The number of times the recovery script is executed upon the detection of an error
Reactivation Threshold:	The number of reactivations to be made at detection of an error
Failover Threshold:	The number of failovers to be made at detection of an error
Wait Time to Start Monitoring (sec):	Time to wait before starting monitoring (in seconds)
Nice Value:	Monitor resource nice value
Monitor Suspend Possibility:	Possibility of suspending monitoring
Dummy Failure Possibility:	Possibility of Dummy Failure

Collect Dump at Timeout Occurrence:	Whether or not dump of monitor process is collected when timeout occurs
Run Migration Before Run Failover:	Whether or not migration is run before running failover
Install Path:	Install path of WebOTX

## Understanding JVM monitor resources

JVM monitor resources monitor information about the utilization of resources that are used by Java VM or an application server running on a server.

### Note on JVM monitor resources

The **Java installation path** on the **JVM Monitor** tab of **Cluster Properties** must be set before adding JVM monitor resource.

For a target resource, specify an application server running on Java VM such as WebLogic Server or WebOTX. As soon as the JVM monitor resource has been activated, the Java Resource Agent starts monitoring, but if the target (WebLogic Server or WebOTX) cannot start running immediately after the activation of the JVM monitor resource, use **Wait Time to Start Monitoring** to compensate.

The setting of Monitor(common) tab-Retry Count is invalid. When you'd like to delay error detection, please change the setting of Cluster Properties-JVM monitor Tab-Resource Measurement Settings [Common]-Retry Count.

### How JVM monitor resources perform monitoring

JVM monitor resource monitors the following:

Monitors application server by using JMX (Java Management Extensions).

The monitor resource determines the following results as errors:

- Target Java VM or application server cannot be connected
- The value of the used amount of resources obtained for the Java VM or application server exceeds the user-specified threshold a specified number of times (error decision threshold) consecutively

As a result of monitoring, an error is regarded as having been solved if:

- The used amount of resources obtained for the Java VM or application server remains below the user-specified threshold the number of times specified by the error decision threshold.

---

**Note:**

**Collect Cluster Logs** in the WebManager **Tools** menu does not handle the configuration file and log files of the target (WebLogic Server or WebOTX).

---

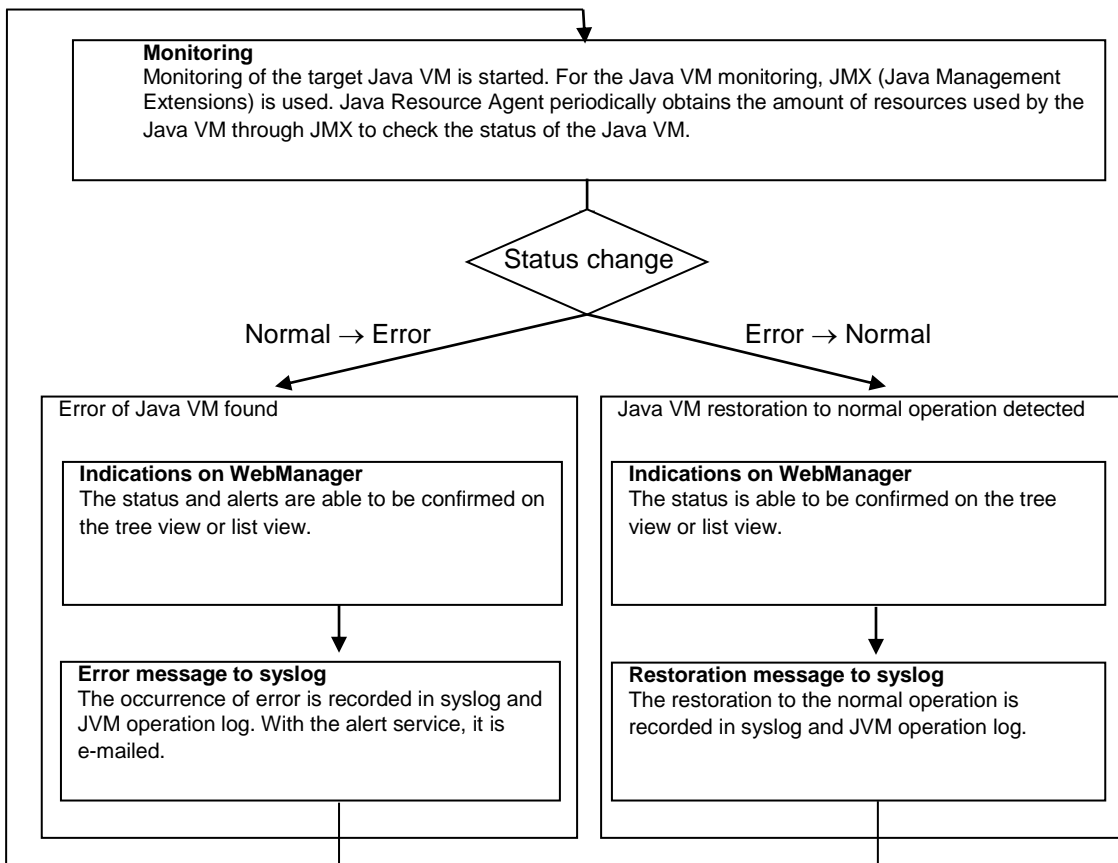

The standard operations when the threshold is exceeded are as described below.

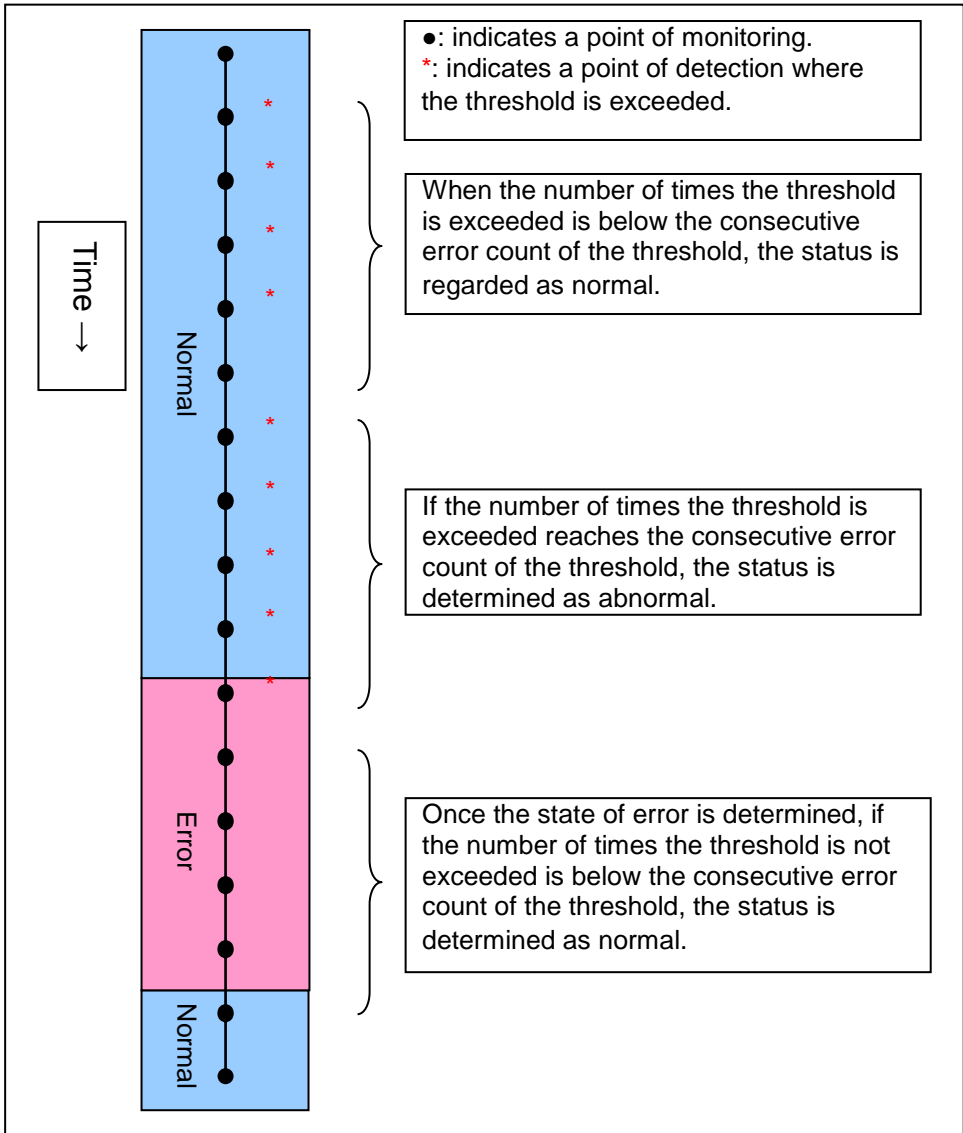

The operations performed if an error persists are as described below.

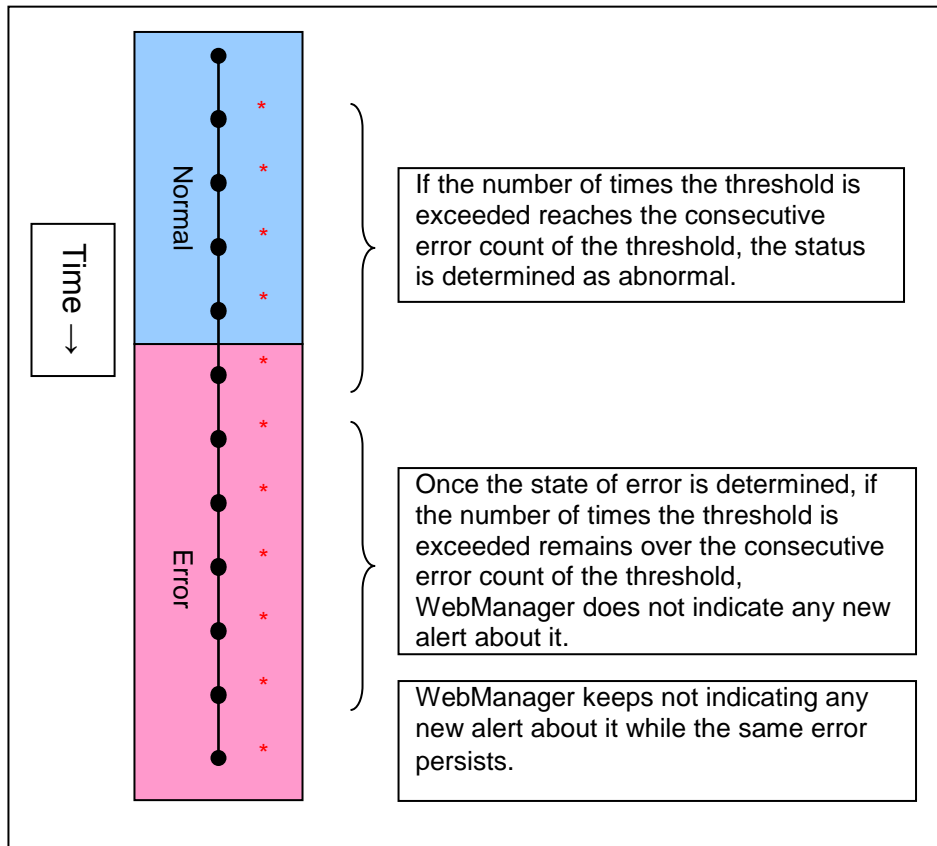

The following example describes the case of monitoring Full GC (Garbage Collection). The JVM monitor resource recognizes a monitor error if Full GC is detected consecutively the number of times specified by the error threshold. In the following chart, \* indicates that Full GC is detected by the JVM monitor resource when the error threshold is set to 5 (times). Full GC has a significant influence on the system, thus the recommended error threshold is 1 time.

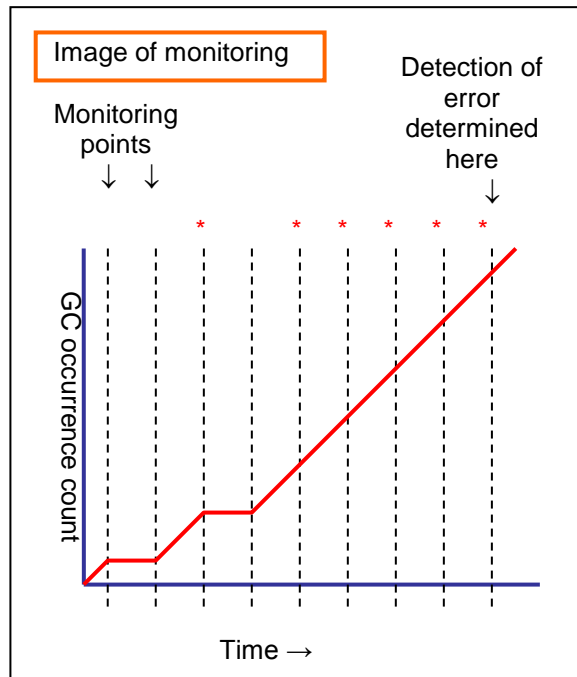

## Linking with the load balancer (health check function)

Target load balancer: Load balancer with health check function for HTML files

JVM monitor resources can link with the load balancer. This section describes an example of linking when WebOTX is used as the application to be monitored. The load balancer linkage provides a health check function and target Java VM load calculation function. To link with the BIG-IP Local Traffic Manager, see "Linking with the BIG-IP Local Traffic Manager".

Distributed nodes are servers that are subject to load balancing, while the distributed node module is installed in the distributed nodes. The distributed node module is included in Express5800/LB400\*, MIRACLE LoadBalancer. For Express5800/LB400\*, refer to the *Express5800/LB400\* User's Guide (Software)*. For load balancers other than Express5800/LB400\*, refer to the relevant manual.

To use the function, configure the settings through the Builder Cluster Properties - **JVM monitor** tab - **Load Balancer Linkage Settings** dialog box; the health check function of the load balancer is linked.

When a load balancing system is configured with the load balancer on the server, the JVM monitor resource renames the HTML file specified by **HTML File Name** to the name specified by **HTML Renamed File Name** upon the detection of a WebOTX error (for example, exceeding the threshold for collected information).

The JVM monitor resource halts for the wait time, or 20 seconds, after renaming the HTML file. The wait time is intended to prevent WebOTX from being restarted before the load balancer finishes disconnecting the distributed node.

Once the JVM monitor resource detects the normality of WebOTX (e.g., the threshold specified for the collected information is not exceeded after reconnection) after WebOTX rebooting, the HTML file name set with **HTML Renamed File Name** is restored to that specified by **HTML File Name**.

The load balancer periodically health-checks the HTML file, and if a health check fails, the distributed node is determined to be not alive, so that the load balancer disconnects that distributed node. In the case of Express5800/LB400\*, configure the health check interval, health check timeout, and retry count to determine the node down state by the health check with the health check (distributed node) interval parameter, HTTP health check timeout parameter, and health check (distributed node) count parameter, that are accessible from **ManagementConsole** for the load balancer→**LoadBalancer**→**System Information**. For how to configure load balancers other than Express5800/LB400\*, refer to the relevant manual.

Configure the parameters using the following as a reference.

20-second wait time  $\geq$  (health check (distributed node) interval + HTTP health check timeout) x health check (distributed node) count

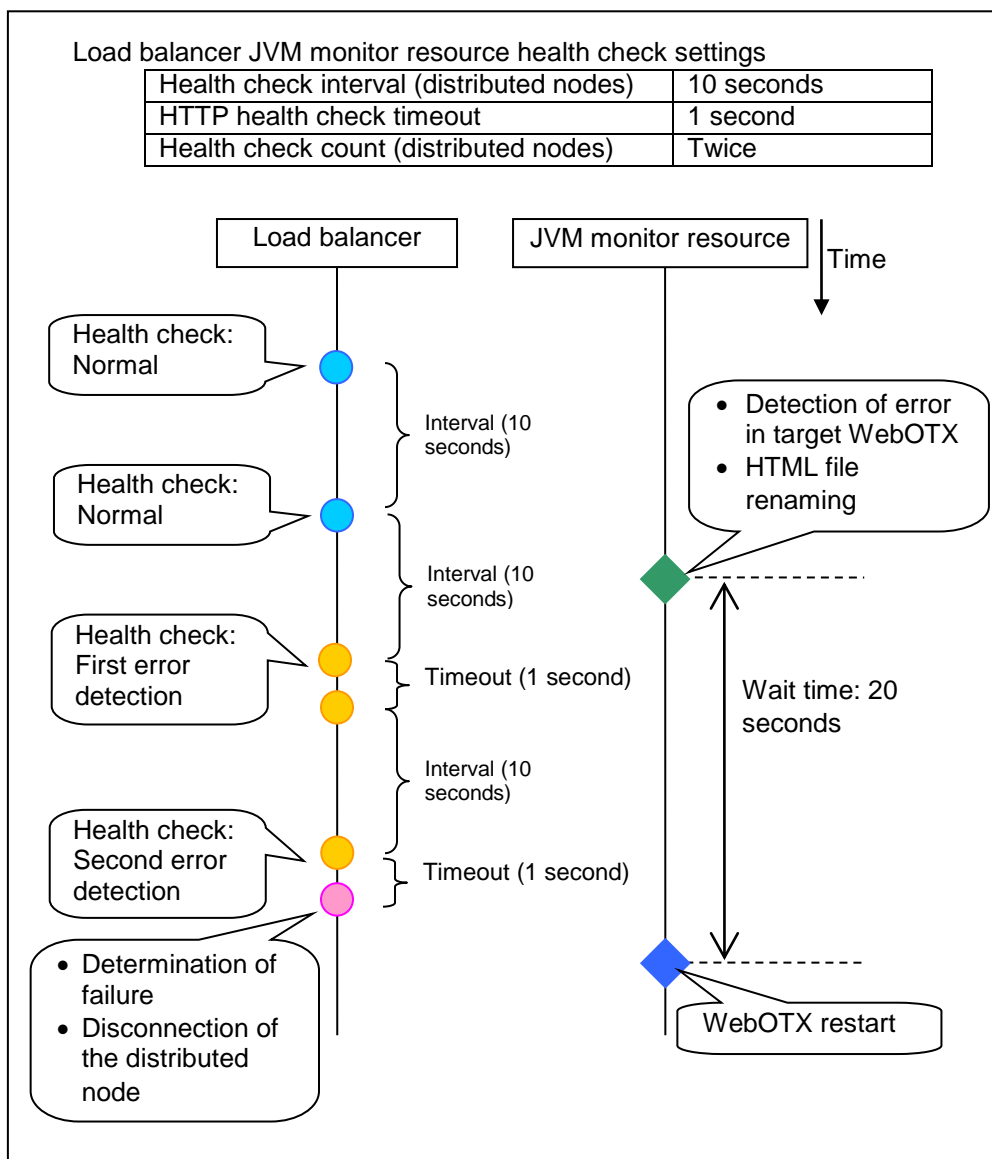



## Linking with the load balancer (target Java VM load calculation function)

Target load balancer: Express5800/LB400\*, MIRACLE LoadBalancer

JVM monitor resources can link with the load balancer. This section describes an example of linking when WebOTX is used as the application to be monitored. The load balancer linkage provides a health check function and target Java VM load calculation function. To link with the BIG-IP Local Traffic Manager, see “Linking with the BIG-IP Local Traffic Manager”.

Distributed nodes are servers that are subject to load balancing, while the distributed node module is installed in the distributed node. The distributed node module is included in Express5800/LB400\*, MIRACLE LoadBalancer. For Express5800/LB400\*, refer to the *Express5800/LB400\* User's Guide (Software)*. For load balancers other than Express5800/LB400\*, refer to the relevant manual.

To use this function, the following settings are required. This function works together with the CPU load-dependent weighting function of the load balancer.

- **Properties - Monitor(special) tab** → **Tuning property - Memory** dialog box - **Monitor Heap Memory Rate - Total Usage**
- **Properties - Monitor(special) tab** → **Tuning property - Load Balancer Linkage** dialog box - **Memory Pool Monitor**

According to the following steps, first install the distributed node module on each server, and then execute the load balancer linkage setup command `clpjra_lbsetup.sh` to configure the distributed node modules.

---

### Note:

Execute the command from an account having the root privilege.

---

1. Execute “<EXPRESSCLUSTER\_installation\_folder>/ha/jra/bin/clpjra\_lbsetup.sh.” The functions of the arguments are as described below.  
(Example) `clpjra_lbsetup.sh -e 1 -i 120 -t 180`

Argument	Description	Value
-e	Enables or disables the function.	0 or 1 0: Disable 1: Enable
-i	Specify the execution interval for the target Java VM load calculation command, in seconds.	1 to 2147483646
-t	Specify the timeout for the target Java VM load calculation command, in seconds.	1 to 2147483646

The JVM monitor resource calculates the load on the target Java VM according to the information obtained about the Java memory. Obtain the Java VM load from the following expression. The threshold is the value obtained by multiplying the entire amount of the Java heap area by the use ratio set with the **Monitor(special)** tab - **Tuning** property - **Memory** tab - **Monitor Heap Memory Rate - Total Usage**.

$$\text{Java VM load (\%)} = \text{current memory usage (MB)} \times 100 / \text{threshold (MB)}$$

For the distributed node module installed on a server on which JVM monitor resource is running, commands are periodically executed to compare the obtained target Java VM load with the CPU load obtained separately, and to notify the load balancer of the higher load value as a CPU load. The load balancer distributes the traffic (requests) to the appropriate servers according to the CPU load of the distributed node.

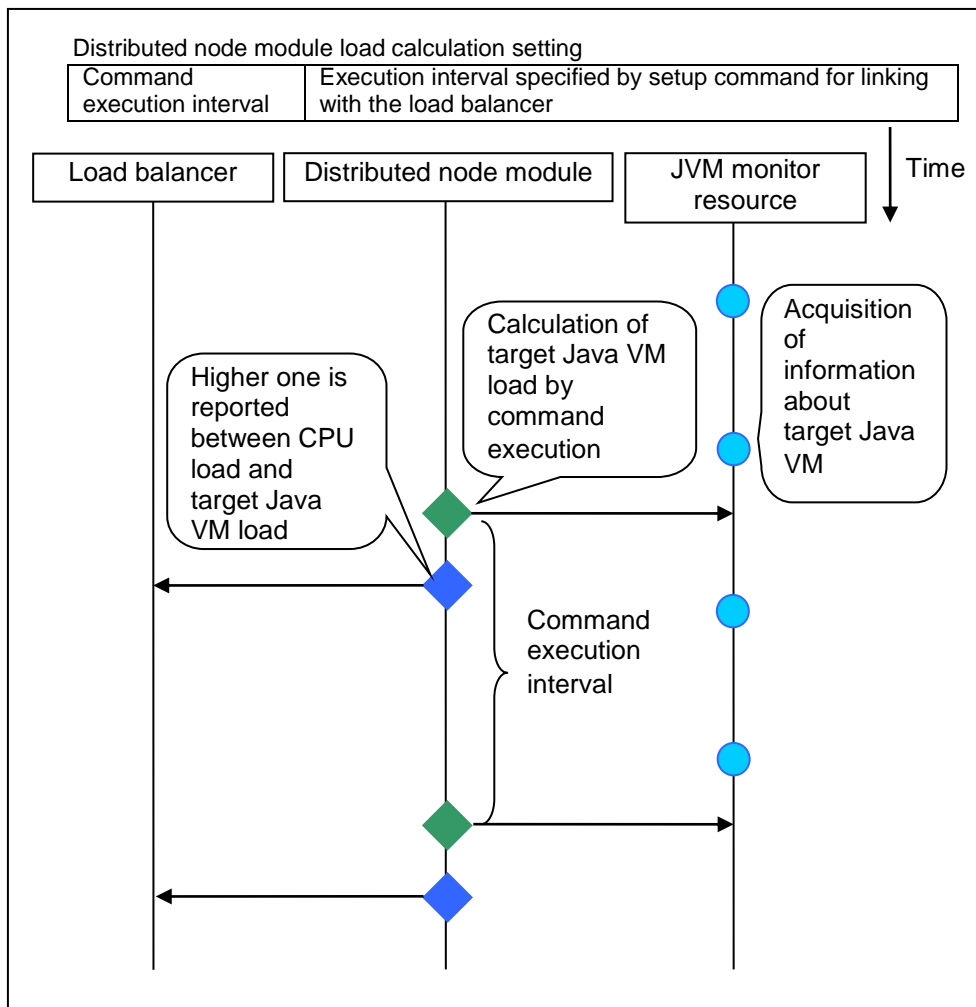

## Linking with the BIG-IP Local Traffic Manager

Target load balancer: BIG-IP Local Traffic Manager

The JVM monitor resource can link with BIG-IP LTM. Hereafter, the explanation assumes the use of Tomcat as the application server to be monitored. Linkage with BIG-IP LTM offers the distributed node control function and the target Java VM load calculation function.

The linkage between BIG-IP LTM and the JVM monitor resource is realized with the BIG-IP series API (iControl).

The distributed node is the load distribution server, and the linkage module is that which is installed in each distributed node. The linkage module is contained in Java Resource Agent.

To use the distributed node control function, specify the setting with **Builder Cluster Properties** -> **JVM Monitor** tab -> **Load Balancer Linkage Settings** dialog box, **JVM monitor resource Properties - Monitor(special)** tab - **Tuning** property - **Load Balancer Linkage** tab.

To use the target Java VM load calculation function, specify the setting with **Builder Cluster Properties** -> **JVM Monitor** tab -> **Load Balancer Linkage Settings** dialog box.

The following BIG-IP LTM linkage error message is output to the JVM operation log. For details, see “JVM monitor resource log output messages.”

```
Error: Failed to operate clpjra_bigip.[error code]
```

If the relevant server configures the BIG-IP LTM load distribution system, when the JVM monitor detects a Tomcat failure (for example: the amount of collection information exceeds the specified threshold), iControl is used to update the BIG-IP LTM distributed node status from “enable” to “disable.”

After updating the status of the distributed node of BIG-IP LTM, the JVM monitor waits until the number of connections of the distributed node falls to 0. After waiting, it executes **Restart Command** specified on the JVM monitor resource **Properties - Monitor(special)** tab -> **Tuning** property - **Load Balancer Linkage** tab. It does not execute the action specified by **Restart Command** if the number of connections of the distributed node does not fall to 0, even if **Timeout** elapses, as specified on the **JVM monitor resource Properties - Monitor(special)** tab -> **Tuning** property - **Load Balancer Linkage** tab.

When the JVM monitor detects a Tomcat failure recovery, it uses iControl to update the status of the BIG-IP LTM distributed node from “disable” to “enable.” In this case, it does not execute the action specified by **Restart Command** specified on the JVM monitor resource **Properties - Monitor(special)** tab -> **Tuning** property - **Load Balancer Linkage** tab.

If the distributed node status is “disable”, BIG-IP LTM determines the distributed node to be down and therefore disconnects it. Use of the distributed node control function requires no related setting for BIG-IP LTM.

The distributed node status is updated by BIG-IP LTM when the JVM monitor detects a failure or failure recovery. Therefore, after the failover generated by an operation other than JVM monitoring, the distributed node status of BIG-IP LTM may be “enable”.

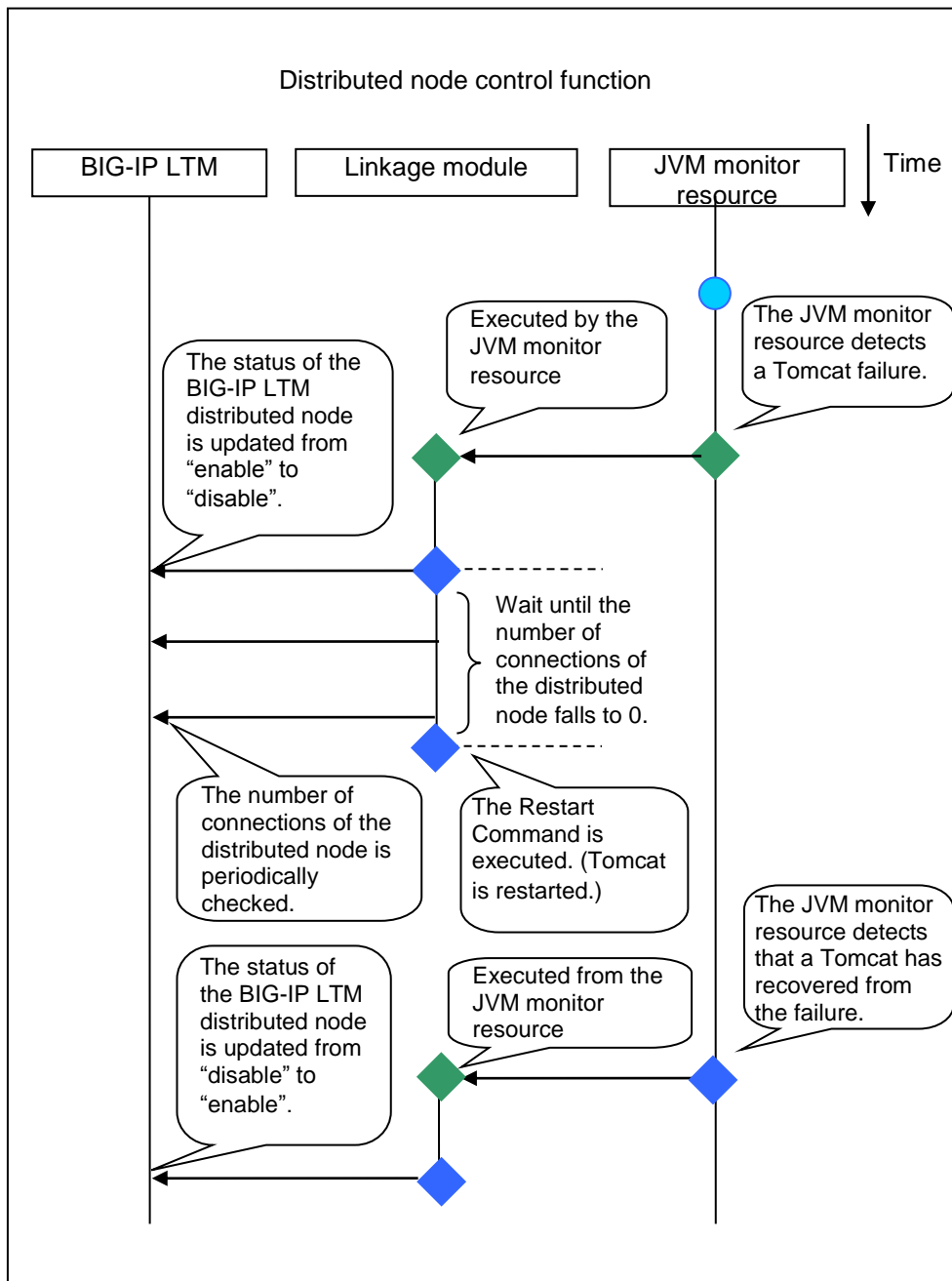

The JVM monitoring calculates the load on the target Java VM according to the information obtained about the Java memory.

Obtain the Java VM load from the following expression. Java VM load (%) is the value obtained by multiplying the entire amount of the Java heap area by the use ratio set with **Monitor(special)** tab - **Tuning** property - **Memory** tab - **Monitor Heap Memory Rate** - **Total Usage**.

$$\text{Java VM load (\%)} = \text{current memory usage (MB)} \times 100 / \text{threshold (MB)}$$

The linkage module installed on the server on which the JVM monitor runs executes a command at regular intervals, and reports the load collected on the target Java VM to BIG-IP LTM. BIG-IP LTM distributes the traffic (request) to the optimal server according to the load status of Java VM of the distributed node.

Set the following EXPRESSCLUSTER settings with the Builder.

- **JVM monitor resource**

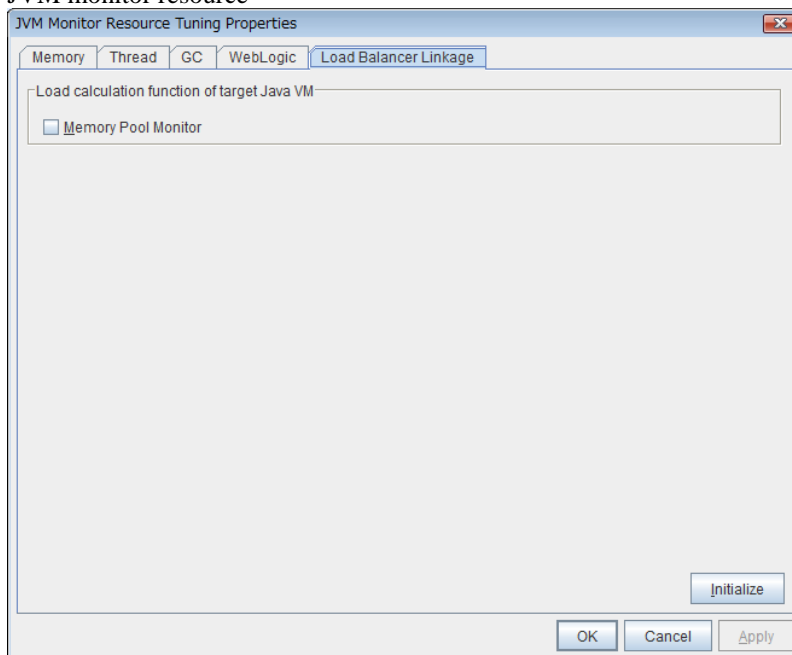

**Properties - Monitor(special) tab -> Tuning property - Load Balancer Linkage tab**  
 Select the **Memory Pool Monitor** check box.

- **Custom monitor resource**

**Properties - Monitor(common) tab**  
 Select the **Monitor Timing - Always** radio button.

**Properties - Monitor(special) tab**

Select **Script created with this product**.

Select **File - Edit** and then add the following **boldfaced** section.

```
-----
#! /bin/sh
#*****
#*          genw.sh          *
#*****

ulimit -s unlimited
`${CLP_PATH}/ha/jra/bin/clpjra_bigip weight
exit 0
-----
```

Select the **Monitor Type - Synchronous** radio button.

In the BIG-IP LTM setting, specify **Ratio(node)** in **LocalTraffic - Pools:PoolList - Relevant pool - Members - LoadBalancing - Load Balancing Method** of BIG-IP Configuration Utility.

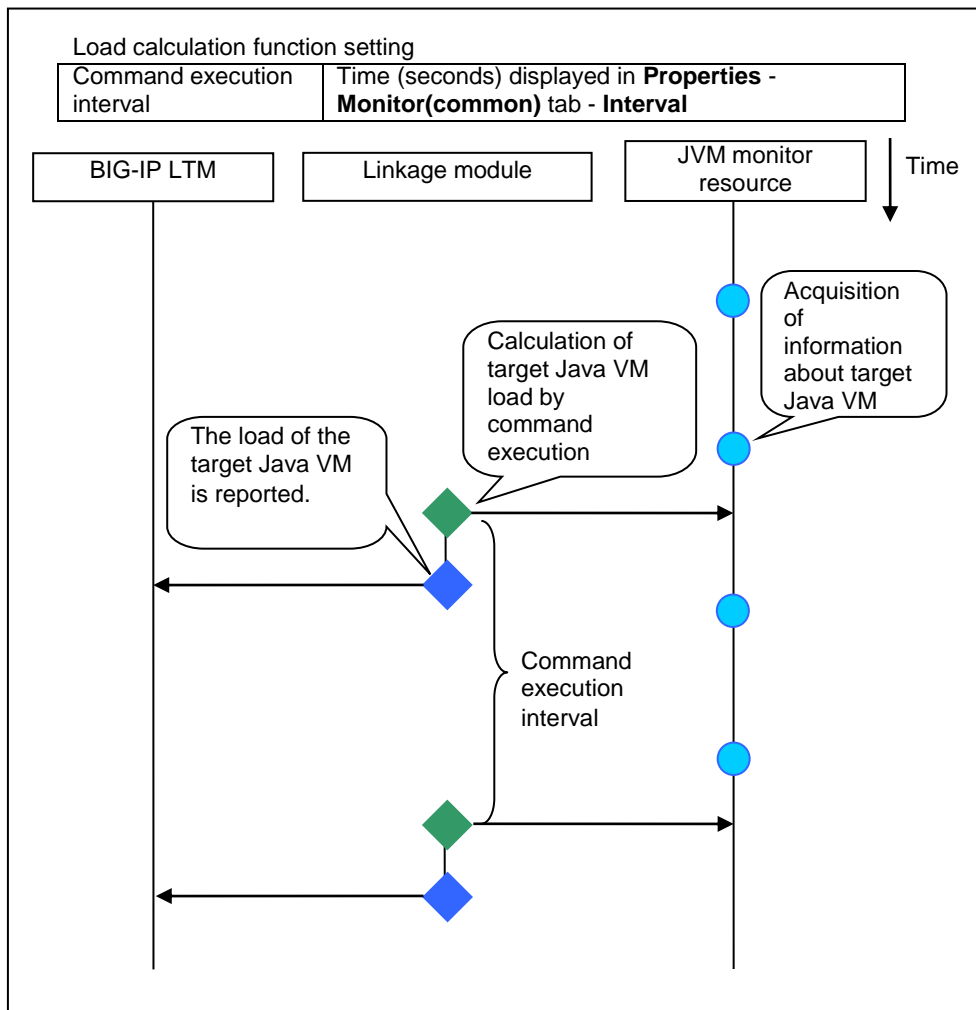

## JVM statistics log

JVM monitor resources collect statistics information on the monitor target Java VM. The information is stored in CSV-format files, as JVM statistics logs.

The following “monitor items” see the parameters on the [Monitor(special)] tab of [Properties] of the JVM monitor resources.

Statistical information is collected and output to its corresponding JVM statistical log when an item is selected and the threshold value is set for the item. If a monitor item is not selected, statistical information on the item will be neither collected nor output to its corresponding JVM statistical log.

The following table lists the monitor items and the corresponding JVM statistics logs.

Monitor items	Corresponding JVM statistics log
[Memory] tab - [Monitor Heap Memory Rate] [Memory] tab - [Monitor Non-Heap Memory Rate]	jramemory.stat
[Thread] tab - [Monitor the number of Active Threads]	jrathread.stat
[GC] tab - [Monitor the time in Full GC] [GC] tab - [Monitor the count of Full GC execution]	jragc.stat
[Memory] tab - [Monitor Virtual Memory Usage]	jraruntime.stat
[WebLogic] tab - [Monitor the requests in Work Manager]	wlworkmanager.stat
[WebLogic] tab - [Monitor the requests in Thread Pool]	wlthreadpool.stat

## Java memory area usage check on monitor target Java VM (jramemory.stat)

The jramemory.stat log file records the size of the Java memory area used by the monitor target Java VM. Its file name will be either of the following, depending on the Rotation Type selected in the Log Output Setting dialog box.

- When Cluster Properties - [JVM monitor] tab - [Log Output Setting] - [Rotation Type] - [File Capacity] is selected: jramemory<integer\_starting\_with\_0>.stat
- When Cluster Properties - [JVM monitor] tab - [Log Output Setting] - [Rotation Type] - [Period] is selected: jramemory<YYYYMMDDhhmm>.stat

The data format is as follows.

No	Format	Description
1	yyyy/mm/dd hh:mm:ss.SSS	Date and time of log recording
2	Half-size alphanumeric characters and symbols	Name of the monitor target Java VM; this is specified in [Properties] - [Monitor(special)] tab - [Identifier] in JVM monitor resources.
3	Half-size alphanumeric characters and symbols	Name of the Java memory pool; for details, refer to “Java memory pool name”.
4	Half-size alphanumeric characters and symbols	Type of Java memory pool Heap, Non-Heap
5	Half-size numeric characters	Memory size that the Java VM requests from the OS at startup; this is expressed in bytes. (init) At the startup of the monitor target Java VM, the size can be specified using the following Java VM startup options. <ul style="list-style-type: none"> <li>• HEAP:-Xms</li> <li>• NON_HEAP permanent area (Perm Gen): -XX:PermSize</li> <li>• NON_HEAP code cache area (Code Cache): -XX:InitialCodeCacheSize</li> </ul>
6	Half-size numeric characters	Memory size currently used by the Java VM; this is

		expressed in bytes. (used)
7	Half-size numeric characters	Memory size guaranteed for use by the operation of the Java VM; this is expressed in bytes. (committed) This size varies depending on the memory use; it is always equal to the value of “used” or larger but equal to or smaller than the value of “max”.
8	Half-size numeric characters	Maximum memory size that the Java VM can use; this is expressed in bytes. (max) The size can be specified using the following Java VM startup options. <ul style="list-style-type: none"> <li>• HEAP:-Xmx</li> <li>• NON_HEAP permanent area (Perm Gen): -XX:MaxPermSize</li> <li>• NON_HEAP code cache area (Code Cache): -XX:ReservedCodeCacheSize</li> </ul> <p>Example)</p> <pre>java -XX:MaxPermSize=128m -XX:ReservedCodeCacheSize=128m javaAP</pre> <p>In this example, max of NON_HEAP becomes 128 m + 128 m = 256 m.</p> <p>(Note)</p> <p>When the same value is specified for -Xms and -Xmx, “init” may become larger than “max”. This is because “max” of HEAP is determined by subtracting half the size of the Survivor Space from the area size determined by the specification of -Xmx.</p>
9	Half-size numeric characters	Peak size of the memory used after startup of the measurement target Java VM; when the name of the Java memory pool is HEAP or NON_HEAP, this size becomes equal to that of the memory currently used by the Java VM (used). This is expressed in bytes.
10	Half-size numeric characters	Memory size equal to “max” (No. 8 field) × the threshold (%) when the Java memory pool type (No. 4 field) is HEAP; it is expressed in bytes. When the Java memory pool type is other than HEAP, it is 0.

## Thread operation status check on monitor target Java VM (jthread.stat)

The jthread.stat log file records the thread operation status of the monitor target Java VM. Its file name will be either of the following depending on the Rotation Type selected in the Log Output Setting dialog box.

- When Cluster Properties - [JVM monitor] tab - [Log Output Setting] - [Rotation Type] - [File Capacity] is selected: jthread<integer\_starting\_with\_0>.stat
- When Cluster Properties - [JVM monitor] tab - [Log Output Setting] - [Rotation Type] - [Period] is selected: jthread<YYYYMMDDhhmm>.stat

The data format is as follows.

No	Format	Description
1	yyyy/mm/dd hh:mm:ss.SSS	Date and time of log recording
2	Half-size alphanumeric characters and symbols	Name of the monitor target Java VM; this is specified in [Properties] - [Monitor(special)] tab - [Identifier] in JVM monitor resources.



3	Half-size alphanumeric characters and symbols	Number of active threads in the monitor target Java VM
4	[Half-size numeric characters: half-size numeric characters:...]	Deadlocked thread ID in the monitor target Java VM; this contains the IDs of all the deadlocked threads, in order.
5	Half-size alphanumeric characters and symbols	Detailed information on deadlocked threads in the monitor target Java VM; it contains information on all the deadlocked threads, in order, in the following format. ThreadName, ThreadID, ThreadStatus, UserTime, CpuTime, WaitedCount, WaitedTime, isInNative, isSuspended <line feed> stacktrace<line feed> : stacktrace<line feed> stacktrace=ClassName, FileName, LineNumber, MethodName, isNativeMethod

### GC operation status check on monitor target Java VM (jragc.stat)

The jragc.stat log file records the GC operation status of the monitor target Java VM. Its file name will be either of the following, depending on the Rotation Type selected in the Log Output Setting dialog box.

- When Cluster Properties - [JVM monitor] tab - [Log Output Setting] - [Rotation Type]-[File Capacity] is selected: jragc<integer\_starting\_with\_0>.stat
- When Cluster Properties - [JVM monitor] tab - [Log Output Setting] - [Rotation Type] - [Period] is selected: jragc<YYYYMMDDhhmm>.stat

JVM monitor resources output two types of GC information: Copy GC and Full GC.

With Oracle Java, JVM monitor resources count the increment in the count of execution of the following GC as Full GC.

- MarkSweepCompact
- MarkSweepCompact
- PS MarkSweep
- ConcurrentMarkSweep

The data format is as follows.

No	Format	Description
1	yyyy/mm/dd hh:mm:ss.SSS	Date and time of log recording
2	Half-size alphanumeric characters and symbols	Name of the monitor target Java VM; this is specified in [Properties] - [Monitor(special)] tab - [Identifier] in JVM monitor resources.
3	Half-size alphanumeric characters and symbols	GC name of monitor target Java VM  <b>When the monitor target Java VM is Oracle Java</b> The GC name to be indicated is one of the following. Copy MarkSweepCompact MarkSweepCompact PS Scavenge PS MarkSweep ParNew ConcurrentMarkSweep

		<p><b>When the monitor target Java VM is Oracle JRockit</b></p> <p>The GC name to be indicated is one of the following.</p> <p>Garbage collection optimized for throughput Old Collector</p> <p>Garbage collection optimized for short pausetimes Old Collector</p> <p>Garbage collection optimized for deterministic pausetimes Old Collector</p> <p>Static Collector</p> <p>Static Old Collector</p> <p>Garbage collection optimized for throughput Young Collector</p>
4	Half-size numeric characters	Count of GC execution during the period from startup of the monitor target Java VM to measurement; the count includes the GC executed before the JVM monitor resource starts monitoring.
5	Half-size numeric characters	Total time in GC execution during the period from startup of the monitor target Java VM to measurement; this is expressed in milliseconds. This includes the time taken for the GC executed before the JVM monitor resource starts monitoring.

## Virtual memory usage check on monitor target Java VM (jraruntime.stat)

The jraruntime.stat log file records the size of the virtual memory used by the monitor target Java VM. Its file name will be either of the following depending on the Rotation Type selected in the Log Output Setting dialog box.

- When Cluster Properties - [JVM monitor] tab - [Log Output Setting] - [Rotation Type] - [File Capacity] is selected: jraruntime<integer\_starting\_with\_0>.stat
- When Cluster Properties - [JVM monitor] tab - [Log Output Setting] - [Rotation Type] - [Period] is selected: jraruntime<YYYYMMDDhhmm>.stat

The data format is as follows.

No	Format	Description
1	yyyy/mm/dd hh:mm:ss.SSS	Date and time of log recording
2	Half-size alphanumeric characters and symbols	Name of the monitor target Java VM; this is specified in [Properties] - [Monitor(special)] tab - [Identifier] in JVM monitor resources.
3	Half-size numeric characters	Start time of the monitor target Java VM, expressed in milliseconds
4	Half-size numeric characters	Operating time of the monitor target Java VM, expressed in milliseconds
5	Half-size alphanumeric characters and symbols	Size of the virtual memory used by the monitor target Java VM; this also includes the amount of memory used in the heap area, non-heap area, and stack area. [process_name:PID,size_of_memory_used:] This is expressed in bytes.

## Operation status check on Work Manager of WebLogic Server (wlworkmanager.stat)

The wlworkmanager.stat log file records the operation status of the Work Manager of the

WebLogic Server. Its file name will be either of the following depending on the Rotation Type selected in the Log Output Setting dialog box.

- When Cluster Properties - [JVM monitor] tab - [Log Output Setting] - [Rotation Type] - [File Capacity] is selected: `wlworkmanager<integer_starting_with_0>.stat`
- When Cluster Properties - [JVM monitor] tab - [Log Output Setting] - [Rotation Type] - [Period] is selected: `wlworkmanager<YYYYMMDDhhmm>.stat`

The data format is as follows.

No	Format	Description
1	yyyy/mm/dd hh:mm:ss.SSS	Date and time of log recording
2	Half-size alphanumeric characters and symbols	Name of the monitor target Java VM; this is specified in [Properties] - [Monitor(special)] tab - [Identifier] in JVM monitor resources.
3	Half-size alphanumeric characters and symbols	Application name
4	Half-size alphanumeric characters and symbols	Work Manager name
5	Half-size numeric characters	Request execution count
6	Half-size numeric characters	Number of wait requests

## Operation status check on Thread Pool of WebLogic Server (wlthreadpool.stat)

The `wlthreadpool.stat` log file records the operation status of the thread pool of the WebLogic Server. Its file name will be either of the following depending on the Rotation Type selected in the Log Output Setting dialog box.

- When Cluster Properties - [JVM monitor] tab - [Log Output Setting] - [Rotation Type] - [File Capacity] is selected: `wlthreadpool<integer_starting_with_0>.stat`
- When Cluster Properties - [JVM monitor] tab - [Log Output Setting] - [Rotation Type] - [Period] is selected: `wlthreadpool<YYYYMMDDhhmm>.stat`

The data format is as follows.

No	Format	Description
1	yyyy/mm/dd hh:mm:ss.SSS	Date and time of log recording
2	Half-size alphanumeric characters and symbols	Name of monitor target Java VM; this is specified in [Properties] - [Monitor(special)] tab - [Identifier] in JVM monitor resources.
3	Half-size numeric characters	Total request execution count
4	Half-size numeric characters	Number of requests queued in the WebLogic Server
5	Half-size numeric characters	Request execution per unit time count (seconds)
6	Half-size numeric characters	Number of threads for executing the application
7	Half-size numeric characters	Number of threads in idle state
8	Half-size numeric characters	Number of executing threads
9	Half-size numeric characters	The number of threads in stand-by state

## Java memory pool name

This section describes the Java memory pool name output as `memory_name` in messages to the JVM operation log file. It also describes the Java memory pool name output to the JVM statistics log file, `jramemory.stat` log file.

The character strings of the Java memory pool names are not determined by the JVM monitor resources. Character strings received from the monitor target Java VM are output as Java memory pool names.

Their specifications are not open for Java VM, and accordingly, are subject to change without notice with any version upgrade of Java VM. Therefore, we do not recommend monitoring Java memory pool names contained in messages.

The following monitor items see the parameters on the [Memory] tab of the [Monitor(special)] tab in [Properties] of the JVM monitor resources. The following Java memory pool names have been confirmed on actual machines running Oracle Java and JRockit.

When “-XX:+UseSerialGC” is specified as a startup option for the monitor target Java VM, the No. 3 Java memory pool name in the jramemory.stat log file will be as follows.

Monitor item	Character string output as memory_name
[Monitor Heap Memory Rate] - [Total Usage]	HEAP
[Monitor Heap Memory Rate] - [Eden Space]	Eden Space
[Monitor Heap Memory Rate] - [Survivor Space]	Survivor Space
[Monitor Heap Memory Rate] - [Tenured Gen]	Tenured Gen
[Monitor Non-Heap Memory Rate] - [Total Usage]	NON_HEAP
[Monitor Non-Heap Memory Rate] - [Code Cache]	Code Cache
[Monitor Non-Heap Memory Rate] - [Perm Gen]	Perm Gen
[Monitor Non-Heap Memory Rate] - [Perm Gen[shared-ro]]	Perm Gen [shared-ro]
[Monitor Non-Heap Memory Rate] - [Perm Gen[shared-rw]]	Perm Gen [shared-rw]

When “-XX:+UseParallelGC” and “-XX:+UseParallelOldGC” are specified as the startup options for the monitor target Java VM, the No. 3 Java memory pool name in the jramemory.stat log file will be as follows.

Monitor item	Character string output as memory_name
[Monitor Heap Memory Rate] - [Total Usage]	HEAP
[Monitor Heap Memory Rate] - [Eden Space]	PS Eden Space
[Monitor Heap Memory Rate] - [Survivor Space]	PS Survivor Space
[Monitor Heap Memory Rate] - [Tenured Gen]	PS Old Gen
[Monitor Non-Heap Memory Rate] - [Total Usage]	NON_HEAP
[Monitor Non-Heap Memory Rate] - [Code Cache]	Code Cache
[Monitor Non-Heap Memory Rate] - [Perm Gen]	PS Perm Gen
[Monitor Non-Heap Memory Rate] - [Perm Gen[shared-ro]]	Perm Gen [shared-ro]
[Monitor Non-Heap Memory Rate] - [Perm Gen[shared-rw]]	Perm Gen [shared-rw]

When “-XX:+UseConcMarkSweepGC” is specified as a startup option for the monitor target Java VM, the No. 3 Java memory pool name in the jramemory.stat log file will be as follows.

Monitor item	Character string output as memory_name
[Monitor Heap Memory Rate] - [Total Usage]	HEAP
[Monitor Heap Memory Rate] - [Eden Space]	Par Eden Space
[Monitor Heap Memory Rate] - [Survivor Space]	Par Survivor Space

[Monitor Heap Memory Rate] - [Tenured Gen]	CMS Old Gen
[Monitor Non-Heap Memory Rate] - [Total Usage]	NON_HEAP
[Monitor Non-Heap Memory Rate] - [Code Cache]	Code Cache
[Monitor Non-Heap Memory Rate] - [Perm Gen]	CMS Perm Gen
[Monitor Non-Heap Memory Rate] - [Perm Gen[shared-ro]]	Perm Gen [shared-ro]
[Monitor Non-Heap Memory Rate] - [Perm Gen[shared-rw]]	Perm Gen [shared-rw]

When [Oracle Java(usage monitoring)] is selected for [JVM Type] and "-XX:+UseSerialGC" is specified as a startup option for the monitor target Java VM, the No. 3 Java memory pool name in the jramemory.stat file will be as follows.

Monitor item	Character string output as memory_name
[Monitor Heap Memory Usage]-[Total Usage]	HEAP
[Monitor Heap Memory Usage]-[Eden Space]	Eden Space
[Monitor Heap Memory Usage]-[Survivor Space]	Survivor Space
[Monitor Heap Memory Usage]-[Tenured Gen]	Tenured Gen
[Monitor Non-Heap Memory Usage]-[Total Usage]	NON_HEAP
[Monitor Non-Heap Memory Usage]-[Code Cache]	Code Cache (For Java 9, no output)
[Monitor Non-Heap Memory Usage]-[Metaspace]	Metaspace

When [Oracle Java(usage monitoring)] is selected for [JVM Type] and "-XX:+UseParallelGC" and "-XX:+UseParallelOldGC" are specified as startup options for the monitor target Java VM, the No. 3 Java memory pool name in the jramemory.stat file will be as follows.

Monitor item	Character string output as memory_name
[Monitor Heap Memory Usage]-[Total Usage]	HEAP
[Monitor Heap Memory Usage]-[Eden Space]	PS Eden Space
[Monitor Heap Memory Usage]-[Survivor Space]	PS Survivor Space
[Monitor Heap Memory Usage]- [Tenured Gen]	PS Old Gen
[Monitor Non-Heap Memory Usage]-[Total Usage]	NON_HEAP
[Monitor Non-Heap Memory Usage]-[Code Cache]	Code Cache (For Java 9, no output)
[Monitor Non-Heap Memory Usage]-[Metaspace]	Metaspace

When [Oracle Java(usage monitoring)] is selected for [JVM Type] and "-XX:+UseConcMarkSweepGC" is specified as a startup option for the monitor target Java VM, the No. 3 Java memory pool name in the jramemory.stat file will be as follows.

Monitor item	Character string output as memory_name
[Monitor Heap Memory Usage]-[Total Usage]	HEAP
[Monitor Heap Memory Usage]-[Eden Space]	Par Eden Space
[Monitor Heap Memory Usage]-[Survivor	Par Survivor Space

[Space]	
[Monitor Heap Memory Usage]-[Tenured Gen]	CMS Old Gen
[Monitor Non-Heap Memory Usage]-[Total Usage]	NON_HEAP
[Monitor Non-Heap Memory Usage]-[Code Cache]	Code Cache (For Java 9, no output)
[Monitor Non-Heap Memory Usage]-[Metaspace]	Metaspace

When [Oracle Java(usage monitoring)] is selected for [JVM Type] and "-XX:+UseParNewGC" is specified as a startup option for the monitor target Java VM, the No. 3 Java memory pool name in the jramemory.stat file will be as follows. For Java 9, if -XX:+UseParNewGC is specified, the monitor target Java VM does not start.

Monitor item	Character string output as memory_name
[Monitor Heap Memory Usage]-[Total Usage]	HEAP
[Monitor Heap Memory Usage]-[Eden Space]	Par Eden Space
[Monitor Heap Memory Usage]-[Survivor Space]	Par Survivor Space
[Monitor Heap Memory Usage]-[Tenured Gen]	Tenured Gen
[Monitor Non-Heap Memory Usage]-[Total Usage]	NON_HEAP
[Monitor Non-Heap Memory Usage]-[Code Cache]	Code Cache
[Monitor Non-Heap Memory Usage]-[Metaspace]	Metaspace

When [Oracle Java(usage monitoring)] is selected for [JVM Type] and "-XX:+UseG1GC" is specified as a startup option for the monitor target Java VM the No. 3 Java memory pool name in the jramemory.stat file will be as follows.

Monitor item	Character string output as memory_name
[Monitor Heap Memory Usage]-[Total Usage]	HEAP
[Monitor Heap Memory Usage]-[Eden Space]	G1 Eden Space
[Monitor Heap Memory Usage]-[Survivor Space]	G1 Survivor Space
[Monitor Heap Memory Usage]-[Tenured Gen (Old Gen)]	G1 Old Gen
[Monitor Non-Heap Memory Usage]-[Total Usage]	NON_HEAP
[Monitor Non-Heap Memory Usage]-[Code Cache]	Code Cache (For Java 9, no output)
[Monitor Non-Heap Memory Usage]-[Metaspace]	Metaspace

When the monitor target Java VM is Oracle JRockit (when [JRockit] is selected for [JVM Type]), the No. 3 Java memory pool name in the jramemory.stat log file will be as follows.

Monitor item	Character string output as memory_name
[Monitor Heap Memory Rate] - [Total Usage]	HEAP memory
[Monitor Heap Memory Rate] - [Nursery Space]	Nursery
[Monitor Heap Memory Rate] - [Old Space]	Old Space
[Monitor Non-Heap Memory Rate] - [Total Usage]	NON_HEAP
[Monitor Non-Heap Memory Rate] - [Class]	Class Memory

Memory]	
---------	--

Java memory pool names appearing in the jramemory.stat log file, a JVM statistics log file, correspond to the Java VM memory space as follows.

◆ For Oracle Java 6/Oracle Java 7

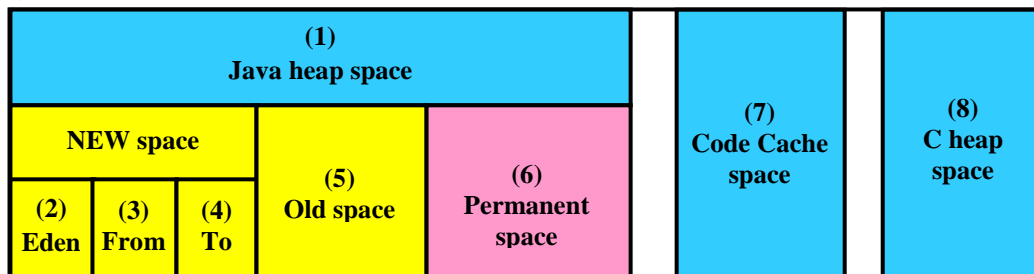

No. in diagram	Monitor item	Java memory pool name in jramemory.stat log file
(1)	[Monitor Heap Memory Rate] - [Total Usage]	HEAP
(2)	[Monitor Heap Memory Rate] - [Eden Space]	EdenSpace PS Eden Space Par Eden Space
(3)+(4)	[Monitor Heap Memory Rate] - [Survivor Space]	Survivor Space PS Survivor Space Par Survivor Space
(5)	[Monitor Heap Memory Rate] - [Tenured Gen]	Tenured Gen PS Old Gen CMS Old Gen
(6)	[Monitor Non-Heap Memory Rate] - [Perm Gen] [Monitor Non-Heap Memory Rate] - [Perm Gen[shared-ro]] [Monitor Non-Heap Memory Rate] - [Perm Gen[shared-rw]]	Perm Gen Perm Gen [shared-ro] Perm Gen [shared-rw] PS Perm Gen CMS Perm Gen
(7)	[Monitor Non-Heap Memory Rate] - [Code Cache]	Code Cache
(8)	-	-
(6)+(7)	[Monitor Non-Heap Memory Rate] - [Total Usage]	NON_HEAP * No stack trace is included.

◆ For Oracle Java 8/Oracle Java 9

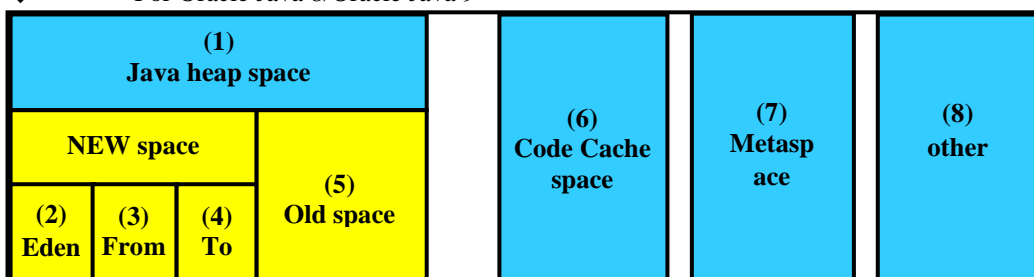

Number in diagram	Monitor item	Java memory pool name in jramemory.stat log file
(1)	[Monitor Heap Memory Usage] -	HEAP

	[Total Usage]	
(2)	[Monitor Heap Memory Usage] - [Eden Space]	EdenSpace PS Eden Space Par Eden Space G1 Eden Space
(3)+(4)	[Monitor Heap Memory Usage] - [Survivor Space]	Survivor Space PS Survivor Space Par Survivor Space G1 Survivor Space
(5)	[Monitor Heap Memory Usage] - [Tenured Gen]	Tenured Gen PS Old Gen CMS Old Gen G1 Old Gen
(6)	[Monitor Non-Heap Memory Usage] - [Code Cache]	Code Cache
(7)	[Monitor Non-Heap Memory Usage] - [Metaspace]	Metaspace
(8)	-	Compressed Class Space, etc.
(6)+(7) +(8)	[Monitor Non-Heap Memory Usage] - [Total Usage]	NON_HEAP

◆ For Oracle JRockit

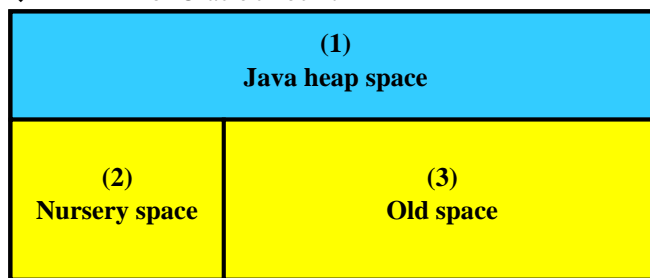

No. in diagram	Monitor item	Java memory pool name in jramemory.stat log file
(1)	[Monitor Heap Memory Rate] - [Total Usage]	HEAP memory
(2)	[Monitor Heap Memory Rate] - [Nursery Space]	Nursery
(3) (Note)	[Monitor Heap Memory Rate] - [Old Space]	Old Space
-	[Monitor Non-Heap Memory Rate] - [Total Usage]	NON_HEAP
-	[Monitor Non-Heap Memory Rate] - [Class Memory]	Class Memory

(Note)

“Old Space”, a Java memory pool name in the jramemory.stat log file, does not indicate the value corresponding to the old space of the Heap but rather the value corresponding to the entire “Heap memory”. Independent measurement of only (3) is not possible.

## Executing a command corresponding to cause of each detected error

EXPRESSCLUSTER does not provide a means for executing specific commands based on the causes of detected monitor resource errors.

JVM monitor resources can execute specific commands according to error causes. If an error is



detected, JVM monitor resources will execute an appropriate command.

The following setting items specify the commands that will be executed according to the error cause.

Error cause	Setting item
<ul style="list-style-type: none"> <li>Failure in connection to the monitor target Java VM</li> <li>Failure in resource measurement</li> </ul>	[Monitor(special)] tab - [Command]
<ul style="list-style-type: none"> <li>Heap memory rate</li> <li>Non-heap memory rate</li> <li>Virtual memory usage</li> <li>Heap memory usage</li> <li>Non-heap memory usage</li> </ul>	[Monitor(special)] tab - [Tuning] properties - [Memory] tab - [Command]
<ul style="list-style-type: none"> <li>Number of active threads</li> </ul>	[Monitor(special)] tab - [Tuning] properties - [Thread] tab - [Command]
<ul style="list-style-type: none"> <li>Time in Full GC</li> <li>Count of Full GC execution</li> </ul>	[Monitor(special)] tab - [Tuning] properties - [GC] tab - [Command]
<ul style="list-style-type: none"> <li>Requests in Work Manager of WebLogic</li> <li>Requests in Thread Pool of WebLogic</li> </ul>	[Monitor(special)] tab - [Tuning] properties - [WebLogic] tab - [Command]

[Command] passes the details of an error cause as the arguments of a command with the arguments attached to the end of [Command]. A Command that is specialized for dealing with specific error causes can be defined by designing and specifying a script etc. for [Command]. The following character strings are passed as the arguments.

When multiple character strings are stated as possible arguments, one will be passed according to the GC type of the monitor target Java VM. For details about their differences, see “Java memory pool name”.

The statements “(For Oracle Java)” and “(For Oracle JRockit)” suggest that different character strings are used according to the JVM type. When there is no such statement, the same character strings are used equally for all JVM types.

Details of error causes	Character string passed as argument
<ul style="list-style-type: none"> <li>Failure in connection to the monitor target Java VM</li> <li>Failure in resource measurement</li> </ul>	No character string defined
[Monitor(special)] tab - [Tuning] properties - [Memory] tab - [Monitor Memory Heap Rate] - [Total Usage] (For Oracle Java)	HEAP
[Memory] tab - [Monitor Memory Heap Rate] - [Eden Space] (For Oracle Java)	EdenSpace PSEdenSpace ParEdenSpace
[Memory] tab - [Monitor Memory Heap Rate] - [Survivor Space] (For Oracle Java)	SurvivorSpace PSSurvivorSpace ParSurvivorSpace
[Memory] tab - [Monitor Memory Heap Rate] - [Tenured Gen] (For Oracle Java)	TenuredGen PSOldGen CMSOldGen
[Memory] tab - [Monitor Non-Heap Memory Rate] - [Total Usage] (For Oracle Java)	NON_HEAP
[Memory] tab - [Monitor Memory Non-Heap Rate] -	CodeCache

[Code Cache] (For Oracle Java)	
[Memory] tab - [Monitor Memory Non-Heap Rate] - [Perm Gen] (For Oracle Java)	PermGen PSPermGen CMSPermGen
[Memory] tab - [Monitor Memory Non-Heap Rate] - [Perm Gen[shared-ro]] (For Oracle Java)	PermGen[shared-ro]
[Memory] tab - [Monitor Memory Non-Heap Rate] - [Perm Gen[shared-rw]] (For Oracle Java)	PermGen[shared-rw]
[Memory] tab - [Monitor Virtual Memory Usage] - (For Oracle Java)	Vmsize
[Memory] tab - [Monitor Heap Memory Usage] - [Total Usage] (for Oracle Java(usage monitoring))	HEAP
[Memory] tab - [Monitor Heap Memory Usage] - [Eden Space] (for Oracle Java(usage monitoring))	EdenSpace PSEdenSpace ParEdenSpace G1EdenSpace
[Memory] tab - [Monitor Heap Memory Usage]- [Survivor Space] (for Oracle Java(usage monitoring))	SurvivorSpace PSSurvivorSpace ParSurvivorSpace G1SurvivorSpace
[Memory] tab - [Monitor Heap Memory Usage] - [Tenured Gen] (for Oracle Java(usage monitoring))	TenuredGen PSOldGen CMSOldGen G1OldGen
[Memory] tab - [Monitor Non-Heap Memory Usage] - [Total Usage] (for Oracle Java(usage monitoring))	NON_HEAP
[Memory] tab - [Monitor Non-Heap Memory Usage] - [Code Cache] (for Oracle Java(usage monitoring))	CodeCache
[Memory] tab - [Monitor Non-Heap Memory Usage] - [Metaspace] (for Oracle Java(usage monitoring))	Metaspace
[Memory] tab - [Monitor Memory Heap Rate] - [Total Usage] (For Oracle JRockit)	HEAP Heap
[Memory] tab - [Monitor Memory Heap Rate] - [Nursery Space] (For Oracle JRockit)	Nursery
[Memory] tab - [Monitor Memory Heap Rate] - [Old Space] (For Oracle JRockit)	OldSpace
[Memory] tab - [Monitor Memory Non-Heap Rate] - [Total Usage] (For Oracle JRockit)	NON_HEAP
[Memory] tab - [Monitor Memory Non-Heap Rate] - [Class Memory] (For Oracle JRockit)	ClassMemory
[Memory] tab - [Monitor Virtual Memory Usage] - (For Oracle JRockit)	Vmsize
[Thread] tab - [Monitor the number of Active Threads]	Count
[GC] tab - [Monitor the time in Full GC]	Time
[GC] tab - [Monitor the count of Full GC execution]	Count
[WebLogic] tab - [Monitor the requests in Work Manager] - [Waiting Requests, The number]	WorkManager_PendingRequests
[WebLogic] tab - [Monitor the requests in Thread	ThreadPool_PendingUserRequestCou

Pool] - [Waiting Requests, The number]	nt
[WebLogic] tab - [Monitor the requests in Thread Pool] - [Executing Requests, The number]	ThreadPool_Throughput

The following are examples of execution.

Example 1)

Setting item	Setting information
[Monitor(special)] tab - [Tuning] properties - [GC] tab - [Command]	/usr/local/bin/downcmd
[Monitor(special)] tab - [Tuning] properties - [GC] tab - [Monitor the count of Full GC execution]	1
[Cluster] properties - [JVM monitor] tab - [Resource Measurement Setting] - [Common] tab - [Error Threshold]	3

If Full GC is executed as many times, in succession, as specified by the Error Threshold (three times), the JVM monitor resources will detect a monitor error and execute a command corresponding to “/usr/local/bin/downcmd Cont”.

Example 2)

Setting item	Setting information
[Monitor(special)] tab - [Tuning] properties - [GC] tab - [Command]	“/usr/local/bin/downcmd” GC
[Monitor(special)] tab - [Tuning] properties - [GC] tab - [Monitor the time in Full GC]	65536
[Cluster] properties - [JVM monitor] tab - [Resource Measurement Setting] - [Common] tab - [Error Threshold]	3

If the time in Full GC exceeds 65535 milliseconds as many times, in succession, as specified by the Error Threshold (three times), the JVM monitor resources will detect a monitor error and execute a command corresponding to “/usr/local/bin/downcmd GC Time”.

Example 3)

Setting item	Setting information
[Monitor(special)] tab - [Tuning] properties - [Memory] tab - [Command]	“/usr/local/bin/downcmd” memory
[Monitor(special)] tab - [Tuning] properties - [Memory] tab - [Monitor Heap Memory Rate]	On
[Monitor(special)] tab - [Tuning] properties - [Memory] tab - [Eden Space]	80
[Monitor(special)] tab - [Tuning] properties - [Memory] tab - [Survivor Space]	80
[Cluster] properties - [JVM monitor] tab - [Resource Measurement Setting] - [Common] tab - [Error Threshold]	3

If the usage rate of the Java Eden Space and that of the Java Survivor Space exceed 80% as many times, in succession, as specified by the Error Threshold (three times), the JVM monitor resources will detect a monitor error and execute a command corresponding to “/usr/local/bin/downcmd memory EdenSpace SurvivorSpace”.

Timeout (seconds) for waiting for the completion of execution of the command specified by [Command] is set by specifying [Command Timeout] in the [JVM monitor] tab of the Cluster Properties window. The same value is applied to the timeout of [Command] of each of the above-mentioned tabs; the timeout cannot be specified for each [Command] separately.

If a timeout occurs, the system will not perform processing for forced termination of the [Command] process; the operator must perform post-processing (e.g. forced termination) of the [Command] process. When a timeout occurs, the following message is output to the JVM operation log:

action thread execution did not finish. action is alive = <command>.

Note the following.

- No [Command] is executed when restoration of the Java VM to normal operation (error → normal operation) is detected.
- [Command] is executed upon the detection of an error in the Java VM (when threshold exceeding occurs as many times, in succession, as specified by the error threshold). It is not executed at each threshold exceeding.
- Note that specifying [Command] on multiple tabs allows multiple commands to be executed if multiple errors occur simultaneously, causing a large system load.
- [Command] may be executed twice simultaneously when the following two items are monitored: [Monitor(special)] tab - [Tuning] properties - [WebLogic] tab - [Monitor the requests in Work Manager] - [Waiting Requests, The Number]; [Monitor(special)] tab - [Tuning] properties - [WebLogic] tab - [Monitor the requests in Work Manager] - [Waiting Requests, Average].

This is because errors may be detected simultaneously for the following two items: [Cluster] properties - [JVM monitor] tab - [Resource Measurement Setting] - [WebLogic] tab - [Interval, The number of request]; [Cluster] properties - [JVM monitor] tab - [Resource Measurement Setting] - [WebLogic] tab - [Interval, The average number of the request]. To prevent this from occurring, specify only one of the two items as a monitor target. This applies to the following combinations of monitor items.

- [Monitor(special)] tab - [Tuning] properties - [WebLogic] tab - [Monitor the requests in Thread Pool] - [Waiting Requests, The Number] and [Monitor(special)] tab - [Tuning] properties - [WebLogic] tab - [Monitor the requests in Thread Pool] - [Waiting Requests, Average]
- [Monitor(special)] tab - [Tuning] properties - [WebLogic] tab - [Monitor the requests in Thread Pool] - [Executing Requests, The Number] and [Monitor(special)] tab - [Tuning] properties - [WebLogic] tab - [Monitor the requests in Thread Pool] - [Executing Requests, Average]

## Monitoring WebLogic Server

For how to start the operation of the configured target WebLogic Server as an application server, see the manual for WebLogic Server.

This section describes only the settings required for monitoring by the JVM monitor resource.

1. Start WebLogic Server Administration Console.

For how to start WebLogic Server Administration Console, refer to “Overview of Administration Console” in the WebLogic Server manual.

Select **Domain Configuration-Domain-Configuration-General**. Make sure that **Enable Management Port** is unchecked.

2. Select **Domain Configuration-Server**, and then select the name of the server to be monitored. Set the selected server name as the identifier on the **Monitor(special)** tab from **Properties** that can be selected in the Builder tree view. See “Understanding JVM monitor resources”.
3. Regarding the target server, select **Configuration-General**, and then check the port number through which a management connection is established with **Listen Port**.
4. Stop WebLogic Server. For how to stop WebLogic Server, refer to “Starting and stopping WebLogic Server” in the WebLogic Server manual.
5. Start the management server start script of WebLogic Server (startWebLogic.sh).
6. Write the following instructions in the script.

➤ When the target is the WebLogic Server managing server:

```
✓ JAVA_OPTIONS="${JAVA_OPTIONS}
-Dcom.sun.management.jmxremote.port=n
-Dcom.sun.management.jmxremote.ssl=false
-Dcom.sun.management.jmxremote.authenticate=false"
```

\*Write each line of coding on one line.

➤ When the target is a WebLogic Server managed server:

```
✓ if [ "${SERVER_NAME}" = "SERVER_NAME" ]; then
  JAVA_OPTIONS="${JAVA_OPTIONS}
-Dcom.sun.management.jmxremote.port=n
-Dcom.sun.management.jmxremote.ssl=false
-Dcom.sun.management.jmxremote.authenticate=false"
```

\*Write all the if statement lines (lines 2 to 5) on one line.

---

### Note:

For *n*, specify the number of the port used for monitoring. The specified port number **must be different from that of the listen port for the target Java VM**. If there are other target WebLogic Server entities on the same machine, specify a port number different from those for the listening port and application ports of the other entities.

---

**Note:**

For *SERVER\_NAME*, specify the name of the target server confirmed by **Select Target Server**. If more than one server is targeted, change the server name on the settings (line 1 to 6) for each server.

---

**Note:**

When the target is WebLogic Server 11gR1(10.3.3) or later, add the following options:

```
-Djavax.management.builder.initial=weblogic.management.jmx.  
mbeanserver.WLSMBeanServerBuilder
```

---

**Note:**

Place the above addition prior to the following coding:

```
${JAVA_HOME}/bin/java ${JAVA_VM} ${MEM_ARGS} ${JAVA_OPTIONS}  
-Dweblogic.Name=${SERVER_NAME}  
-Djava.security.policy=${WL_HOME}/server/lib/weblogic.policy  
${PROXY_SETTINGS} ${SERVER_CLASS}
```

\*Write the above coding on one line.

\* The above java arguments differ depending on the WebLogic version. There is no problem by specifying JAVA\_OPTIONS before using java.

---

**Note:**

For monitoring **Perm Gen[shared-ro]** or **Perm Gen[shared-rw]** on the **Memory** tab, add the following line:

```
-client -Xshare:on -XX:+UseSerialGC
```

---

7. Redirect the standard output and standard error output of the target WebLogic Server to a file. For how to configure these settings, refer to the WebLogic Server manual. Configure the settings if you want to include the standard output and standard error output in information to be collected. When configuring the settings, be careful to secure sufficient hard disk space.
8. Configure the settings so as to output the GC log to the target WebLogic Server. For how to configure these settings, refer to the WebLogic Server manual. Configure the settings if you want to include the GC log in information to be collected. When configuring the settings, be careful to secure sufficient hard disk space.

9. Make the following settings.

Start WLST (wlst.sh) of the target WebLogic Server. On the console window displayed, execute the following commands:

```
>connect(' USERNAME' , ' PASSWORD' , ' t3://SERVER_ADDRESS:SERVER_PORT' )
> edit()
> startEdit()
> cd(' JMX/DOMAIN_NAME' )
> set(' PlatformMBeanServerUsed' , ' true' )
> activate()
> exit()
```

Replace the **USERNAME**, **PASSWORD**, **SERVER\_ADDRESS**, **SERVER\_PORT**, and **DOMAIN\_NAME** above with those for the domain environment.

10. Restart the target WebLogic Server.

## Monitoring WebOTX

This section describes how to configure a target WebOTX to enable monitoring by the JVM monitor resource.

Start the WebOTX Administration Console. For how to start the WebOTX Administration Console, refer to “Starting and stopping administration tool” in the *WebOTX Operation (Web Administration Tool)*.

The settings differ depending on whether a Java process of the JMX agent running on WebOTX or the Java process of a process group is to be monitored. Configure the settings according to the target of monitoring.

## Monitoring a Java process of the WebOTX domain agent

There is no need to specify any settings. If you are using V8.30, please upgrade to V8.31 or later.

## Monitoring a Java process of a WebOTX process group

1. Connect to the domain by using the administration tool.
2. In the tree view, select **<domain\_name>-TP System-Application Group-<application\_group\_name>-Process Group-<process\_group\_name>**.
3. For the **Other Arguments** attributes on the **JVM Options** tab on the right, specify the following Java options on one line. For *n*, specify the port number. If there is more than one Java VM to be monitored on the same machine, specify a unique port number. The port number specified for the settings is specified with Builder (table view → **JVM Monitor Resource Name** → **Property** → **Monitor(special)** tab → **Connection Port**).
 

```
-Dcom.sun.management.jmxremote.port=n
-Dcom.sun.management.jmxremote.ssl=false
-Dcom.sun.management.jmxremote.authenticate=false
-Djavax.management.builder.initial=com.nec.webotx.jmx.mbeanserver.JmxMBeanServerBuilder
```

\* In the case of WebOTX V9.2 or later, it is unnecessary to specify `-Djavax.management.builder.initial`.

4. Then, click **Update**. After the configuration is completed, restart the process group.

These settings can be made by using **Java System Properties**, accessible from the **Java System Properties** tab of the WebOTX administration tool. When making these settings by using the tool, do not designate `-D` and set the strings prior to `=` in name and set the strings subsequent to `=` in value.

---

### Note:

If restart upon a process failure is configured as a function of the WebOTX process group, and when the process group is restarted as the recovery processing by EXPRESSCLUSTER, the WebOTX process group may fail to function correctly. For this reason, when monitoring the WebOTX process group, make the following settings for the JVM monitor resource by using the Builder.

---

Tab name for setting	Item name	Setting value
Monitor(common)	Monitor Timing	Always
Recovery Action	Recovery Action	Execute only the final action
Recovery Action	Final Action	No operation

Linking with the load balancer is not supported for WebOTX process group monitoring.

---



## Receiving WebOTX notifications

By registering a specific listener class, notification is issued when WebOTX detects a failure. The JVM monitor resource receives the notification and outputs the following message to the JVM operation log.

```
%1$s:Notification received. %2$s.
```

%1\$s and %2\$s each indicates the following:

```
%1$s: Monitored Java VM
```

```
%2$s: Message in the notification (ObjectName=**,type=**,message=**)
```

At present, the following is the detailed information on MBean on the monitorable resource.

ObjectName	[domainname];j2eeType=J2EEDomain,name=[domainname],category=runtime
notification type	nec.webotx.monitor.alivecheck.not-alive
Message	failed

## Monitoring JBoss

JBoss Enterprise Application Platform 6 and later versions support two management modes, namely, standalone mode and domain mode. When monitoring JBoss with the JVM monitor resources, the following three cases must be handled separately and in different ways.

- JBoss Enterprise Application Platform 5 or earlier
- Standalone mode of JBoss Enterprise Application Platform 6
- Domain mode of JBoss Enterprise Application Platform 6

This section describes how to configure a target JBoss to be monitored by the JVM monitor resource.

JBoss Enterprise Application Platform 5 or earlier

1. Stop JBoss, and then open (*JBoss\_installation\_path*)/bin/run.conf by using editor software.
2. In the configuration file, specify the following settings on one line. For *n*, specify the port number. If there is more than one Java VM to be monitored on the same machine, specify a unique port number. The port number specified for the settings is specified with Builder (table view → **JVM Monitor Resource Name** → **Property** → **Monitor(special)** tab → **Connection Port**).

```
JAVA_OPTS="${JAVA_OPTS}
- Dcom.sun.management.jmxremote.port=n
- Dcom.sun.management.jmxremote.ssl=false
- Dcom.sun.management.jmxremote.authenticate=false"
```

3. Save the settings, and then start JBoss.
4. With Builder (table view → **JVM Monitor Resource Name** → **Property** → **Monitor(special)** tab → **Identifier**), specify a unique string that is different from those for the other monitor targets (e.g., JBoss). With Builder (table view → **JVM Monitor Resource Name** → **Property** → **Monitor(special)** tab → **Process Name**), set [com.sun.management.jmxremote.port=*n*] (*n* is the port number specified in 2).

## Standalone mode of JBoss Enterprise Application Platform 6

1. Stop JBoss, and then open (*JBoss\_installation\_path*)/bin/standalone.conf by using editor software.
2. In the configuration file, specify the following settings. For *n*, specify the port number. If there is more than one Java VM to be monitored on the same machine, specify a unique port number. The port number specified for the settings is specified with Builder (table view → JVM Monitor Resource Name → Property → Monitor(special) tab → Connection Port).

Add the following before “if [ "x\$JBASS\_MODULES\_SYSTEM\_PKGS" = "x" ]; then”.

```
JBASS_MODULES_SYSTEM_PKGS="org.jboss.logmanager"
```

Add the following after “if [ "x\$JAVA\_OPTS" = "x" ]; then ... fi:”.

```
JAVA_OPTS="$JAVA_OPTS  
-Xbootclasspath/p:$JBASS_HOME/modules/org/jboss/logmanager/main/jboss-log  
manager-1.3.2.Final-redhat-1.jar"  
JAVA_OPTS="$JAVA_OPTS  
-Djava.util.logging.manager=org.jboss.logmanager.LogManager"  
JAVA_OPTS="$JAVA_OPTS -Dcom.sun.management.jmxremote.port=n  
-Dcom.sun.management.jmxremote.ssl=false  
-Dcom.sun.management.jmxremote.authenticate=false"
```

\* The storage directory and file name of jboss-logmanager-\*.jar differ depending on the JBoss version. Therefore, specify the path according to the installation environment.

3. Save the settings, and then start JBoss.
4. With Builder (table view → JVM Monitor Resource Name → [Property] → [Monitor(special)] tab → Identifier), specify a unique string that is different from those for the other monitor targets (e.g. JBoss). With Builder (table view → JVM Monitor Resource Name → [Property] → [Monitor(special)] tab → Process Name), set “com.sun.management.jmxremote.port=*n*” (*n* is the port number specified in 2).

## Domain mode of JBoss Enterprise Application Platform 6

1. With Builder (table view → JVM Monitor Resource Name → [Property] → [Monitor(special)] tab → Identifier), specify a unique string that is different from those for the other monitor targets (e.g. JBoss). With Builder (table view → JVM Monitor Resource Name → [Property] → [Monitor(special)] tab → Process Name), specify all the Java VM startup options so that JBoss can be uniquely identified.

## Monitoring Tomcat

This section describes how to configure a target Tomcat to be monitored by the JVM monitor resource.

1. Stop Tomcat, and then open (*Tomcat\_installation\_path*)/bin/catalina.sh by using editor software. If Tomcat is installed from rpm package, open /etc/sysconfig/tomcat6 or /etc/sysconfig/tomcat.
2. In the configuration file, for the Java options, specify the following settings on one line. For *n*, specify the port number. If there is more than one Java VM to be monitored on the same machine, specify a unique port number. The port number specified for the settings is specified with Builder (table view → **JVM Monitor Resource Name** → **Property** → **Monitor(special)** tab → **Connection Port**).  
**CATALINA\_OPTS**="{CATALINA\_OPTS}  
-Dcom.sun.management.jmxremote.port=*n*  
-Dcom.sun.management.jmxremote.ssl=false  
-Dcom.sun.management.jmxremote.authenticate=false"

---

### Note:

If edit file is catalina.sh, write the above addition prior to the following coding.

```
if [ "$1" = "debug" ] ; then
    if $os400; then
        echo "Debug command not available on OS400"
        exit 1
    else
```

---

3. Save the settings, and then start Tomcat.
4. With Builder (table view → **JVM Monitor Resource Name** → **Property** → **Monitor(special)** tab → **Identifier**), specify a unique string that is different from those for the other monitor targets (e.g., tomcat). With Builder (table view → **JVM Monitor Resource Name** → **Property** → **Monitor (special)** tab → **Process Name**), set "com.sun.management.jmxremote.port=*n*" (*n* is the port number specified in 2).

## Monitoring SVF

This section describes how to configure a target SVF to be monitored by the JVM monitor resource.

1. Select a monitor target from the following, and then use an editor to open the corresponding script.

Monitor target	Script to be edited
Simple Httpd Service (for 8.x)	<SVF installation path>/bin/SimpleHttpd
Simple Httpd Service (for 9.x)	<SVF installation path>/bin/UCXServer
RDE Service	<SVF installation path>/rdjava/rdserver/rd_server_startup.sh
	<SVF installation path>/rdjava/rdserver/svf_server_startup.sh
RD Spool Balancer	<SVF installation path>/rdjava/rdbalancer/rd_balancer_startup.sh
Tomcat (for 8.x)	<SVF installation path>/rdjava/apache-tomcat-5.5.25/bin/catalina.sh
Tomcat (for 9.x)	<SVF installation path>/apache-tomcat/bin/catalina.sh
SVF Print Spooler Service	<SVF installation path>/bin/spooler

2. In the configuration file, for the Java options, specify the following settings on one line. For *n*, specify the port number. If there is more than one Java VM to be monitored on the same machine, specify a unique port number. The port number specified here is also specified with the Builder (table view → **JVM Monitor Resource Name** → **Property** → **Monitor(special)** tab → **Connection Port**).

```
JAVA_OPTIONS="${JAVA_OPTIONS}
-Dcom.sun.management.jmxremote.port=n
-Dcom.sun.management.jmxremote.ssl=false
-Dcom.sun.management.jmxremote.authenticate=false
```

3. If the monitor target is RDE Service, add `${JAVA_OPTIONS}` into the following startup path and `rd_balancer_startup.sh`

```
java -Xmx256m -Xms256m -Djava.awt.headless=true ${JAVA_OPTIONS}
-classpath $CLASSPATH jp.co.fit.vfreport.RdSpoolPlayerServer &
```

4. With the Builder (table view → **JVM Monitor Resource Name** → **Property** → **Monitor(special)** tab → **Identifier**), and with the Builder (table view → **JVM Monitor Resource Name** → **Property** → **Monito (special)** tab → **Process Name**), specify the following.

Monitor target	Identifier, Process Name
Simple Httpd Service	SimpleHttpd
RDE Service	ReportDirectorServer
	RdSpoolPlayerServer
RD Spool Balancer	ReportDirectorSpoolBalancer
Tomcat (for 8.x)	Bootstrap
Tomcat (for 9.x)	-Dcom.sun.management.jmxremote.port= <i>n</i>
SVF Print Spooler Service	spooler.Daemon

## Monitoring iPlanet Web Server

This section describes how to configure a target iPlanet Web Server to be monitored by the JVM monitor resource.

1. Stop the iPlanet Web Server, and then, using an editor, open (iPlanet Web Server installation path)/(monitored server name)/config/server.xml.
2. In /server/jvm/jvm-options, specify the following settings on one line. For *n*, specify the port number. If there is more than one Java VM to be monitored on the same machine, specify a unique port number. The port number specified here is also specified with the Builder (table view → **JVM Monitor Resource Name** → **Property** → **Monitor(special)** tab → **Connection Port**).  

```
<java-options> -Dcom.sun.management.jmxremote.port=n  
-Dcom.sun.management.jmxremote.ssl=false  
-Dcom.sun.management.jmxremote.authenticate=false
```
3. Save the settings, and then start the iPlanet Web Server.

## Displaying and changing the JVM monitor resource details

1. Click the **Monitors** icon on the tree view displayed on the left side of the Builder window.
2. A list of the monitor resources is displayed in the table view on the right side of the screen. Right-click the target JVM monitor resource, and click the **Parameter** tab in the **Monitor Resource Property** window.
3. On the **Parameter** tab, you can see and/or change the detailed settings as described below.

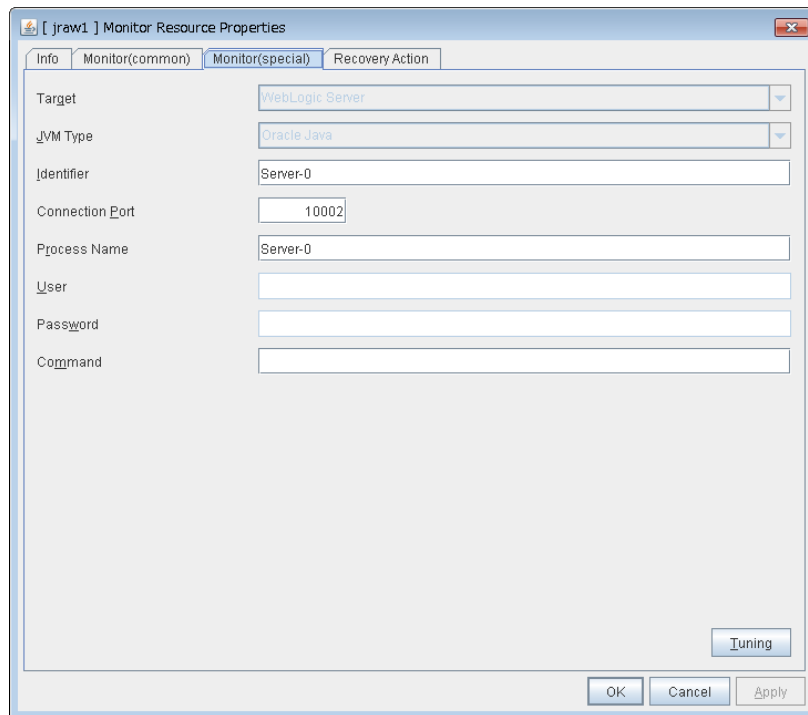

### Target

Select the target to be monitored from the list. When monitoring WebSAM SVF for PDF, WebSAM Report Director Enterprise, or WevSAM Universal Connect/X, select **WebSAM SVF**. When monitoring a Java application that you created, select **Java Application**.

Select [JBoss] when monitoring JBoss Enterprise Application Platform 5 or earlier, or when monitoring standalone mode of JBoss Enterprise Application Platform 6 or standalone mode of a later version. Select "JBoss Domain Mode" when monitoring the domain mode of JBoss Enterprise Application Platform 6 or the domain mode of a later version.

Default: None

### JVM Type

Select the Java VM on which the target application to be monitored is running.

For Java 8 or later, select **Oracle Java(usage monitoring)**. For Java 8, the following specification changes have been made.

- ◆ It has become impossible to acquire the maximum value of each memory in a non-heap area.
- ◆ Perm Gen has been changed to Metaspace.

For Java 8, therefore, the monitor items on the **Memory** tab have been changed as below.

- ◆ Monitoring for the use rate has been changed to monitoring for the amount used.
- ◆ **Perm Gen, Perm Gen[shared-ro], and Perm Gen[shared-rw]** cannot be monitored. Clear the check box.
- ◆ **Metaspace** can be monitored.

For Java 9, the following specification changes have been made.

- ◆ **Code Cache** has been divided.

For Java9, therefore, the monitor items on the **Memory** tab have been changed as below.

- ◆ **Code Cache** cannot be monitored. Clear the check box.

For each monitor target, the following are selectable.

- ◆ When the target is **WebLogic Server**  
**Oracle Java, Oracle Java(usage monitoring), and Oracle JRockit** are selectable
- ◆ When the target is **Tomcat**  
**Oracle Java, Oracle Java(usage monitoring), and OpenJDK** are selectable.
- ◆ When the target is other than **WebLogic Server** and **Tomcat**  
**Oracle Java** and **Oracle Java(usage monitoring)** are selectable.

Default: None

#### **Identifier** (within 255 bytes)

The identifier is set to differentiate the relevant JVM monitor resource from another JVM monitor resource when the information on the application to be monitored is output to the JVM operation log of the relevant JVM monitor resource. For this purpose, set a unique character string between JVM monitor resources. You must specify the identifier.

- ◆ When the target is **WebLogic Server**  
Set the name of the server instance to be monitored, according to “Monitoring WebLogic Server”, item 2.
- ◆ When the target is **WebOTX Process Group**  
Specify the name of the process group.
- ◆ When the target is **WebOTX Domain Agent**  
Specify the name of the domain.
- ◆ When the target is **JBoss or JBoss Domain Mode**  
Specify this according to “Monitoring JBoss”.
- ◆ When the target is **Tomcat**  
Specify this according to “Monitoring Tomcat”.
- ◆ When the target is **WebOTX ESB**  
Same as for **WebOTX Process Group**.
- ◆ When the target is **WebSAM SVF**  
Specify this according to “Monitoring SVF”.
- ◆ When the target is **iPlanet Web Server**  
Specify this according to “Monitoring iPlanet Web Server”.
- ◆ When the target is **Java Application**  
Specify a uniquely identifiable string for the monitored Java VM process.

Default: None

**Connection Port** (1024 to 65535)

Set the port number used by the JVM monitor resource when it establishes a JMX connection to the target Java VM. The JVM monitor resource obtains information by establishing a JMX connection to the target Java VM. Therefore, to register the JVM monitor resource, it is necessary to specify the setting by which the JMX connection port is opened for the target Java VM. You must specify the connection port. This is common to all the servers in the cluster. A value between 42424 and 61000 is not recommended.

- ◆ When the target is **WebLogic Server**  
Set the connection port number according to “Monitoring WebLogic Server”, item 6.
- ◆ When the target is **WebOTX Process Group**  
Specify this according to “Monitoring a Java process of a WebOTX process group”.
- ◆ When the target is **WebOTX Domain Agent**  
Specify “domain.admin.port” of  
“(WebOTX\_installation\_path)/<domain\_name>.properties”.
- ◆ When the target is **JBoss**  
Specify as described in “Monitoring JBoss”.
- ◆ When the target is **JBoss Domain Mode**  
The connection port number need not be specified.
- ◆ When the target is **Tomcat**  
Specify as described in “Monitoring Tomcat”.
- ◆ When the target is **WebOTX ESB**  
Same as for **WebOTX Process Group**.
- ◆ When the target is **WebSAM SVF**  
Specify this according to “Monitoring SVF”.
- ◆ When the target is **iPlanet Web Server**  
Specify this according to “Monitoring iPlanet Web Server”.
- ◆ When the target is **Java Application**  
Specify a uniquely identifiable string for the monitored Java VM process.

Default: None

**Process Name** (within 1024 bytes)

Set a **Process Name** to identify the target JVM monitor resource when outputting information of the monitor target to the JVM operation log of the JVM monitor resource. Therefore, be sure to specify a character string that is unique among JVM monitor resources.

- ◆ When the target is **WebLogic Server**  
Specify a unique server instance name for a process name to identify the target Java VM process. If the process name consisting of only a server instance name is not unique, specify a process name by combining a server instance name and **Connection Port** number.  
Example: When the server instance name is ServerA and the **Connection Port** number is 7001, the **Process Name** is ServerA7001.
- ◆ When the target is other than **WebOTX Process Group**  
Specify the name of the process group. If you are specifying multiple settings, specify a string that can be uniquely identified across the group process so that no name is specified more than the same process group.
- ◆ When the target is **WebOTX Domain Agent**  
Specify “-Dwebotx.funcid=agent -Ddomain.name=<domain\_name>”.
- ◆ When the target is **JBoss or JBoss domain mode**  
Specify this according to “Monitoring JBoss”.



- ◆ When the target is **Tomcat**  
Specify this according to “Monitoring Tomcat”.
- ◆ When the target is **WebOTX ESB**  
Same as for **WebOTX Process Group**.
- ◆ When the target is **WebSAM SVF**  
Specify this according to “Monitoring SVF”.
- ◆ When the target is **iPlanet Web Server**  
Specify this according to “Monitoring iPlanet Web Server”.
- ◆ When the target is **Java Application**  
Specify a uniquely identifiable string for the monitored Java VM process.

Default: None

#### User (within 255 bytes)

Specify the name of the administrator who will be making a connection with the target Java VM.

- ◆ When **WebOTX Domain Agent** is selected as the target  
Specify the “domain.admin.user” value of “/opt/WebOTX/<domain\_name>.properties”.
- ◆ When the target is other than **WebOTX Domain Agent**  
This cannot be specified.

Default: None

#### Password (within 255 bytes)

Specify the password for the administrator who will be making a connection with the target Java VM.

- ◆ When **WebOTX Domain Agent** is selected as the target  
Specify the “domain.admin.passwd” value of “/opt/WebOTX/<domain\_name>.properties”.
- ◆ When the target is other than **WebOTX Domain Agent**  
This cannot be specified.

Default: None

#### Command (within 255 bytes)

Specify the commands that will be executed if errors in the monitor target Java VM are detected. A specific command and argument(s) can be specified for each error cause. Use an absolute path to specify each command. Place the executable file name in double quotes (“”) to specify it.

Example) “/usr/local/bin/command” arg1 arg2

Specify the commands that will be executed if connection to the monitor target Java VM cannot be established or if an error is detected in the process for acquiring the amount of resource usage on the Java VM.

See “Executing a command corresponding to cause of each detected error”.

Default: None

When you click **Tuning**, the following information is displayed in the pop-up dialog box. Make detailed settings according to the descriptions below.

## Memory tab (when Oracle Java or OpenJDK is selected for JVM Type)

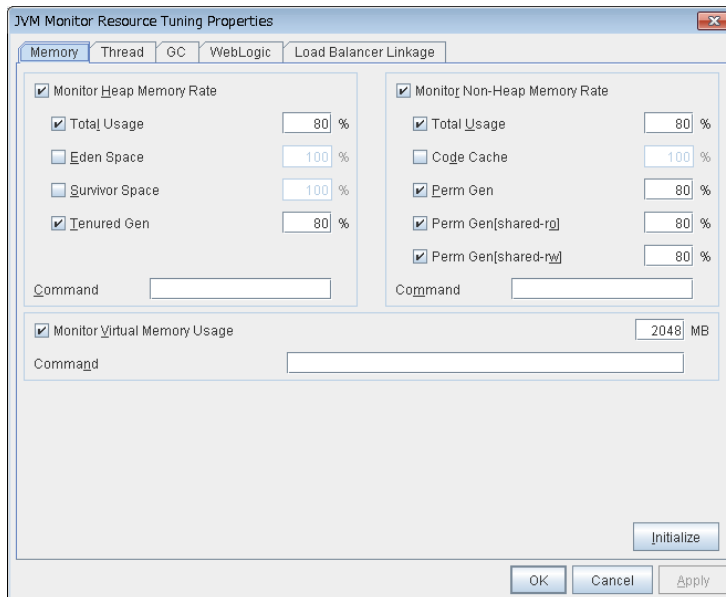

### Monitor Heap Memory Rate

Enables the monitoring of the usage rates of the Java heap areas used by the target Java VM.

- ◆ When the check box is selected (default):  
Monitoring enabled
- ◆ When the check box is not selected:  
Monitoring disabled

### Total Usage (1 to 100)

Specify the threshold for the usage rate of the Java heap areas used by the target Java VM.

Default: 80[%]

### Eden Space (1 to 100)

Specify the threshold for the usage rate of the Java Eden Space used by the target Java VM. If G1 GC is specified as the GC method, read it as G1 Eden Space.

Default: 100[%]

### Survivor Space (1 to 100)

Specify the threshold for the usage rate of the Java Survivor Space used by the target Java VM. If G1 GC is specified as the GC method, read it as G1 Survivor Space.

Default: 100[%]

### Tenured Gen (1 to 100)

Specify the threshold for the usage rate of the Java Tenured(Old) Gen area used by the target Java VM. If G1 GC is specified as the GC method, read it as G1 Old Gen.

Default: 80[%]

**Monitor Non-Heap Memory Rate**

Enables the monitoring of the usage rates of the Java non-heap areas used by the target Java VM.

- ◆ When the check box is selected (default):  
Monitoring enabled
- ◆ When the check box is not selected:  
Monitoring disabled

**Total Usage (1 to 100)**

Specify the threshold for the usage rate of the Java non-heap areas used by the target Java VM.

Default: 80[%]

**Code Cache (1 to 100)**

Specify the threshold for the usage rate of the Java Code Cache area used by the target Java VM.

Default: 100[%]

**Perm Gen (1 to 100)**

Specify the threshold for the usage rate of the Java Perm Gen area used by the target Java VM.

Default: 80[%]

**Perm Gen[shared-ro] (1 to 100)**

Specify the threshold for the usage rate of the Java Perm Gen [shared-ro] area used by the target Java VM.

The **Java Perm Gen [shared-ro]** area is used when `-client -Xshare:on -XX:+UseSerialGC` is specified as the startup option of the target Java VM.

Default: 80[%]

**Perm Gen[shared-rw] (1 to 100)**

Specify the threshold for the usage rate of the Java Perm Gen [shared-rw] area used by the target Java VM.

The **Java Perm Gen [shared-rw]** area is used when `-client -Xshare:on -XX:+UseSerialGC` is specified as the startup option of the target Java VM.

Default: 80[%]

**Monitor Virtual Memory Usage (1 to 3072)**

Specify the threshold for the usage of the virtual memory used by the target Java VM. JVM monitor resources do not support the monitoring of virtual memory usage when target Java VM consists of 64-bit processes. Therefore, when the target Java VM consists of 64-bit processes, uncheck this check box.

Default: 2048[MB]

**Command (within 255 bytes)**

Specify the commands that will be executed if errors in the monitor target Java VM are detected. A specific command and argument(s) can be specified for each error cause. Use an absolute path to specify each command. Place the executable file name in double quotes (“”) to specify it.

Example) “/usr/local/bin/command” arg1 arg2

Specify the commands that will be executed if errors are detected in the process for checking the amount of the usage of the Java heap area, Java non-heap area, and virtual memory in the monitor target Java VM.

See “Executing a command corresponding to cause of each detected error”.

Default: None

### **Initialize**

Click **Initialize** to set all the items to their default values.

## Memory tab (when Oracle Java(usage monitoring) is selected for JVM Type)

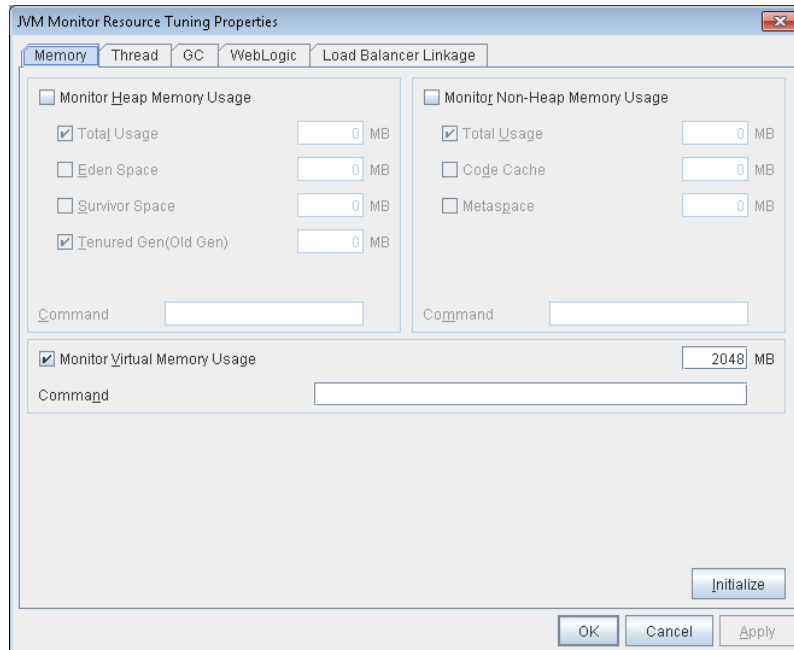

### Monitor Heap Memory Usage

Enables the monitoring of the usage rates of the Java heap areas used by the target Java VM.

- When the check box is selected:  
Monitoring is enabled.
- When the check box not selected (default):  
Monitoring is disabled.

### Total Usage (1 to 102400)

Specify the threshold for the usage rates of the Java heap areas used by the target Java VM.

Default: 0[MB]

### Eden Space (1 to 102400)

Specify the threshold for the usage rate of the Java Eden Space used by the target Java VM. If G1 GC is specified as the GC method, read it as G1 Eden Space.

Default: 0[MB]

### Survivor Space (1 to 102400)

Specify the threshold for the usage rate of the Java Survivor Space used by the target Java VM. If G1 GC is specified as the GC method, read it as G1 Survivor Space.

Default: 0[MB]

### Tenured Gen (1 to 102400)

Specify the threshold for the usage rate of the Java Tenured(Old) Gen area used by the target Java VM. If G1 GC is specified as the GC method, read it as G1 Old Gen.

Default: 0[MB]

### **Monitor Non-Heap Memory Usage**

Enables the monitoring of the usage rate of the Java non-heap areas used by the target Java VM.

- When the check box is selected:  
Monitoring is enabled.
- When the check box is not selected (default):  
Monitoring is disabled.

### **Total Usage** (1 to 102400)

Specify the threshold for the usage rate of the Java non-heap areas used by the target Java VM.

Default: 0[MB]

### **Code Cache** (1 to 102400)

Specify the threshold for the usage rate of the Java Code Cache area used by the target Java VM.

Default: 0[MB]

### **Metaspace** (1 to 102400)

Specify the threshold for the usage rate of the Metaspace area used by the target Java VM.

Default: 0[MB]

### **Monitor Virtual Memory Usage** (1 to 3072)

Specify the threshold for the usage rate of the virtual memory used by the target Java VM. JVM monitor resources do not support the monitoring of virtual memory usage when target Java VM consists of 64-bit processes. Therefore, when the target Java VM consists of 64-bit processes, uncheck this check box.

Default: 2048[MB]

### **Command** (within 255 bytes)

Specify the command to execute if an error is detected in the target Java VM. It is possible to specify the command to execute for each error cause, as well as arguments. Specify a full path. Enclose an executable file name with double quotes (""). Example) `"/usr/local/bin/command" arg1 arg2`

Here, specify the commands to execute if an error is detected in the Java heap area, Java non-heap area, and virtual memory usage usage rate of the target Java VM.

See also "Executing command corresponding to cause of each detected error".

Default: None

### **Initialize**

Click the **Initialize** button to set all the items to their default values.

## Memory tab (when Oracle JRockit is selected for JVM Type)

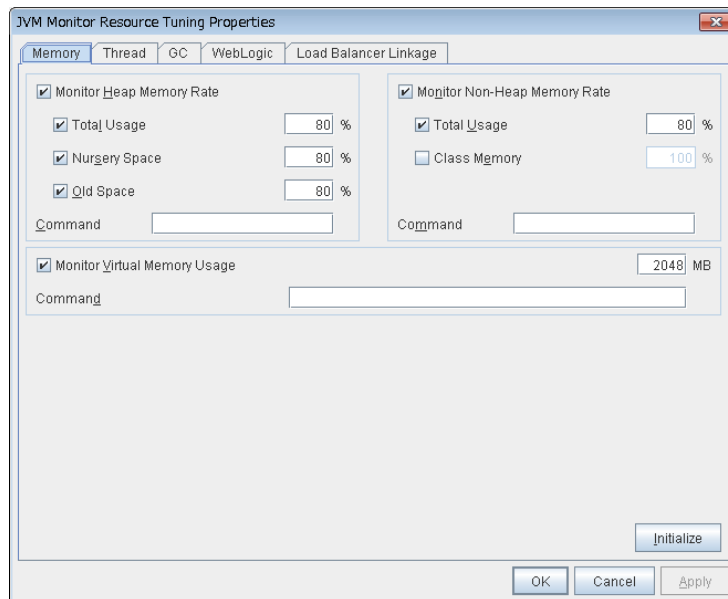

Displayed only when **JRockit** is selected for **JVM Type**.

### Monitor Heap Memory Rate

Enables the monitoring of the usage rates of the Java heap areas used by the target Java VM.

- ◆ When the check box is selected (default):  
Monitoring enabled
- ◆ When the check box is not selected:  
Monitoring disabled

### Total Usage (1 to 100)

Specify the threshold for the usage rate of the Java heap areas used by the target Java VM.

Default: 80[%]

### Nursery Space (1 to 100)

Specify the threshold for the usage rate of the Java Nursery Space used by the target JRockit JVM.

Default: 80[%]

**Old Space (1 to 100)**

Specify the threshold for the usage rate of the Java Old Space used by the target JRockit JVM.

Default: 80[%]

**Monitor Non-Heap Memory Rate**

Enables the monitoring of the usage rates of the Java non-heap areas used by the target Java VM.

- ◆ When the check box is selected (default):  
Monitoring enabled
- ◆ When the check box is not selected:  
Monitoring disabled

**Total Usage (1 to 100)**

Specify the threshold for the usage rate of the Java non-heap areas used by the target Java VM.

Default: 80[%]

**Class Memory (1 to 100)**

Specify the threshold for the usage rate of the Java Class Memory used by the target JRockit JVM.

Default: 100[%]

**Monitor Virtual Memory Usage (1 to 3072)**

Specify the threshold for the usage of the virtual memory used by the target Java VM. JVM monitor resources do not support the monitoring of virtual memory usage when target Java VM consists of 64-bit processes. Therefore, when the target Java VM consists of 64-bit processes, uncheck this check box.

Default: 2048[MB]

**Command (within 255 bytes)**

Specify the commands that will be executed if errors in the monitor target Java VM are detected. A specific command and argument(s) can be specified for each error cause. Use an absolute path to specify each command. Place the executable file name in double quotes (“”) to specify it.

Example) “/usr/local/bin/command” arg1 arg2

Specify the commands that will be executed if errors are detected in the process for checking the amount of the usage of the Java heap area, Java non-heap area, and virtual memory in the monitor target Java VM.

See “Executing a command corresponding to cause of each detected error”.

Default: None

**Initialize**

Click **Initialize** to set all the items to their default values.



## Thread tab

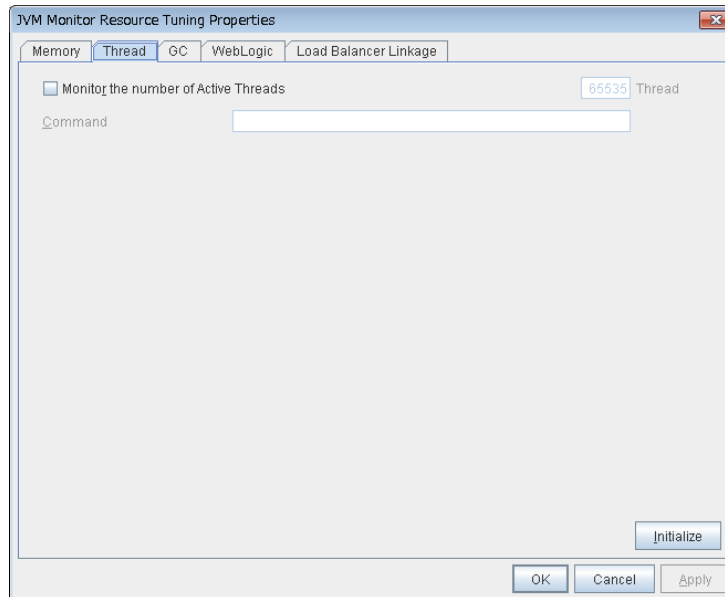

### Monitor the number of Active Threads (1 to 65535)

Specify the upper limit threshold for the number of threads running on the monitor target Java VM.

Default: 65535 [threads]

### Command (within 255 bytes)

Specify the commands that will be executed if errors in the monitor target Java VM are detected. A specific command and argument(s) can be specified for each error cause. Use an absolute path to specify each command. Place the executable file name in double quotes (") to specify it.

Example) "/usr/local/bin/command" arg1 arg2

Specify the commands that will be executed if errors are detected in the process for checking the number of active threads in the monitor target Java VM.

See "Executing a command corresponding to cause of each detected error".

Default: None

### Initialize

Click **Initialize** to set all the items to their default values.

## GC tab

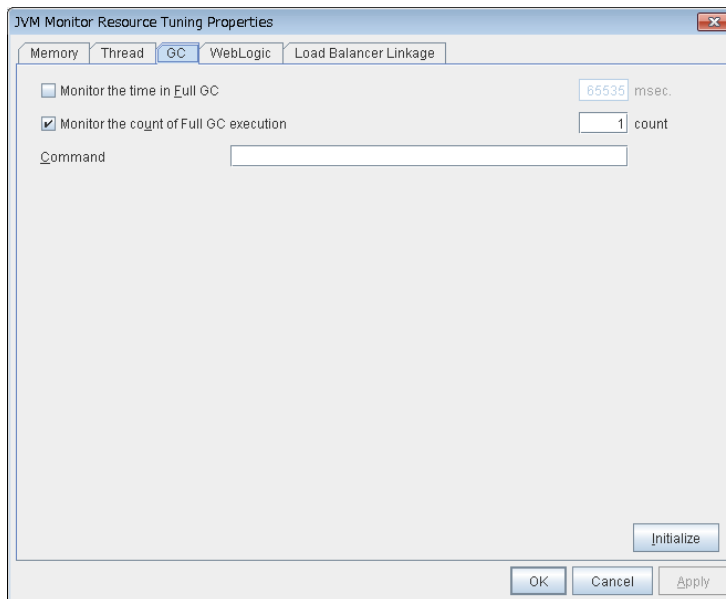

### Monitor the time in Full GC (1 to 65535)

Specify the threshold for the Full GC execution time since previous measurement on the target Java VM. The threshold for the Full GC execution time is the average obtained by dividing the Full GC execution time by the number of times Full GC occurs since the previous measurement.

To determine the case in which the Full GC execution time since the previous measurement is 3000 milliseconds and Full GC occurs three times as an error, specify 1000 milliseconds or less.

Default: 65535 [milliseconds]

### Monitor the count of Full GC execution (1 to 65535)

Specify the threshold for the number of times Full GC occurs since previous measurement on the target Java VM.

Default: 1 (time)

### Command (within 255 bytes)

Specify the commands that will be executed if errors in the monitor target Java VM are detected. A specific command and argument(s) can be specified for each error cause. Use an absolute path to specify each command. Place the executable file name in double quotes (“”) to specify it.

Example) “/usr/local/bin/command” arg1 arg2

Specify the commands that will be executed if errors are detected in the process for measuring time in Full GC and the count of Full GC execution in the monitor target Java VM.

See “Executing a command corresponding to cause of each detected error”.

Default: None

### Initialize

Click **Initialize** to set all the items to their default values.

## WebLogic tab

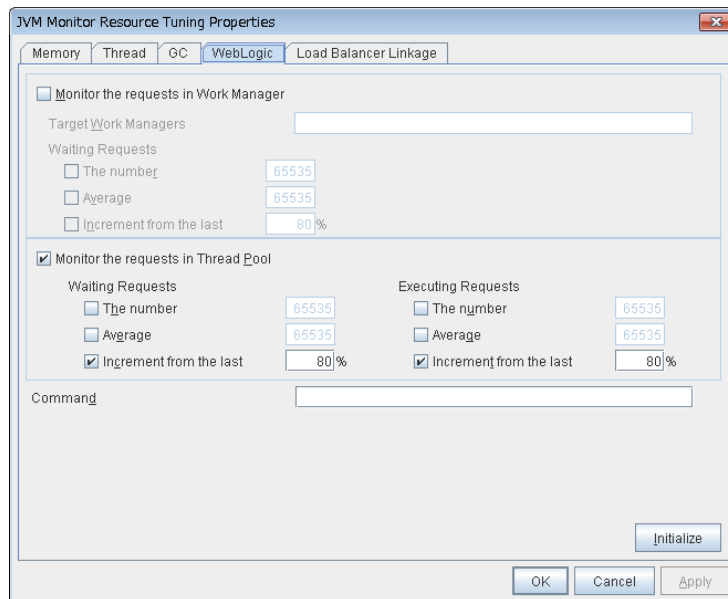

Displayed only when **WebLogic Server** is selected for **Target**.

### Monitor the requests in Work Manager

Enables the monitoring of the wait requests by Work Managers on the WebLogic Server.

- ◆ When the check box is selected:  
Monitoring enabled
- ◆ When the check box is not selected (default):  
Monitoring disabled

### Target Work Managers

Specify the names of the Work Managers for the applications to be monitored on the target WebLogic Server. To monitor Work Managers, you must specify this setting.

*App1*[*WM1*,*WM2*,...];*App2*[*WM1*,*WM2*,...];...

For *App* and *WM*, only ASCII characters are valid (except Shift\_JIS codes 0x005C and 0x00A1 to 0x00DF).

To specify an application that has an application archive version, specify “application\_name#version” in *App*.

When the name of the application contains "[" and/or "]", prefix it with ¥¥.

(Ex.) When the application name is app[2], enter app¥¥[2¥¥].

Default: None

**The number** (1 to 65535)

Specify the threshold for the wait request count for the target WebLogic Server Work Manager(s).

Default: 65535

**Average** (1 to 65535)

Specify the threshold for the wait request count average for the target WebLogic Server Work Manager(s).

Default: 65535

**Increment from the last** (1 to 1024)

Specify the threshold for the wait request count increment since the previous measurement for the target WebLogic Server Work Manager(s).

Default: 80[%]

**Monitor the requests in Thread Pool**

In WebLogic Server thread pool to be monitored, the number of wait requests, and the monitoring settings of the number of executing request. The number of requests, HTTP requests and the number that was waiting to be processed and run inside WebLogic Server, and includes the number of requests of the processing performed by the internal EJB call and WebLogic Server. However, it can not judge an abnormal state to be increased. Please specify if you want to the collection of JVM statistics log.

- ◆ When the check box is selected (default):  
Monitoring enabled
- ◆ When the check box is not selected:  
Monitoring disabled

**Wait Requests The number** (1 to 65535)

Specify the threshold for the wait request count.

Default: 65535

**Wait Request Average** (1 to 65535)

Specify the threshold for the wait request count average.

Default: 65535

**Wait Request Increment from the last** (1 to 1024)

Specify the threshold for the wait request count increment since the previous measurement.

Default: 80[%]

**Executing Requests The number** (1 to 65535)

Specify the threshold for the number of requests executed per unit of time.

Default: 65535

**Executing Requests Average** (1 to 65535)

Specify the threshold for the average count of requests executed per unit of time.

Default: 65535

**Executing Requests Increment from the last (1 to 1024)**

Specify the threshold for the increment of the number of requests executed per unit of time since the previous measurement.

Default: 80[%]

**Command (within 255 bytes)**

Specify the commands that will be executed if errors in the monitor target Java VM are detected. A specific command and argument(s) can be specified for each error cause. Use an absolute path to specify each command. Place the executable file name in double quotes (") to specify it.

Example) "/usr/local/bin/command" arg1 arg2

Specify the commands that will be executed if errors are detected in the process for executing requests in the Work Manager and Thread Pool of WebLogic Server.

See "Executing a command corresponding to cause of each detected error".

Default: None

**Initialize**

Click **Initialize** to set all the items to their default values.

## Load Balancer Linkage tab

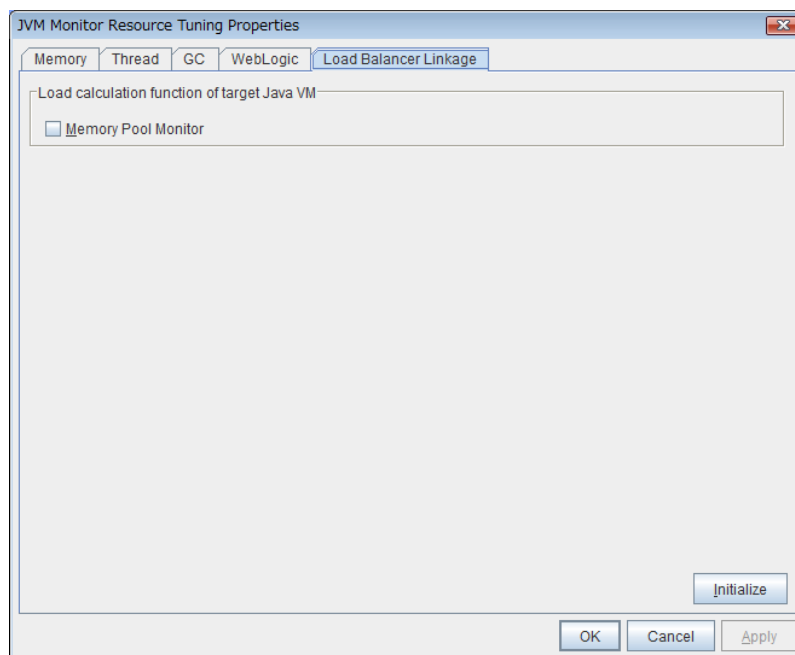

This screen appears when an item other than **BIG-IP LTM** is selected as the load balancer type.

### Memory Pool Monitor

Enables the monitoring of the memory pool when notifying the load balancer of dynamic load information.

- ◆ When the check box is selected:  
Monitoring enabled
- ◆ When the check box is not selected (default):  
Monitoring disabled

### Initialize

Click the **Initialize** button to set all the items to their default values.

## Load Balancer Linkage tab

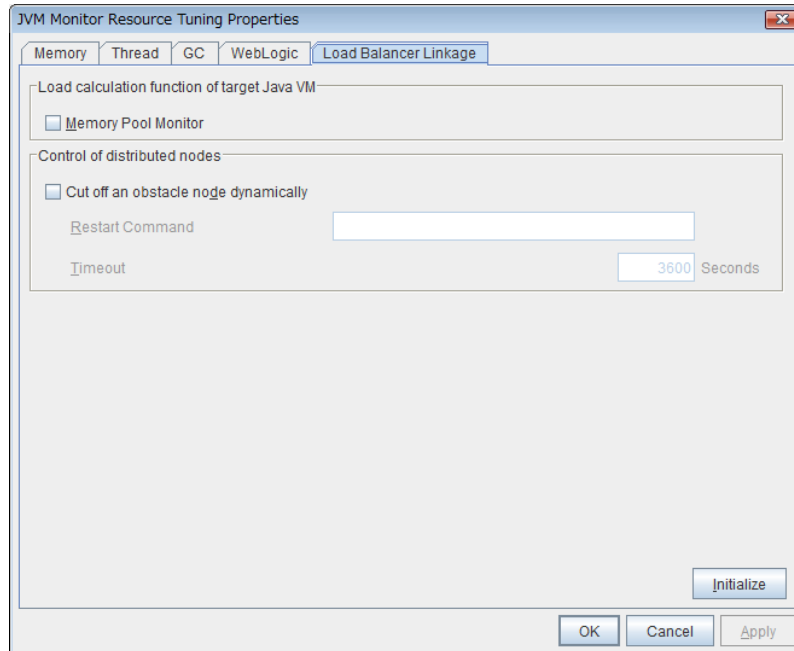

This screen appears when **BIG-IP LTM** is selected as the load balancer type.

### Memory Pool Monitor

Enables the monitoring of the memory pool when notifying the load balancer of dynamic load information.

- ◆ When the check box is selected:  
Monitoring enabled
- ◆ When the check box is not selected (default):  
Monitoring disabled

### Cut off an obstacle node dynamically

When the JVM monitor detects a monitor target failure (example: the collection information exceeds the configured threshold), it sets whether to update the status of the BIG-IP LTM distributed node from “enable” to “disable.”

- ◆ When the check box is selected:  
Update the status from enable to disable.
- ◆ When the check box is not selected (default):  
Do not update.

### Restart Command

Specify the absolute path of the command to be executed after waiting until the number of connections of the distributed node becomes 0. This function is effective when the monitor target is restarted when resident monitoring is performed and a monitor target failure is detected. Specify the same value between JVM monitor resources.

**Timeout** (0 to 2592000)

After updating the distributed node status from “enable” to “disable,” the JVM monitor sets the timeout used when waiting until the number of connections of the distributed node falls to 0. If the timeout elapses, **[Restart Command]** is not executed.

Default: 3600 [sec]

**Initialize**

Click the **Initialize** button to set **Memory Pool Monitor**, **Cut off an obstacle node dynamically**, and **Timeout** to their default values.



## Displaying the JVM monitor resource properties with the WebManager

1. Start the WebManager.
2. When you click an object for a JVM monitor resource  in the tree view, the following information is displayed in the list view.

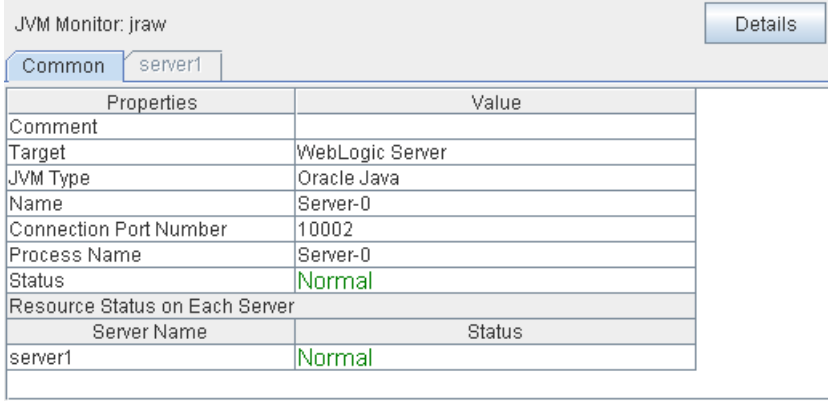

The screenshot shows a dialog box titled "JVM Monitor: jraw" with a "Details" button. It has two tabs: "Common" and "server1". The "Common" tab is active, displaying a table of properties and values. Below the main table is a section titled "Resource Status on Each Server" with a sub-table.

Properties	Value
Comment	
Target	WebLogic Server
JVM Type	Oracle Java
Name	Server-0
Connection Port Number	10002
Process Name	Server-0
Status	Normal
Resource Status on Each Server	
Server Name	Status
server1	Normal

Target:	Name of the target application server
JVM Type:	Java VM on which the target application server runs
Name:	Name that uniquely identifies the target Java VM
Connection Port Number:	Number of port used to establish a connection to the target Java VM
Process Name:	Character string that uniquely identifies the target Java VM process
Status:	Status of the JVM monitor resource
Resource Status on Each Server	
Server Name:	Name of the server
Status:	Monitor source status on the server

When you click **Details**, the following information is displayed in the pop-up dialog box:

Properties	Value
Name	jraw1
Type	jraw
Monitor Timing	Activating
Target Resource	exec1
Interval (sec)	60
Timeout (sec)	120
Do Not Retry at Timeout Occurrence	Off
Do Not Execute Recovery Action at Timeout Occurrence	Off
Retry Count	0
Final Action	No operation
Execute Script Before Reactivation	Off
Execute Script Before Failover	Off
Execute Script before Final Action	Off
Recovery Target	LocalServer
Recovery Target Type	Itself
Recovery Script Threshold	0
Reactivation Threshold	0
Failover Threshold	0
Wait Time to Start Monitoring (sec)	0
Nice Value	0
Monitor Suspend Possibility	Possible
Dummy Failure Possibility	Possible
Collect Dump at Timeout Occurrence	Off
Run Migration Before Run Failover	Off

**Name:** JVM monitor resource name

**Type:** Monitor resource type

**Monitor Timing:** Timing to start monitoring

**Target Resource:** Resource to be monitored

**Interval(sec):** Interval between monitoring (in seconds)

**Timeout(sec):** Timeout for monitoring (in seconds)

**Do Not Retry at Timeout Occurrence:** Whether or not to retry when timeout occurs

**Do Not Execute Recovery Action at Timeout Occurrence:** Whether or not to execute recovery action when timeout occurs

**Retry Count:** The number of retries to detect an error with the monitor resource after detecting a monitor target error

**Final Action:** Final action at detection of an error

**Execute Script before Reactivation:** Whether the pre-reactivation script is executed upon the detection of an error

**Execute Script before Failover:** Whether the pre-failover script is executed upon the detection of an error

**Execute Script before Final Action:** Whether or not the script is executed when a failure is detected

**Recovery Target:** Target to be recovered when an error is detected

**Recovery Target Type:** Type of the target to be recovered when an error is detected

**Recovery Script Threshold:** The number of times the recovery script is executed upon the detection of an error

**Reactivation Threshold:** The number of reactivations to be made at detection of an error

**Failover Threshold:** The number of failovers to be made at detection of an error

**Wait Time to Start Monitoring(sec):** Time to wait before starting monitoring (in seconds)

**Nice Value:** Monitor resource nice value

**Monitor Suspend Possibility:** Possibility of suspending monitoring

**Dummy Failure Possibility:** Possibility of Dummy Failure

**Collect Dump at Timeout Occurrence:** Whether or not dump is collected when timeout occurs

**Run Migration Before Run Failover:** Whether or not migration is run before running failover

## Understanding system monitor resources

System monitor resources periodically collect statistical information about resources used by processes and analyze the information according to given knowledge data. System monitor resources serve to detect the exhaustion of resources early according to the results of analysis.

### Notes on system monitor resource

To use a system monitor resource, zip and unzip packages must have been installed on the servers.

For the supported versions of System Resource Agent, see “Software Applications supported by monitoring options” in Chapter 3, “Installation requirements for EXPRESSCLUSTER” in the *Getting Started Guide*.

System Resource Agent may output operation logging for each monitoring operation.

For the recovery target, specify the resource to which fail-over is performed upon the detection of an error in resource monitoring by System Resource Agent.

The use of the default System Resource Agent settings is recommended.

Errors in resource monitoring may be undetectable when:

- A value repeatedly exceeds and then falls below a threshold during whole system resource monitoring.

Swapped out processes are not subject to the detection of resource errors.

If the date or time of the OS has been changed while System Resource Agent is running, resource monitoring may operate incorrectly as described below because the timing of analysis which is normally done at 10 minute intervals may differ the first time after the date or time is changed. If either of the following occur, suspend and resume cluster.

- No error is detected even after the specified duration for detecting errors has passed.
- An error is detected before the specified duration for detecting errors has elapsed.

Once the cluster has been suspended and resumed, the collection of information is started from that point of time.

For the SELinux setting, set permissive or disabled.

The enforcing setting may disable the communication needed by EXPRESSCLUSTER.

The amount of process resources and system resources used is analyzed at 10-minute intervals. Thus, an error may be detected up to 10 minutes after the monitoring session.

The amount of disk resources used is analyzed at 60-minute intervals. Thus, an error may be detected up to 60 minutes after the monitoring session.

Specify a value smaller than the actual disk size when specifying the disk size for free space monitoring of a disk resource. If a value is specified that is larger than the actual disk size, an error will be detected due to insufficient free space.

If the monitored disk has been replaced, analyzed information up until the time of the disk replacement will be cleared if one of the following items of information differs between the previous and current disks.

- Total disk capacity
- File system

Disk resource monitoring can only monitor disk devices.

For server for which no swap was allocated, uncheck the monitoring of total virtual memory usage.

Disk usage information collected by System Resource Agent is calculated by using the total disk space and free disk space. This value may slightly differ from the disk usage which `df(1)` command shows because it uses a different calculation method.

Up to 64 disk units can be simultaneously monitored by the disk resource monitoring function.

If **system monitor** is not displayed in the **Type** column on the monitor resource definition screen, select **Get License Info** and then acquire the license information.

## How system monitor resources perform monitoring

System monitor resources monitor the following:

Periodically collect the amounts of process resources, system resources and disk resources used and then analyze the amounts.

An error is recognized if the amount of a resource used exceeds a pre-set threshold.

When an error detected state persists for the monitoring duration, it is posted as an error detected during resource monitoring.

If process resource monitoring (of the CPU, memory, number of threads, or number of zombie processes) operated by using the default values, a resource error is reported after 24 hours.

The following chart describes how process resource monitoring detects memory usage errors.

- ◆ In the following example, as time progresses, memory usage increases and decreases, the maximum value is updated more times than specified, and increases by more than 10% from its initial value.

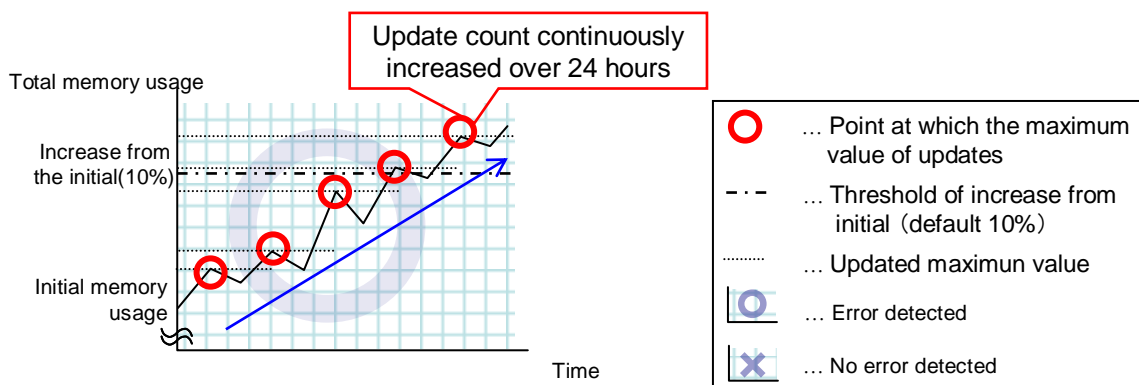

→ Memory leak will be detected as memory usage continuously increased over 24hours (by default), and it increased more than 10% from its initial value.

- ◆ In the following example, memory usage increases and decreases, but remains within a set range.

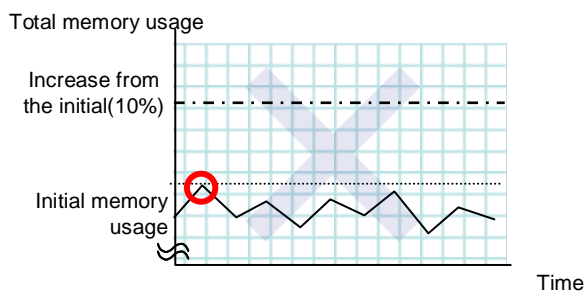

→ Memory leak will not be detected as memory usage repeat increasing and decreasing within certain range (below specific value).

System resource monitoring with the default values reports an error found in resource monitoring 60 minutes later if the resource usage does not fall below 90%.

The following shows an example of error detection for the total memory usage in system resource monitoring with the default values.

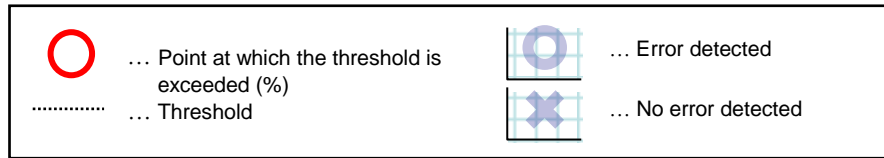

- ◆ The total memory usage remains at the total memory usage threshold or higher as time passes, for at least a certain duration of time.

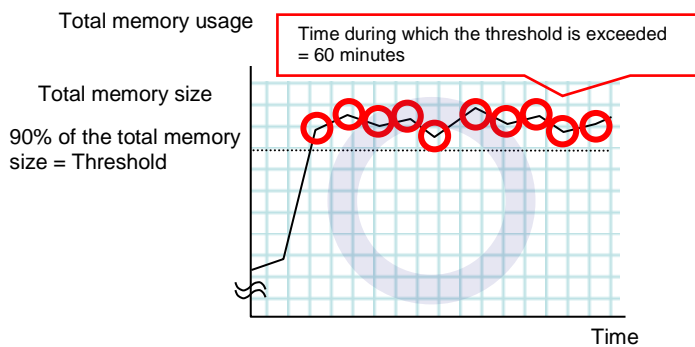

→ The total memory usage remains at the threshold (90%) or higher continuously for the monitoring duration time (60 minutes) or longer; detection of a total memory usage error is recognized.

- ◆ The total memory usage rises and falls in the vicinity of the total memory usage threshold as time passes, but always remains under that threshold.

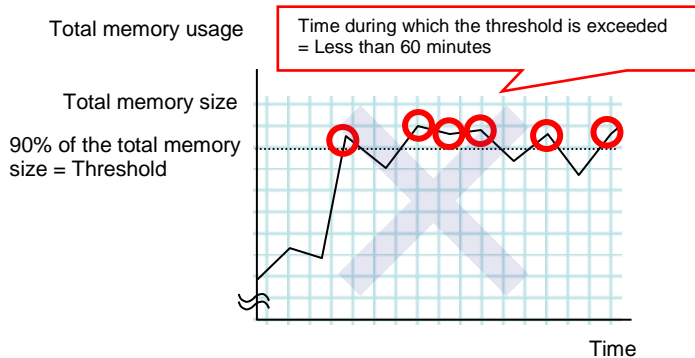

→ The total memory usage is temporarily at the total memory usage threshold (90%) or higher, but goes below the threshold before it remains at the threshold or higher continuously for the monitoring duration time (60 minutes); no total memory usage error is detected.

If disk resource monitoring operated under the default settings, it will report a notice level error after 24 hours.

The following chart describes how disk resource monitoring detects disk usage errors when operating under the default settings.

**Monitoring disk usage by warning level**

- ◆ In the following example, disk usage exceeds the threshold which is specified as the warning level upper limit.

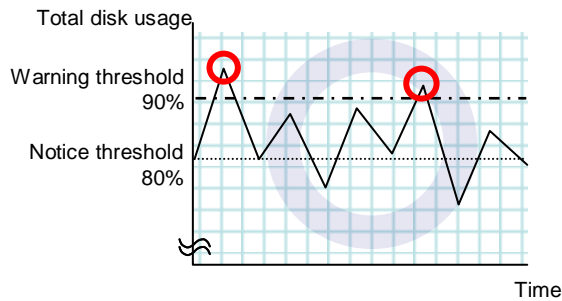

→ Disk usage error will be detected as disk usage exceed the threshold which configured as warning level upper limit.

- ◆ In the following example, disk usage increases and decreases within certain range, and does not exceed the threshold which is specified as the warning level upper limit.

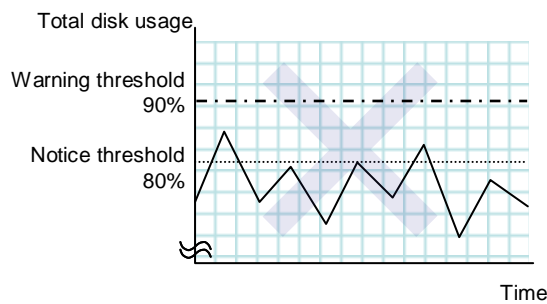

→ Disk usage error will not be detected as disk usage repeat increasing and decreasing within certain range(below warning level upper limit).

**Monitoring disk usage by notice level**

- ◆ In the following example, disk usage continuously exceeds the threshold specified as the notification level upper limit, and the duration exceeds the set length.

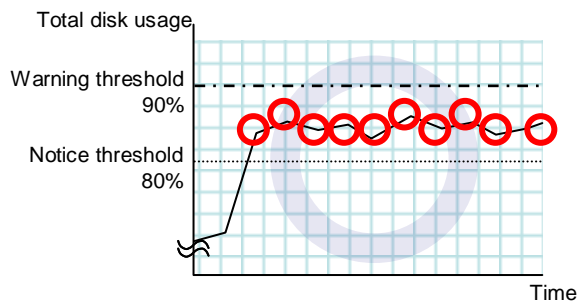

→ Disk usage error will be detected as disk usage continuously exceed notice level upper limit.

- ◆ In the following example, disk usage increases and decreases within a certain range, and does not exceed the threshold specified as the notification level upper limit.

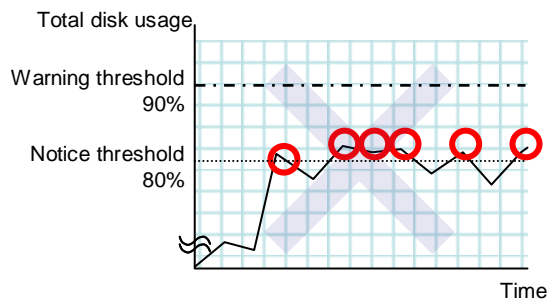

→ Disk usage error will not be detected as disk usage repeat increasing and decreasing around notice level upper limit.

## Displaying and changing the system monitor resource details

1. Click the **Monitors** icon on the tree view displayed on the left side of the Builder window.
2. A list of the monitor resources is displayed in the table view on the right side of the screen. Right-click the target system monitor resource, and click the **Monitor(special)** tab in the **Monitor Resource Property** window.
3. On the **Monitor(special)** tab, you can see and/or change the detailed settings as described below.

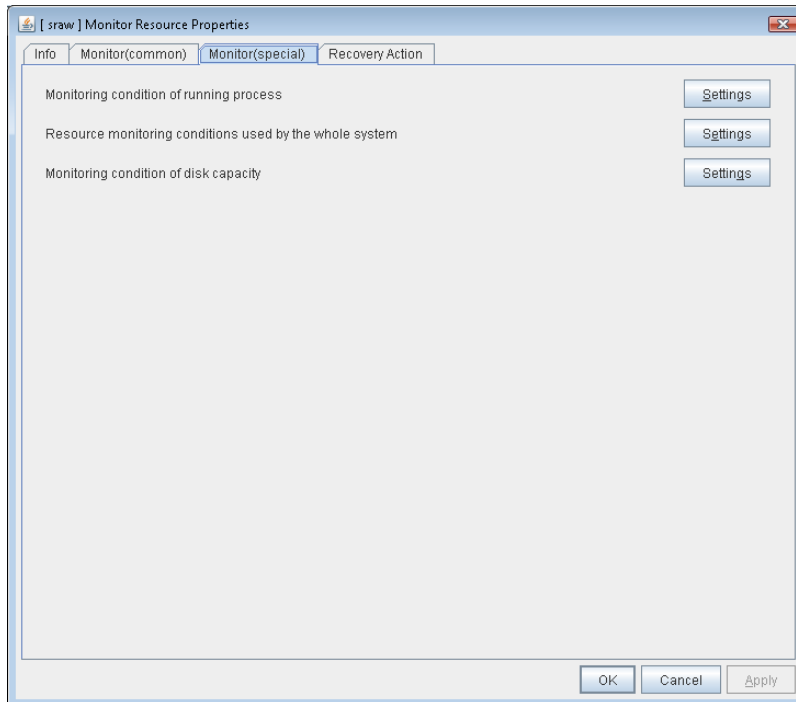

### Settings

Click the **Settings** button for **Monitoring condition of running process**; the process settings dialog box appears.

Click the **Settings** button for **Resource monitoring conditions used by the whole system**; the system settings dialog box appears.

Click the **Settings** button for **Monitoring condition of disk capacity**; the disk list dialog box appears.

Configure detailed settings for the monitoring of error detection according to the descriptions of the dialog boxes.



## System Resource Agent process settings

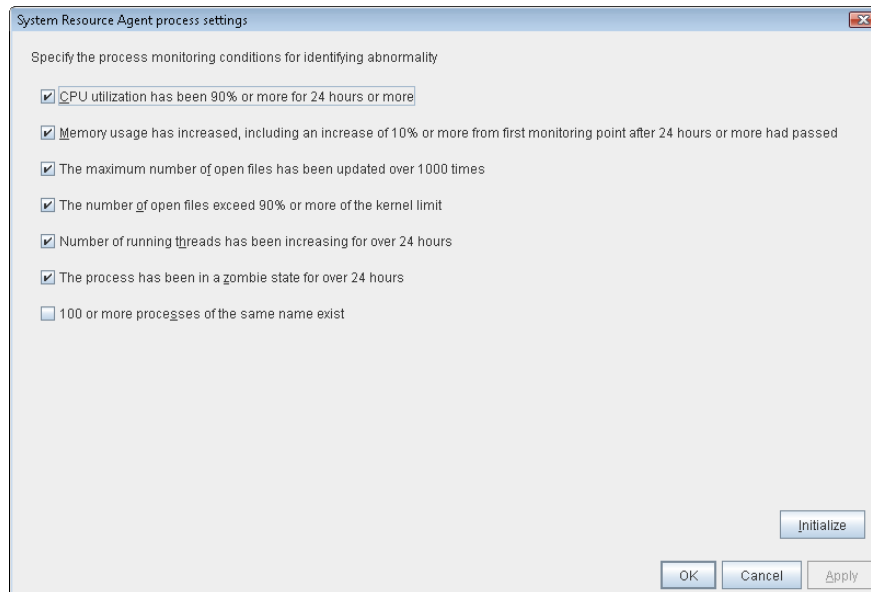

### **CPU utilization has been 90% or more for 24 hours or more**

Enables the monitoring of processes for which CPU utilization has been continuously 90% or more for 24 hours or more.

- ◆ When the check box is selected:  
Monitoring is enabled for processes for which CPU utilization has been continuously 90% or more for 24 hours or more.
- ◆ When the check box is not selected:  
Monitoring is disabled for processes for which CPU utilization has been continuously 90% or more for 24 hours or more.

### **Memory usage has increased, including an increase of 10% or more from first monitoring point after 24 hours or more had passed**

Enables the monitoring of processes for which the memory usage has increased, including an increase of 10% or more from the first the monitoring point after 24 hours or more had passed.

- ◆ When the check box is selected:  
Monitoring is enabled for processes for which the memory usage has increased, including an increase of 10% or more from the first monitoring point after 24 hours or more has passed.
- ◆ When the check box is not selected:  
Monitoring is disabled for processes for which the memory usage has increased, including an increase of 10% or more from the first monitoring point after 24 hours or more has passed.

**The maximum number of open files has been updated over 1000 times**

Enables the monitoring of processes for which the maximum number of open files has been exceeded over 1000 times.

- ◆ When the check box is selected:  
Monitoring is enabled for processes for which the maximum number of open files has been exceeded over 1000 times.
- ◆ When the check box is not selected:  
Monitoring is disabled for processes for which the maximum number of open files has been exceeded over 1000 times.

**The number of open files exceed 90% or more of the kernel limit**

Enables the monitoring of processes for which the number of open files exceeds 90% or more of the kernel limit.

- ◆ When the check box is selected:  
Monitoring is enabled for processes for which the number of open files exceeds 90% or more of the kernel limit.
- ◆ When the check box is not selected:  
Monitoring is disabled for processes for which the number of open files exceeds 90% or more of the kernel limit.

**Number of running threads has been increasing for over 24 hours**

Enables the monitoring of processes for which the number of running threads has been increasing for over 24 hours.

- ◆ When the check box is selected:  
Monitoring is enabled for processes for which the number of running threads has been increasing for over 24 hours.
- ◆ When the check box is not selected:  
Monitoring is disabled for processes for which the number of running threads has been increasing for over 24 hours.

**The process has been in a zombie state for over 24 hours**

Enables the monitoring of processes that have been in a zombie state for over 24 hours.

- ◆ When the check box is selected:  
Monitoring is enabled for processes that have been in a zombie state for over 24 hours.
- ◆ When the check box is not selected:  
Monitoring is disabled for processes that have been in a zombie state for over 24 hours.

**100 or more processes of the same name exist**

Enables the monitoring of processes for which there are 100 or more processes having the same name.

- ◆ When the check box is selected:  
Monitoring is enabled for processes for which there are 100 or more processes having the same name.
- ◆ When the check box is not selected:  
Monitoring is disabled for processes for which there are 100 or more processes having the same name.

## System Resource Agent system settings

System Resource Agent system settings

Specify the system monitoring conditions for identifying abnormality

Monitoring CPU usage  
 CPU usage  %  
 Duration Time  min

Monitoring total usage of memory  
 Total usage of memory  %  
 Duration Time  min

Monitoring total usage of virtual memory  
 Total usage of virtual memory  %  
 Duration Time  min

Monitoring total number of opening files  
 Total number of opening files (in a ratio comparing with the system upper limit)  %  
 Duration Time  min

Monitoring total number of running threads  
 Total number of running threads  %  
 Duration Time  min

Monitoring number of running process of each user  
 Number of running process of each user  %  
 Duration Time  min

### Monitoring CPU usage

Enables CPU usage monitoring.

- ◆ When the check box is selected:  
Monitoring is enabled for the CPU usage.
- ◆ When the check box is not selected:  
Monitoring is disabled for the CPU usage.

### CPU usage (0 to 100)

Specify the threshold for the detection of the CPU usage.

### Duration Time (1 to 1440)

Specify the duration for detecting the CPU usage.

If the threshold is continuously exceeded over the specified duration, the detection of an error is recognized.

### **Monitoring total usage of memory**

Enables the monitoring of the total usage of memory.

- ◆ When the check box is selected:  
Monitoring is enabled for the total usage of memory.
- ◆ When the check box is not selected:  
Monitoring is disabled for the total usage of memory.

### **Total usage of memory e (0 to 100)**

Specify the threshold for the detection of a memory use amount error (percentage of the memory size implemented on the system).

### **Duration Time (1 to 1440)**

Specify the duration for detecting a total memory usage error.

If the threshold is continuously exceeded over the specified duration, the detection of an error is recognized.

### **Monitoring total usage of virtual memory**

Enables the monitoring of the total **usage of virtual memory**.

- ◆ When the check box is selected:  
Monitoring is enabled for the total **usage of virtual memory**.
- ◆ When the check box is not selected:  
Monitoring is disabled for the total **usage of virtual memory**.

### **Total usage of virtual memory (0 to 100)**

Specify the threshold for the detection of a virtual memory usage error.

### **Duration Time (1 to 1440)**

Specify the duration for detecting a total virtual memory usage error.

If the threshold is continuously exceeded over the specified duration, the detection of an error is recognized.

### **Monitoring total number of opening files**

Enables the monitoring of the total number of opening files.

- ◆ When the check box is selected:  
Monitoring is enabled for the total number of opening files.
- ◆ When the check box is not selected:  
Monitoring is disabled for the total number of opening files.

### **Total number of opening files (in a ratio comparing with the system upper limit) (0 to 100)**

Specify the threshold for the detection of an error related to the total number of opening files (percentage of the system upper limit).

**Duration Time (1 to 1440)**

Specify the duration for detecting an error with the total number of opening files.

If the threshold is continuously exceeded over the specified duration, the detection of an error is recognized.

**Monitoring total number of running threads**

Enables the monitoring of the total number of running threads.

- ◆ When the check box is selected:  
Monitoring is enabled for the total number of running threads.
- ◆ When the check box is not selected:  
Monitoring is disabled for the total number of running threads.

**Total number of running threads (0 to 100)**

Specify the threshold for the detection of an error related to the total number of running threads (percentage of the system upper limit).

**Duration Time (1 to 1440)**

Specify the duration for detecting an error with the total number of running threads.

If the threshold is continuously exceeded over the specified duration, the detection of an error is recognized.

**Monitoring number of running processes of each user**

Enables the monitoring of the number of processes being run **of each user**

- ◆ When the check box is selected:  
Monitoring is enabled for the number of processes being run **of each user**.
- ◆ When the check box is not selected:  
Monitoring is disabled for the number of processes being run **of each user**.

**Number of running processes of each user (0 to 100)**

Specify the threshold for the detection of an error related to the number of processes being run **of each user** (percentage of the system upper limit).

**Duration Time (1 to 1440)**

Specify the duration for detecting an error with the number of processes being run **of each user**.

If the threshold is continuously exceeded over the specified duration, the detection of an error is recognized.

## System Resource Agent disk list

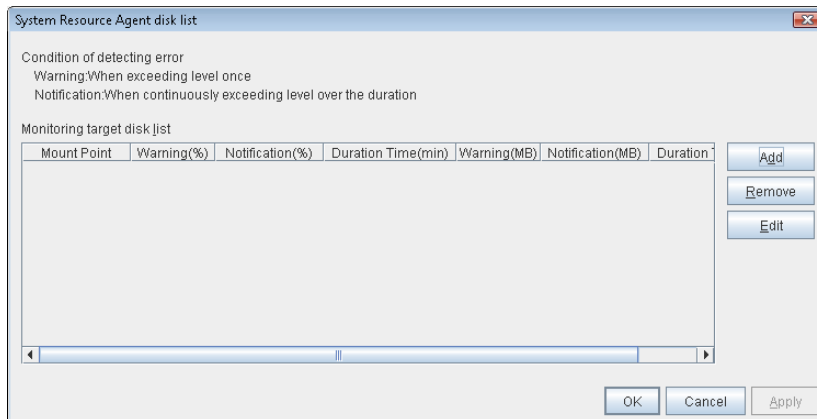

### Add

Click this to add disks to be monitored. The **Input of watch condition** dialog box appears.

Configure the detailed monitoring conditions for error determination, according to the descriptions given in the **Input of watch condition** dialog box.

### Remove

Click this to remove a disk selected in **Disk List** so that it will no longer be monitored.

### Edit

Click this to display the **Input of watch condition** dialog box. The dialog box shows the monitoring conditions for the disk selected in **Disk List**. Edit the conditions and click **OK**.

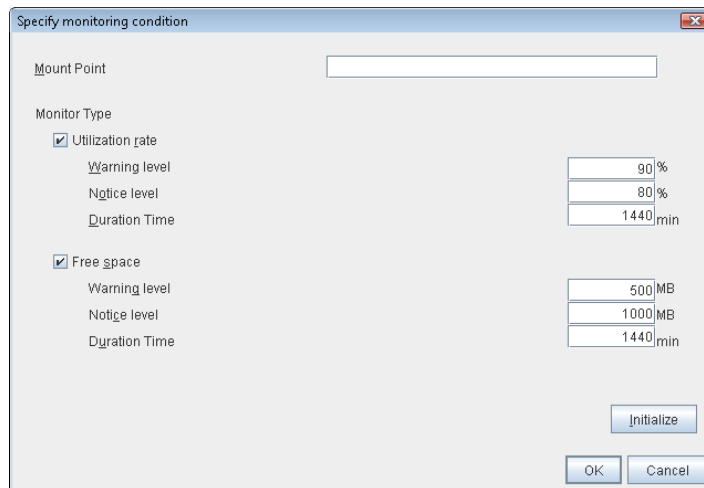

**Mount point**

Set the mountpoint to be monitored. The name must begin with a forward slash (/).

**Utilization rate**

Enables the monitoring of the disk usage.

- ◆ When the check box is selected:  
Monitoring is enabled for the disk usage.
- ◆ When the check box is not selected:  
Monitoring is disabled for the disk usage.

**Warning level (1 to 100)**

Specify the threshold for warning level error detection for disk usage.

**Notice level (1 to 100)**

Specify the threshold for notice level error detection for disk usage.

**Duration Time (1 to 43200)**

Specify the duration for detecting a notice level error of the disk usage rate.

If the threshold is continuously exceeded over the specified duration, the detection of an error is recognized.

**Free space**

Enables the monitoring of the free disk space.

- ◆ When the check box is selected:  
Monitoring is enabled for the free disk space.
- ◆ When the check box is not selected:  
Monitoring is disabled for the free disk space.

**Warning level (1 to 4294967295)**

Specify the amount of disk space (in megabytes) for which the detection of an free disk space error at the warning level is recognized.

**Notice level (1 to 4294967295)**

Specify the amount of disk space (in megabytes) for which the detection of an free disk space error at the notice level is recognized.

**Duration Time (1 to 43200)**

Specify the duration for detecting a notice level error related to the free disk space.

If the threshold is continuously exceeded over the specified duration, the detection of an error is recognized.

## Displaying the system monitor resource properties with the WebManager

1. Start the WebManager.
2. When you click an object for a system monitor resource  in the tree view, the following information is displayed in the list view.

System Monitor Name: saw		Details
<div style="display: flex; border-bottom: 1px solid black;"> <span style="border: 1px solid black; padding: 2px 5px;">Common</span> <span style="border: 1px solid black; padding: 2px 5px; margin-left: 5px;">server1</span> <span style="border: 1px solid black; padding: 2px 5px; margin-left: 5px;">server2</span> </div>		
Properties	Value	
Comment		
Status	Normal	
Resource Status on Each Server		
Server Name	Status	
server1	Offline	
server2	Offline	

<p><b>Comment:</b></p> <p><b>Status:</b></p> <p><b>Resource Status on Each Server:</b></p> <p><b>Server Name:</b></p> <p><b>Status:</b></p>	<p>Comment on the system monitor resource</p> <p>Status of the system monitor resource</p>
<p><b>Name of the server</b></p> <p><b>Status of the monitor resource on the server</b></p>	

When you click **Details**, the following information is displayed in the pop-up dialog box:



Properties	Value
Name	sraw1
Type	sraw
Monitor Timing	Always
Target Resource	
Interval (sec)	30
Timeout (sec)	60
Do Not Retry at Timeout Occurrence	Off
Do Not Execute Recovery Action at Timeout Occurrence	Off
Retry Count	0
Final Action	No operation
Execute Script Before Reactivation	Off
Execute Script Before Failover	Off
Execute Script before Final Action	Off
Recovery Target	LocalServer
Recovery Target Type	Itself
Recovery Script Threshold	0
Reactivation Threshold	0
Failover Threshold	0
Wait Time to Start Monitoring (sec)	0
Nice Value	0
Monitor Suspend Possibility	Possible
Dummy Failure Possibility	Possible
Collect Dump at Timeout Occurrence	Off
Run Migration Before Run Failover	Off
System : Monitoring CPU Usage	On
System : CPU Rate (%)	90
System : CPU Monitoring Duration (sec)	3600
System : Monitoring Memory Usage	On
System : Memory Usage Rate (%)	90
System : Memory Usage Monitoring Duration (sec)	3600
System : Monitoring Virtual Memory	On
System : Virtual Memory (VM) Usage Rate (%)	90
System : VM Usage Monitoring Duration (sec)	3600
System : Monitoring Open File Num	On
System : Open File Num Rate (%)	90
System : Open File Num Monitoring Duration (sec)	3600
System : Monitoring Thread Usage	On
System : Thread Usage Rate (%)	90
System : Thread Usage Monitoring Duration (sec)	3600
System : Monitoring Max User Process Count	On
System : Max User Process Count (%)	90
System : Max User Process Monitoring Duration (sec)	3600
Process : Monitoring CPU Usage	On
Process : Monitoring Memory Leak	On
Process : Monitoring File Leak	On
Process : Monitoring Open File Num	On
Process : Monitoring Thread Leak	On
Process : Monitoring Defunct Process	On
Process : Monitoring Same Name Process Count	Off
Disk : Mount Point	

- Name: System monitor resource name
- Type: Monitor resource type
- Monitor Timing: Timing to start monitoring
- Target Resource: Resource to be monitored
- Interval: Interval between monitoring (in seconds)
- Timeout(sec): Timeout for monitoring (in seconds)
- Do Not Retry at Timeout Occurrence: Whether or not to retry when timeout occurs
- Do Not Execute Recovery Action at Timeout Occurrence: Whether or not to execute recovery action when timeout occurs
- Retry Count: The number of retries to detect an error with the monitor resource after detecting a monitor target error
- Final Action: Final action at detection of an error

Execute Script before Reactivation:	Whether the pre-reactivation script is executed upon the detection of an error
Execute Script before Failover:	Whether the pre-failover script is executed upon the detection of an error
Execute Script before Final Action:	Whether or not the script is executed when a failure is detected
Dummy Failure Possibility:	Possibility of Dummy Failure
Recovery Target:	Target to be recovered when an error is detected
Recovery Target Type:	Type of the target to be recovered when an error is detected
Recovery Script Threshold:	The number of times the recovery script is executed upon the detection of an error
Reactivation Threshold:	The number of reactivations to be made at detection of an error
Failover Threshold:	The number of failovers to be made at detection of an error
Wait Time to Start Monitoring:	Time to wait before starting monitoring (in seconds)
Nice Value:	Monitor resource nice value
Monitor Suspend Possibility:	Possibility of suspending monitoring
Collect Dump at Timeout Occurrence:	Whether or not dump is collected when timeout occurs
Run Migration Before Run Failover:	Whether or not migration is run before running failover
System: Monitoring CPU Usage:	CPU usage monitoring enabled/disabled
System: CPU Rate (%):	Threshold for detection of the CPU usage error (%)
System: CPU Monitoring Duration (sec):	Duration for detecting a CPU usage error (seconds)
System: Monitoring Memory Usage:	Memory usage monitoring enabled/disabled
System: Memory Usage Rate (%):	Threshold for detection of a memory usage error (%)
System: Memory Usage Monitoring Duration (sec):	Duration for detecting a memory usage error (seconds)
System: Monitoring Virtual Memory Usage:	Virtual memory usage monitoring enabled/disabled
System: Virtual Memory (VM) Usage Rate (%):	Threshold for detection of a virtual memory usage error (%)
System: VM Usage Monitoring Duration (sec):	Duration for detecting a virtual memory usage error (seconds)
System: Monitoring Open File Num:	Number of open files monitoring enabled/disabled
System: Open File Num Rate (%):	Threshold for detection of an error related to the total number of open files (%)
System: Open File Num Monitoring Duration (sec):	Duration for detecting an error related to the total number of open files (seconds)
System: Monitoring Thread Usage:	Number of threads monitoring enabled/disabled
System: Thread Usage Rate (%):	Threshold for detection of an error related to the total number of threads (%)
System: Thread Usage Monitoring Duration (sec):	Duration for detecting for an error related to the total number of threads (seconds)
System: Monitoring Max User Process Count:	Number of user processes monitoring enabled/disabled
System: Max User Process Count (%):	Threshold for detection of an error related to the number of processes being run by a user (%)

System: Max User Process Monitoring Duration (sec):	Duration for detecting an error related to the number of processes being run by a user (seconds)
Process: Monitoring CPU Usage:	CPU usage monitoring enabled/disabled
Process: Monitoring Memory Leak:	Memory leak monitoring enabled/disabled
Process: Monitoring File Leak:	File leak monitoring enabled/disabled
Process: Monitoring Open File Num:	Number of open files monitoring enabled/disabled
Process: Monitoring Thread Leak:	Thread leak monitoring enabled/disabled
Process: Monitoring Defunct Process:	Zombie process monitoring enabled/disabled
Process: Monitoring Same Name Process Count:	Process multiplicity monitoring enabled/disabled
Disk: Mount Point:	Point at which the disk subject to the system monitor resource monitoring is mounted

## Understanding AWS elastic ip monitor resources

For EIP control, AWS elastic ip monitor resources confirm the existence of EIPs by using the AWS CLI command.

### Notes on AWS elastic ip monitor resources

- ◆ AWS elastic ip monitor resources are automatically created when AWS elastic ip resources are added. A single AWS elastic ip monitor resource is automatically created for a single AWS elastic ip resource.
- ◆ See "Setting up AWS elastic ip resources" in "Notes when creating EXPRESSCLUSTER configuration data" in Chapter 5, "Notes and Restrictions" in the *Getting Started Guide*.

### Applying environment variables to AWS CLI run from the AWS elastic ip monitor resource

See "Applying environment variables to AWS CLI run from the AWS elastic ip resource" in this guide

### Displaying and changing the AWS elastic ip monitor resource details

1. In the tree view shown on the left pane of the Builder, click the **Monitors** icon.
2. A list of monitor resources is shown in the table view on the right side of the screen. Right-click the target AWS elastic ip monitor resource, and click **Properties**, and then click the **Monitor(special)** tab.
3. On the **Monitor(special)** tab, you can see and/or change the detailed settings as described below.

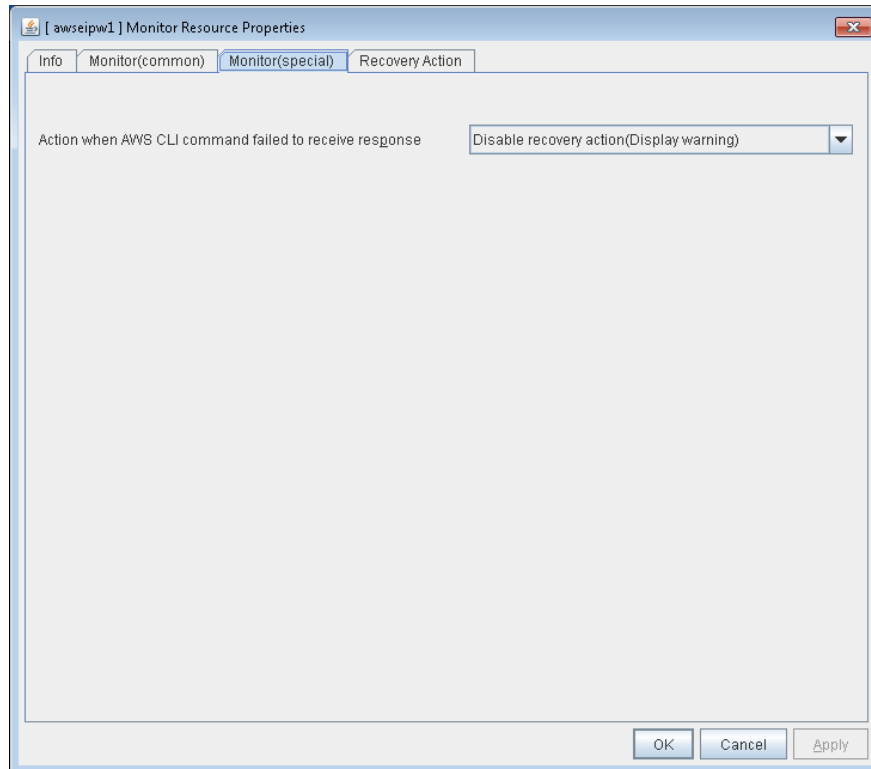

**Action when AWS CLI command failed to receive response**

Specify the action to be taken when acquiring the AWS CLI command response fails.

**Displaying the AWS elastic ip monitor resource property with the WebManager**

1. Start the WebManager.
2. When you click an AWS elastic ip monitor resource  in the tree view, the following information is displayed in the list view.

AWS Elastic IP monitor: awseipw1	
<a href="#">Details</a>	
<div style="display: flex; border-bottom: 1px solid black;"> <div style="border: 1px solid black; padding: 2px 5px;">Common</div> <div style="border: 1px solid black; padding: 2px 5px; margin-left: 5px;">server1</div> <div style="border: 1px solid black; padding: 2px 5px; margin-left: 5px;">server2</div> </div>	
Properties	Value
Comment	
Action when AWS CLI command fai...	Disable recovery action(Display warning)
Status	Normal
Resource Status on Each Server	
Server Name	Status
server1	Offline
server2	Offline

Comment: Comment of the AWS elastic ip monitor resource

Status: Status of the AWS elastic ip monitor resource

Action when AWS CLI command failed to receive response

Action to be taken when acquiring the AWS CLI command response fails

Resource status on the server

Server Name: Server name  
 Status: Status of the monitor resource on the server

When you click **Details**, the following information is displayed in the pop-up dialog box.

Properties	Value
Name	awseipw1
Type	awseipw
Monitor Timing	Activating
Target Resource	awseip1
Interval (sec)	60
Timeout (sec)	100
Do Not Retry at Timeout Occurrence	Off
Do Not Execute Recovery Action at Timeout Occurrence	Off
Retry Count	1
Final Action	No operation
Execute Script Before Reactivation	Off
Execute Script Before Failover	Off
Execute Script before Final Action	Off
Recovery Target	awseip1
Recovery Target Type	Resource
Recovery Script Threshold	0
Reactivation Threshold	3
Failover Threshold	1
Wait Time to Start Monitoring (sec)	0
Nice Value	0
Monitor Suspend Possibility	Possible
Dummy Failure Possibility	Impossible
Collect Dump at Timeout Occurrence	Off
Run Migration Before Run Failover	Off

Name: AWS elastic ip monitor resource name  
 Type: Monitor resource type  
 Monitor Timing: Timing to start monitoring of the monitor resource  
 Target Resource: Resource to be monitored  
 Interval (sec): Interval at which to check the state of the monitor target (in seconds)  
 Timeout (sec): Timeout for monitoring (in seconds)  
 Do Not Retry at Timeout Occurrence: Whether or not to retry when timeout occurs  
 Do Not Execute Recovery Action at Timeout Occurrence: Whether or not to execute recovery action when timeout occurs  
 Retry Count: Number of retries after the detection of an error in the monitor target at which the monitor resource is judged to be in error  
 Final Action: Final action upon deactivation failure  
 Execute Script before Reactivation: Whether or not the pre-reactivation script is executed upon deactivation failure  
 Execute Script before Failover: Whether or not pre-failover script is executed upon deactivation failure  
 Execute Script before Final Action: Whether or not script is executed upon deactivation failure  
 Recovery Target: Name of the target to be recovered when an error is detected  
 Recovery Target Type: Type of target to be recovered when an error is detected  
 Recovery Script Threshold: Number of times the recovery script is executed upon the detection of an error  
 Reactivation Threshold: Number of reactivations to be made upon the detection of an error  
 Failover Threshold: Number of failovers to be made upon the detection of an error  
 Wait Time to Start Monitoring (sec): Time to wait before starting monitoring (in seconds)  
 Nice value: Monitor resource nice value

Monitor Suspended Possibility:	Possibility of suspending monitoring
Dummy Failure Possibility:	Possibility of a dummy failure
Collect Dump at Timeout Occurrence:	Whether or not to collect a dump of the monitor process when a timeout occurs
Run Migration Before Run Failover:	Whether or not to run migration before running failover

## Understanding AWS virtual ip monitor resources

For VIP control, AWS virtual ip monitor resources confirm the existence of VIPs and the soundness of VPC routing by using the OS API and AWS CLI commands.

AWS CLI command is executed for AWS virtual ip monitor resources while monitoring to check the route table information.

### Notes on AWS virtual ip monitor resources

- ◆ AWS virtual ip monitor resources are automatically created when AWS virtual ip resources are added. A single AWS virtual ip monitor resource is automatically created for a single AWS virtual ip resource.
- ◆ See "Setting up AWS virtual ip resources" in "Notes when creating EXPRESSCLUSTER configuration data" in Chapter 5, "Notes and Restrictions" in the *Getting Started Guide*.

### Applying environment variables to AWS CLI run from the AWS virtual ip monitor resource

See "Applying environment variables to AWS CLI run from the AWS virtual ip resource" in this guide

### Displaying and changing the AWS virtual ip monitor resource details

1. In the tree view shown on the left pane of the Builder, click the **Monitors** icon.
2. A list of monitor resources is shown in the table view on the right side of the screen. Right-click the target AWS virtual ip monitor resource, and click **Properties**, and then click the **Monitor(special)** tab.
3. On the **Monitor(special)** tab, you can see and/or change the detailed settings as described below.



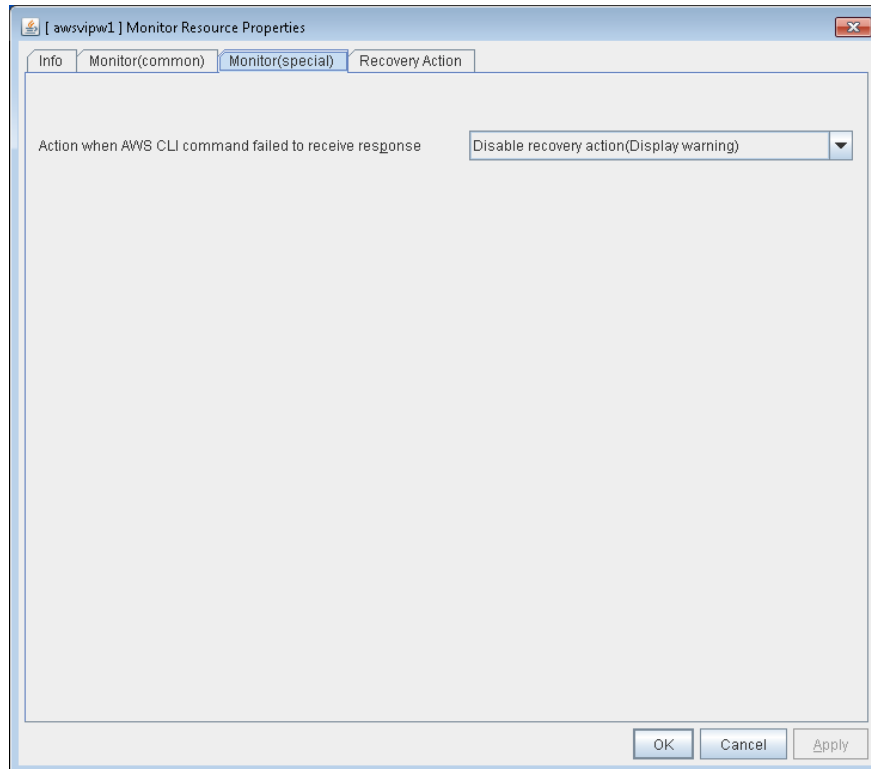

**Action when AWS CLI command failed to receive response**

Specify the action to be taken when acquiring the AWS CLI command response fails. When **Disable recovery action** is selected, a failure in the AWS CLI command (such as timeout or a credential error) is not detected even if the entry of the route table has an error. Therefore, it is recommended to select **Disable recovery action(Display warning)**.

**Displaying the AWS virtual ip monitor resource property with the WebManager**

1. Start the WebManager.
2. When you click an AWS virtual ip monitor resource object  in the tree view, the following information is displayed in the list view.

AWS Virtual IP monitor: awsvipw1		Details
Common server1 server2		
Properties	Value	
Comment		
Action when AWS CLI comma...	Disable recovery action(Display warning)	
Status	Normal	
Resource Status on Each Server		
Server Name	Status	
server1	Offline	
server2	Offline	

Comment: Comment of the AWS virtual ip monitor resource  
 Status: Status of the AWS virtual ip monitor resource  
 Action when AWS CLI command failed to receive response

Action to be taken when acquiring the AWS CLI command response fails

Resource status on the server

Server Name: Server name  
 Status: Status of the monitor resource on the server

When you click **Details**, the following information is displayed in the pop-up dialog box.

Properties	Value
Name	awsvipw1
Type	awsvipw
Monitor Timing	Activating
Target Resource	awsvip1
Interval (sec)	60
Timeout (sec)	100
Do Not Retry at Timeout Occurrence	Off
Do Not Execute Recovery Action at Timeout Occurrence	Off
Retry Count	1
Final Action	No operation
Execute Script Before Reactivation	Off
Execute Script Before Failover	Off
Execute Script before Final Action	Off
Recovery Target	awsvip1
Recovery Target Type	Resource
Recovery Script Threshold	0
Reactivation Threshold	3
Failover Threshold	1
Wait Time to Start Monitoring (sec)	0
Nice Value	0
Monitor Suspend Possibility	Possible
Dummy Failure Possibility	Impossible
Collect Dump at Timeout Occurrence	Off
Run Migration Before Run Failover	Off

Name: AWS virtual ip monitor resource name  
 Type: Monitor resource type  
 Monitor Timing: Timing to start monitoring of the monitor resource  
 Target Resource: Resource to be monitored  
 Interval (sec): Interval at which to check the state of the monitor target (in seconds)  
 Timeout (sec): Timeout for monitoring (in seconds)  
 Do Not Retry at Timeout Occurrence: Whether or not to retry when timeout occurs  
 Do Not Execute Recovery Action at Timeout Occurrence: Whether or not to execute recovery action when timeout occurs  
 Retry Count: Number of retries after the detection of an error in the monitor target at which the monitor resource is judged to be in error  
 Final Action: Final action upon deactivation failure  
 Execute Script before Reactivation: Whether or not the pre-reactivation script is executed upon deactivation failure  
 Execute Script before Failover: Whether or not pre-failover script is executed upon deactivation failure  
 Execute Script before Final Action: Whether or not script is executed upon deactivation failure  
 Recovery Target: Name of the target to be recovered when an error is detected  
 Recovery Target Type: Type of target to be recovered when an error is detected  
 Recovery Script Threshold: Number of times the recovery script is executed upon the detection of an error  
 Reactivation Threshold: Number of reactivations to be made upon the detection of an error

Failover Threshold:	Number of failovers to be made upon the detection of an error
Wait Time to Start Monitoring (sec):	Time to wait before starting monitoring (in seconds)
Nice value:	Monitor resource nice value
Monitor Suspended Possibility:	Possibility of suspending monitoring
Dummy Failure Possibility:	Possibility of a dummy failure
Collect Dump at Timeout Occurrence:	Whether or not to collect a dump of the monitor process when a timeout occurs
Run Migration Before Run Failover:	Whether or not to run migration before running failover

## Understanding AWS AZ monitor resources

AWS AZ monitor resources monitor the soundness of the AZ to which each server belongs, by using the AWS CLI command.

When the AZ status obtained by using AWS CLI command is anything other than “available”, it causes an error.

### Notes on AWS AZ monitor resources

- ◆ When monitoring an AZ, create a single AWS AZ monitor resource.
- ◆ See "Setting up AWS elastic ip resources" and "Setting up AWS virtual ip resources" in "Notes when creating EXPRESSCLUSTER configuration data" in Chapter 5, "Notes and Restrictions" in the *Getting Started Guide*.

### Applying environment variables to AWS CLI run from the AWS AZ monitor resource

See “Applying environment variables to AWS CLI run from the AWS virtual ip resource” in this guide.

### Displaying and changing the AWS AZ monitor resource details

1. In the tree view shown on the left pane of the Builder, click the **Monitors** icon
2. A list of monitor resources is shown in the table view on the right side of the screen. Right-click the target AWS AZ monitor resource, and click **Properties**, and then click the **Monitor(special)** tab.
3. On the **Monitor(special)** tab, you can see and/or change the detailed settings as described below.

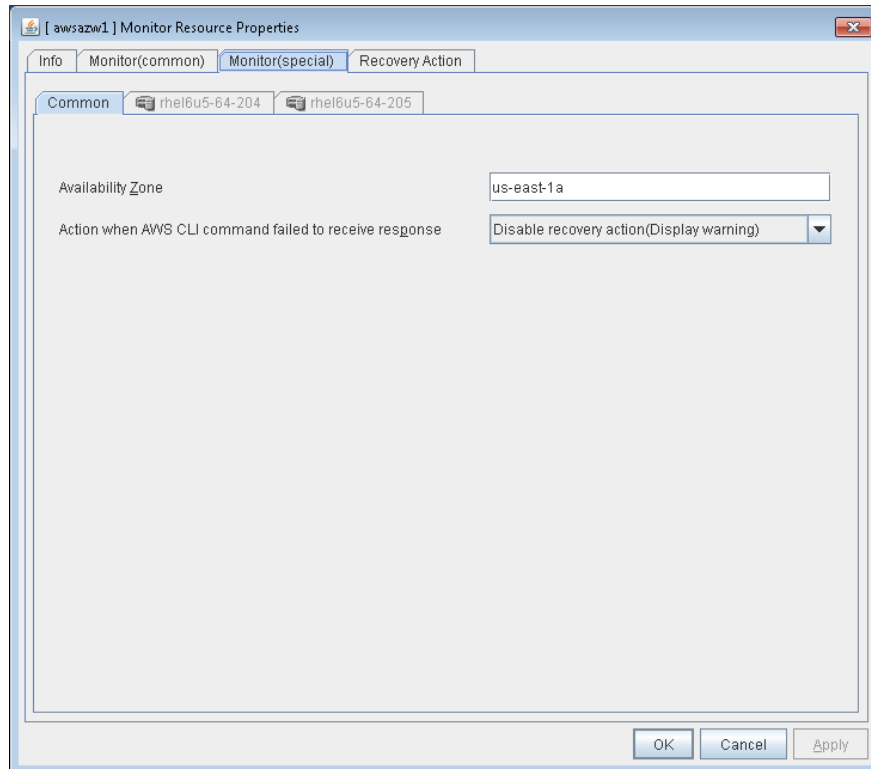

**Availability Zone** (within 45 bytes)

Specify the availability zone in which to perform monitoring.

**Action when AWS CLI command failed to receive response**

Specify the action to be taken when acquiring the AWS CLI command response fails.

## Displaying the property of an AWS AZ monitor resource with the WebManager

1. Start the WebManager.
2. When you click an AWS AZ monitor resource object  in the tree view, the following information is displayed in the list view.

AWS AZ monitor: awsazw1		Details	
Common		server1	server2
Properties	Value		
Comment			
Availability Zone	us-east-1a		
Action when AWS CLI comma...	Disable recovery action(Display warning)		
Status	Normal		
Resource Status on Each Server			
Server Name	Status		
server1	Normal		
server2	Normal		

Comment: Comment of the AWS AZ monitor resource  
 Status: Status of the AWS AZ monitor resource  
 Availability Zone: Availability zone

Action when AWS CLI command failed to receive response  
 Action to be taken when acquiring the AWS CLI command response fails.

Server Name: Server name  
 Status: Status of the monitor resource on the server

When you click Details, the following information is displayed in the pop-up dialog box.

Properties	Value
Name	awsazw1
Type	awsazw
Monitor Timing	Always
Target Resource	
Interval (sec)	60
Timeout (sec)	100
Do Not Retry at Timeout Occurrence	Off
Do Not Execute Recovery Action at Timeout Occurrence	Off
Retry Count	1
Final Action	No operation
Execute Script Before Reactivation	Off
Execute Script Before Failover	Off
Execute Script before Final Action	Off
Recovery Target	LocalServer
Recovery Target Type	Itself
Recovery Script Threshold	0
Reactivation Threshold	0
Failover Threshold	1
Wait Time to Start Monitoring (sec)	0
Nice Value	0
Monitor Suspend Possibility	Possible
Dummy Failure Possibility	Impossible
Collect Dump at Timeout Occurrence	Off
Run Migration Before Run Failover	Off

Name: AWS AZ monitor resource name  
 Type: Monitor resource type  
 Monitor Timing: Timing to start monitoring  
 Target Resource: Resource to be monitored  
 Interval (sec): Interval between monitoring (in seconds)  
 Timeout (sec): Timeout for monitoring (in seconds)  
 Do Not Retry at Timeout Occurrence: Whether or not to retry when timeout occurs  
 Do Not Execute Recovery Action at Timeout Occurrence: Whether or not to execute recovery action when timeout occurs  
 Retry Count: The number of retries to be made from detection of an error in the monitor target to establish the error as an error  
 Final Action: Final action at detection of an error  
 Execute Script before Reactivation: Whether the pre-reactivation script is executed upon the detection of an error  
 Execute Script before Failover: Whether the pre-failover script is executed upon the detection of an error  
 Execute Script before Final Action: Whether the pre-final-action script is executed upon the detection of an error  
 Recovery Target: Target to be recovered when an error is detected  
 Recovery Target Type: Type of target to be recovered when an error is detected  
 Recovery Script Threshold: The number of times the recovery script is executed upon the detection of an error

Reactivation Threshold:	The number of reactivations to be made at detection of an error
Failover Threshold:	The number of failovers to be made at detection of an error
Wait Time to Start Monitoring (sec):	Time to wait before starting monitoring (in seconds)
Nice Value:	Monitor resource nice value
Monitor Suspend Possibility:	Possibility of suspending monitoring
Dummy Failure Possibility:	Possibility of Dummy Failure
Collect Dump at Timeout Occurrence:	Whether or not dump of monitor process is collected when timeout occurs
Run Migration Before Run Failover:	Whether or not migration is run before running failover

## Understanding Azure probe port monitor resources

Azure probe port monitor resources perform alive monitoring on a probe port control process that starts when Azure probe port resources are active on the node on which the Azure probe port resources are active. If the process does not start normally, a monitoring error occurs.

### Notes on Azure probe port monitor resources

- ◆ Azure probe port resources are automatically created when Azure probe port resources are added. One Azure probe port monitor resource is automatically created per Azure probe port resource.
- ◆ In Azure probe port monitor resources, I will monitor the occurrence of probe standby timeout on the Azure probe port resources. Therefore, **Interval** of Azure probe port monitor resource, than the value of the set in the Azure probe port resources monitored **Probe Wait Timeout**, you need to set a large value.
- ◆ See “Azure probe port resource settings” on “Notes when creating EXPRESSCLUSTER configuration data” in Chapter 5, “Notes and Restrictions” of the *Getting Started Guide*.

### Displaying and changing the details of Azure probe port monitor resources

1. In the tree view shown on the left pane of the Builder, click the **Monitors** icon.
2. The list of group resources is shown in the table view on the right side of the screen. Right-click the desired Azure probe port monitor resource name. Then click **Properties** and select the **Monitor(special)** tab.
3. On the **Monitor(special)** tab, you can see and/or change the monitor settings by following the description below.



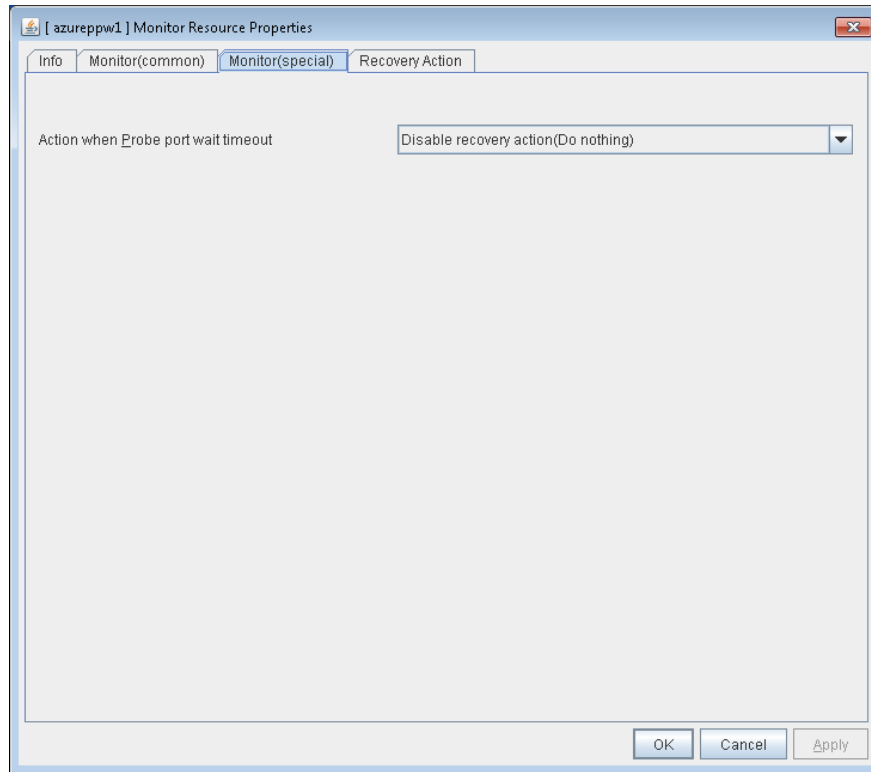

**Action when Probe port wait timeout**

Specify the recovery action to be taken when a probe port wait timeout occurs in Azure probe port resources.

**Displaying the Azure probe port monitor resource properties with the WebManager**

1. Start the WebManager.
2. When you click an Azure probe port monitor  in the tree view, the following information is displayed in the list view.

Azure probe port monitor: azureppw1		Details	
Common		server1	server2
Properties	Value		
Comment			
Action when Probe port wait ti...	Disable recovery action(Do nothing)		
Status	Normal		
Resource Status on Each Server			
Server Name	Status		
server1	Offline		
server2	Offline		

Comment: Comment on the Azure probe port monitor resource  
 Status: Azure probe port monitor resource status  
 Action when Probe port wait timeout: Action to be taken when a timeout occurs.

Server Name: Server name  
 Status: Status of the monitor resource on the server

When you click Details, the following information is displayed in the pop-up dialog box:

Properties	Value
Name	azureppw1
Type	azureppw
Monitor Timing	Activating
Target Resource	azurepp1
Interval (sec)	60
Timeout (sec)	100
Do Not Retry at Timeout Occurrence	Off
Do Not Execute Recovery Action at Timeout Occurrence	Off
Retry Count	1
Final Action	No operation
Execute Script Before Reactivation	Off
Execute Script Before Failover	Off
Execute Script before Final Action	Off
Recovery Target	azurepp1
Recovery Target Type	Resource
Recovery Script Threshold	0
Reactivation Threshold	3
Failover Threshold	1
Wait Time to Start Monitoring (sec)	0
Nice Value	0
Monitor Suspend Possibility	Possible
Dummy Failure Possibility	Impossible
Collect Dump at Timeout Occurrence	Off
Run Migration Before Run Failover	Off

Name:	Azure probe port monitor resource name
Type:	Monitor resource type
Monitor Timing:	Timing to start monitoring
Target Resource:	Target to be monitored
Interval (sec):	Interval between monitoring (in seconds)
Timeout (sec):	Timeout for monitoring (in seconds)
Do Not Retry at Timeout Occurrence:	Whether or not to retry when timeout occurs
Do Not Execute Recovery Action at Timeout Occurrence:	Whether or not to execute recovery action when timeout occurs
Retry Count:	The number of retries to be made from detection of an error in the monitor target to establish the error as an error
Final Action:	Final action at detection of an error
Execute Script before Reactivation:	Whether the pre-reactivation script is executed upon the detection of an error
Execute Script before Failover:	Whether the pre-failover script is executed upon the detection of an error
Execute Script before Final Action:	Whether the pre-final-action script is executed upon the detection of an error
Recovery Target:	Target to be recovered when an error is detected
Recovery Target Type:	Type of target to be recovered when an error is detected
Recovery Script Threshold:	The number of times the recovery script is executed upon the detection of an error
Reactivation Threshold:	The number of reactivations to be made at detection of an error
Failover Threshold:	The number of failovers to be made at detection of an error
Wait Time to Start Monitoring (sec):	Time to wait before starting monitoring (in seconds)
Nice Value:	Monitor resource nice value
Monitor Suspended Possibility:	Possibility of suspending monitoring

Dummy Failure Possibility:	Possibility of Dummy Failure
Collect Dump at Timeout Occurrence:	Whether or not dump of monitor process is collected when timeout occurs
Run Migration Before Run Failover:	Whether or not migration is run before running failover

## Understanding Azure load balance monitor resources

Azure load balance monitor resources monitor to see if a port with the same port number as that of the probe port has been open on the node on which the Azure probe port resources are not active.

### Note on Azure load balance monitor resources

- ◆ Azure load balance monitor resources are automatically created when Azure probe port resources are added. One Azure load balance monitor resource is automatically created per Azure probe port resource.
- ◆ See “Setting up Azure probe port resources” on “Notes when creating EXPRESSCLUSTER configuration data” in Chapter 5, “Notes and Restrictions” of the *Getting Started Guide*.
- ◆ See “Setting up Azure load balance monitor resources” on “Notes when creating EXPRESSCLUSTER configuration data” in Chapter 5, “Notes and Restrictions” of the *Getting Started Guide*.

### Displaying and changing the details of Azure load balance monitor resources

1. In the tree view shown on the left pane of the Builder, click the **Monitors** icon.
2. The list of group resources is shown in the table view on the right side of the screen. Right-click the desired Azure load balance monitor resource name. Then click **Properties** and select the **Monitor(special)** tab.
3. On the **Monitor(special)** tab, you can see and/or change the monitor settings by following the description below.

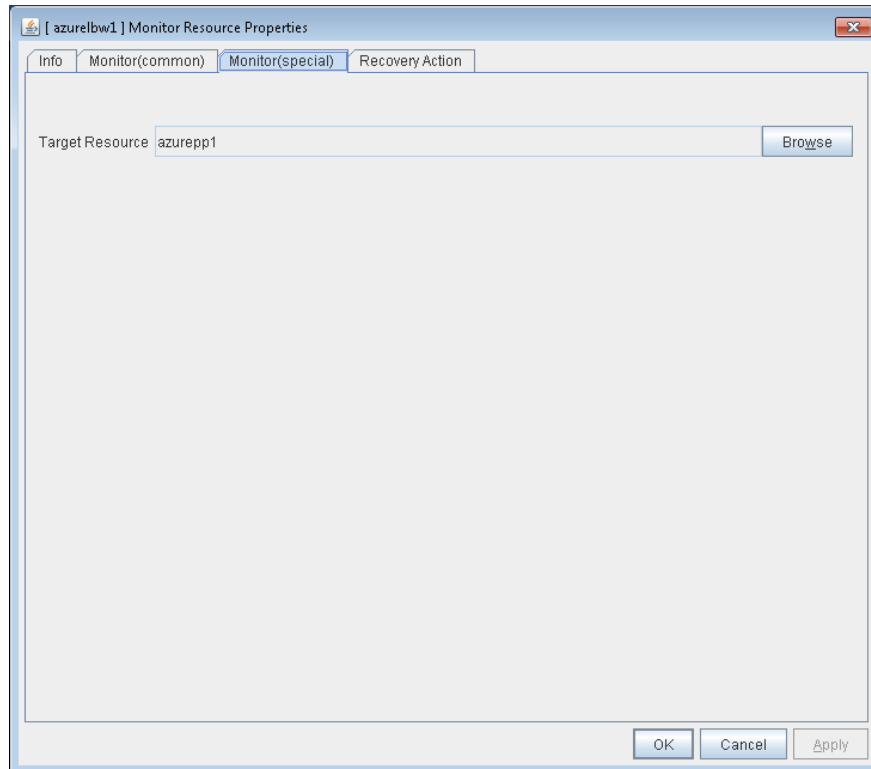

**Target Resource**

Set Resource to be monitored

**Displaying the Azure load balance monitor resource properties with the WebManager**

1. Start the WebManager.
2. When you click an Azure load balance monitor  in the tree view, the following information is displayed in the list view.

Azure load balance monitor: azurelbw1		Details	
Common		server1	server2
Properties	Value		
Comment			
Monitor Target	azurepp1		
Status	Normal		
Resource Status on Each Server			
Server Name	Status		
server1	Normal		
server2	Normal		

Comment: Comment on the Azure load balance monitor resource  
 Monitor Target: Resource to be monitored  
 Status: Azure load balance monitor resource status

Server Name: Server name  
 Status: Status of the monitor resource on the server

When you click Details, the following information is displayed in the pop-up dialog box:

Properties	Value
Name	azurelbw1
Type	azurelbw
Monitor Timing	Always
Target Resource	
Interval (sec)	60
Timeout (sec)	100
Do Not Retry at Timeout Occurrence	Off
Do Not Execute Recovery Action at Timeout Occurrence	Off
Retry Count	1
Final Action	No operation
Execute Script Before Reactivation	Off
Execute Script Before Failover	Off
Execute Script before Final Action	Off
Recovery Target	azurepp1
Recovery Target Type	Resource
Recovery Script Threshold	0
Reactivation Threshold	3
Failover Threshold	1
Wait Time to Start Monitoring (sec)	0
Nice Value	0
Monitor Suspend Possibility	Possible
Dummy Failure Possibility	Impossible
Collect Dump at Timeout Occurrence	Off
Run Migration Before Run Failover	Off

Name:	Azure load balance resource name
Type:	Monitor resource type
Monitor Timing:	Timing to start monitoring
Target Resource:	Resource to be monitored
Interval (sec):	Interval between monitoring (in seconds)
Timeout (sec):	Timeout for monitoring (in seconds)
Do Not Retry at Timeout Occurrence:	Whether or not to retry when timeout occurs
Do Not Execute Recovery Action at Timeout Occurrence:	Whether or not to execute recovery action when timeout occurs
Retry Count:	The number of retries to be made from detection of an error in the monitor target to establish the error as an error
Final Action	Final action at detection of an error
Execute Script before Reactivation:	Whether the pre-reactivation script is executed upon the detection of an error
Execute Script before Failover:	Whether the pre-failover script is executed upon the detection of an error
Execute Script before Final Action:	Whether the pre-final-action script is executed upon the detection of an error
Recovery Target:	Target to be recovered when an error is detected
Recovery Target Type:	Type of target to be recovered when an error is detected
Recovery Script Threshold:	The number of times the recovery script is executed upon the detection of an error
Reactivation Threshold:	The number of reactivations to be made at detection of an error
Failover Threshold:	The number of failovers to be made at detection of an error
Wait Time to Start Monitoring (sec):	Time to wait before starting monitoring (in seconds)
Nice Value:	Monitor resource nice value
Monitor Suspend Possibility:	Possibility of suspending monitoring

Dummy Failure Possibility:	Possibility of Dummy Failure
Collect Dump at Timeout Occurrence:	Whether or not dump of monitor process is collected when timeout occurs
Run Migration Before Run Failover:	Whether or not migration is run before running failover





# Chapter 6      Heartbeat resources details

This chapter provides detailed information on heartbeat resources.

This chapter covers:

- What are heartbeat resources?..... 1206
- Understanding LAN heartbeat resources ..... 1207
- Understanding kernel mode LAN heartbeat resources ..... 1208
- Understanding disk heartbeat resources ..... 1210
- Understanding COM heartbeat resources..... 1214
- Understanding BMC heartbeat resources ..... 1215

## What are heartbeat resources?

A server in a cluster configuration monitors whether the other server is being activated. For this monitoring, heartbeat resources are used.

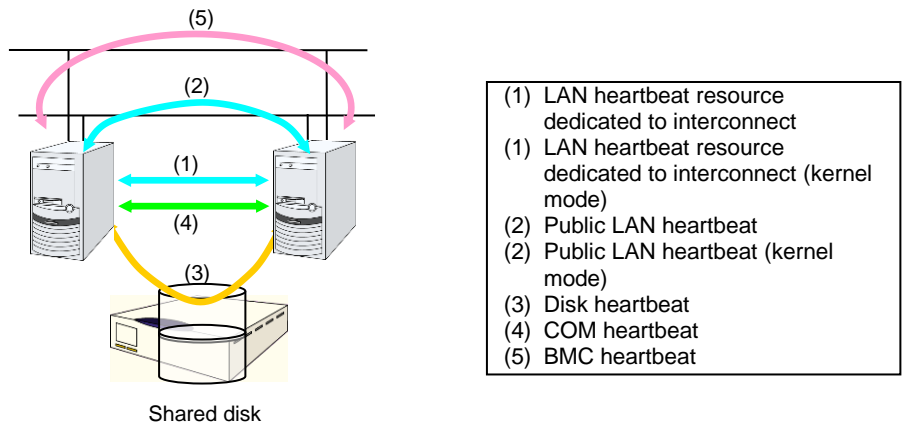

Heartbeat resource name	Abbreviation	Functional overview
LAN heartbeat resource (1)(2)	lanhb	Uses a LAN to monitor if servers are activated. Used for communication within the cluster as well.
Kernel mode LAN heartbeat resource (1)(2)	lankhb	A kernel mode module uses a LAN to monitor if servers are activated.
Disk heartbeat resource (3)	diskhb	Uses a dedicated partition in the shared disk to monitor if servers are activated.
COM heartbeat resource (4)	comhb	Uses a COM cable connecting two servers to monitor if servers are activated.
BMC heartbeat resource (5)	bmchb	Uses BMC to monitor whether servers are activated.

- ◆ At least either one LAN heartbeat resource or one kernel mode LAN heartbeat resource must be configured. It is recommended to set two or more LAN heartbeat resources. It is recommended to set both LAN heartbeat resource and kernel mode LAN heartbeat resource together.
- ◆ When you configure the settings of interfaces for disk heartbeat and COM heartbeat resources, follow the specifications described below.

When a shared disk is used:	[Number of servers: up to 2] In principle, COM interface and disk interface [Number of servers: 3 or more] Disk interface
When a shared disk is not used:	[Number of servers: up to 2] COM interface

# Understanding LAN heartbeat resources

## LAN heartbeat resources

- ◆ You need to set at least one LAN heartbeat resource or kernel mode LAN heartbeat resource. It is recommended to have two or more LAN heartbeat resources; the one dedicated to interconnect and the one shared with interconnect and public.
- ◆ Communication data for alert synchronization is transmitted on an interface that is registered with the interconnect. You should consider network traffic when you configure the settings.

## Displaying the property of a LAN heartbeat resource with the WebManager

1. Start the WebManager.
2. When you click an object for a LAN heartbeat resource, , in the tree view, the following information is displayed in the list view.

LAN Heartbeat Name: lanhb1		Details
Server Name	Status	
server1	Normal	
server2	Normal	

Server Name: Server name  
 Status: Status of the heartbeat resource on the server

When you click **Details**, the following information is displayed in the pop-up dialog box:

LAN Heartbeat Detailed Properties (lanhb1)	
Properties	Value
Name	lanhb1
Type	lanhb
Comment	LAN Heartbeat
Status	Normal
IP Address	192.168.0.1

Name: LAN heartbeat resource name  
 Type: LAN heartbeat resource type  
 Comment: Comment of the LAN heartbeat resource  
 Status: Statuses of all LAN heartbeat resources  
 IP Address: IP address of the LAN used for LAN heartbeat

## Understanding kernel mode LAN heartbeat resources

### Environment where the kernel mode LAN heartbeat resources works

---

**Note:**

This function is dependent on the distribution and kernel version. Refer to “Software Supported distributions and kernel versions” in Chapter 3, “Installation requirements for EXPRESSCLUSTER” in the *Getting Started Guide* before you configure the settings.

---

### The settings of the kernel mode LAN heartbeat resources

With the kernel mode driver module, kernel mode LAN heartbeat resource offer similar functions that LAN heartbeats provide. The kernel mode LAN heartbeat resources have the following features.

- ◆ Kernel mode LAN heartbeat resource is less likely to be impacted by load of OS because it uses the kernel mode driver. This reduces the misinterpreting disconnect of interconnection.
- ◆ When used with the keepalive settings to watch user-mode monitor resource, the kernel mode LAN heartbeat resource allows reset to be recorded in other servers when the user mode stalling is detected.

### kernel mode LAN heartbeat resources

It is recommended to specify two or more kernel mode LAN heartbeat resources; the one dedicated to interconnect and the one shared with interconnect and public.

## Displaying the property of kernel mode LAN heartbeat resources with the WebManager

1. Start the WebManager.
2. When you click an object for a kernel mode LAN heartbeat resources, , in the tree view, the following information is displayed in the list view.

Kernel Mode LAN Heartbeat Name: lankhb1		Details
Server Name	Status	
server1	Normal	
server2	Normal	

Server Name: Server name  
 Status: Status of the heartbeat resource status on the server

When you click **Details**, the following information is displayed in the pop-up dialog box:

Properties	Value
Name	lankhb1
Type	lankhb
Comment	Kernel Mode LAN Heartbeat
Status	Normal
IP Address	192.168.0.1

Name: Kernel mode LAN heartbeat resource name  
 Type: Kernel mode LAN heartbeat resource type  
 Comment: Comment of the Kernel mode LAN heartbeat resource  
 Status: Status of all kernel mode LAN heartbeat resources  
 IP Address: IP address of the LAN used for kernel mode LAN heartbeat

# Understanding disk heartbeat resources

## Setting the disk heartbeat resources

To use a heartbeat resource, you need to have the following settings.

Allocate a dedicated partition on the shared disk. (You do not need to create any file system.)

Configure settings that allow all servers to access the dedicated partition on the shared disk by the same device name.

When a disk heartbeat resource is being used, it can be checked if other servers are active even if the network is disconnected.

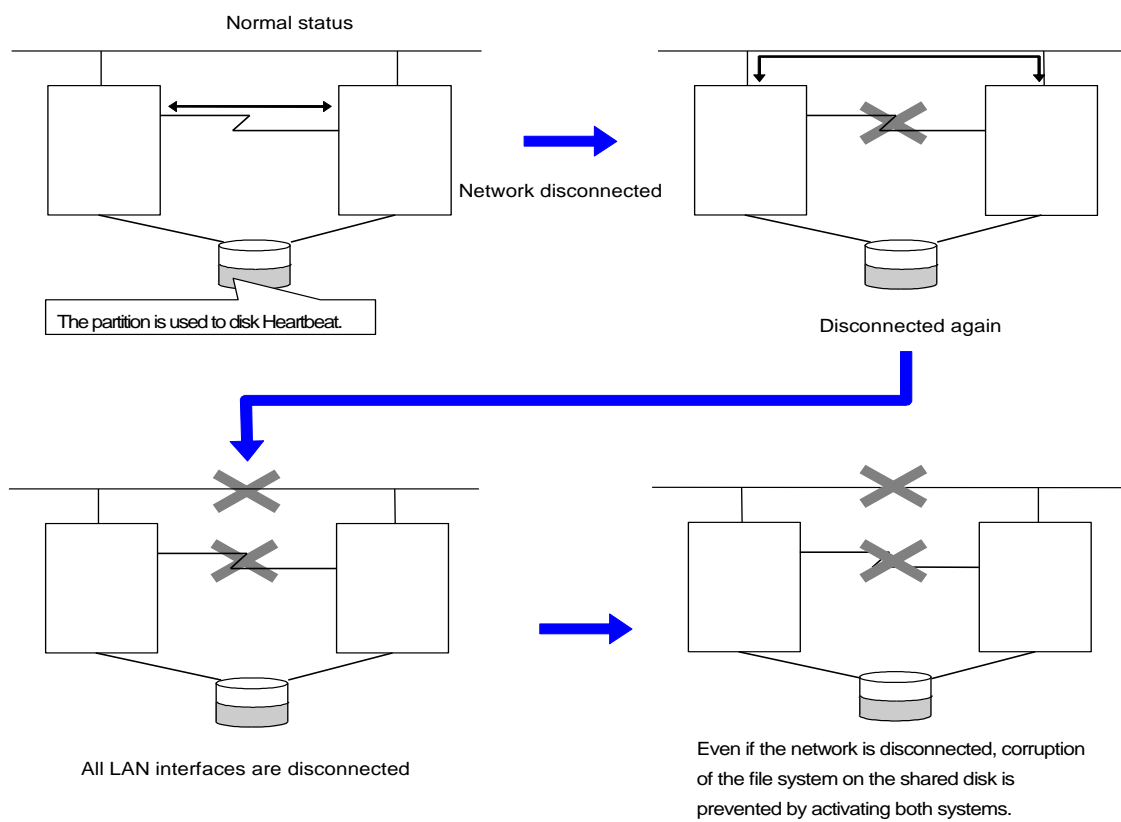

If the cluster consists of three or more servers, you can have a configuration using a disk heartbeat resource as below. You can configure the settings that allow usage of the disk heartbeat resource only among the servers in the cluster using the shared disk.

For details, see “Cluster properties Interconnect tab” in Chapter 2, “Functions of the Builder” in this guide.

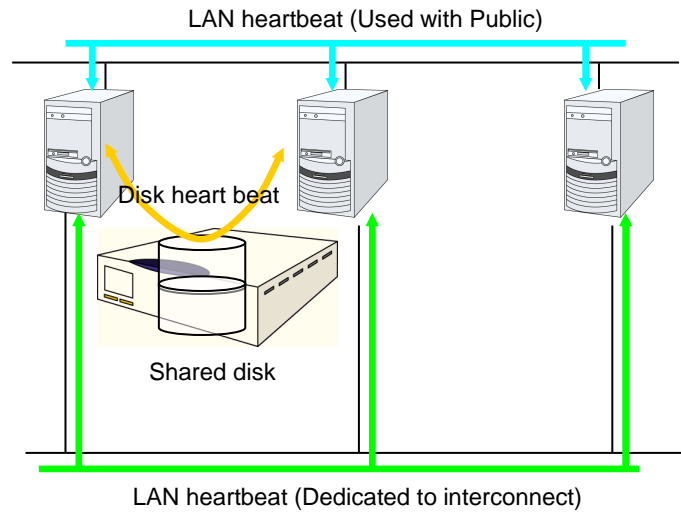

## Disk heartbeat resources

It is recommended to use both a LAN heartbeat resource and a disk heartbeat resource when you use a shared disk.

It is recommended to use one or two disk heartbeat resources in the cluster even if you are using two or more LUNs. You should consider how heavy the disk is loaded when you configure the settings because a disk heartbeat resource reads and/or writes to the disk every heartbeat interval.

In each LUN, allocate a partition dedicated to a disk heartbeat. LUNs that do not use a disk heartbeat should also have a dummy partition because the file system can be damaged if device names are moved due to disk failure or other causes.

Partitions dedicated to disk heartbeat should have the same number across all the LUNs.

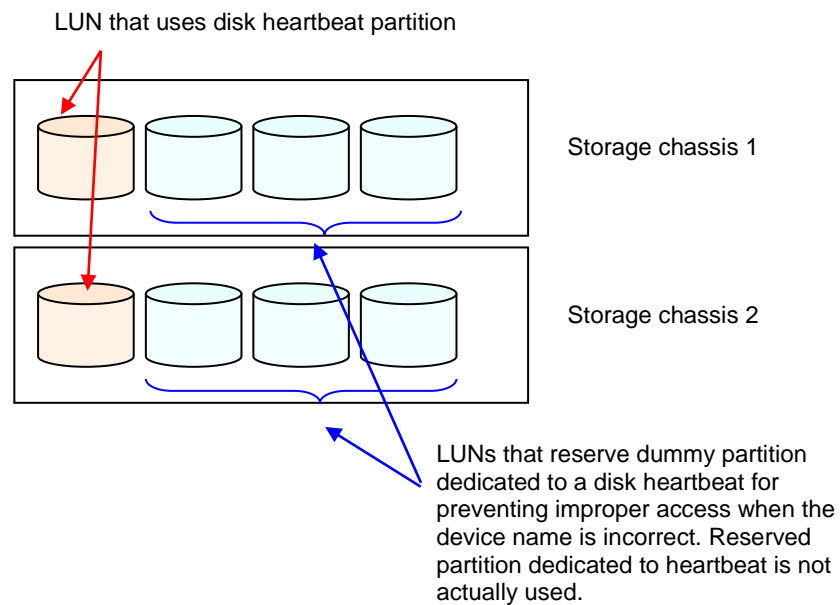

Do not register to storage pool.



## Displaying the property of the disk heartbeat resource with the WebManager

1. Start the WebManager.
2. When you click an object for a disk heartbeat resource, , in the tree view, the following information is displayed in the list view.

Disk Heartbeat Name: diskhb1		Details
Server Name	Status	
server1	Normal	
server2	Normal	

Server Name:

Server name

Status:

Status of the heartbeat resource on the server

When you click **Details**, the following information is displayed in the pop-up dialog box:

Properties	Value
Name	diskhb1
Type	diskhb
Comment	DISK Heartbeat
Status	Normal
Device Name	/dev/sdc1
RAW Device Name	

Name:

Disk heartbeat resource name

Type:

Disk heartbeat resource type

Comment:

Comment of the disk heartbeat resource

Status:

Status of all disk heartbeat resources

Device Name:

Name of the disk devices used for disk heartbeat

Raw Device Name:

Raw device name dedicated to the disk heartbeat

## Understanding COM heartbeat resources

### Note on COM heartbeat resources

It is recommended to use a COM heartbeat resource if your environments allows. This is because using a COM heartbeat resource prevents activating both systems when the network is disconnected.

### Displaying the property of the COM heartbeat resource with the WebManager

1. Start the WebManager.
2. When you click an object for a COM heartbeat resource,  in the tree view, the following information is displayed in the list view.

COM Heartbeat Name: comhb1		Details
Server Name	Status	
server1	Unused	
server2	Normal	

Server Name: Server name  
 Status: Status of the heartbeat resource on the server

#### Note:

The COM heartbeat resource treats its own status as “Not used,” and does not use as a heartbeat status. The figure above indicates the status when the COM heartbeat resource under Server1 is selected by WebManager. In this case, the status of Server1 is set as “Not used,” and the status of standby Server2 becomes the one of a COM heartbeat resource.

When you click **Details**, the following information is displayed in the pop-up dialog box:

Properties	Value
Name	comhb1
Type	comhb
Comment	COM Heartbeat
Status	Normal
Device Name	/dev/ttyS0

Name: COM heartbeat resource name  
 Type: COM heartbeat resource type  
 Comment: Comment of the COM heartbeat resource  
 Status: Status of the COM heartbeat resource (logical sum of status)  
 Device Name: Name of the COM device used for COM heartbeat

# Understanding BMC heartbeat resources

## Notes on BMC heartbeat resources

BMC heartbeat resources provide functions similar to those of the LAN heartbeat resource. BMC heartbeat resources feature the following:

- ◆ Activation monitoring is performed with the hardware, and therefore is essentially unaffected by the load on the OS and is less likely to incorrectly recognize the disconnection of interconnects.
- ◆ The BMC hardware and firmware must support the BMC heartbeat. For the usable BMC versions, see “Servers supporting Express5800/A1080a or Express5800/A1040a series -related functions” in Chapter 3 in the *Getting Started Guide*.

## Displaying the property of the BMC heartbeat resource with the WebManager

1. Start the WebManager.
2. When you click an object for a BMC heartbeat resource,  in the tree view, the following information is displayed in the list view.

BMC Heartbeat bmchb1		Details
Server Name	Status	
server1	Normal	
server2	Normal	

Server Name:

Server name

Status:

Status of the heartbeat resource on the server

When you click **Details**, the following information is displayed in the pop-up dialog box:

Properties	Value
Name	bmchb1
Type	bmchb
Comment	BMC Heartbeat
Status	Normal
IP Address	192.168.8.1

Name:

BMC heartbeat resource name

Type:

BMC heartbeat resource type

Comment:

Comment on the BMC heartbeat resource

Status:

Status of the BMC heartbeat resource (general)

IP Address:

BMC IP address used for BMC heartbeat check



# Chapter 7      Network partition resolution resources details

This chapter provides detailed information on network partition resolution resources.

This chapter covers:

- Network partitions ..... 1218
- Understanding the network partition resolution resources ..... 1219
- Understanding network partition resolution by PING method ..... 1220
- Not resolving network partition ..... 1222

## Network partitions

Network partitioning, or “Split Brain” syndrome, refers to the status where all communication channels have problems and the network between servers is partitioned.

In a cluster system that is not equipped with solutions for “Split Brain Syndrome,” a failure on a communication channel cannot be distinguished from an error on a server. This can cause data corruption brought by access from multiple servers to the same resource. EXPRESSCLUSTER, on the other hand, uses resources for network partition resolution to distinguish a failure on a server from “Split Brain Syndrome” when a heartbeat from a server is lost. If the lack of heartbeat is determined to be caused by the server’s failing, the system performs a failover by activating each resource and rebooting applications on a server running normally. When the lack of heartbeat is determined to be caused by “Brain Split” syndrome, emergency shutdown is executed because protecting data has higher priority over continuity of the operation.

## Understanding the network partition resolution resources

Servers in a cluster monitor other servers by using heartbeat resources. When all heartbeat resources are disconnected or other server is shut down by a server not in a cluster, the network partition is solved using network partition resolution resources. The following network partition resolution resource is provided.

Network partition resolution resources	Abbreviation	Function Overview
PING network partition resolution resource (PING method)	pingnp	A network partition is solved by determining a server that can communicate using the ping command.

If there is only one available LAN on the configuration, set the PING network partition resolution.

# Understanding network partition resolution by PING method

## Settings of the PING network partition resolution resources

To use PING network partition resolution resources, a device that is always active to receive and respond to the ping command (hereafter described as ping device) is required.

When the heartbeat from another server is lost but the ping device is responding to the ping command, the remote server is down. Failover starts.

If there is no response to the ping command, it is determined that the local server is isolated from the network due to “Split Brain Syndrome,” an action when a network partition occurs is performed.

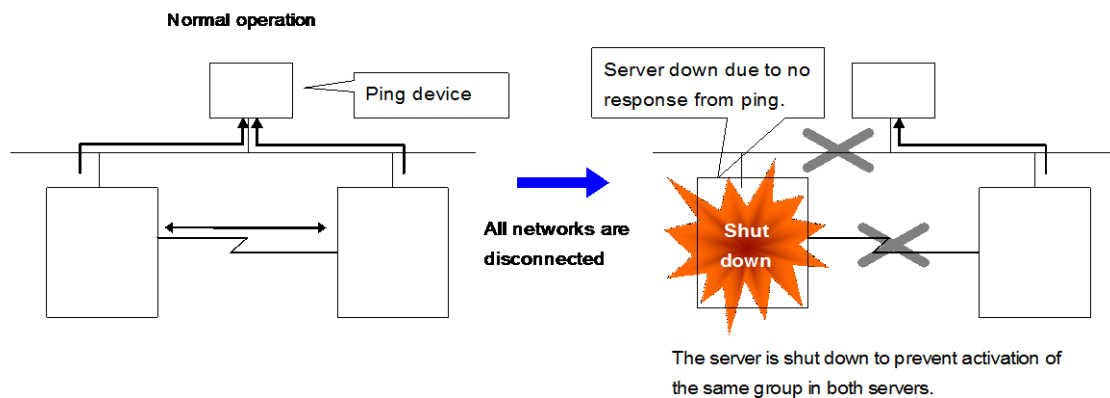

For details, see “Cluster properties NP Resolution tab” in Chapter 2, “Functions of the Builder in this guide.

## Note on PING network partition resolution resource

When using PING network partition resolution resource, specify addresses which can be sent from and received to through one of the interconnect LANs registered in the configuration information.

In case that response to ping command continues not returning on all the all servers before disconnection of the heartbeat due to ping device failure or other reasons, network partition cannot be resolved. If the heartbeat disconnection is detected in this situation, an action when a network partition occurs is performed on all servers.

It is possible to set **Use** or **Do Not Use** for each server. If **Do Not Use** is set incorrectly, NP resolution processing cannot be performed and a double activation may be detected. The following is an example of an incorrect setting in which NP resolution processing cannot be performed.

NP Resolution List				
Type	Ping Target	server1	server2	
Ping	10.0.0.254	Use	Do Not Use	
Ping	10.0.0.254	Do Not Use	Use	



## Displaying the properties of PING network partition resolution resources with the WebManager

1. Start the WebManager.
2. When you click an object for a PING network partition resolution resource  in the tree view, the following information is displayed in the list view.

PING Network Partition Resolution Resource Name: pingnp1		Details
Server Name	Status	
server1	Normal	
server2	Normal	

Server Name: Server name  
 Status: Status of the network partition resource on the given server

When you click **Details**, the following information is displayed in the pop-up dialog box:

Properties	Value
Name	pingnp1
Type	pingnp
Comment	ping resolution
Status	Normal
IP Address List	192.168.0.254
Ping Interval (sec)	5
Ping Timeout (sec)	3
Ping Retry Count	3

Name: Name of the PING network partition resolution resource  
 Type: Type of the PING network partition resolution resource  
 Comment: Comment of the PING network partition resolution resource  
 Status: Status (whole) of the PING network partition resolution resource  
 IP Address List: IP address list of ping device  
 Ping Interval (sec): Interval of the PING network partition resolution resource  
 Ping Timeout (sec): Timeout of the PING network partition resolution resource  
 Ping Retry Count: Retry count of the PING network partition resolution resource

## **Not resolving network partition**

When this method is selected, network partition resolution is not performed. Therefore, if a failure occurs on all the network channels between servers in a cluster, all servers fail over.

# Chapter 8 Information on other settings

This chapter provides the information on the other monitor or notification settings.

This chapter covers:

- Shutdown monitoring ..... 1224
- Bonding ..... 1228
- Forced stop ..... 1232
- Script for forced stop ..... 1235
- Chassis Identify ..... 1237
- Alert Service ..... 1239
- SNMP linkage ..... 1242
- Cluster service automatic startup prohibition after improper stop ..... 1248
- NX7700x series linkage ..... 1249
- Express5800/A1080a or Express5800/A1040a series linkage ..... 1250
- AWS elastic ip resources, AWS virtual ip resources, AWS elastic ip monitor resources, AWS virtual ip monitor resources and AWS AZ monitor resources ..... 1259
- Azure probe port resources, Azure probe port monitor resources, and Azure load balance monitor resources ..... 1260

## Shutdown monitoring

### Shutdown monitoring

In shutdown monitoring, it is monitored if the OS is stalled when cluster or server shutdown is performed by an EXPRESSCLUSTER command.

If the cluster daemon assumes the OS is stalled, forced reset is executed.

### Displaying and changing the shutdown monitoring

#### Performs consistently

Shutdown is monitored. The heartbeat (see chapter 6 “Heartbeat resources details”) timeout must be longer than the time required for the OS to shut down, including the applications exiting. It is recommended that you set **Performs consistently** if you are using shared disks, mirror disks or hybrid disks.

#### Performs only upon the occurrence of a group deactivation failure

Shutdowns are monitored only upon the occurrence of a group deactivation failure. The heartbeat timeout (see Chapter 6 “Heartbeat resources details”) must be longer than the time required for the OS to shut down, including that needed for the applications to quit.

#### Disable

Shutdown is not monitored.

### Shutdown monitoring method

You can select how to monitor shutdown from:

softdog

For this method, set the timer by using the softdog driver.

ipmi

For this method, set the timer by using ipmiutil. If ipmiutil is not installed, you need to install it. For ipmi, see “Understanding user-mode monitor resource” on page 940.

ipmi(High-End Server Option)

This cannot be used.

keepalive

For this method, set the clpkhb and clpka drivers of EXPRESSCLUSTER are used to set the timer.

---

#### Note:

Check the distribution and kernel versions supported by the clpkhb and clpka drivers by referencing “Software Supported distributions and kernel versions” in Chapter 3, “Installation requirements for EXPRESSCLUSTER” in the *Getting Started Guide*.

Check them when applying security patches which are released by a distributor to the operating cluster (when the kernel version is changed).

---

## Setting of SIGTERM

SIGTERM is issued when shutting down the OS. The range of shutdown stall monitoring and what will be performed at successful OS shutdown are determined by the setting, “Enable SIGTERM handler.” When the monitoring method is set to keepalive, what will be performed is the same as when softdog is set.

Monitoring method: softdog

Successful shutdown (when softdog is selected and SIGTERM is enabled)

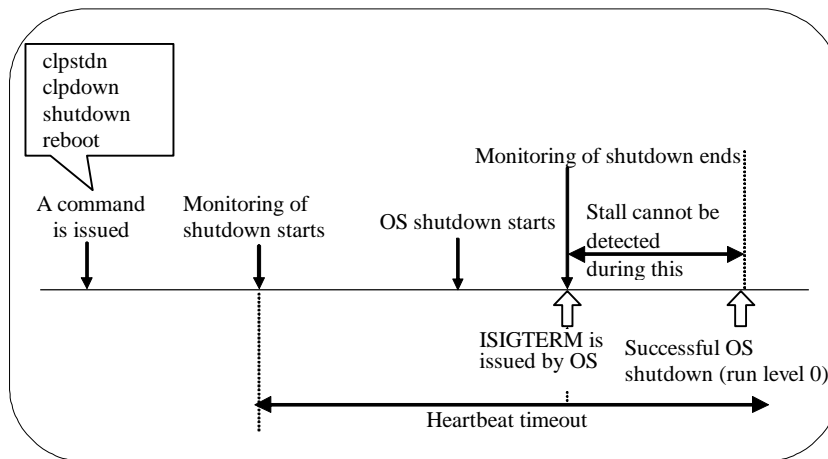

When SIGTERM is enabled, the stalled status cannot be detected because monitoring of the shutdown ends if the OS issues SIGTERM during shutdown.

Successful shutdown (when softdog is selected and SIGTERM is disabled)

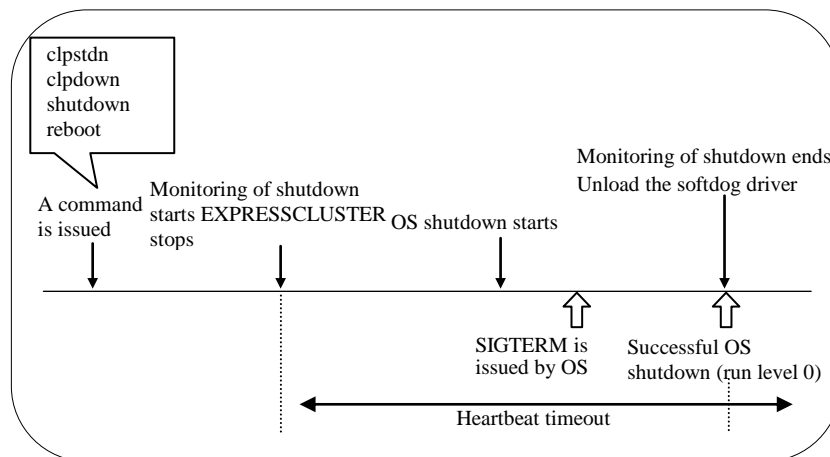

It is recommended to disable SIGTERM if softdog is selected as a method of monitoring.

Monitoring method: ipmi / ipmi(High-End Server Option)

Successful shutdown (when ipmi is selected and SIGTERM is enabled)

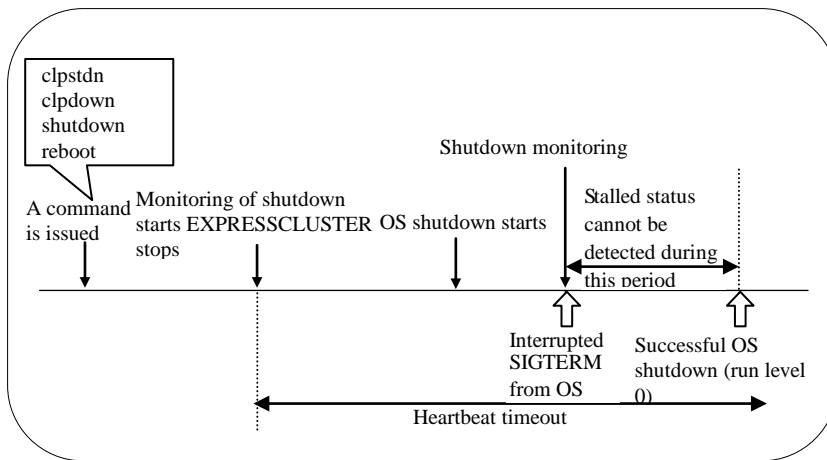

When SIGTERM is enabled, the stalled status cannot be detected because monitoring of the shutdown ends if the OS issues SIGTERM during shutdown.

Successful shutdown (when ipmi is selected and SIGTERM is disabled)

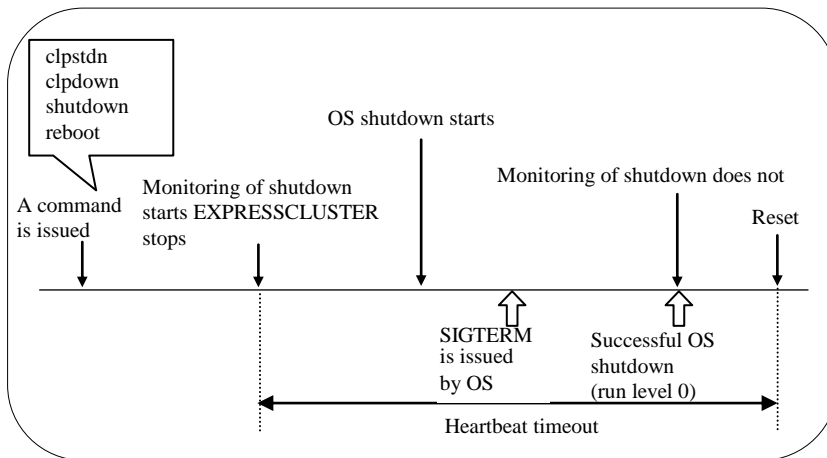

Even if the shutdown is successful without any stalled status, a server is reset by ipmi.

On a server that can be powered off by software, reset is not performed.

It is recommended to enable SIGTERM if ipmi is selected as a method of monitoring.

When a stalled status occurs in OS shutdown.

When a stalled status in shutdown is detected

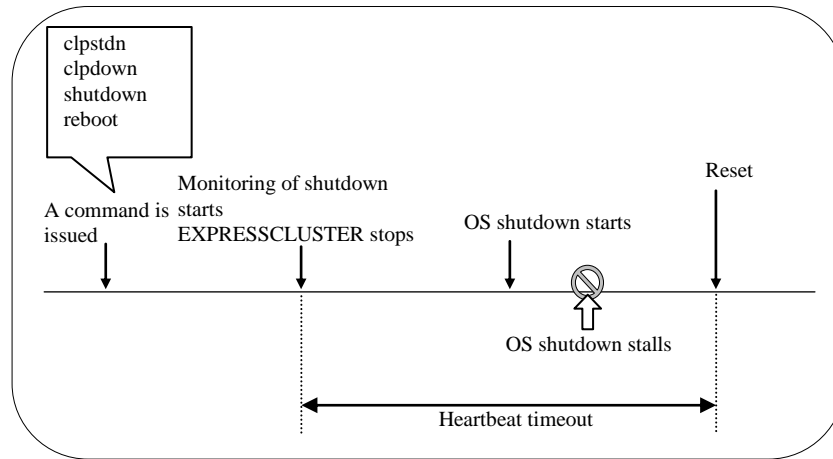

## Using heartbeat timeout

Use the timeout value for shutdown monitoring with the heartbeat timeout value.

## Timeout

Specify the timeout value when the heartbeat timeout value is not used as the timeout value for shutdown monitoring.

A value smaller than the heartbeat timeout value must be specified to prevent both systems from activating when a failover occurs upon detection of a server down.

# Bonding

## Floating IP resource

### Notes

If you specify “active-backup” to bonding mode, the communication may be temporarily lost when switching slave interfaces.

### Bonding setting example

When you configure the settings for FIP resource by the Builder, separate the IP address and bonding device with "%" in **Details** tab of **Properties** as described below.

Example: Setting “bond0” as device name, “192.168.1.3” as IP address

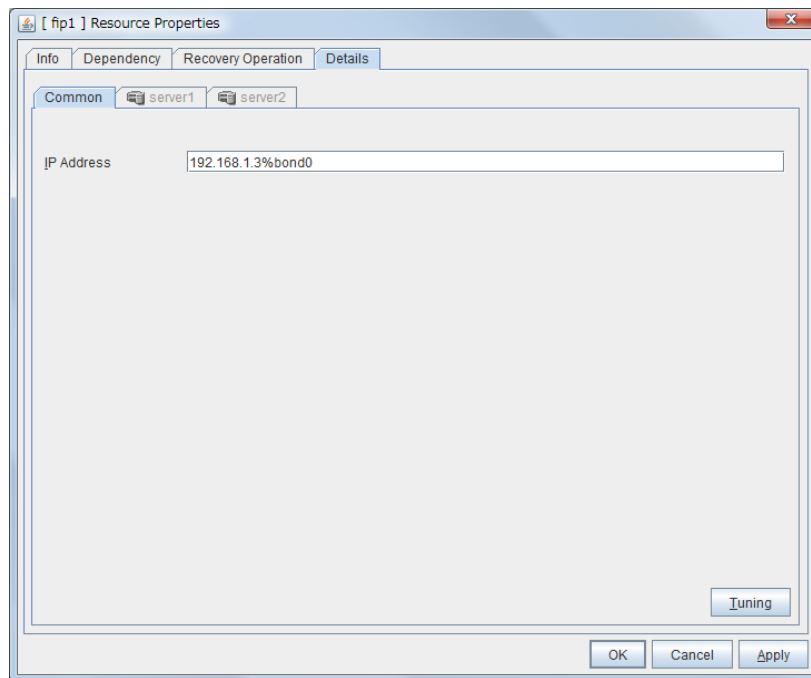

---

### Note:

For interconnection IP address, specify IP addresses only.

---

The following shows example settings to use FIP resource on bonding:

Bonding		
Device	Slave	Mode
bond0	eth0	- active-backup(1)
	eth1	- balance-tlb(5)
bond0	eth0	- active-backup(1)
	eth1	- balance-tlb(5)



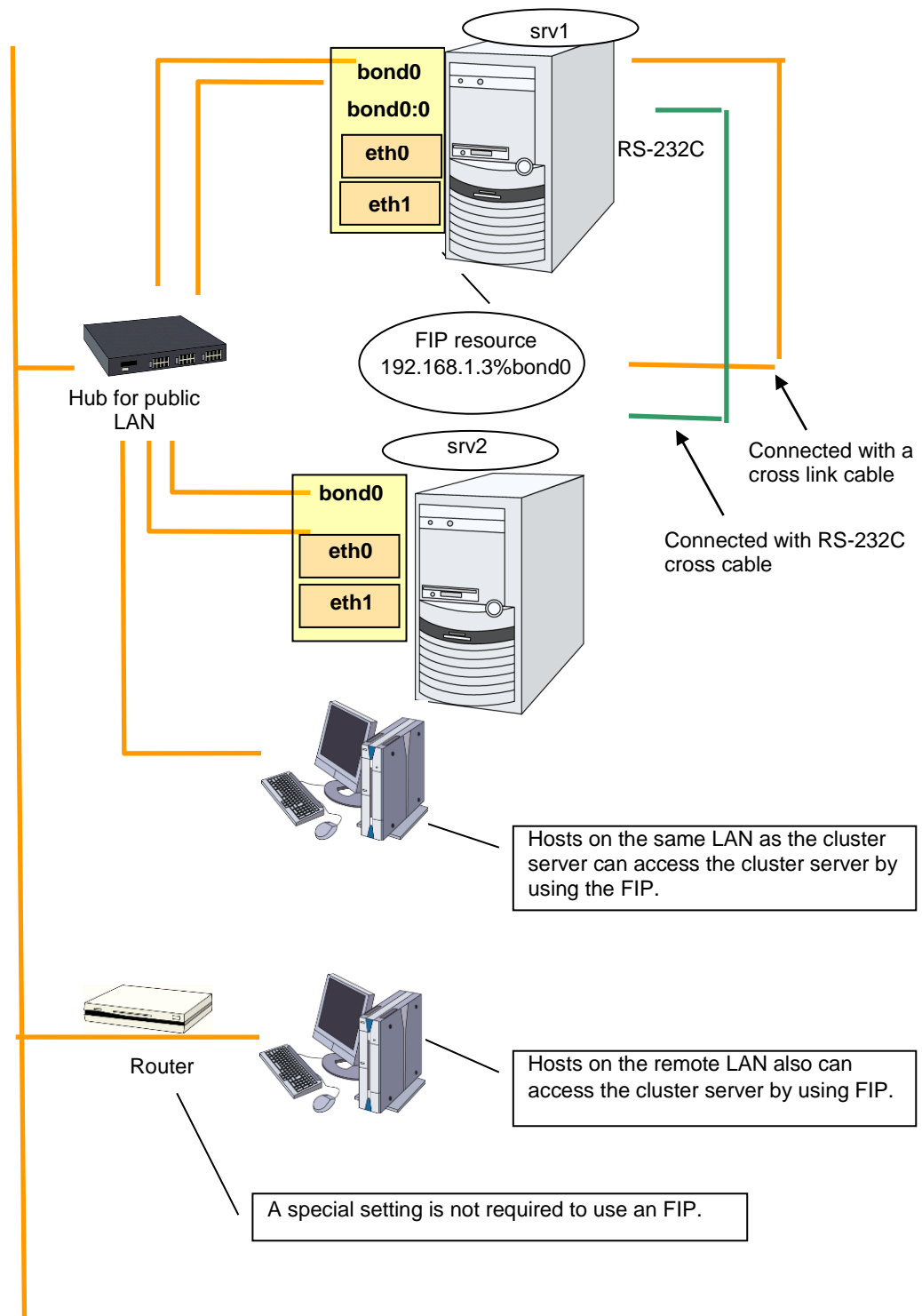

---

When FIP resource is enabled on srv1 by ifconfig: (bonding mode is set to "balance-tlb(5).")

---

```
$ ifconfig
```

```
bond0    Link encap:Ethernet  HWaddr 00:00:01:02:03:04
         inet addr:192.168.1.1 Bcast:192.168.1.255
         Mask:255.255.255.0
         UP BROADCAST RUNNING MASTER MULTICAST MTU:1500 Metric:1
         RX packets:6807 errors:0 dropped:0 overruns:0 frame:0
         TX packets:2970 errors:0 dropped:0 overruns:0 carrier:0
         collisions:0 txqueuelen:0
         RX bytes:670032 (654.3 Kb)  TX bytes:189616 (185.1 Kb)
```

(1)

```
bond0:0  Link encap:Ethernet  HWaddr 00:00:01:02:03:04
         inet addr:192.168.1.3 Bcast:192.168.1.255
         Mask:255.255.255.0
         UP BROADCAST RUNNING MASTER MULTICAST MTU:1500 Metric:1
         RX packets:236 errors:0 dropped:0 overruns:0 frame:0
         TX packets:2239 errors:0 dropped:0 overruns:0 carrier:0
         collisions:0 txqueuelen:0
         RX bytes:78522 (76.6 Kb)  TX bytes:205590 (200.7 Kb)
```

(2)

```
eth0     Link encap:Ethernet  HWaddr 00:00:01:02:03:04
         UP BROADCAST RUNNING SLAVE MULTICAST MTU:1500 Metric:1
         RX packets:3434 errors:0 dropped:0 overruns:0 frame:0
         TX packets:1494 errors:0 dropped:0 overruns:0 carrier:0
         collisions:0 txqueuelen:1000
         RX bytes:332303 (324.5 Kb)  TX bytes:94113 (91.9 Kb)
         Interrupt:18 Base address:0x2800 Memory:fc041000-fc041038
```

```
eth1     Link encap:Ethernet  HWaddr 00:00:05:06:07:08
         UP BROADCAST RUNNING SLAVE MULTICAST MTU:1500 Metric:1
         RX packets:215 errors:0 dropped:0 overruns:0 frame:0
         TX packets:1627 errors:0 dropped:0 overruns:0 carrier:0
         collisions:0 txqueuelen:1000
         RX bytes:77162 (75.3 Kb)  TX bytes:141394 (138.0 Kb)
         Interrupt:19 Base address:0x2840 Memory:fc042000-fc042038
```

```
eth2     Link encap:Ethernet  HWaddr 00:00:09:10:11:12
         inet addr:192.168.2.1 Bcast:192.168.2.255 Mask:
         255.255.255.0
         UP BROADCAST RUNNING MULTICAST MTU:1500 Metric:1
         RX packets:47 errors:0 dropped:0 overruns:0 frame:0
         TX packets:1525 errors:0 dropped:0 overruns:0 carrier:0
         collisions:0 txqueuelen:1000
         RX bytes:2820 (2.7 Kb)  TX bytes:110113 (107.5 Kb)
         Interrupt:24 Base address:0x3000 Memory:fc500000-fc500038
```

(3)

- 
1. Device where eth0 and eth1 are bonding.  
Used the public LAN, and 2nd interconnect LAN
  2. FIP enabled on bond0
  3. Used for the 1st interconnect LAN

## Mirror disk connect

### Notes

It is not recommended to use a mirror disk connect on bonding because communication may be interrupted temporarily when switching slave interfaces. Depending on the timing of mirroring, mirror recovery may be performed after switching bonding has completed.

### An example of bonding setup

The following is an example of setting up bonding on a mirror disk connect:

<b>Bonding</b>			
<b>Cluster Server</b>	<b>Device</b>	<b>Slave</b>	<b>Mode</b>
srv1	bond0	eth1	- balance-rr(0)
		eth2	- active-backup(1) - balance-tlb(5)
srv2	bond0	eth1	- balance-rr(0)
		eth2	- active-backup(1) - balance-tlb(5)

## Forced stop

### What is Forced stop?

This function forcibly stops the failing server by the another normal server when it is recognized that the server is failing.

This function stops a physical machine by using the IPMI function.

It stops the guest OS on a virtual machine by using the VMware vCenter Server function.

In addition to the functions above, you can execute a script in which the procedure for stopping the failing server is written. For details, refer to “Script for forced stop” in Chapter 8 “Information on other settings” in this guide.

### Conditions for performing forced stop

- ◆ Forced stop is not performed in the following cases:
  - When the failover group successfully stops before the server fails
  - When the server is shut down by the clpdown command, the OS shutdown command or WebManager and the failover group successfully stops
  - When the cluster is stopped by the clpcl command or WebManager and the failover group successfully stops
  - When the server fails and there is no failover group to perform failover from the failing server to another server (including when the failover group is not activated in the failing server)
- ◆ Forced stop is performed in the following case:
  - When the server is failing and there is a failover group to perform failover from the failing server to another server

### Commands to be used for forced stop

The ipmitool command, the hwreset command or the ireset command is used.

When the ipmitool command exists, use the ipmitool command. When the ipmitool command does not exist, use the hwreset command or the ireset command. If the commands are not installed, this function cannot be used.

Configure the following option values for the command execution on the **BMC** tab of the server properties.

Options for the ipmitool command	Options for the hwreset command	Information configured on the BMC tab of the server properties
-H [target IP address]	-N [target IP address]	IP address
-U [user name]	-U [user name]	User name
-P [password]	-P [password]	Password

See “IPMI command” on page 945 for the options used for the actions.

The `vmcontrol` command of the VMware vSphere Command Line Interface (vCLI) is used to forcibly stop the guest OS on a virtual machine. This function cannot be used if VMware vSphere Command Line Interface (vCLI) is not installed.

Specify the following option values for the command execution.

Option for the <code>vmcontrol</code> command	Information configured for Virtual Machine Forced Stop Setting on the Recovery tab of the cluster properties	Information configured for Input for Virtual Machine name on the Info tab of the server properties
<code>--server [vCenter IP address]</code>	IP address	-
<code>--username [vCenter user name]</code>	user name	-
<code>--password [vCenter password]</code>	password	-
<code>--xxxxxx [virtual machine name]</code>	-	Virtual machine name

The following option is used for action.

Command	Option	Description
<code>vmcontrol</code>	<code>--operation poweroff</code>	Powers off the guest OS on a virtual machine

## Notes on the forced stop

- ◆ Forcibly stopping the guest OS on a virtual machine  
Only power off operation can be performed. This function cannot be used if communication with VMWare vCenter Server cannot be performed.
- ◆ Versions of `ipmiutil`  
When you use the `hwreset` command or the `ireset` command, use `ipmiutil 1.7.9-1` or later.
- ◆ Notes on `ipmitool`, `hwreset` and `ireset`  
See “IPMI command” on page 945 in “Monitor resource”.
- ◆ Impacts of forced stop  
When you use the forced stop function, the following functions are influenced because power off, reset, power cycle or NMI is forcibly performed regardless of the OS or server status.
  - Dump collection  
Since it is not recognized that dump files are being collected, power off, reset or power cycle is performed even though dump collection is being performed, so dump collection does not complete.
  - Power on within the heartbeat timeout  
When the server is powered on again for the purpose of maintenance etc. within heartbeat timeout, power off, reset, power cycle or NMI may occur after heartbeat timeout has elapsed.
- ◆ BMC network settings  
Configure the settings so that the IP address of the LAN port for BMC management and the IP address which OS uses can communicate with each other. This function cannot be used in the environment where the network for the BMC management is blocked.  
Set the same IP address that is configured in the LAN port for the BMC management to the

**BMC** tab of the server properties.

See the server's manuals etc. for information on how to configure the IP address of the LAN port for the BMC management etc.

For the settings, see “Cluster properties Recovery tab” and “Server properties BMC tab” in Chapter 2, “Functions of the Builder” in this guide.

## Supported commands

Operations have been checked for the following distributions and commands.

Distribution	Versions of ipmiutil or OpenIPMI-tools	Server
Red Hat Enterprise Linux AS 4 (update6)	OpenIPMI-tools-1.4.14-1.4E.20	Express5800/120Rg-1
Red Hat Enterprise Linux 5 (update1)	ipmiutil-1.7.9-1.x86_64.rpm	Express5800/120Rg-1
MIRACLE LINUX V4.0 SP2	OpenIPMI-tools-1.4.20-1.1AX	Express5800/120Rf-1
Asianux Server 3	OpenIPMI-tools-2.0.6-5.3	Express5800/120Rg-2

## Script for forced stop

### What is the script for forced stop?

When it is recognized that the server is failing, any script created by the user can be executed on one of the rest of servers working normally. The failing server can be stopped forcibly by using the script.

### Conditions for executing the script for forced stop

- The script for forced stop is not executed when:
  - The failover group successfully stops before the server fails
  - The server is shut down by the clpdown command, the OS shutdown command or WebManager and the failover group successfully stops
  - The cluster is stopped by the clpcl command or WebManager and the failover group successfully stops
  - The server fails and there is no failover group to perform failover from the failing server to another server (including when the failover group is not activated in the failing server)
- The script for forced stop is executed when the server is failing and there is a failover group to perform failover from the failing server to another server.

### Features of the script for forced stop

#### Environment variables used in the script for forced stop

EXPRESSCLUSTER stores the data such as the information of a failing server to environment variables.

You can use the following environment variables for branch conditions in the script to describe the procedure tailored to the operations of your system.

Environment variable	Setting value	Description
CLP_SERVER_DOWN ...Down server name	Server name	Specifies the name of the failing server
CLP_SERVER_LOCAL ...Local server name	Server name	Specifies the name of the server where the script is executed.

#### Return value of the script for forced stop

Return 0 when the script terminates normally.

### Displaying and changing the details of the script for forced stop

For the settings of the script for forced stop, refer to “Cluster properties Recovery tab” in Chapter 2 “Function of the Builder” in this guide.

## Notes on the script for forced stop

- ◆ Describe the customer-defined process in the script to stop the server.
- ◆ When using the script for forced stop, refer to “Notes on the forced stop - Impacts on forced stop” of “The forced stop function” in Chapter 8 “Information on other settings” in this guide.
- ◆ When the forced stop function and the script for forced stop is used together, they are executed in the following order.
  1. The forced stop function
  2. The script for forced stop
- ◆ If the internal version is 3.3.3-1, you have to edit the script again after updating the version to 3.3.4-1 or later to use the script.



# Chassis Identify

## Chassis identify

This function allows for the other normal server to report the server failure by blinking the chassis ID lamp of a failing server by using the IPMI function when it recognizes that the server is failing

### Conditions for chassis ID lamp to blink

- ◆ The chassis ID lamp does not blink in the following cases:
  - When the status other than server status becomes abnormal
  - When cluster shutdown is performed
  - When all the servers in the cluster fail  
When the servers do not go down simultaneously, they blink for 250 seconds at the maximum, and eventually the chassis ID lamps of all servers go off.
  - When BMC of the failing server cannot communicate with the normal server
  - When there are normal servers in the cluster but EXPRESSCLUSTER is stopped
- ◆ The chassis ID lamp blinks in the following cases (the above conditions for not blinking are given priority over these conditions when they overlap):
  - When some of the servers in the cluster fail due to some abnormality
  - When some of the servers in the cluster are shut down by the shutdown command of the OS.
  - When some of the servers in the cluster are shut down by the clpdown command or WebManager
  - When EXPRESSCLUSTER is stopped by the clpcl command or WebManager in some of the servers in the cluster
  - When the init script (clusterpro) is made to be off in some of the servers in the cluster by the chkconfig and their OS is started
- ◆ Chassis ID lamp stops blinking and goes off in the following cases:
  - When there are normal servers in the cluster, and the server status of the failing server returns to normal

### Behavior of the chassis ID lamp blinking when the cluster stops

If the chassis ID lamp of a server in the cluster is in the blinking status when the cluster stops, the chassis ID lamp will behave as the following.

- It may keep blinking for 250 seconds at the maximum.

## Commands to be used for chassis identify

The ipmitool command, the alarms command, or the ialarms command is used.

Use the ipmitool command whenever it exists. When the ipmitool command does not exist, use the alarms or the ialarms command. If the commands are not installed, this function cannot be used.

Options for the ipmitool command	Options for the alarms command or the ialarms command	Information configured on the BMC tab of the server properties
-H [target IP address]	-N [target IP address]	IP address
-U [user name]	-U [user name]	User name
-P [password]	-P [password]	Password

## Notes on Chassis identify

- ◆ Versions of ipmiutil  
When you use the alarms command or the ialarms command, use ipmiutil 1.7.9-1 or later.
- ◆ Notes on ipmitool, alarms and ialarms  
See “IPMI command” on page 945 in “Monitor Resource”.
- ◆ BMC network settings  
Configure the settings so that the IP address of the LAN port for BMC management and the IP address which OS uses can communicate with each other. This function cannot be used in the environment where the network for the BMC management is blocked.  
Set the same IP address that is configured in the LAN port for the BMC management to the **BMC** tab of the server properties.  
See the server’s manuals etc. for information on how to configure the IP address of the LAN port for the BMC management etc.

For the settings, see “Cluster properties Recovery tab” and “Server properties BMC tab” in Chapter 2, “Functions of the Builder” in this guide.

## Supported commands

Operations have been checked for the following distributions and commands.

Distribution	Versions of ipmiutil or OpenIPMI-tools	Server
Red Hat Enterprise Linux AS 4 (update6)	OpenIPMI-tools-1.4.14-1.4E.20	Express5800/120Rg-1
Red Hat Enterprise Linux 5 (update1)	ipmiutil-1.7.9-1.x86_64.rpm	Express5800/120Rg-1
MIRACLE LINUX V4.0 SP2	OpenIPMI-tools-1.4.20-1.1AX	Express5800/120Rf-1
Asianux Server 3	ipmiutil-1.7.9-1.x86_64.rpm	Express5800/120Rg-2
Oracle Enterprise Linux 5	OpenIPMI-tools-2.0.6-5.el5.	Express5800/120Rg-2

# Alert Service

## What is Alert Service?

EXPRESSCLUSTER X Alert Service (hereafter Alert Service) is a function to report failures mentioned above found in EXPRESSCLUSTER-installed cluster systems to system administrators in remote locations.

Failures are reported in three ways, each serving a different purpose.

**1. E-mail report**

Alert messages in the WebManager are sent by e-mail to administrators.

**2. Network Warning light**

The network warning light is a visual display of the status of the server. When the server shuts down successfully, the network warning light goes off.

The e-mail report and the network warning light function work independently of each other.

**3. SNMP trap sending**

When a WebManager alert message is displayed, the contents of the alert are sent with an SNMP trap.

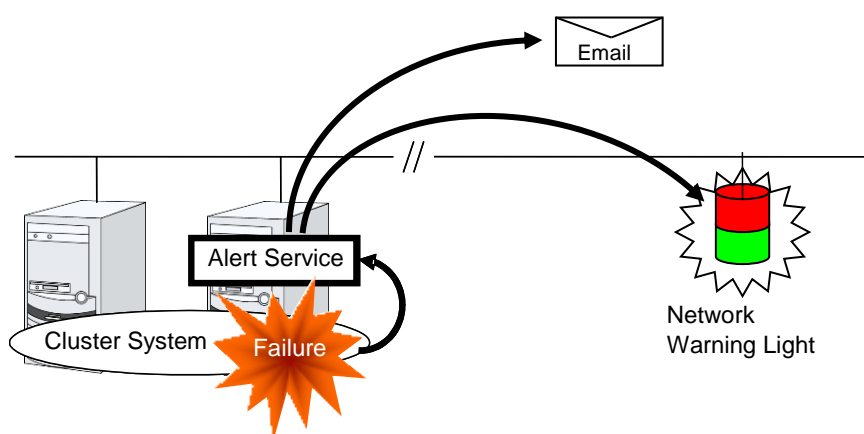

Alert Service allows you to:

- ◆ Receive information about failures while not physically located in the same place as the management PC. This is achieved via e-mail reporting function.
- ◆ Receive e-mail messages on your mobile phone.
- ◆ Visually be alerted of failures by viewing the network warning light.
- ◆ Recognize a failure audibly by reproducing the audio file for the network warning light.
- ◆ Notify the servers that are configured as the destination of the details of errors by SNMP trap sending.

Mail Report notifies the content of the alert in the following format by e-mail.

Subject:

EXPRESSCLUSTER

Body:

---

Message: Server [down server] has been stopped.  
Type: nm  
ID: 2  
Host: [mail sending source server name]  
Date: [send time stamp]

---

## Notes on Alert Service

- ◆ To use the mail report and network warning light functions, EXPRESSCLUSTER X Alert Service 3.1 for Linux is required.
- ◆ The task of Alert Service is to send the first report of failure but not to examine or find the cause of failure. When a failure occurs, instead of using the Alert Service, try other methods, such as viewing EXPRESSCLUSTER logs or syslog, to find out the cause of the error.
- ◆ If you use the Linux network warning light function, it may prove necessary to install the rsh package

## Mail report actions

- ◆ Alert Service sends the same messages as the WebManager. See “Messages reported by syslog, alert and mail” in Chapter 12, “Error messages” in this guide for information on which alert messages to be sent.
- ◆ You can change the alerts that are reported by e-mail. For more information, see “Cluster properties Alert Service tab” in Chapter 2, “Functions of the Builder” in this guide.

## Network Warning Light status

The network warning light performs the following operations.

1. When the server is started

When the server starts up successfully, warning light changes to green.

2. When the server shuts down

When the server shuts down successfully, warning light goes off.

3. When the server fails

When the server fails, its warning light flashes in red. If all servers in the cluster fail, the warning light of the server that failed last will not work because the network warning light is controlled by a normal server that monitors other servers.

Once the network warning light is lit or starts flashing, it will not go off until the cluster shuts down. Run the `clplamp` command introduced in the following section to put the light out. For more information on the `clplamp` command, see “Turning off warning light (`clplamp` command)” in Chapter 3, “EXPRESSCLUSTER command reference” in this guide.

For a network warning light (specified by NEC) that supports playback of an audio file, the setting also enables audio file reproduction to link to On/Off.

## Operations of SNMP trap sending

- ◆ The contents of WebManager alert messages are sent with an SNMP trap. For alert messages subject to SNMP trap sending, see “Messages reported by syslog, alert and mail, and SNMP trap” in Chapter 12, “Error messages” in this guide.
- ◆ The alerts subject to SNMP trap sending can be changed. For more information, see “Cluster properties Alert Service tab” in Chapter 2, “Functions of the Builder” in this guide.
- ◆ For details on the SNMP trap, see “SNMP trap sending”.

## SNMP linkage

### SNMP linkage

SNMP linkage enables SNMP trap sending from EXPRESSCLUSTER and information acquisition by SNMP from an SNMP manager according to the EXPRESSCLUSTER MIB definitions.

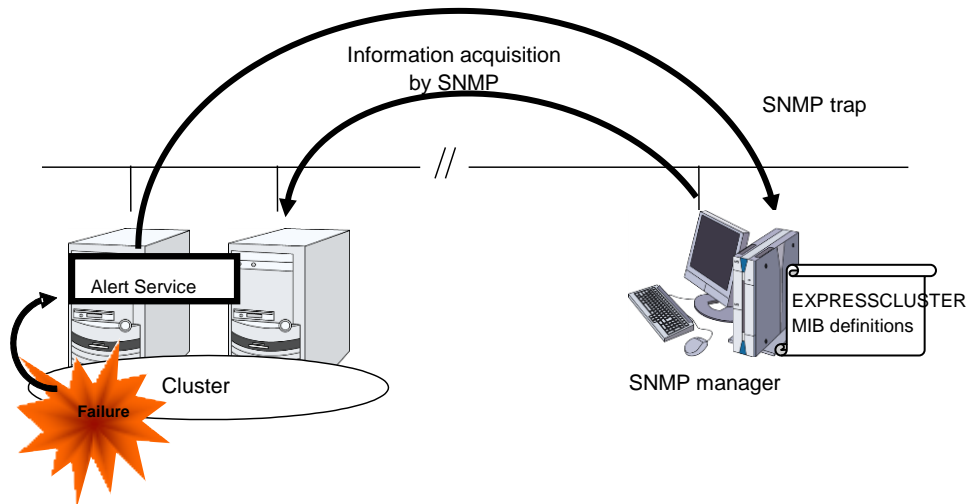

### EXPRESSCLUSTER MIB definitions

The information sent/acquired with SNMP linkage is configured by the MIB definition files.

To use the functions of SNMP trap sending and information acquisition by SNMP, described later, MIB definition files are required.

To receive SNMP traps from EXPRESSCLUSTER by using an SNMP manager, or to acquire cluster statuses from an SNMP manager, set the EXPRESSCLUSTER MIB definition files in the SNMP manager.

For how to set the MIB definition files in an SNMP manager, refer to the manual for the SNMP manager.

The EXPRESSCLUSTER MIB definition files are placed in the following directory on the EXPRESSCLUSTER X CD-ROM.

```
<EXPRESSCLUSTER_X_CD-ROM>\Common\<version number>\common\mib
```

The MIB definition files provide the functions described below.

No.	MIB definition file	Description
(1)	NEC-CLUSTER-SMI.mib	Configures the EXPRESSCLUSTER MIB tree root path.
(2)	NEC-CLUSTER-EVENT-MIB.mib	Configures the trap and MIB definitions for the EXPRESSCLUSTER SNMP trap sending function.
(3)	NEC-CLUSTER-MANAGEMENT-MIB.mib	Configures MIB definitions for the following EXPRESSCLUSTER information: <ul style="list-style-type: none"> <li>• Cluster information</li> <li>• Server information</li> <li>• Group information</li> </ul>

The available functions depend on the files set in the SNMP manager.

**To receive SNMP traps from EXPRESSCLUSTER:**

- (1) NEC-CLUSTER-SMI.mib
- (2) NEC-CLUSTER-EVENT-MIB.mib

**To acquire information by SNMP:**

- (1) NEC-CLUSTER-SMI.mib
- (3) NEC-CLUSTER-MANAGEMENT-MIB.mib

## SNMP trap sending

SNMP trap sending serves to send the contents of WebManager alert messages to the SNMP manager.

The traps to be sent are defined by NEC-CLUSTER-EVENT-MIB.

NEC-CLUSTER-EVENT-MIB defines the following MIB objects.

**clusterEventNotifications group**

This group defines the traps to be sent. The MIB objects defined for the group function as described below.

No.	SNMP TRAP OID	Description
(1)	clusterEventInformation	Trap for information level alerts. A clusterEvent group MIB object is attached.
(2)	clusterEventWarning	Trap for warning level alerts. A clusterEvent group MIB object is attached.
(3)	clusterEventError	Trap for error level alerts. A clusterEvent group MIB object is attached.

**clusterEvent group**

This group defines the information appended to the traps. The MIB objects defined for the group function as described below.

No.	SNMP OID	Description
(1)	clusterEventMessage	Indicates the alert message.
(2)	clusterEventID	Indicates the event ID.
(3)	clusterEventDateTime	Indicates the time at which the alert originated.
(4)	clusterEventServerName	Indicates the server from which the alert originated.
(5)	clusterEventModuleName	Indicates the module from which the alert originated.

## Information acquisition by SNMP

By using the SNMP protocol, some information about the EXPRESSCLUSTER configuration and status can be acquired. However, EXPRESSCLUSTER does not include SNMP agent functions. For an SNMP agent, the Net-SNMP snmpd daemon needs to be implemented separately.

**SNMP agent**

The SNMP agent serves to return a response about the configuration information or status information (GetResponse) to information acquisition requests (GetRequest, GetNextRequest) from an SNMP manager (network management software).

---

**Note:**

To use information acquisition by SNMP, you must take the steps described in “Setting up the SNMP linkage function” in the *Installation and Configuration Guide*.

---











## MIB objects acquirable with SNMP linkage

The MIB objects that can be acquired with the SNMP linkage function are defined by NEC-CLUSTER-MANAGEMENT-MIB.

NEC-CLUSTER-MANAGEMENT-MIB defines the following MIB objects.















### clusterGeneral group

This group is used to acquire cluster information. The MIB objects defined for the group function as described below.

No.	SNMP OID	Description										
(1)	clusterName	Indicates the name of the cluster.										
(2)	clusterComment	Indicates the comment of the cluster.										
(3)	clusterStatus	<p>Indicates the current status of the cluster.</p> <p>The correspondence between the MIB value and the WebManager status is as described below.</p> <table border="1"> <thead> <tr> <th>MIB value</th> <th>WebManager status</th> </tr> </thead> <tbody> <tr> <td>normal</td> <td> Normal</td> </tr> <tr> <td>caution</td> <td> Caution</td> </tr> <tr> <td>error</td> <td> Error</td> </tr> <tr> <td>unknown</td> <td>-</td> </tr> </tbody> </table>	MIB value	WebManager status	normal	 Normal	caution	 Caution	error	 Error	unknown	-
MIB value	WebManager status											
normal	 Normal											
caution	 Caution											
error	 Error											
unknown	-											





















**clusterServer group**

This group is used to acquire server information. Indexes on acquisition of clusterServerTable are sorted by server priority. The MIB objects defined for the group function as described below.

No.	SNMP OID	Description												
(1)	clusterServerLocalServerIndex	Indicates the index of the server receiving the present SNMP information acquisition request (clusterServerIndex).												
(2)	clusterServerTable	Indicates the information table for the server.												
(3)	clusterServerEntry	Indicates the server information list. The index for the list is clusterServerIndex.												
(4)	clusterServerIndex	Indicates the index for uniquely identifying the server.												
(5)	clusterServerName	Indicates the name of the server.												
(6)	clusterServerComment	Indicates a comment for the server.												
(7)	clusterServerStatus	<p>Indicates the current status of the server.</p> <p>The correspondence between the MIB value and the WebManager status is as described below.</p> <table border="1"> <thead> <tr> <th>MIB value</th> <th>WebManager status</th> </tr> </thead> <tbody> <tr> <td>online</td> <td> Online</td> </tr> <tr> <td>caution</td> <td> Suspension (Network Partition Unsolved)</td> </tr> <tr> <td>isolated</td> <td> Suspension (Isolated)</td> </tr> <tr> <td>offline</td> <td> Offline</td> </tr> <tr> <td>unknown</td> <td> Unknown</td> </tr> </tbody> </table> <p>*Values other than those indicated above may be acquired depending on the status of the server.</p>	MIB value	WebManager status	online	 Online	caution	 Suspension (Network Partition Unsolved)	isolated	 Suspension (Isolated)	offline	 Offline	unknown	 Unknown
MIB value	WebManager status													
online	 Online													
caution	 Suspension (Network Partition Unsolved)													
isolated	 Suspension (Isolated)													
offline	 Offline													
unknown	 Unknown													
(8)	clusterServerPriority	Indicates the priority of the server.												
(9)	clusterServerProductName	Indicates the name of the EXPRESSCLUSTER product installed on the server.												
(10)	clusterServerProductVersion	Indicates the version of the EXPRESSCLUSTER product installed on the server.												
(11)	clusterServerProductInstallPath	Indicates the installation path of EXPRESSCLUSTER on the server.												
(12)	clusterServerPlatformName	Indicates the name of the platform on the server.												

**clusterGroup group**

This group is used to acquire group information. The MIB objects defined for the group function as described below.

No.	SNMP OID	Description																
(1)	clusterGroupTable	Indicates the information table for the group.																
(2)	clusterGroupEntry	Indicates the group information list. The index for the list is clusterGroupIndex.																
(3)	clusterGroupIndex	Indicates the index for uniquely identifying the group.																
(4)	clusterGroupName	Indicates the name of the group.																
(5)	clusterGroupComment	Indicates a comment for the group.																
(6)	clusterGroupType	Indicates the type of the group. The correspondence between the MIB value and the group type is as described below. <table border="1" data-bbox="874 817 1420 981"> <thead> <tr> <th>MIB value</th> <th>Group type</th> </tr> </thead> <tbody> <tr> <td>failover</td> <td>Failover group</td> </tr> <tr> <td>cluster</td> <td>Management group</td> </tr> <tr> <td>virtualMachine</td> <td>Virtual machine group</td> </tr> </tbody> </table>	MIB value	Group type	failover	Failover group	cluster	Management group	virtualMachine	Virtual machine group								
MIB value	Group type																	
failover	Failover group																	
cluster	Management group																	
virtualMachine	Virtual machine group																	
(7)	clusterGroupStatus	Indicates the current status of the group. The correspondence between the MIB value and the WebManager status is as described below. <table border="1" data-bbox="874 1099 1420 1621"> <thead> <tr> <th>MIB value</th> <th>WebManager status</th> </tr> </thead> <tbody> <tr> <td>online</td> <td> Online</td> </tr> <tr> <td>onlineFailure</td> <td> Online Failure</td> </tr> <tr> <td>offlineFailure</td> <td> Offline Failure</td> </tr> <tr> <td>offline</td> <td> Offline</td> </tr> <tr> <td>unknown</td> <td> Unknown</td> </tr> <tr> <td>onlinePending</td> <td> Online Pending</td> </tr> <tr> <td>offlinePending</td> <td> Offline Pending</td> </tr> </tbody> </table>	MIB value	WebManager status	online	 Online	onlineFailure	 Online Failure	offlineFailure	 Offline Failure	offline	 Offline	unknown	 Unknown	onlinePending	 Online Pending	offlinePending	 Offline Pending
MIB value	WebManager status																	
online	 Online																	
onlineFailure	 Online Failure																	
offlineFailure	 Offline Failure																	
offline	 Offline																	
unknown	 Unknown																	
onlinePending	 Online Pending																	
offlinePending	 Offline Pending																	
(8)	clusterGroupCurrentServerIndex	Indicates the index of the server on which the group is currently active (clusterServerIndex). The return value of a deactivated group is -1.																

## Cluster service automatic startup prohibition after improper stop

### Cluster service automatic startup prohibition

This function prohibits the EXPRESSCLUSTER service from automatically starting up at the next OS activation after the cluster has been shut down, reboot, or stopped by WebManager or the EXPRESSCLUSTER service has been stopped by using a command other than the `clpstdn` command and the `clpcl -t -a` command.

When the automatic startup prohibition setting is enabled, the EXPRESSCLUSTER service will not automatically start at the next server activation after the cluster has been shut down, reboot, or stopped by WebManager or the EXPRESSCLUSTER service has been stopped by using a command other than the `clpstdn` command and the `clpcl -t -a` command.

Even in cases where cluster shutdown or cluster stop is executed, if an error occurs in the EXPRESSCLUSTER service stop sequence, or if the stop sequence is not executed due to the likes of an OS reset or a power interruption, the EXPRESSCLUSTER service will not automatically start at the next OS activation.

### Displaying and changing the automatic startup prohibition setting

- ◆ **Cluster service's not stop normal, prohibit automatic startup**  
Prohibits cluster service automatic startup at the next OS activation if the servers are stopped by a means other than cluster shutdown or cluster stop, or if the cluster shutdown or stop sequence does not finish successfully.
- ◆ **Not prohibit cluster service automatic startup after improper stop**  
Does not prohibit cluster service automatic startup.

### Conditions for automatic startup prohibition

The conditions for automatic startup prohibition are as described below.

- ◆ The cluster is stopped by a means other than cluster shutdown or cluster stop.
- ◆ The cluster service stop sequence is not executed due to a reason such as an OS reset, panic, or power interruption.
- ◆ Group deactivation fails in the cluster service stop sequence as a result of cluster shutdown or stop.
- ◆ The cluster is stopped on one of the servers comprising the cluster.

### Notes on automatic startup prohibition

- ◆ At OS activation, if the EXPRESSCLUSTER service does not start automatically, activate the EXPRESSCLUSTER service by using WebManager or the `clpcl` command.
- ◆ At OS activation, if the EXPRESSCLUSTER service does not start automatically, WebManager alert messages and syslog messages are output.

## **NX7700x series linkage**

### **NX7700x series linkage**

It can't be used.

## Express5800/A1080a or Express5800/A1040a series linkage

### Express5800/A1080a or Express5800/A1040a series linkage

Express5800/A1080a or Express5800/A1040a series linkage takes over operations by linking to EXPRESSCLUSTER if the BMC installed on a server detects an error.

This function uses BMC heartbeat resources and message receive monitor resources.

BMC heartbeat resources monitor whether the target servers are active by using the BMC network.

Setting a message receive monitor resource for Express5800/A1080a or Express5800/A1040a series linkage makes the BMC installed on the server report an error to execute a recovery operation.

### Notes on Express5800/A1080a or Express5800/A1040a series linkage

To use this function, the following conditions must be satisfied.

- The hardware and firmware of the BMC must support this function. For the available models, refer to “Servers supporting Express5800/A1080a or Express5800/A1040a series linkage” in Chapter 3, “Installation requirements for EXPRESSCLUSTER” in the *Getting Started Guide*.
- The ipmi service must be started in advance.
- To use this function in the same environment as that for ESMPRO Agent, use the ESMPRO Agent control panel (ESMamsadm) to change the agent event operation after report from **Shutdown** to **No Operation**.

Source name: ESMCOMMONSERVICE, ID: C00001FD, C0000203, C0000454

[Starting the control panel (ESMamsadm)]

- 1) Log in as a root user.
- 2) Move to the directory containing ESMamsadm.  

```
# cd /opt/nec/esmpro_sa/bin/
```
- 3) Start the control panel (ESMamsadm).

```
# ./ESMamsadm
```

[Specifying an operation after report for each monitor event]

- 1) Start the control panel (ESMamsadm) and select **Agent Event Setting**.
- 2) Select a source for **Source Name**. (Use the ↑ or ↓ key.)
- 3) Select an event ID for **Event ID**. (Use the ↑ or ↓ key.)
- 4) Click the **Setting...** button. The **Monitor Event Setting** window appears.
- 5) Change **Operation after Report** from **Shutdown** to **No Operation**.

For details, refer to the *ESMPRO Agent User's Guide (Linux)*.

## Creating configuration information for using Express5800/A1080a or Express5800/A1040a series linkage

The following describes, using an example, how to create the configuration information needed to use the Express5800/A1080a or Express5800/A1040a series linkage function.

### Sample cluster environment

The creation of configuration information is explained below using an example for configuring a cluster environment with the following network configuration. In the figure below, disk configuration and other data are omitted because they are not directly related to the Express5800/A1080a or Express5800/A1040a series linkage function.

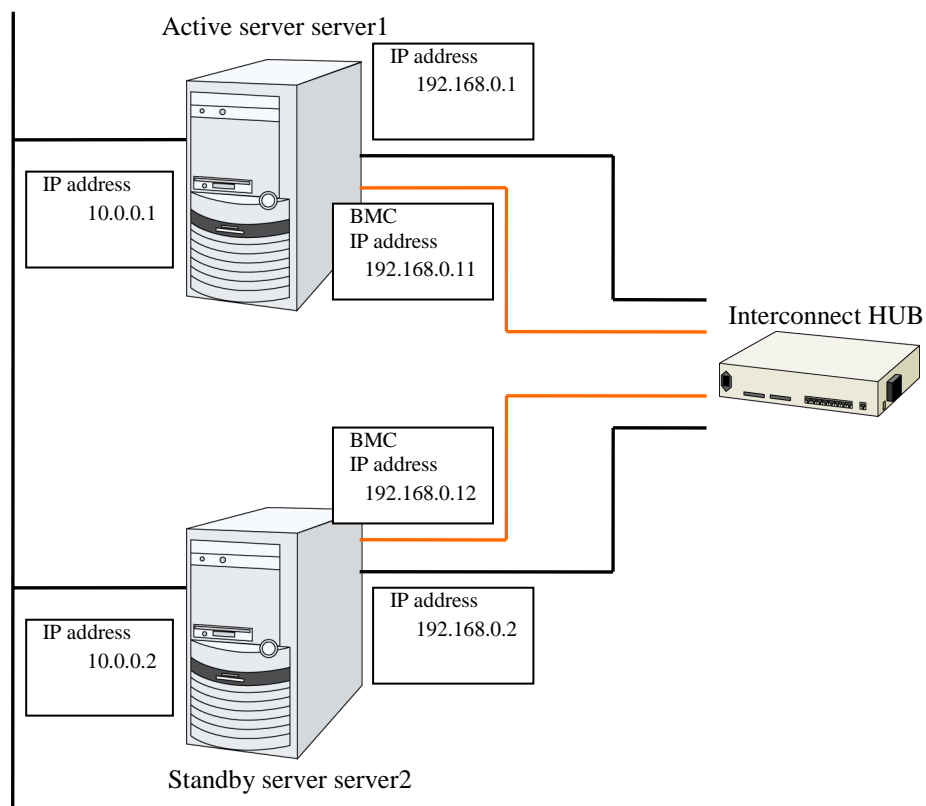

The following table lists sample values for the cluster configuration information that is used to configure the cluster system shown in the above figure. The following pages provide a step-by-step procedure for creating cluster configuration information for these conditions. When actually setting values, use the configuration information for the cluster to be configured.

	<b>Parameter to be set</b>	<b>Value</b>
Cluster configuration	Cluster name	cluster
	Number of servers	2
	Number of failover groups	1
	Number of monitor resources	2
Heartbeat resources	Number of LAN heartbeat resources	2
	Number of COM heartbeat resources	0
	Number of disk heartbeat resources	0
	Number of BMC heartbeat resources	1
First server information (master server)	Server name	server1
	Interconnect IP address (dedicated)	192.168.0.1
	Interconnect IP address (backup)	10.0.0.1
	BMC server Web console IP address	192.168.0.11
Second server information	Server name	server2
	Interconnect IP address (dedicated)	192.168.0.2
	Interconnect IP address (backup)	10.0.0.2
	BMC server Web console IP address	192.168.0.12
First group	Type	Failover
	Group name	failover1
	Starting server	All servers
	Number of group resources	-
Group resource (omitted)	-	-
	-	-
	-	-
First monitor resource (default)	Type	user-mode monitor
	Monitor resource name	userw
Second monitor resource	Type	message receive monitor
	Category	BMCNOTICE
	Keyword (common)	192.168.0.1
	Keyword (Individual server setting: server1)	192.168.0.1



Parameter to be set	Value
Keyword (Individual server setting: server2)	192.168.0.2
Recovery operation	Executes the failover for the recovery target.
Recovery target	failover1

---

**Procedure for creating cluster configuration information**

The creation of cluster configuration information involves the following three basic steps: creating a cluster, creating groups, and creating monitor resources. The following shows the flow of the procedure for setting items specific to Express5800/A1080a or Express5800/A1040a series linkage. For other items, refer to Chapter 5, “Creating cluster configuration information” in the *Installation and Configuration Guide*.

**Note:**

An operation on cluster configuration information can be performed any number of times. Most settings can be modified later by using the rename function or the properties view function.

---

## **1 Creating a cluster**

Create a cluster and add servers.

### **1-1 Adding a cluster**

Add a cluster you want to construct and enter its name. This item contains no settings that are specific to Express5800/A1080a or Express5800/A1040a series linkage.

### **1-2 Adding servers**

Add servers and set their server names, IP addresses, and other items. This item contains no settings that are specific to Express5800/A1080a or Express5800/A1040a series linkage.

### **1-3 Setting the network configuration**

Set the network configuration between servers that constitute the cluster. Set BMC heartbeat resources as an item specific to Express5800/A1080a or Express5800/A1040a series linkage.

### **1-4 Setting network partition resolution resources**

Set the network partition resolution resources. This item contains no settings that are specific to Express5800/A1080a or Express5800/A1040a series linkage.

## **2 Creating a failover group**

Create a failover group that operates as a unit when failover occurs. This item contains no settings that are specific to Express5800/A1080a or Express5800/A1040a series linkage.

### **2-1 Adding a failover group**

Add a group that operates as a unit when failover occurs. This item contains no settings that are specific to Express5800/A1080a or Express5800/A1040a series linkage.

### **2-2 Adding a group resource**

Add a resource that constitutes a group. This item contains no settings that are specific to Express5800/A1080a or Express5800/A1040a series linkage.

## **3 Creating a monitor resource**

Create a monitor resource that monitors the specified target in the cluster.

### **3-1 Adding a monitor resource (message receive monitor)**

Add a monitor resource to use.

## 1 Procedure for creating a cluster

First, create a cluster. To the created cluster, add a server that is part of the cluster and determine the priorities of the server and heartbeat. Only steps 1 to 3 contain the settings that are specific to Express5800/A1080a or Express5800/A1040a series linkage.

### 1-1 Adding a cluster

This item contains no settings that are specific to Express5800/A1080a or Express5800/A1040a series linkage.

### 1-2 Adding servers

This item contains no settings that are specific to Express5800/A1080a or Express5800/A1040a series linkage.

### 1-3 Setting the network configuration

Set the network configuration between the servers that constitute the cluster.

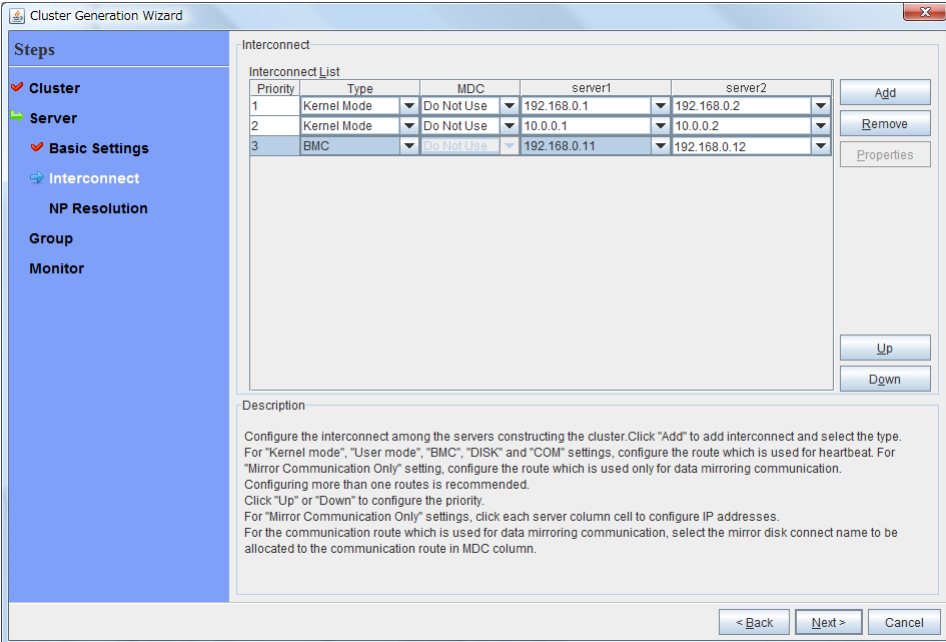

Priority	Type	MDC	server1	server2
1	Kernel Mode	Do Not Use	192.168.0.1	192.168.0.2
2	Kernel Mode	Do Not Use	10.0.0.1	10.0.0.2
3	BMC	Do Not Use	192.168.0.11	192.168.0.12

Description

Configure the interconnect among the servers constructing the cluster. Click "Add" to add interconnect and select the type. For "Kernel mode", "User mode", "BMC", "DISK" and "COM" settings, configure the route which is used for heartbeat. For "Mirror Communication Only" setting, configure the route which is used only for data mirroring communication. Configuring more than one routes is recommended. Click "Up" or "Down" to configure the priority. For "Mirror Communication Only" settings, click each server column cell to configure IP addresses. For the communication route which is used for data mirroring communication, select the mirror disk connect name to be allocated to the communication route in MDC column.

1. For the communication route used for BMC heartbeat transmission (interconnect), click a cell in the **Type** column, and then select **BMC**. Click a cell in the column for each server, and then enter the BMC server Web console IP address.

### 1-4 Setting network partition resolution resources

This item contains no settings that are specific to Express5800/A1080a or Express5800/A1040a series linkage.

## 2 Creating a failover group

This step contains no settings that are specific to Express5800/A1080a or Express5800/A1040a series linkage.

## 3 Creating a monitor resource

Create a monitor resource that monitors the specified target in the cluster. For the Express5800/A1080a or Express5800/A1040a series linkage function, set a message receive monitor. For details on the monitor, see “Express5800/A1080a or Express5800/A1040a series linkage with message receive monitor resources” (on page 1257).

### 3-1 Adding a monitor resource (message receive monitor)

Add a monitor resource that monitors the reception of an error report from the server.

1. Click **Next** in **Group**.
2. The **Monitor Resource** window appears. Click **Add**.
3. The **Monitor Resource Definition** dialog box appears. Select the monitor resource type (message receive monitor) from the **Type** box, and then enter the monitor resource name (mrw1) in the **Name** box. Click **Next**.
4. Enter the monitoring settings. Click **Next** without changing the default values.
5. Enter BMCNOTICE in the **Category** box and the IP address of the OS side of each server that can communicate with the BMC as the IP address of the destination of the error report in the **Keyword** box. Use the **Monitor(special)** tab because the IP addresses differ depending on the server. In this example, enter 192.168.0.1 for **Common** and **server1** and 192.168.0.2 for **server2**.
6. Set **Executing failover the recovery target** for **Recovery Action**. For Express5800/A1080a or Express5800/A1040a series linkage, select this setting for **Recovery Action**.
7. Set a recovery target. Click **Browse**. In the displayed tree view, select **failover1** and then click **OK**. **failover1** is set for **Recovery Target**.
8. Click **Complete**.

This completes the creation of cluster configuration information that is specific to Express5800/A1080a or Express5800/A1040a series linkage.

## Express5800/A1080a or Express5800/A1040a series linkage with message receive monitor resources

This function enables EXPRESSCLUSTER to immediately execute a recovery operation if the BMC installed on the Express5800/A1080a or Express5800/A1040a series detects an error.

When this function is not used, and the BMC detects an error, server reset and other operations are executed immediately. For this reason, required operations such as application termination are not executed.

When this function is used, even if the BMC detects an error, server reset and other operations are performed after EXPRESSCLUSTER executes recovery.

The following figure is an overview of the operation that is performed when Express5800/A1080a or Express5800/A1040a series linkage with message receive monitor resources is used.

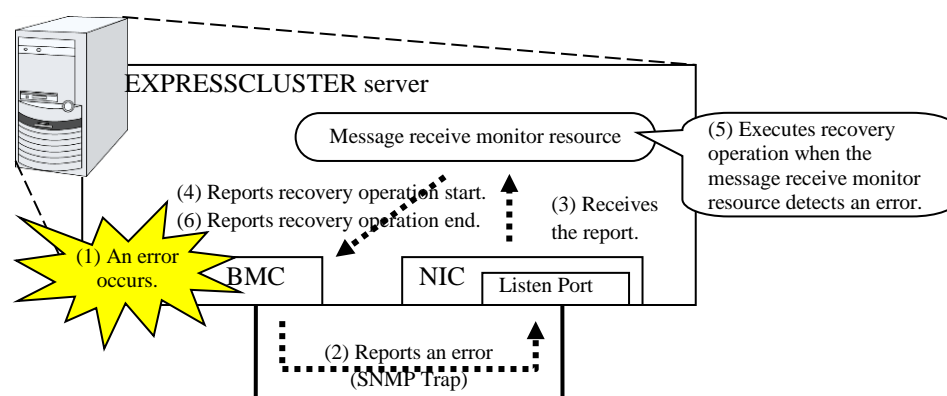

## Notes on Express5800/A1080a or Express5800/A1040a series linkage with message receive monitor resources

In addition to the conditions listed in “Notes on Express5800/A1080a or Express5800/A1040a series linkage” (on page 1250), the following condition must be satisfied.

- Since SNMP Traps are used for reporting an error from the BMC to a message receive monitor resource, communication using TCP/IP must be enabled between the BMC and OS network interfaces.

Also note the following points when setting BMC linkage:

- Set BMCNOTICE for **Category**.
- Unique values must be specified for **Keyword** on different servers. Specify the IP address and port number on the OS side connected to the BMC on each server as the destination of error reports.

## Displaying and changing the details of message receive monitor resources

1. Click a monitor resource icon in the tree view on the left side of the Builder window.
2. A list of monitor resources is displayed in the table view on the right side of the window. Right-click the name of the target message receive monitor resource, and then click the **Monitor(special)** tab in **Property**.
3. On the **Monitor(special)** tab, display or change the detailed settings as explained below.

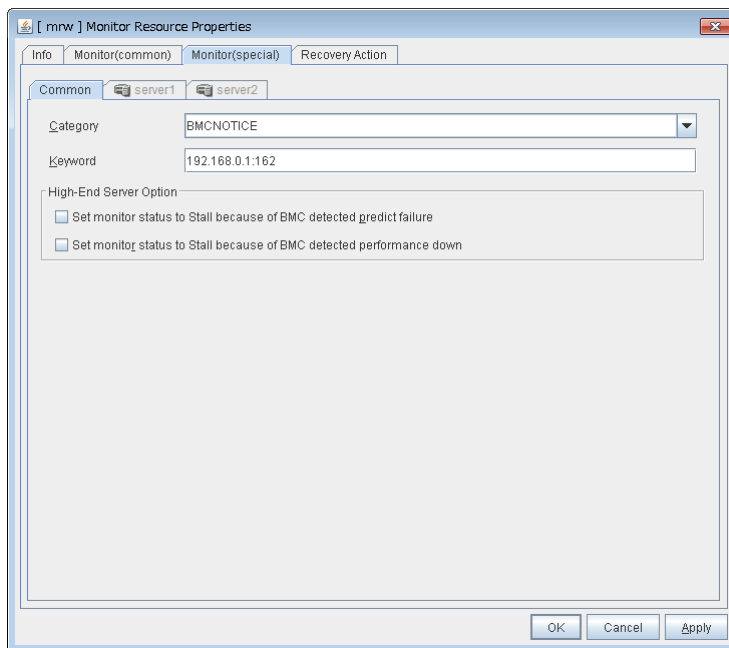

### Category (within 32 bytes)

Specify a category.  
Specify BMCNOTICE.

### Keyword (within 255 bytes)

Specify an IP address that can communicate with the BMC on each server. In this case, specify the IP address and port number for receiving error reports.

Use individual server settings to specify the values for each server.

The port number can be omitted (default: 162). To set the port number, use the same value for all the message receive monitor resources for the same server.

The format is as follows:

```
<IP address>[:<Port number>]
```

## **AWS elastic ip resources, AWS virtual ip resources, AWS elastic ip monitor resources, AWS virtual ip monitor resources and AWS AZ monitor resources**

The contents of this section have moved to "EXPRESSCLUSTER X 3.3 HA Cluster Configuration Guide for Amazon Web Services (Linux)". Please refer to the building tour guide who has that below.

<http://www.nec.com/en/global/prod/expresscluster/en/support/Setup.html>

## Azure probe port resources, Azure probe port monitor resources, and Azure load balance monitor resources

### Setting of the Microsoft Azure environment

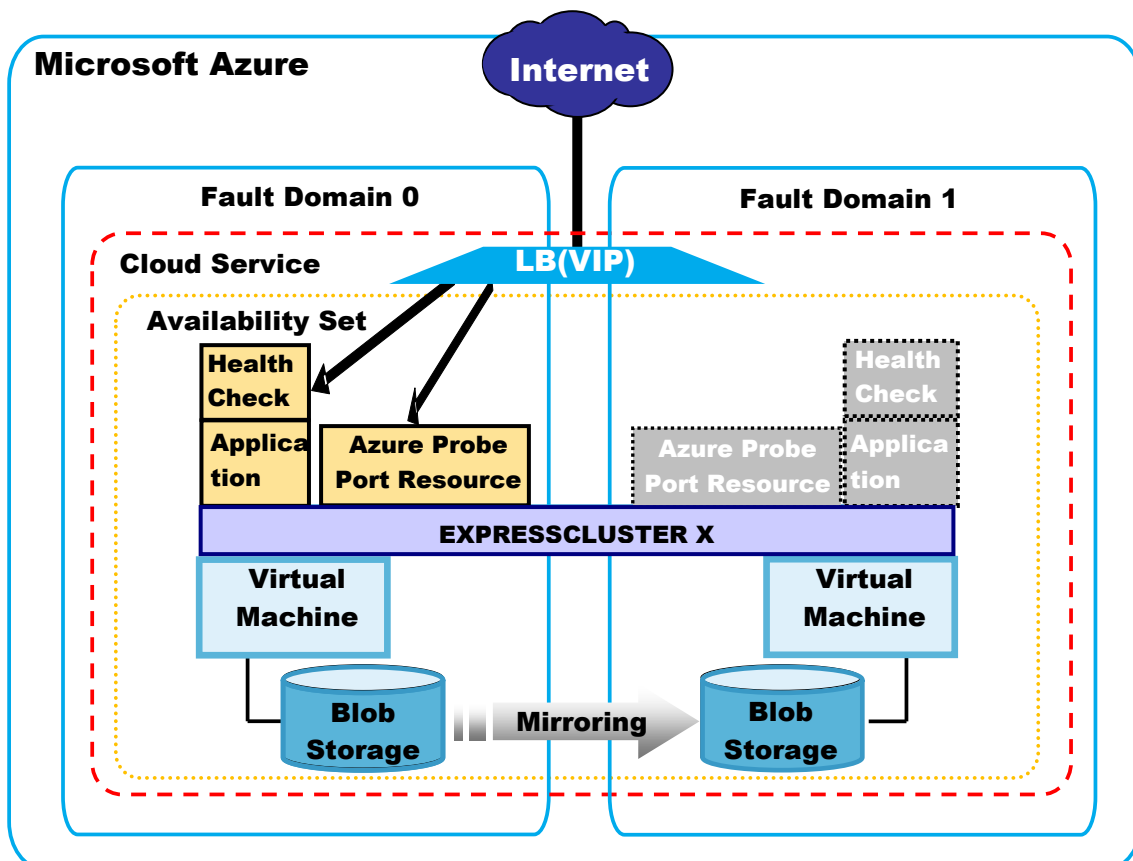

For the version information for the OSs on Azure on which the operation of the Azure probe port resource is verified, refer to “Operation environment for Azure probe port resource” in the *Getting Started Guide*.

You must set the port number to use with the alive monitoring (Health Check in the figure above) to be implemented by the Microsoft Azure load balancer. The alive monitoring process of the load balancer periodically accesses the port subject to alive monitoring. There are two ways to set the port number to use with alive monitoring.

- Method 1: Implementing alive monitoring by using a port different from the port that provides the application. Set the port number with **Probe Port** on the **Details** tab in **Azure probe port Resource Properties** in the Builder.
- Method 2: Implementing alive monitoring by using the same port as that provides the application. In this case, no Azure probe port resources, Azure probe port monitor resources, or Azure load balance monitor resources are necessary.

In the Microsoft Azure environment, you must create the following, and make settings in each virtual machine.



- Set a cloud service DNS name
- Create a virtual network
- Set a virtual network subnet
- Create a storage account
  - Create a storage account for adding a Blob to the virtual machines.
- Create virtual machines
  - Add the virtual machines that constitute a cluster.
- Set an availability set name
- Add a Blob
  - Add the Blob used with the mirror disk (cluster partition and data partition). For an explanation of the partitions for mirror disks, see "Partition settings for mirror disk resource" in Chapter 1 "Determining a system configuration" in the *Installation and Configuration Guide*.

Log into each created virtual machine, and make the following settings. For details, see the appropriate Microsoft Azure document.

- Set a static internal IP address(DIP) for the virtual machine
  - After installing the virtual machines, fix the IP addresses assigned inside subnets of the respective networks. The reason for this is to prevent the IP addresses to be assigned inside subnets from being changed due to the order in which to start the virtual machines.
- Set the end point for the application provided by EXPRESSCLUSTER
  - Set an end point to make the server that provides the application accessible from an external network, using a VIP or DNS name

## To the judgment of network partition resolution

It offers `clpazure_port_checker` commands that can be performed to determine the network partition resolution. For TCP port of the specified server, checks whether LISTEN exists.

`clpazure_port_checker`: the `clpazure_port_checker` command judges the network partition resolution.

### Command line

```
clpazure_port_checker -h host -p port
```

#### Description

This command is for the TCP port of the specified server in the argument, checks whether LISTEN exists.

If 5 seconds (fixed) there is no response elapsed and then determined to be abnormal(Timeout).

In the case of abnormality, it prints an error message to the stderr.

By executing this command from the *Understanding custom monitor resources*, it is possible to make a determination of the network partition resolution.

For an example of how to configure network partition resolution using this command, please refer to *For an example of how to configure network partition resolution*.

For network partition resolution, please refer to the *Network partition resolution resources details*.

<b>Option</b>	<code>-h <i>hostname</i></code>	Determining server is specified by hostname (FQDN name or IP address). Can not be omitted.
	<code>-p <i>port</i></code>	Determining port number is specified by the port (port number or service name). Can not be omitted.
<b>Return Value</b>	0	Success
	1	Failure(Communication Error)
	2	Failure(Timeout)
	3	Failure(Invalid argument, Internal Error)
<b>Configuration Example</b>	A setting example of the custom monitor resource when carrying out from a custom monitor resource, is mentioned.	

**Script created with this product**

Select the **Script created with this product**, set the following command in the script.

```
EXPRESS CLUSTER Install  
Path/bin/clpazure_port_checker -h host1 -p 26001
```

**Monitor Type**

Please select the Synchronous.

**Normal Return Value**

Please set the 0.

**For an example of how to configure network partition resolution**

Network partition resolution(or less, NP) as example of the configuration, there are two types of the following.

1. If you want to use the Microsoft Azure load balancer (if you want to publish the work in Microsoft Azure virtual network externalities)
2. If you want to use the Microsoft Azure internal load balancing(ILB) (if you want to publish the work to the internal virtual network of Microsoft Azure)

The described an example of the setting of the case of a two-node configuration.

1. If you want to use the Microsoft Azure load balancer (if you want to publish the work in Microsoft Azure virtual network externalities)

**Monitor resources**

- Custom monitor resource

This resource monitors whether communication with Microsoft Azure Service Management API is possible, and checks the health of the communication with the external network. Use the `clpazure_port_checker` command, you can create a monitor resource for communication confirmation to the Microsoft Azure of Service Management API.

For details, see *Understanding custom monitor resources*.

- (1) For **Monitor Resource Definition**, select **custom monitor**.
- (2) Set **Monitor Timing** to **Always**.
- (3) Select **Script created with this product**, and then create a script to monitor communication with the Microsoft Azure Service Management API. (Sample script to create is as follows.)

-----

```
#!/bin/sh
```

```
EXPRESS_CLUSTER InstallPath/bin/clpazure_port_checker -h  
management.core.windows.net -p 443
```

-----

- (4) For **Recovery Action** set **Final action only**, for **Recovery Target**, set **LocalServer**, and for **Final Action** set **No operation**.

#### - IP monitor resource

This resource monitors communications between clusters made up of virtual machines, and checks the health of the communication with the internal network. To check inter-cluster communication, create one IP monitor resource for each server.

For details, see *Understanding floating IP monitor resources*.

- (1) For **Monitor Resource Definition**, select **ip monitor**.
- (2) Set **Monitor Timing** to **Always**.
- (3) For **Choose servers that execute monitoring**, select and then add an available server.
- (4) From the IP address list, select **Add**, and set the IP address of a server other than that selected in step (3).
- (5) For **Recovery Action**, set **Final action only**, for **Recovery Target**, set **LocalServer**, and for **Final Action** set **No operation**.
- (6) On the other server, create a similar resource.

#### - multi-target monitor resource

This resource checks the states of both of the custom monitor resource that monitors communication with Microsoft Azure Service Management API and the IP monitor resource between clusters made up of virtual machines. If the states of both monitor resources become abnormal, it executes a script that describes processing for NP resolution.

To enable NP resolution, create a multi-target monitor resource to monitor the states of the custom monitor resource for checking communication and the IP monitor resource, created as described above.

If the multi-target monitor resource detects an error, and the local server can be checked as being active and offering services normally, the resource does nothing; otherwise, it shuts down the server.

For details, see *Understanding multi target monitor resources*.

- (1) From **Monitor Resource Definition**, select **multi-target monitor**.
- (2) Set **Monitor Timing** to **Always**.
- (3) From the list of available monitor resources, select **Add**, and then add a total of three resources, namely, the custom monitor resource for communication checking and the IP monitor resources that have been set on two servers.
- (4) For **Recovery Action**, set **Final action only**, select **Execute Script before Final Action:**, for **Recovery Target**, set **LocalServer**, and for **Final Action** set **No operation**.
- (5) Click **Script Settings**, and then create a script to execute if the multi-target monitor resource detects an error. (Sample script to create is as follows)

-----

```
#!/bin/sh
```

```
EXPRESS CLUSTER InstallPath/bin/clpazure_port_checker -h  
127.0.0.1 -p Private port
```

```
if [ $? -ne 0 ]
```

```
then
```

```
    clpdown
```

```
    exit 0
```

```
fi
```

```
EXPRESS CLUSTER InstallPath/bin/clpazure_port_checker -h  
DNS name of cloud service of Microsoft Azure -p Public port
```

```
if [ $? -ne 0 ]
```

```
then
```

```
    clpdown
```

```
    exit 0
```

```
fi
```

-----

- (6) For **Timeout of Script Settings**, set the value greater than the timeout of `clpazure_port_checker`(5 seconds (fixed)). The recommend value of this sample script is greater than 10 seconds.

### Other settings

#### - Cluster property

For Microsoft Azure and EXPRESSCLUSTER linkage, make the settings in the cluster properties as described below.

- (1) Migrate to **Config Mode** of the WebManager, right-click on the cluster name, and then select **Properties**.

- (2) Select the Timeout tab. For the heartbeat timeout value, set the result of "A + B + 30" (that is, "error detection time for the multi-target monitor resource + 30 seconds").

A: **Monitor interval** x (**Retry Count** + 1) of a monitor resource monitored by the multi-target monitor resource for NP resolution

\* Select the larger of the results of the above calculation for the two monitors.

B: **Monitor interval** x (**Retry Count** + 1) of the multi-target monitor resource

**Note:** If the heartbeat timeout value is shorter than the time for which the monitor for NP resolution detects an error, a heartbeat timeout will be detected before NP resolution processing is performed. In this case, a service may be started on the standby server, causing double start of the service within the cluster.

2. If you want to use the Microsoft Azure internal load balancing(ILB) (if you want to publish the work to the internal virtual network of Microsoft Azure)

PING network partition resolution resources is used. `clpazure_port_checker` It isn't necessary to use the command.

For details, see *Understanding network partition resolution by PING method*



# Chapter 9      Linkage with Server Management Infrastructure

This chapter provides an overview of the server management infrastructure included in Enterprise Linux with Dependable Support.

This chapter covers:

- Overview of the server management infrastructure ..... 1268
- Overview of linkage between the server management infrastructure and EXPRESSCLUSTER ..... 1269
- Setup of the function to link with the server management infrastructure..... 1270
- Message receive monitor resources ..... 1271

## Overview of the server management infrastructure

This server management infrastructure is included in Enterprise Linux with Dependable Support. This software provides the following functions:

- ◆ Recording information about failures detected by the expanded device driver
- ◆ Linking with EXPRESSCLUSTER X to perform a failover when the expanded device driver detects a fatal system failure

For details, see the manual for Enterprise Linux with Dependable Support.



# Overview of linkage between the server management infrastructure and EXPRESSCLUSTER

EXPRESSCLUSTER's function for linking with the server management infrastructure is not used for EXPRESSCLUSTER to perform monitoring itself. This linkage function is used for EXPRESSCLUSTER to receive messages spontaneously sent by the driver module and passively perform a failover or other processing.

The following shows an overview:

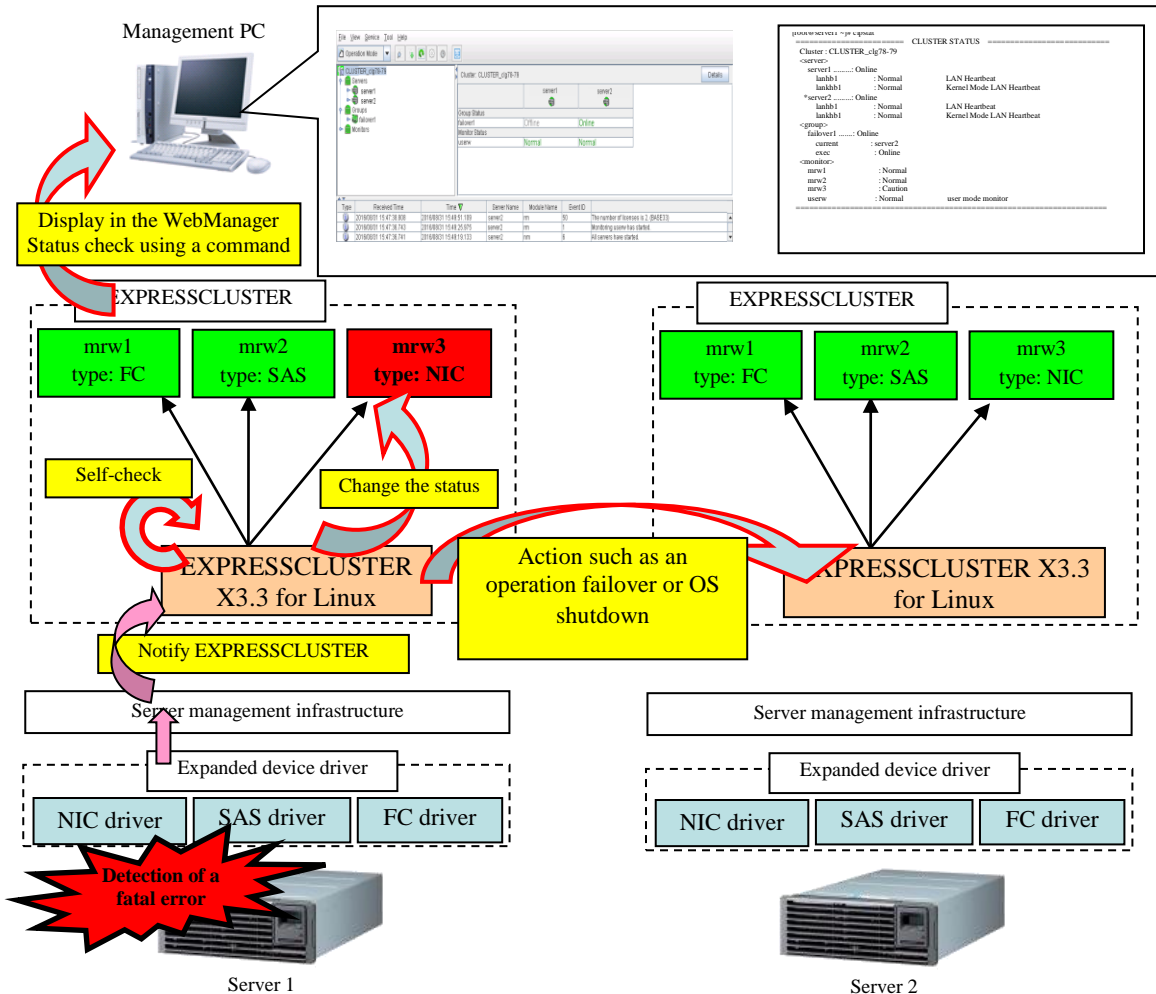

If a fatal system error occurs, the expanded device driver included in Enterprise Linux with Dependable Support (hereafter referred to as the expanded driver) sends a message to EXPRESSCLUSTER through the server management infrastructure. After receiving such a message, EXPRESSCLUSTER performs the following operations.

- ◆ EXPRESSCLUSTER makes the status of the corresponding message receive monitor (mrw) abnormal. The administrator can visually determine that an error was detected by checking the status using the WebManager or an EXPRESSCLUSTER command.
- ◆ When a failure occurs, EXPRESSCLUSTER performs an operation failover or shuts down the OS according to the specified action.

## Setup of the function to link with the server management infrastructure

For details about resources other than the message receive monitor resource, see the EXPRESSCLUSTER manuals below.

- ◆ Installing EXPRESSCLUSTER
  - Chapter 3 "Installing EXPRESSCLUSTER" in the *Installation and Configuration Guide*
  - Chapter 4 "Registering the license" in the *Installation and Configuration Guide*
  
- ◆ Creating EXPRESSCLUSTER configuration information
  - Chapter 5 "Creating the cluster configuration data" in the *Installation and Configuration Guide*
  - Chapter 6 "Verifying a cluster system" in the *Installation and Configuration Guide*

To use the function for linking with the server management infrastructure, the message receive monitor resources must be registered with the cluster. To create configuration information, register the necessary message receive monitor resources as described in the manual. For the message receive monitor resources, see "Message receive monitor resources" on page 1271.

- ◆ Uploading EXPRESSCLUSTER configuration information
  - Chapter 7 "Modifying the cluster configuration data" in the *Installation and Configuration Guide*

## Message receive monitor resources

The message receive monitor resources monitor error messages reported from outside. This section only covers the part associated with linkage with the server management infrastructure. For other cases, see Chapter 5, “Monitor resource details” on page 819.

### Notes on message receive monitor resources

A message receive monitor resource cannot execute any scrip before the final action if it is linked with the server management infrastructure.

Do not use the `clprexec` command, because EXPRESSCLUSTER manages the status of a message receive monitor resource if it is linked with the server management infrastructure.

When the keyword by a message receive monitor resource is specified, if an error is detected in the device specified as the monitor target, an error occurs and the error correction action is performed .

If no device is specified as the keyword by a message receive monitor resource and an error is detected in any device that matches the Category, an error occurs and the error correction action is performed.

## Category by a message receive monitor resource

A message receive monitor resource receives the following message types when it is linked with the server management infrastructure.

- 1. NIC**  
Monitors the error messages of network interface cards.
- 2. FC**  
Monitors the error messages of Fibre Channel.
- 3. HA/SS**  
Monitors the error messages of the EXPRESSCLUSTER X HA/StorageSaver.
- 4. HA/AM**  
Monitors the error messages of the EXPRESSCLUSTER X HA/ApplicationMonitor.
- 5. HA/RS**  
Monitors the error messages of the EXPRESSCLUSTER X HA/ResourceSaver.
- 6. SPS**  
Monitors the error messages of the SPS.

## Displaying and changing the details of the message receive monitor resources

1. Click a monitor resource icon in the tree view on the left side of the Builder window.
2. The list of monitor resources is shown in the table view on the right side of the screen. Right-click the target message receive monitor resource name, and then click the **Monitor(special)** tab in **Property**.
3. On the **Monitor(special)** tab, you can display or change the detailed settings by following the description below.

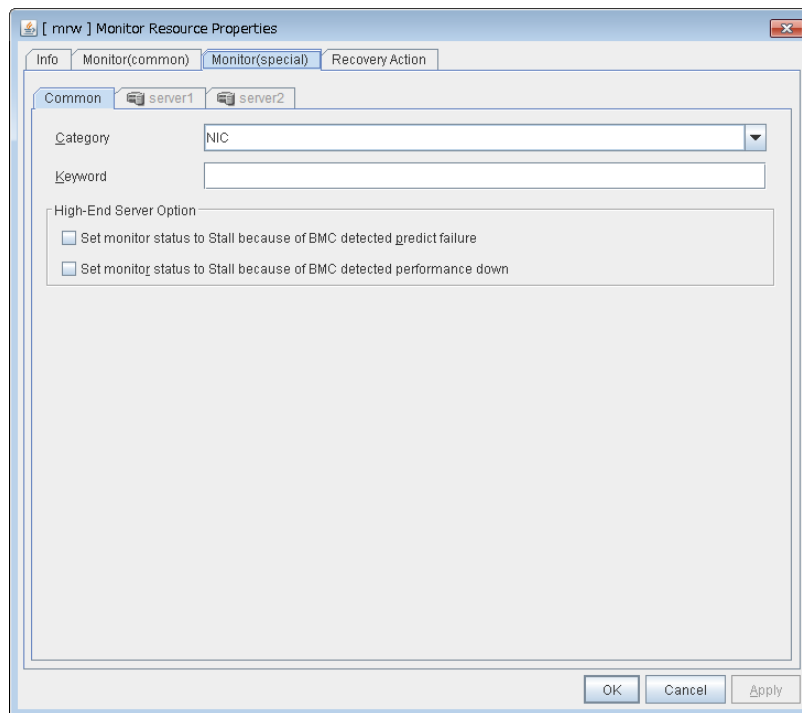

**Category** (within 32 bytes)

Specify a category.

Be sure to select a default character string from the list box.

**Keyword** (within 255 bytes)

Specify a monitor target.

## Displaying and changing the error detection settings of the message receive monitor resources

1. Click a monitor resource icon in the tree view on the left side of the Builder window.
2. The list of monitor resources is shown in the table view on the right side of the screen. Right-click the target monitor resource name, and then click the **Recovery Action** tab in **Property**.
3. On the **Recovery Action** tab, you can display or change the monitoring settings by following the description below.

Specify the recovery target and the action upon detecting an error. For message receive monitor resources, select "Restart the recovery target", "Executing failover to the recovery target", or "Execute the final action" as the action to take when an error is detected. However, if the recovery target is inactive, the recovery action is not performed.

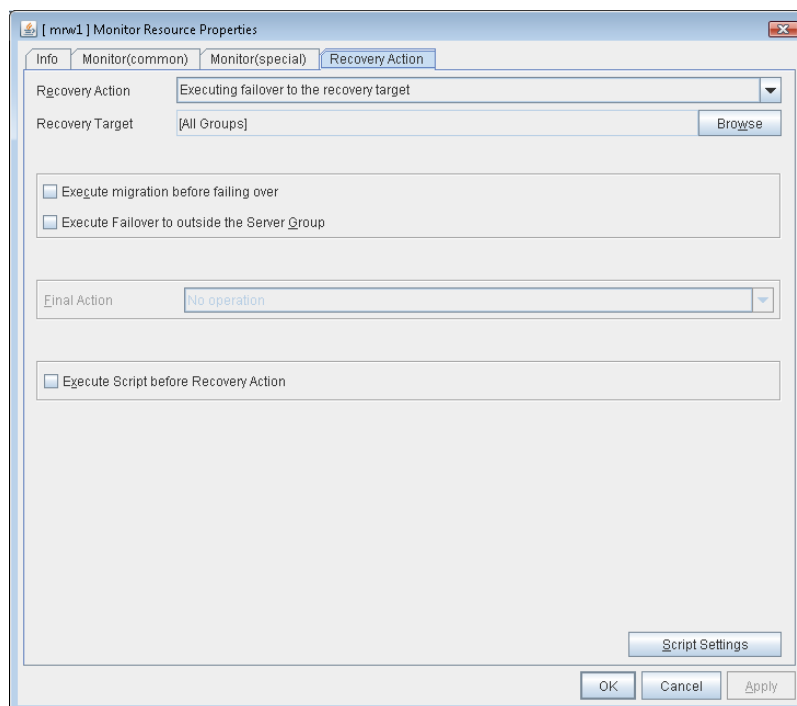

### Recovery Action

Select the action to take when a monitor error is detected.

- ◆ Executing recovery script  
Let the recovery script run upon the detection of a monitor error.
- ◆ Restart the recovery target  
Restart the group or group resource selected as the recovery target when a monitor error is detected.
- ◆ Executing failover to the recovery target  
Perform a failover for the group selected as the recovery target or the group to which the group resource selected as the recovery target belongs when a monitor error is detected.
- ◆ Execute the final action  
Execute the selected final action when a monitor error is detected.

**Execute Failover to outside the Server Group**

Configurable only for message receive monitor resources. Specify whether to fail over to a server group other than the active server group upon the reception of an error message.

**Execute Script before Recovery Action**

This setting is disabled when linking with the server management infrastructure. Execute the script before the operation to be performed upon error detection, as selected for the recovery action.

- \* For details about the settings other than the above, see “Displaying and changing the settings of the time when an error is detected by a monitor resource (Common to monitor resources)” in Chapter 6, “Monitor resource details.”





# Section III Maintenance information

This section provides information on operation and maintenance of the EXPRESSCLUSTER system.

- Chapter 10 The system maintenance information
- Chapter 11 Troubleshooting
- Chapter 12 Error messages



# Chapter 10 The system maintenance information

This chapter provides information you need for maintenance of your EXPRESSCLUSTER system. Resources to be managed are described in detail.

This chapter covers:

- Directory structure of EXPRESSCLUSTER ..... 1280
- Log structure of EXPRESSCLUSTER..... 1283
- How to delete EXPRESSCLUSTER logs or alerts ..... 1285
- Mirror statistics information collection function ..... 1286
- Communication ports ..... 1292
- Cluster driver device information ..... 1295
- What causes servers to shut down ..... 1296
- Configuring the settings to temporarily prevent execution of failover ..... 1301
- How to replace a mirror disk with a new one ..... 1303
- How to replace a server with a new one ~For a shared disk~ ..... 1311
- How to replace a server with a new one ~For a mirror disk~ ..... 1313
- How to replace a server with a new one ~For a hybrid disk~ ..... 1323
- Wait time for synchronized cluster startup ..... 1332
- Changing disk resources file system..... 1333
- Changing offset or size of a partition on mirror disk resource ..... 1335
- Changing offset or size of a partition on hybrid disk resource ..... 1345
- Changing the server configuration (add/delete)..... 1356
- Changing the server IP address..... 1360
- Changing the host name ..... 1362
- How to add a resource without stopping the group ..... 1363

# Directory structure of EXPRESSCLUSTER

**Note:**

Executable files and script files that are not described in Chapter 3, “EXPRESSCLUSTER command reference” in this guide can be found under the installation directory. Run these files only with EXPRESSCLUSTER. Any failure or trouble caused by executing them by applications other than EXPRESSCLUSTER is not supported.

EXPRESSCLUSTER directories are structured as described below:

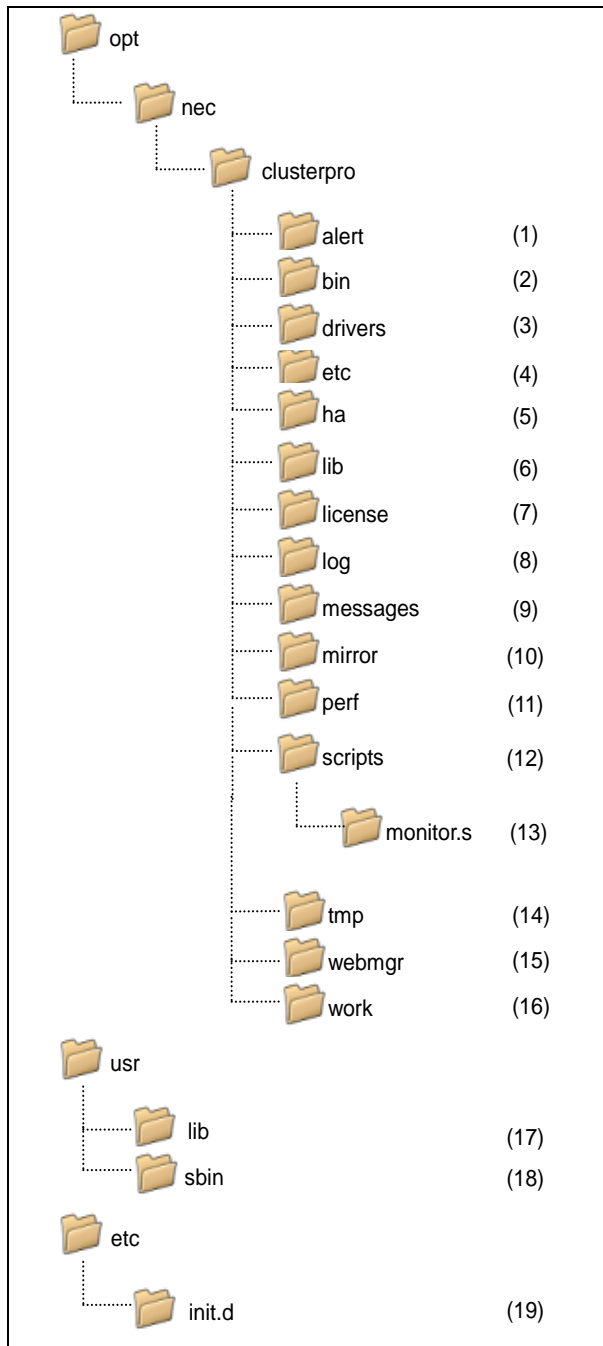

1. Directory for alert synchronization  
This directory stores EXPRESSCLUSTER Alert Synchronization's modules and management files.
2. Directory for cluster modules  
This directory stores the EXPRESSCLUSTER Server's executable files.
3. Directory for cluster drivers
  - Mirror driver  
This directory stores the executable files of the data mirror driver.
  - Kernel mode LAN heartbeat, keepalive driver  
This directory stores the executable files of the kernel mode LAN heartbeat and keepalive driver.
4. Directory for cluster configuration data  
This directory stores the cluster configuration files and policy file of each module.
5. Directory for HA products linkage  
This directory stores binaries and configuration files for the Java Resource Agent and System Resource Agent.
6. Directory for cluster libraries  
This directory stores the EXPRESSCLUSTER Server's library.
7. Directory for licenses  
This directory stores licenses for licensed products.
8. Directory for module logs  
This directory stores logs produced by each module.
9. Directory for report messages (alert, syslog, mail)  
This directory stores alert, syslog and mail messages reported by each module.
10. Directory for mirror disk and hybrid disk  
This directory stores the executable files and policy files etc. of the modules for mirror disk and hybrid disk.
11. Directory for the performance logs  
This directory stores the information of performance about disk and system.
12. Directory for EXEC resource script of group resources  
This directory stores EXEC resource scripts of group resources.
13. Directory for the recovery script  
This directory stores the script executed by this function when an error is detected in the monitor resource if execution of a recovery script is in effect.
14. Directory for temporary files  
This directory stores archive files created when logs are collected.
15. Directory for the WebManager  
This directory stores the EXPRESSCLUSTER WebManager's modules and management files.
16. Directory for module tasks

This is a work directory for modules.

**17.** /usr/lib (usr/lib64)

This directory stores the symbolic links to the EXPRESSCLUSTER Server's library. When the architecture of the EXPRESSCLUSTER Server is x86\_64, IBM POWER or IBM POWER LE, this directory is /usr/lib64.

**18.** /usr/sbin

This directory stores the symbolic links to the EXPRESSCLUSTER Server's executable files.

**19.** /etc/init.d

This directory stores the EXPRESSCLUSTER Server's Start/Stop scripts.

## Log structure of EXPRESSCLUSTER

The log directory in the EXPRESSCLUSTER installation directory has the following structure:

### (1) EXPRESSCLUSTER service logs

The EXPRESSCLUSTER service logs include the following types and generations.

init\_\*.start.cur: Log collected when the current service started  
 init\_\*.start.pre: Log collected when the service one generation older started  
 init\_\*.stop.cur: Log collected when the current service stopped  
 init\_\*.stop.pre: Log collected when the service one generation older stopped

- \* represents a character string specific to each service.
  - evt: clusterpro\_evt
  - trn: clusterpro\_trn
  - md: clusterpro\_md
  - main: clusterpro
  - webmgr: clusterpro\_webmgr
  - alert: clusterpro\_alertsync
- The log level and size cannot be changed.
- Two generations are automatically rotated. Generations older than the second are removed, starting with the oldest data.

### (2) Internal logs for each module

The EXPRESSCLUSTER internal logs include the following types and generations for each module.

\*.log.cur: Current internal log  
 \*.log.pre: Internal log one generation older  
 \*.err.cur: Current error log  
 \*.err.pre: rror log one generation older

- \* represents the module name. For the module list, see “Modifying the log level and size (clplogcf command)” in Chapter 3, “EXPRESSCLUSTER command reference” in this guide.
- Two generations are automatically rotated. Generations older than the second are removed, starting with the oldest data.

### (3) Logs for error occurrence

These logs are used to collect emergency information when an error occurs during EXPRESSCLUSTER processing.

For details on collection, see “Collecting logs (clplogcc command) Collecting information when a failure occurs” in Chapter 3, “EXPRESSCLUSTER command reference” in this guide.

elog\_\*0.tar.gz: Current log collected when errors occurred  
 elog\_\*1.tar.gz: Previous-generation error log  
 :  
 elog\_\*4.tar.gz: Four generations old error log

- \* represents the module name.
  - pm: When an EXPRESSCLUSTER service starts or stops
  - rc: When an a group resource activation or deactivation error occurred
  - rm: When a monitor resource error is detected

- Error occurrence information is saved for five generations (10 generations for rm only). For the fifth and older generations, information is discarded, starting from the oldest.
- The log level and size cannot be changed.



## How to delete EXPRESSCLUSTER logs or alerts

To delete EXPRESSCLUSTER logs or alerts, perform the following procedure.

- (1) Run `chkconfig --del name` on all the servers in the cluster to disable the following services in the order shown.
  - clusterpro\_alertsync
  - clusterpro\_webmgr
  - clusterpro
  - clusterpro\_md
  - clusterpro\_trn
  - clusterpro\_evt
- (2) Shut down the cluster with the WebManager or `clpstdn` command, and then reboot the cluster.
- (3) To delete logs, delete the files and directories in the following directory. Perform this operation on the server for which you want to delete the logs.
  - /opt/nec/clusterpro/log/
- (4) To delete alerts, delete the files in the following directory. Perform this operation on the server for which you want to delete the alerts.
  - /opt/nec/clusterpro/alert/log/
- (5) Run `chkconfig --add name` on all the servers in the cluster to enable the following services in the order shown.
  - clusterpro\_evt
  - clusterpro\_trn
  - clusterpro\_md
  - clusterpro
  - clusterpro\_webmgr
  - clusterpro\_alertsync
- (6) Run the `reboot` command on all the servers in the cluster to reboot the cluster.

## Mirror statistics information collection function

If the **Gather Statistical information** check box is already checked on the **Mirror Agent** tab of **Cluster Properties** in Builder, information on the mirror performance is collected and saved to *install\_path/perf/disk* according to the following file naming rules. In the following explanations, this file is represented as the mirror statistics information file.

<b>nmpN.cur</b> <b>nmpN.pre[X]</b>	
cur	Indicates the latest information output destination.
pre	Indicates the previous, rotated, information output destination.
N	Indicates the target NMP number.
[X]	Indicates the generation number. For a file that is one generation older, the generation number is omitted. For a file that is m generations older, X is assumed to be m-1. If the total number of generations is n, X of the oldest file is assumed to be n-2.

The collected information is saved to the mirror statistics information file. The time during which statistics information is output to this file (=sampling interval) is 60 seconds. If the size of current log file reached 16MB, it is rotated to new log file. And two generation log files can be saved. Information recorded to the mirror statistics information file can be used as a reference for the tuning related to the mirror function. The collected statistics information contains the following items.

---

**Note:**

- Mirror statistics information is not collected by `clplogcc` command or WebManager.
-

Statistic value name	Unit (*1)	Description	Output (*2)
Write, Total (Write amount)	Byte (MB)	Total amount of data written to the mirror partition The value to be output is the amount of data written by every sampling.	LOG, CMD (A)
Write, Avg (Write amount, average value)	Byte/s (MB/s)	Amount of data written to the mirror partition per unit time	LOG, CMD (A)
Read, Total (Read amount)	Byte (MB)	Total amount of data read from the mirror partition The value to be output is the amount of data read by every sampling.	LOG, CMD (A)
Read, Avg (Read amount, average value)	Byte/s (MB/s)	Amount of data read from the mirror partition per unit time	LOG, CMD (A)
Local Disk Write, Total (Local disk write amount)	Byte	Total amount of data written to the local disk (data partition) The value to be output is the amount of data written by every sampling.	LOG (B)
Local Disk Write, Avg (Local disk average write amount)	Byte/s	Amount of data written to the local disk (data partition) per unit time	LOG (B)
Local Disk Read, Total (Local disk read amount)	Byte	Total amount of data read from the local disk (data partition) The value to be output is the amount of data read by every sampling.	LOG (B)
Local Disk Read, Avg (Local disk average read amount)	Byte/s	Amount of data read from the local disk (data partition) per unit time	LOG (B)
Send, Total (Mirror communication amount, total value)	Byte (KB)	Total amount of mirror communication sent up until mirror disk connect The value to be output is the communication amount by every sampling. TCP control information and the like are excluded.	LOG, CMD (B)
Send, Avg (Mirror communication amount, average value)	Byte/s (KB/s)	Mirror communication amount sent by up until mirror disk connect per unit time	LOG, CMD (B)
Compress Ratio (Compression ratio)	%	Mirror data compression ratio (Post-compression size) / (pre-compression size) x 100  100 for noncompression The value to be output is calculated based on the communication data for every sampling.	LOG (A)

Statistic value name	Unit (*1)	Description	Output (*2)
Sync Time, Max (Mirror communication time, maximum value)	Second/time	<p>Time needed until the first piece of mirror synchronization data is synchronized. (*3) The value to be output is the longest mirror synchronization data time.</p> <p>Mirror synchronization data that failed to be synchronized due to non-communication or the like (resulting in a mirror break) is excluded.</p> <p>Moreover, the value to be output is obtained for communication for every sampling.</p>	LOG, CMD (A)
Sync Time, Avg (Mirror communication time, average value)	Second/time	<p>Time needed until the first piece of mirror synchronization data is synchronized. (*3) The value to be output is the average for all the communications.</p> <p>Mirror synchronization data that failed to be synchronized due to non-communication or the like (resulting in a mirror break) is excluded.</p> <p>Moreover, the value to be output is obtained for communication for every sampling.</p>	LOG, CMD (A)
Sync Ack Time, Max (Mirror synchronization ACK response time, maximum value)	Millisecond	<p>Time that elapses between mirror synchronization data being sent to the other server and ACK being received from the other server. (*3) The maximum value of all such times is output.</p> <p>This value is used as a reference to determine <b>Ack Timeout</b> of the <b>Mirror Driver</b> tab that is set with the mirror disk resource or hybrid disk resource.</p> <p>However, mirror synchronization data that results in an ACK timeout is excluded from the measurement.</p> <p>The value to be output is the time after the mirror daemon (mirror agent) starts.</p>	LOG (A)
Sync Ack Time, Cur (Mirror synchronization ACK response time, latest value)	Millisecond	<p>Of the lengths of time needed for mirror synchronization data ACK reception, this value is the time that needed for the most recent ACK reception. (*3)</p> <p>However, mirror synchronization data that results in an ACK timeout is excluded from the measurement.</p>	LOG (A)

Statistic value name	Unit (*1)	Description	Output (*2)
Recovery Ack Time, Max (Mirror recovery ACK response time, maximum value)	Millisecond	<p>Time that elapses between mirror recovery data being sent to the other server and ACK being received from the other server</p> <p>The maximum value of all such times is output.</p> <p>This value is used as a reference to determine <b>Ack Timeout</b> of the <b>Mirror Driver</b> tab that is set with the mirror disk resource or hybrid disk resource.</p> <p>However, mirror synchronization data that results in an ACK timeout is excluded from the measurement.</p> <p>The value to be output is the time after the mirror daemon (mirror agent) starts.</p>	LOG (A)
Recovery Ack Time, Cur (Mirror recovery ACK response time, latest value)	Millisecond	<p>Time that elapses between the mirror recovery data being sent to the other server and ACK being received from the other server</p> <p>The value to be output is the time needed for the most recent ACK reception.</p> <p>However, mirror synchronization data that results in an ACK timeout is excluded from the measurement.</p>	LOG (A)
Sync Diff, Max (Difference amount, maximum value)	Byte (MB)	<p>Amount of mirror synchronization data that has not yet been synchronized with the other server. The value to be output is the maximum from among all the samplings.</p> <p>Mirror synchronization data that failed to be synchronized due to non-communication or the like (resulting in a mirror break) is excluded.</p>	LOG, CMD (A)
Sync Diff, Cur (Difference amount, latest value)	Byte (MB)	<p>Amount of mirror synchronization data that has not yet been synchronized with the other server. The value to be output is that which was used most recently for collection.</p> <p>Mirror synchronization data that failed to be synchronized due to non-communication or the like (resulting in a mirror break) is excluded.</p>	LOG, CMD (A)
Send Queue, Max (Number of send queues, maximum value)	Quantity	<p>Number of queues used when mirror synchronization data is sent. The value to be output is the maximum used after the mirror daemon (mirror agent) starts.</p> <p>This value is used as a reference to determine <b>Number of Queues</b> in <b>Asynchronous</b> mode that is set with the mirror disk resource or hybrid disk resource.</p>	LOG (A)
Send Queue, Cur (Number of send queues, latest value)	Quantity	<p>Number of queues used when mirror synchronization data is sent. The value to be output is that which was used most recently for collection.</p>	LOG (A)

Statistic value name	Unit (*1)	Description	Output (*2)
Request Queue, Max (Number of request queues, maximum value)	Quantity	Number of I/O requests being processed that were sent to the mirror partition. The value to be output is the maximum used after the mirror daemon (mirror agent) starts.  This value is used as a reference to determine <b>Request Queue Maximum Number</b> of the <b>Mirror Driver</b> tab of cluster properties.	LOG (A)
Request Queue, Cur (Number of request queues, latest value)	Quantity	Number of I/O requests being processed that were sent to the mirror partition. The value to be output is that which was used most recently for collection.	LOG (A)
MDC HB Time Max (Mirror disconnect heartbeat time, maximum value)	Second	Time that elapses between ICMP ECHO being sent to the other server through mirror disconnect and ICMP ECHO REPLY being received from the other server.  The value to be output is the maximum used after the mirror daemon (mirror agent) starts.	LOG (B)
MDC HB Time Cur (Mirror disconnect heartbeat time, latest value)	Second	Time that elapses between ICMP ECHO being sent to the other server through mirror disconnect and ICMP ECHO REPLY being received from the other server.  The value to be output is that which was used most recently for collection.	LOG (B)
Local-Write Waiting Recovery-Read Time, Total (Mirror synchronization I/O exclusion time, total value)	Second	If writing to the same area of the disk occurs during mirror recovery, writing is held until the mirror recovery for that area is complete.  The value to be output is the cumulative value of the hold time, from when the mirror daemon (mirror agent) starts.  That hold time may be long if <b>Recovery Data Size</b> of the <b>Mirror Agent</b> tab of the cluster properties is made large. This value is used as a reference to determine this size.	LOG (A)
Recovery-Read Waiting Local-Write Time, Total (Mirror recovery I/O exclusion time, total value)	Second	If reading of mirror recovery data from the same area of the disk occurs during writing to the mirror partition, reading of the mirror recovery data is held until writing to that area is complete.  The value to be output is the cumulative value of the hold time, from when the mirror daemon (mirror agent) starts.  That hold time may be long if <b>Recovery Data Size</b> of the <b>Mirror Agent</b> tab of the cluster properties is made large. This value is used as a reference to determine this size.	LOG (A)

Statistic value name	Unit (*1)	Description	Output (*2)
Unmount Time, Max (Unmount time, maximum value)	Second	Time needed for unmount to be executed when the mirror disk resource or hybrid disk resource is deactivated  This value is used as a reference to determine <b>Timeout</b> of the <b>Unmount</b> tab that is set with the mirror disk resource or hybrid disk resource.	LOG (A)
Unmount Time, Last (Unmount time, latest value)	Second	Time needed for unmount to be executed when the mirror disk resource or hybrid disk resource is deactivated  The value to be output is the time needed when unmount was most recently executed.	LOG (A)
Fsck Time, Max (fsck time, maximum value)	Second	Time needed for fsck to be executed when the mirror disk resource or hybrid disk resource is activated  This value is used as a reference to determine <b>fsck Timeout</b> of the <b>Fsck</b> tab that is set with the mirror disk resource or hybrid disk resource.	LOG (A)
Fsck Time, Last (fsck time, latest value)	Second	Time needed for fsck to be executed when the mirror disk resource or hybrid disk resource is activated  The value to be output is the time needed when fsck was most recently executed.	LOG (A)

\*1 The unit in parentheses is used for command display. During output, a value of up to two decimal places is output. The third decimal place is truncated.  
The conversion rules are as follows:  
1 KB = 1024 bytes, 1 MB = 1048576 bytes  
If a value is truncated to 0, "0.00" is output. If the value is 0 without truncation, "None" is displayed for commands, or "0" for the mirror statistics information file.

\*2 CMD ... Information that is visible with commands (clpmdstat, clphdstat)  
LOG ... Information that is output to the mirror statistics information file  
(A) ... In case of Active, the valid value is output.  
(B) ... In both cases of Active/Standby, the valid value is output.

Further, only mirror statistics information on a local server is recorded, information on other servers is not recorded.

\*3 If the mode is "synchronous", "time taken from sending a mirror synchronous data to receiving ACK from the other server".  
If the mode is "asynchronous", "time taken from placing mirror synchronous data on the synchronization queue to receiving ACK from the other server".

◆ If **Gather Statistical information** is already checked, part of information (information with CMD in the Output column in the above table) can be collected and displayed with the clpmdstat/clphdstat command. For information on how to use this command, see "EXPRESSCLUSTER command reference" (clpmdstat command) in this guide.

Display with commands can be used only when **Gather Statistical information** is already enabled in the **Mirror Agent** tab of **Cluster Properties** in Builder.

## Communication ports

EXPRESSCLUSTER uses several port numbers. Change the firewall settings so that EXPRESSCLUSTER can use some port numbers.

The following is the list of port numbers used in EXPRESSCLUSTER:

Server to Server (Loopback in Server)						
From				To		Used for
Server	Automatic allocation <sup>1</sup>	→	Server	29001/TCP	Internal communication	
Server	Automatic allocation	→	Server	29002/TCP	Data transfer	
Server	Automatic allocation	→	Server	29002/UDP	Heartbeat	
Server	Automatic allocation	→	Server	29003/UDP	Alert synchronization	
Server	Automatic allocation	→	Server	29004/TCP	Communication between mirror agents	
Server	Automatic allocation	→	Server	29006/UDP	Heartbeat (kernel mode)	
Server	Automatic allocation	→	Server	XXXX <sup>2</sup> /TCP	Mirror disk resource data synchronization	
Server	Automatic allocation	→	Server	XXXX <sup>3</sup> /TCP	Communication between mirror drivers	
Server	Automatic allocation	→	Server	XXXX <sup>4</sup> /TCP	Communication between mirror drivers	
Server	icmp	→	Server	icmp	keepalive between mirror drivers Duplication check of FIP/VIP resource Mirror agent	
Server	Automatic allocation	→	Server	XXXX <sup>5</sup> /UDP	Internal communication for log	

WebManager to Server						
From				To		Used for
WebManager	Automatic allocation	→	Server	29003/TCP	http communication	

Server connected to the Integrated WebManager to target server						
From				To		Used for
Server connected to the Integrated WebManager	Automatic allocation	→	Server	29003/TCP	http communication	
Server to be managed by the Integrated WebManager	29003	→	Client	29010/UDP	UDP communication	



Others					
From			To		Used for
Server	Automatic allocation	→	Network warning light	514/TCP	Network warning light control
Server	Automatic allocation	→	BMC Management LAN of the server	623/UDP	BMC control (Forced stop/chassis identify)
BMC Management LAN of the server	Automatic allocation	→	Server	162/UDP	Monitoring target of the external linkage monitor set for BMC identify
BMC Management LAN of the server	Automatic allocation	→	BMC Management LAN of the server	5570/UDP	BMC HB communication
Server	icmp	→	Monitoring target	icmp	IP monitor
Server	icmp	→	NFS Server	icmp	Monitoring if NFS server of NAS resource is active
Server	icmp	→	Monitoring target	icmp	Monitoring target of PING method of network partition resolution resource
Server	Automatic allocation	→	Server	Management port number <sup>6</sup> set by Builder	JVM monitor
Server	Automatic allocation	→	Monitoring target	Connection port number <sup>7</sup> set by Builder	JVM monitor
Server	Automatic allocation	→	Monitoring target	Load balancer linkage management port number <sup>8</sup> set by Builder	JVM monitor
Server	Automatic allocation	→	BIG-IP LTM	Communication port number <sup>9</sup> set by Builder	JVM monitor
Server	Automatic allocation	→	Server	Probe port set by the Builder <sup>10</sup>	Azure probe port resource

1. In automatic allocation, a port number not being used at a given time is allocated.
2. This is a port number used on a mirror disk/hybrid disk resource basis and is set when creating mirror disk resource or hybrid disk. A port number 29051 is set by default. When you

add a mirror disk resource or hybrid disk, this value is automatically incremented by 1. To change the value, click **Detail** tab of **Mirror Disk Resource Properties** or **Hybrid Disk Resource Properties** in the Builder. For more information, see Chapter 4, “Group resource details” in this guide.

3. This is a port number used on a mirror disk resource/hybrid disk basis and is set when creating mirror disk resource or hybrid disk. A port number 29031 is set by default. When you add a mirror disk resource or a hybrid disk, this value is automatically incremented by 1. To change the value, click **Detail** tab of **Mirror Disk Resource Properties** or **Hybrid Disk Resource Properties** in the Builder. For more information, see Chapter 4, “Group resource details” in this guide.
4. This is a port number used on a mirror disk resource/hybrid disk basis and is set when creating mirror disk resource or hybrid disk. A port number 29071 is set by default. When you add a mirror disk resource/hybrid disk, this value is automatically incremented by 1. To change the value, click **Detail** tab of **Mirror Disk Resource Properties** or **Hybrid Disk Resource Properties** in the Builder. For more information, refer to Chapter 4, “Group resource details” in Reference Guide.
5. In the **Port Number (log)** tab in **Cluster Properties**, select **UDP** for log communication, and use the port number configured at Port Number. The default log communication method, **UNIX Domain**, does not use a communication port.
6. The management port number is used to communicate with the Java VM on which the JVM monitor runs. It is set with **Cluster Properties** in the Builder - **JVM monitor** tab - **Connection Setting** dialog box. For details, see Chapter 2, “Functions of the Builder” in this guide.
7. The connection port number is used to connect to Java VM of the monitoring target (WebLogic Server, WebOTX). It is set with the **Monitor(special)** tab of **Properties** of the relevant JVM monitor resource name in the Builder. For details, see Chapter 5, “Monitor resource details” in this guide.
8. The load balancer linkage management port number is used to perform load balancer linkage. It need not be set if no load balancer linkage is used. It is set with **Cluster Properties** in the Builder - **JVM monitor** tab - **Load Balancer Linkage Settings** dialog box. For details, see Chapter 2, “Functions of the Builder” in this guide.
9. The communication port number is the port number used to perform load balancer linkage with BIG-IP LTM. If you are not using load balancer linkage, there is no need to set this. It is set with the **Load Balancer Linkage Setting** dialog box - **JVM monitor** tab - **Cluster Properties** in the Builder. For details see Chapter 2, “Functions of the Builder” in this guide.
10. Port number used by the Azure load balancer for the alive monitoring of each server.

## Cluster driver device information

- The mirror driver mainly uses 218 as the major number. Make sure that no other driver uses this major number. However, this major number can be changed to avoid using 218 due to system restrictions.
- The kernel mode LAN heartbeat driver uses 10 as the major number, and mainly uses 240 as the minor number. Make sure that no other driver uses these major and minor numbers.
- The keepalive driver uses 10 as the major number, and mainly uses 241 as the minor number. Make sure that no other driver uses these major and minor numbers.

## What causes servers to shut down

When any one of the following errors occurs, EXPRESSCLUSTER shuts down, resets servers, or performs panic of servers to protect resources.

### Final action for an error in resource activation or deactivation

When the final action for errors in resource activation/deactivation is specified as one of the following:

Final action	Result
The cluster service stops and the OS shuts down.	Causes normal shutdown after the group resources stop.
The cluster service stops and the OS reboots.	Causes normal reboot after the group resources stop.
Sysrq Panic	Performs a panic upon group resource activation/deactivation error.
Keepalive Reset	Performs a reset upon group resource activation/deactivation error.
Keepalive Panic	Performs a panic upon group resource activation/deactivation error.
BMC Reset	Performs a reset upon group resource activation/deactivation error.
BMC Power Off	Performs a power off upon group resource activation/deactivation error.
BMC power Cycle	Performs a power cycle upon group resource activation/deactivation error.
BMC NMI	Causes NMI upon group resource activation/deactivation error.
I/O Fencing(High-End Server Option)	Causes I/O fencing upon group resource activation/deactivation error.

### Action for resource activation or deactivation stall generation

When one of the following is specified as the final action to be applied upon the occurrence of an error in resource activation/deactivation, and if resource activation/deactivation takes more time than expected:

Action performed when a stall occurs	Result
The cluster service stops and the OS shuts down.	When a group resource activation/deactivation stall occurs, performs normal shutdown after the group resources stop.
The cluster service stops and the OS reboots.	When a group resource activation/deactivation stall occurs, performs normal reboot after the group resources stop.
Sysrq Panic	When a group resource activation/deactivation stall occurs, performs a panic.
Keepalive Reset	When a group resource activation/deactivation stall occurs, performs a reset.
Keepalive Panic	When a group resource activation/deactivation stall occurs, performs a panic.

Action performed when a stall occurs	Result
BMC Reset	When a group resource activation/deactivation stall occurs, performs a reset.
BMC Power Off	When a group resource activation/deactivation stall occurs, performs a power off.
BMC power Cycle	When a group resource activation/deactivation stall occurs, performs a power cycle.
BMC NMI	When a group resource activation/deactivation stall occurs, performs an NMI.
I/O fencing(High-End Server Option)	When a group resource activation/deactivation stall occurs, performs an I/O fencing.

The OS shuts down if the resource activation or deactivation takes an unexpectedly long time. The OS shuts down, regardless of the setting of recovery in the event of a resource activation or deactivation error.

If a resource activation stall occurs, alert occurs and the following message is output to syslog.

Module type: rc

Event ID: 32

Message: Activating %1 resource has failed.(99 : command is timeout)

Description: Failed to activate 1 resource.

If a resource deactivation stall occurs, alert occurs and the following message is output to syslog.

Module type: rc

Event ID: 42

Message: Stopping %1 resource has failed.(99 : command is timeout)

Description: Failed to stop the %1 resource.

## Final action at detection of an error in monitor resource

When the final action for errors in monitor resource monitoring is specified as one of the following:

Final action	Result
Stop cluster service and shut down the OS	Causes shutdown after the group resources stop.
Stop cluster service and reboot the OS	Causes reboot after the group resources stop.
Sysrq Panic	Causes panic when an error is detected in monitor resource.
Keepalive Reset	Causes reset when an error is detected in monitor resource.
Keepalive Panic	Causes panic when an error is detected in monitor resource.
BMC Reset	Causes reset when an error is detected in monitor resource.
BMC Power Off	Causes power off when an error is detected in monitor resource.
BMC Power Cycle	Causes power cycle when an error is detected in monitor resource.
BMC NMI	Causes NMI when an error is detected in monitor resource.
I/O Fencing(High-End Server Option)	Causes I/O fencing when an error is detected in monitor resource.

## Forced stop action

When forced stop is configured as “Used”.

### ◆ Physical machine

Final action	Result
BMC reset	Causes reset in the failing server in which a failover group existed.
BMC power off	Causes power off in the failing server in which a failover group existed.
BMC power cycle	Causes power cycle in the failing server in which a failover group existed.
BMC NMI	Causes NMI in the failing server in which a failover group existed.

### ◆ Virtual machine (guest OS)

Final action	Result
VMware vSphere CLI power off	Causes power off in the failing server in which a failover group existed.

## Emergency server shutdown, emergency server reboot

When an abnormal termination is detected in any of the following processes, a shutdown or reboot is generated after the group resource stops. Shutdown or reboot generation depends on the setting of **Action When the Cluster Service Process Is Abnormal**.

- clprc
- clprm
- clpnm

## Resource deactivation error in stopping the EXPRESSCLUSTER daemon

When deactivating a resource by running `clpcl -t`, which stops the EXPRESSCLUSTER daemon fails, EXPRESSCLUSTER causes a emergency shutdown. An action for emergency shutdown depends on the settings in [Action When the Cluster Service Process Is Abnormal].

## Stall detection in user space

When a server stalls longer than the heartbeat time-out, an OS hardware reset, panic, or I/O fencing is generated. Hardware reset or panic generation depends on the setting of **Operation at Timeout Detection** of the user-mode monitor resource.

## Stall detection during shutdown process

When a server stalls during the OS shutdown process, an OS hardware reset, panic, or I/O fencing is generated. Hardware reset or panic generation depends on the setting of **Operation at Timeout Detection** of the shutdown monitor.

## Recovery from network partitioning

When any network partition resolution resources are not set, if all heartbeats are disrupted (network partitioning), both servers failover to each other. As a result, groups are activated on both servers. Even when network partition resolution resources are set, groups may be activated on both servers.

If interconnections are recovered from this condition, EXPRESSCLUSTER causes shutdown on both or one of the servers.

For details of network partitioning, see “When network partitioning occur” on page 1374.

## Network partition resolution

In a cluster system where network partition resolution resources are configured, the network partition resolution is performed when all heartbeats are interrupted (network partition). If this is determined to be caused by the network partitions, some or all of the servers are shut down or stop their services. Shutdown or service stop generation depends on the setting of **Action at NP Occurrence**.

For details on the network partition resolution, see Chapter 7, “Network partition resolution resources details” in this guide.

## **Mirror disk error ~For Replicator~**

When an error occurs in a mirror disk, the mirror agent causes reset.

## **Hybrid disk error ~For Replicator DR~**

When an error occurs in a hybrid disk, the mirror agent causes reset.

## **Failure in resuming the cluster**

If resuming the cluster fails, the server is shut down.



## Configuring the settings to temporarily prevent execution of failover

Follow the steps below to temporarily prevent failover caused by a failed server from occurring.

- ◆ Temporarily adjust time-out

By temporarily adjusting time-out, you can prevent a failover caused by a failed server from occurring.

The `clptoratio` command is used to temporarily adjust time-out. Run the `clptoratio` command on one of the servers in the cluster.

(Example) To extend the heartbeat time-out to an hour, or 3600 seconds, when the heartbeat time-out is set to 90 seconds:

```
clptoratio -r 40 -t 1h
```

For more information on the `clptoratio` command, see “Adjusting time-out temporarily (`clptoratio` command)” in Chapter 3, “EXPRESSCLUSTER command reference” in this guide.

- ◆ Releasing temporary time-out adjustment

Releases the temporary adjustment of time-out. Execute the `clptoratio` command for any server in the cluster.

```
clptoratio -i
```

For more information on the `clptoratio` command, see “Adjusting time-out temporarily (`clptoratio` command)” in Chapter 3, “EXPRESSCLUSTER command reference” in this guide.

Follow the steps below to temporarily prevent failover caused by a monitor error by temporarily stopping monitor resource monitoring.

- ◆ Suspending monitoring operation of monitor resources

By suspending monitoring operations, a failover caused by monitoring can be prevented.

The `clpmonctrl` command is used to suspend monitoring. Run the `clpmonctrl` command on all servers in the cluster.

(Example) To suspend all monitoring operations:

```
clpmonctrl -s
```

For more information on the `clpmonctrl` command, see “Controlling monitor resources (`clpmonctrl` command)” in Chapter 3, “EXPRESSCLUSTER command reference” in this guide.

- ◆ Restarting monitoring operation of monitor resources

Resumes monitoring. Execute the `clpmonctrl` command for all servers in the cluster.

(Example) Resuming all monitoring operations:

```
clpmonctrl -r
```

For more information on the `clpmonctrl` command, see “Controlling monitor resources (`clpmonctrl` command)” in Chapter 3, “EXPRESSCLUSTER command reference” in this guide.

Follow the steps below to temporarily prevent failover caused by a monitor error by suppressing the recovery operation for a monitor resource error.

◆ Suppressing recovery operation upon a monitor resource error

If suppression of recovery operation upon a monitor resource error is set, the monitor resource does not perform recovery even if it detects an error. To set this function, check **Inhibit the recovery action** on the **Recovery** tab in **Cluster Properties** on the Builder. The setting is applied.

◆ Suppressing no recovery operation upon a monitor resource error

The setting specifying suppression of the recovery operation upon a monitor resource error is released. To set this function, uncheck **Inhibit the recovery action** on the **Recovery** tab in **Cluster Properties** on the Builder. The setting is applied.

## How to replace a mirror disk with a new one

When the replacement of mirror disks is necessary due to mirror disk breakdown or some reasons after starting operation, run the following steps:

---

### Related Information:

For details on how to stop and start daemons, see “Suspending EXPRESSCLUSTER” in Chapter 9, “Preparing to operate a cluster system” in the *Installation and Configuration Guide*.

---

### In case of replacing a mirror disk constructed with a single disk(non-RAID)

1. Stop the server of which the mirror disk is going to be replaced.

---

#### Note:

- Before shutting down the server, it is recommended that the steps in “Disabling the EXPRESSCLUSTER daemon” in the *Installation and Configuration Guide* be executed.

On the server on which to disable the daemon, execute the command in the order below to disable the daemon.

```
chkconfig --del clusterpro_alertsync
chkconfig --del clusterpro_webmgr
chkconfig --del clusterpro
chkconfig --del clusterpro_md
```

- If a hybrid disk failure occurs, terminate all servers connected to the disk to be replaced.
- 

2. Install a new disk in the server.
3. Start up the server in which the new disk was installed. At this time, change the setting so that the EXPRESSCLUSTER services will not be executed. In case of not having disabled the EXPRESSCLUSTER daemon in the step 1, the daemons start up in single user mode at OS startup.
4. Construct the same partition as the original disk to the new disk by fdisk command.

---

#### Note:

- To replace shared storage with the hybrid disk, create a partition and file system with any server connected to that shared storage.
  - Initialize the cluster partition when using the disk used as an EXPRESSCLUSTER mirror disk or hybrid disk with data discarded.
  - For more information on initializing the cluster partition (CLUSTER partition), see the related items (“Shared disk settings for hybrid disk resource”, “Partition settings for hybrid disk resource”, and “Partition settings for mirror disk resource”) in “Settings after configuring hardware” in Chapter 1, “Determining a system configuration” in the *Installation and Configuration Guide*.
- 

5. Prevent initial mirror construction from being performed automatically.
  - ◆ (A) For the version **X3.1.8-1 or later**, if, in the **state in which the operation is being performed** on the server on which a mirror disk **is not replaced** (state in which the group containing mirror disk resources is active), you want to concurrently perform

disk copy (initial mirror construction), there is no particular need to make sure that initial mirror construction is not automatically performed.

- ◆ (B) For a version between **X3.0.0-1 and X3.1.7-2**, if, in the **state in which the operation is being performed** on the server on which a mirror disk **is not replaced** (state in which the group containing mirror disk resources is active), you want to concurrently perform disk copy (initial mirror construction), use the WebManager or the `clpmonctrl` command to suspend the mirror disk monitor resource that is monitoring the mirror disk resources. (This prevents initial mirror construction, described later, from being performed automatically.)
- ◆ (C) If the operation could be stopped until disk copy is completed (the group may be deactivated), deactivate the group containing the mirror disk resource.

---

**Note:**

- With **procedure (A)**, copy is performed by the amount equal to that of disk space used, depending on the type of file system, so the copy time may depend on the amount of disk space used.  
Also, because the operation and copy are performed concurrently, the load may become high and copy may take time depending on the case.
  - With **procedure (B)** whereby disk copy is performed while the operation is being performed (the group is kept active), copy is performed by the amount equal to the mirror disk partition size, regardless of the amount of disk space used, so it may take a considerable amount of time depending on the partition size, communication speed, and so on.
  - With **procedure (C)** whereby disk copy is performed while the operation is stopped (the group is deactivated), copy is performed by the amount equal to that of disk space used, depending on the file system, so the copy time may depend on the amount of disk space used. The operation (group activation) can be started after the completion of copy.
- 

6. On the server on which a new disk has been installed, enable the EXPRESSCLUSTER daemon, and restart the server.

---

**Note:**

- In case that the steps in “Disabling the EXPRESSCLUSTER daemon” in the *Installation and Configuration Guide* were executed before shutting down the server, enable the EXPRESSCLUSTER daemons at this time.  
On the server on which to enable the daemon, execute the command in the order below to enable the daemon.

```
chkconfig --add clusterpro_md
chkconfig --add clusterpro
chkconfig --add clusterpro_webmgr
chkconfig --add clusterpro_alertsync
```

---

7. Start the initial mirror construction (disk copy) by executing the command described below.

- ◆ (A) If the version is X3.1.8-1 or later when performing an operation on a server on which the mirror disk has not been replaced

The initial mirror construction (disk copy) is automatically started.

If you set **Execute the initial mirror construction** to Off, construction is not started automatically; use Mirror Disk Helper or either of the following commands to start it manually

**[For a mirror disk]**

```
clpmdctrl --force copy_source_server_name>
<mirror_disk_resource_name>
```

**[For a hybrid disk]**

```
clphdctrl --force copy_source_server_name>
<hybrid_disk_resource_name>
```

- ◆ **(B)** If the version is between X3.0.0-1 and X3.1.7-2, and if the operation is being performed on the server on which the mirror disk is not replaced  
(When performing copy in the state in which the group containing the mirror disk resource is active)

**[For a mirror disk]**

```
clpmdctrl --force -v <copy_source_server_name>
<mirror_disk_resource_name>
```

**[For a hybrid disk]**

```
clphdctrl --force -v <copy_source_server_name>
<hybrid_disk_resource_name>
```

- ◆ **(C)** If the operation is stopped, and the operation is to be started after the completion of disk copy  
(When performing copy when the group containing the mirror disk resource is deactivated)

**[For a mirror disk]**

```
clpmdctrl --force <copy_source_server_name>
<mirror_disk_resource_name>
```

**[For a hybrid disk]**

```
clphdctrl --force <copy_source_server_name>
<hybrid_disk_resource_name>
```

8. If the mirror disk monitor resource is suspended (A), use the WebManager or the `clpmonctrl` command to resume monitoring of the monitor resource.
9. If initial mirror construction is started while the operation is stopped (deactivated) (B), you can start the operation (activate the group) after the completion of the initial mirror construction (after the completion of disk copy).  
If mirror recovery is interrupted, start initial mirror construction without activating the group.

## In case of replacing a mirror disk constructed with a number of disks(RAID)

1. Stop the server of which the mirror disks are going to be replaced.

---

**Notes:**

- Before shutting down the server, it is recommended that the steps in “Disabling the EXPRESSCLUSTER daemon” in the *Installation and Configuration Guide* be executed.

On the server on which to disable the daemon, execute the command in the order below to disable the daemon.

```
chkconfig --del clusterpro_alertsync
chkconfig --del clusterpro_webmgr
chkconfig --del clusterpro
chkconfig --del clusterpro_md
```

- If a hybrid disk failure occurs, terminate all servers connected to the disk to be replaced.
- 

2. Install the new disks in the server.
3. Start up the server.
4. Reconstruct the RAID before OS startup.
5. Change the setting so that the EXPRESSCLUSTER services will not be executed at OS startup. In case of not having disabled the EXPRESSCLUSTER daemon in the step 1, startup the daemons in single user mode at OS startup, then startup the daemons on run level 3 after disabling the daemons.  
Back up data from the data partition as required.
6. If LUN is initialized, use the fdisk command to create cluster and data partitions on a new disk.

---

**Note:**

- If a hybrid disk failure occurs, terminate all servers connected to the disk to be replaced.
- 

7. Login as the root and initialize the cluster partition using one of the following methods.

◆ Method (1) Without using the dd command

For the mirror disk

```
clpmdinit --create force <mirror disk resource name>
```

For the hybrid disk

```
clphdinit --create force <hybrid disk resource name>
```

---

**Notes:**

- For the mirror disk, if “Execute initial mkfs” is set to “on” when the mirror disk resource is set up, mkfs is executed upon execution of this command to initialize the file system.  
However, mkfs may take a long time to complete in the case of a large-capacity disk. (once mkfs is executed, any data saved in the data partition will be erased. Back up the data in the data partition as required, therefore, before executing this command.)  
Mirror data is copied from the destination server by means of the entire recovery described later.

- If a hybrid disk failure occurs, terminate all servers connected to the disk to be replaced.
- 

◆ Method (2) Using the dd command

For the mirror disk

```
dd if=/dev/zero of=<cluster partition device name
(Example: /dev/sdb1)>

clpmdinit --create quick <mirror disk resource name>
```

For the hybrid disk

```
dd if=/dev/zero of=<cluster partition device name
(Example: /dev/sdb1)>

clphdinit --create quick <hybrid disk resource name>
```

---

**Notes:**

- When the `dd` command is executed, data in the partition specified by `of=` is initialized. Confirm whether the partition device name is correct, and then execute the `dd` command.
  - When the `dd` command is executed, the following message may appear. This does not, however, indicate an error.  

```
dd: writing to <CLUSTER partition device name>: No space left
on device
```
  - Mirror data is copied from the destination server by means of the entire recovery described later. Back up the data in the data partition as required, therefore, before executing this command.
  - If a hybrid disk failure occurs, terminate all servers connected to the disk to be replaced.
- 

**8.** Prevent initial mirror construction from being performed automatically.

- ◆ (A) For the version **X3.1.8-1 or later**, if, in the **state in which the operation is being performed** on the server on which a mirror disk **is not replaced** (state in which the group containing mirror disk resources is active), you want to concurrently perform disk copy (initial mirror construction), there is no particular need to make sure that initial mirror construction is not automatically performed.
  - ◆ (B) For a version between **X3.0.0-1 and X3.1.7-2**, if, in the **state in which the operation is being performed** on the server on which a mirror disk **is not replaced** (state in which the group containing mirror disk resources is active), you want to concurrently perform disk copy (initial mirror construction), use the WebManager or the `clpmonctrl` command to suspend the mirror disk monitor resource that is monitoring the mirror disk resources. (This prevents initial mirror construction, described later, from being performed automatically.)
  - ◆ (C) If the operation could be stopped until disk copy is completed (the group may be deactivated), deactivate the group containing the mirror disk resource.
- 

**Notes:**

- With **procedure (A)**, copy is performed by the amount equal to that of disk space used, depending on the type of file system, so the copy time may depend on the amount of disk space used.  
 Also, because the operation and copy are performed concurrently, the load may become high and copy may take time depending on the case.
- With **procedure (B)** whereby disk copy is performed while the operation is being performed (the group is kept active), copy is performed by the amount equal to the mirror disk partition size, regardless of the amount of disk space being used, so it may take a considerable amount of time depending on the partition size, communication speed, and so on.
- With **procedure (C)** whereby disk copy is performed while the operation is stopped (the group is deactivated), copy is performed by the amount equal to that of disk space

used, depending on the file system, so the copy time may depend on the amount of disk space used. The start of the operation (group activation) can be performed after the completion of copy.

---

9. On a server on which a disk has been replaced, enable the EXPRESSCLUSTER daemon, and then restart the server.
- 

**Note:**

- In the case that the steps in “Disabling the EXPRESSCLUSTER daemon” in the *Installation and Configuration Guide* were executed before shutting down the server, enable the EXPRESSCLUSTER daemons at this time.  
On the server on which to enable the daemon, execute the command in the order below to enable the daemon.

```
chkconfig --add clusterpro_md
chkconfig --add clusterpro
chkconfig --add clusterpro_webmgr
chkconfig --add clusterpro_alertsync
```

---

10. Use the following command to start the initial mirror construction (disk copy).

- ◆ (A) If the version is X3.1.8-1 or later when performing an operation on a server on which the mirror disk has not been replaced

The initial mirror construction (disk copy) is automatically started.

If you set **Execute the initial mirror construction** to Off, construction is not started automatically; use Mirror Disk Helper or either of the following commands to start it manually

**[For a mirror disk]**

```
clpmdctrl --force <copy_source_server_name>
<mirror_disk_resource_name>
```

**[For a hybrid disk]**

```
clphdctrl --force <copy_source_server_name>
<hybrid_disk_resource_name>
```

- ◆ (B) If the version is between X3.0.0-1 and X3.1.7-2, and if the operation is being performed on the server on which the mirror disk is not replaced  
(When copying in the state in which the group containing the mirror disk resource is active)

**[For a mirror disk]**

```
clpmdctrl --force -v <copy_source_server_name>
<mirror_disk_resource_name>
```

**[For a hybrid disk]**

```
clphdctrl --force -v <copy_source_server_name>
<hybrid_disk_resource_name>
```

- ◆ (C) If the operation is stopped, and is to be started after disk copy has been completed  
(When performing copy in the state in which the group containing the mirror disk resource is deactivated)

**[For a mirror disk]**

```
clpmdctrl --force <copy_source_server_name>
<mirror_disk_resource_name>
```

**[For a hybrid disk]**

```
clphdctrl --force <copy_source_server_name>
<hybrid_disk_resource_name>
```



11. If the mirror disk monitor resource is suspended (A), use the WebManager or the `clpmonctrl` command to resume monitoring of the monitor resource.
12. If initial mirror construction is started while the operation is stopped (deactivated) (B), you can start the operation (activate the group) after the completion of the initial mirror construction (after the completion of disk copy).  
If mirror recovery is interrupted, start the initial mirror construction without activating the group.

## In case of replacing mirror disks of both servers

---

### Note:

The data of mirror disks are lost after replacing the mirror disks of both servers. Restore the data from backup data or other media as necessary after replacing the disks.

---

1. Stop the both servers.

---

### Note:

- Before shutting down both servers, it is recommended that the steps in “Disabling the EXPRESSCLUSTER daemon” in the *Installation and Configuration Guide* are executed.

On the server on which to disable the daemon, execute the command in the order below to disable the daemon.

```
chkconfig --del clusterpro_alertsync
chkconfig --del clusterpro_webmgr
chkconfig --del clusterpro_
chkconfig --del clusterpro_md
```

---

2. Install the new disks in both servers.
3. Startup both servers. At this time, change the setting so that the EXPRESSCLUSTER services will not be executed. In case of not having disabled the EXPRESSCLUSTER daemon in the step 1, the daemons start up in single user mode at OS startup.
4. Construct the same partition as the original disk to the new disks of both servers by `fdisk` command.

---

### Note:

- To replace shared storage with the hybrid disk, create a partition and a file system with any server connected to that shared storage.
  - Initialize the cluster partition when using the disk used as an EXPRESSCLUSTER mirror disk or hybrid disk with data discarded. If required, initialize the file system of the data partition.
  - For more information on initializing the cluster partition (CLUSTER partition) and on creating a file system and whether to create one or not, see the related items ("Shared disk settings for hybrid disk resource", "Partition settings for hybrid disk resource", and "Partition settings for mirror disk resource") in "Settings after configuring hardware" in Chapter 1, "Determining a system configuration" in the *Installation and Configuration Guide*.
- 

5. Restart both servers.

---

### Note:

- In case that the steps in “Disabling the EXPRESSCLUSTER daemon” in the *Installation and Configuration Guide* were executed before shutting down the server, Enable the EXPRESSCLUSTER daemons at this time.

On the server on which to enable the daemon, execute the command in the order below to enable the daemon.

```
chkconfig --add clusterpro_md  
chkconfig --add clusterpro_  
chkconfig --add clusterpro_webmgr  
chkconfig --add clusterpro_alertsync
```

---

6. The initial mirror construction (entire mirror recovery) starts automatically by restarting. If you set **Execute the initial mirror construction** to Off, the normal state is assumed directly without automatically starting. Thus, in this case, use the Mirror Disk Helper of WebManager, `clpmdctrl`, or the `clphdctrl` command to manually start full mirror recovery.
7. After the completion of full mirror recovery, recover the data from a backup or the like after the completion of full mirror recovery.

## How to replace a server with a new one ~For a shared disk~

### When using online version Builder

Connect to the WebManager with a management IP address. If you do not have any management IP address, connect to it by using the IP address of a server that is not to be replaced.

1. Install the EXPRESSCLUSTER Server to the new server.  
For details, see Chapter 3, “Installing EXPRESSCLUSTER” in the Installation and Configuration Guide. The server on which you installed the EXPRESSCLUSTER Server should be restarted after the installation.
2. Start the online version Builder on the WebManager you connected to.
3. Upload the cluster configuration data on the Builder.
4. Start the services of a new server on the WebManager. For details on how to start services, see “Window of the WebManager Operating a cluster and cluster services on the WebManager” in Chapter 1, “Functions of the WebManager” in this guide.

## When using offline version Builder

Before you replace a server in the cluster with a new one, make sure to have the configuration data floppy disk that contains the information at the time a cluster was added (or if the configuration has been modified, the latest configuration data) with you.

If you do not have the above-mentioned floppy disk, you can back up the data with the `clpcfctrl` command. For details, see “Creating a cluster and backing up configuration data (`clpcfctrl` command)” in Chapter 3, “EXPRESSCLUSTER command reference” in this guide.

1. Install the EXPRESSCLUSTER Server to the new server.

For details, see Chapter 3, “Installing EXPRESSCLUSTER” in the *Installation and Configuration Guide*.

2. Hand-carry the floppy disk.

Insert the cluster configuration data floppy disk in the server where you installed the EXPRESSCLUSTER Server. The server on which you installed the EXPRESSCLUSTER Server should be restarted after the installation.

3. Distribute the configuration data in the floppy disk to servers.

Do either A or B depending on the floppy disk type you used to save data by the Builder.

- To use the floppy disk saved by the Builder on Linux, run the following command.

```
clpcfctrl --push -l
```

- To use the floppy disk (1.44-MB formatted) saved by the Builder on Windows, or on Linux for use on Windows, run the following command.

```
clpcfctrl --push -w
```

You see the following message if the data has successfully been distributed.

```
Command succeeded. (code:0)
```

For information on troubleshooting `clpcfctrl` problems, see “Creating a cluster and backing up configuration data (`clpcfctrl` command)” in Chapter 3, “EXPRESSCLUSTER command reference” in this guide.

4. Remove the cluster configuration data floppy disk from the drive. Restart the server on which the EXPRESSCLUSTER Server was installed.

## How to replace a server with a new one ~For a mirror disk~

### Replacing a server and its mirror disk (when using online version Builder)

Connect to the WebManager with a management IP address. If you do not have any management IP address, connect to it by using the IP address of a server that is not to be replaced.

1. Replace the failed server machine and the disk. Set the same IP address and host name in the new server as the old server.

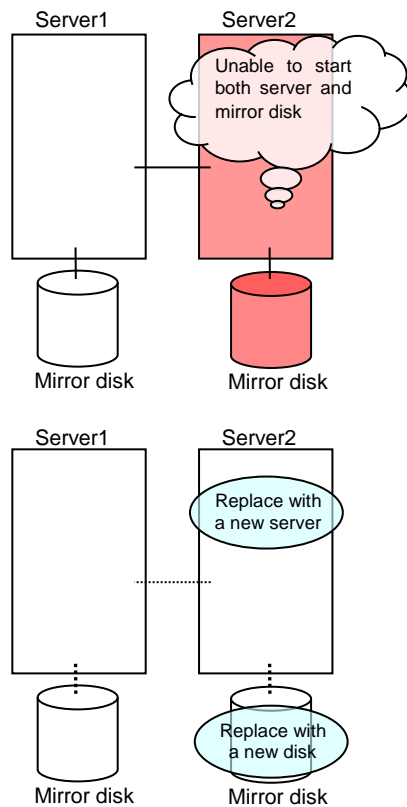

2. Create partitions in the new disk by executing the fdisk command.

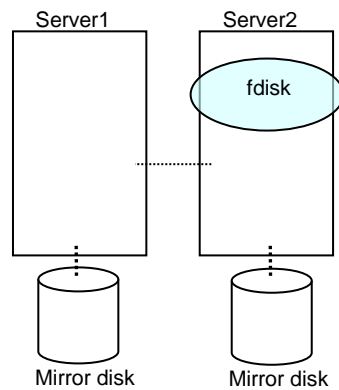

Install the EXPRESSCLUSTER Server on the new server. For details, see Chapter 3, “Installing EXPRESSCLUSTER” in the Installation and Configuration Guide. The server on which you installed the EXPRESSCLUSTER Server should be restarted after the installation.

3. When using the disk that was used as a mirror disk before, initialize the cluster partition.
4. Start the online version Builder on the WebManager you connected to.
5. Upload the cluster configuration data on the online version Builder. When uploading the data completes, restart the replaced server.

- After the server is restarted, the cluster partitions in the new disk will be initialized and a file system will be created in the data partition.

The mirror recovery is executed if the initial mirror construction is set. If not, you have to manually recover mirroring.

For information on recovery of disk mirroring, refer to “Recovering mirror with a command” on page 1393 and “Recovering mirror using the WebManager” on page 1402.

In mirror recovery, the data is fully copied.

Confirm that mirroring is successfully recovered by using the WebManager or by running the following command. For details, see “Mirror-related commands” in Chapter 3, “EXPRESSCLUSTER command reference” in this guide.

```
clpmdstat --mirror < mirror_disk_resource_name (Example: md1) >
```

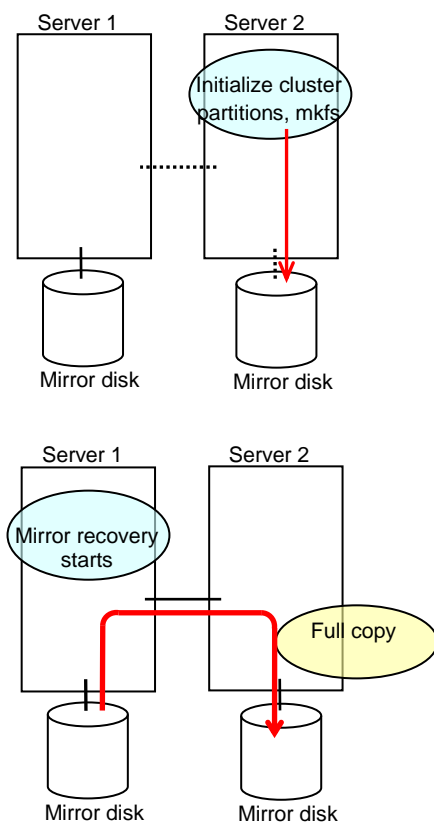

## Replacing a server and its mirror disk (when using offline version Builder)

Before you replace a server in the cluster with a new one, make sure to have the configuration data floppy disk that contains the information at the time server was added to the cluster (or if the configuration has been modified, the latest configuration data) with you.

If you do not have the above-mentioned floppy disk at hand, you can back up the data with the `clpcfctrl` command. For details, see “Creating a cluster and backing up configuration data (`clpcfctrl` command)” in Chapter 3, “EXPRESSCLUSTER command reference” in this guide.

---

### Related Information:

For information on troubleshooting `clpcfctrl` problems, see “Creating a cluster and backing up configuration data (`clpcfctrl` command)” in Chapter 3, “EXPRESSCLUSTER command reference” in this guide.

For details on how to stop and start daemons, see “Suspending EXPRESSCLUSTER” in Chapter 9, “Preparing to operate a cluster system” in the *Installation and Configuration Guide*.

---

1. Replace the failed server machine and the disk. Set the same IP address and host name in the new server as the old server.

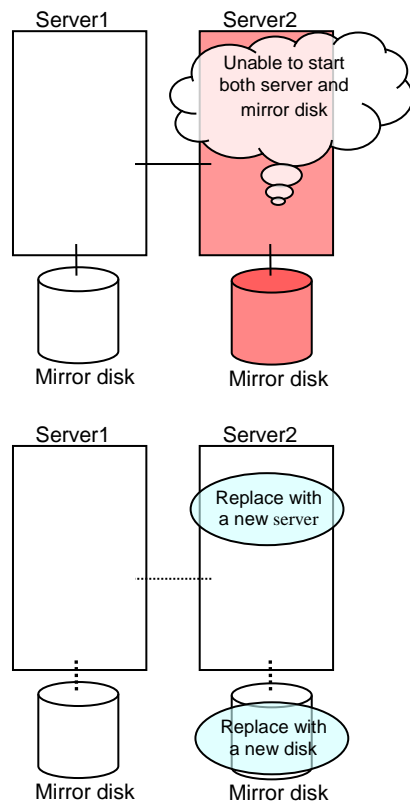



2. Create partitions in the new disk by executing the fdisk command.

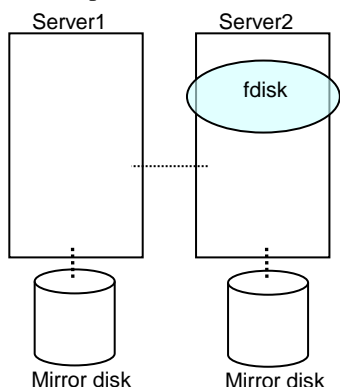

3. Install the EXPRESSCLUSTER Server on the new server. For details, see Chapter 3, “Installing EXPRESSCLUSTER” in the *Installation and Configuration Guide*.
4. Hand-carry the floppy disk. Insert the cluster configuration data floppy disk in the server where you installed the EXPRESSCLUSTER Server. The server on which you installed the EXPRESSCLUSTER Server should be restarted after the installation.
5. Distribute the configuration data in the floppy disk to servers. Do either A or B depending on the floppy disk type you used to save data by the Builder.

- To use the floppy disk saved by the Builder on Linux, run the following command.

```
clpcfctrl --push -l
```

- To use the floppy disk (1.44-MB formatted) saved by the Builder on Windows, or on Linux for use on Windows, run the following command.

```
clpcfctrl --push -w
```

You see the following message if the data has successfully been distributed.

```
Command succeeded. (code:0)
```

For information on troubleshooting clpcfctrl problems, see “Creating a cluster and backing up configuration data (clpcfctrl command)” in Chapter 3, “EXPRESSCLUSTER command reference” in this guide.

6. When using the disk that was used as a mirror disk before, initialize the cluster partition.
7. Remove the cluster configuration data floppy disk from the floppy disk drive. Restart the server that the EXPRESSCLUSTER Server was installed.

8. After the server is restarted, the cluster partitions in the new disk will be initialized and a file system will be created in the data partition.

The mirror recovery is executed if the initial mirror construction is set. If not, you have to manually recover mirroring.

For information on recovery of disk mirroring, refer to “Recovering mirror with a command” on page 1393 and “Recovering mirror using the WebManager” on page 1402.

In mirror recovery, the data is fully copied.

Confirm that mirroring is successfully recovered by using the WebManager or by running the following command. For details, see “Mirror-related commands” in Chapter 3, “EXPRESSCLUSTER command reference” in this guide.

```
clpmdstat --mirror < mirror_disk_resource_name (Example: md1) >
```

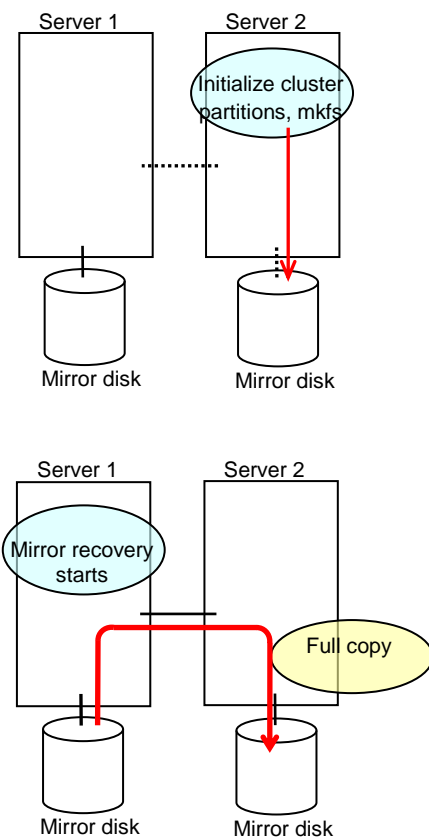

## Using the mirror disk of the failed server (when using online version Builder)

Connect to the WebManager with a management IP address. If you do not have any management IP address, connect to it by using the IP address of a server that is not to be replaced.

1. Replace the failed server machine but continue using the mirror disk of the failed server. Set the same IP address and host name in the new server as before.

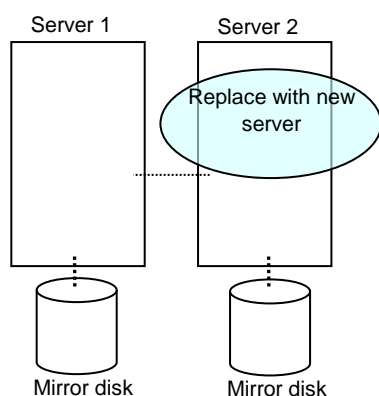
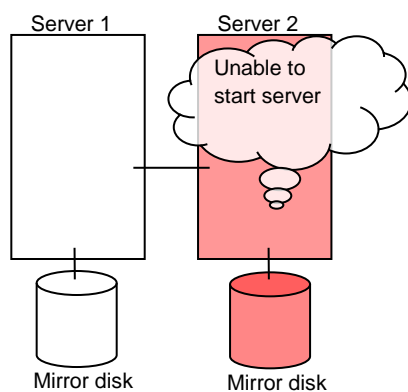

Install the EXPRESSCLUSTER Server on the new server. For details, see Chapter 3, “Installing EXPRESSCLUSTER” in the *Installation and Configuration Guide*. Restart the server on which the EXPRESSCLUSTER Server was installed.

2. Start the online version Builder on the WebManager you connected to.
3. Upload the cluster configuration data on the online version Builder. When uploading the data completes, restart the replaced server.

4. If there is no difference in mirror disks, you can immediately start the operation after restarting the server. On the other hand, if there is any difference in mirror disks, you have to recover the mirroring data after restarting the server. The disk mirroring is automatically recovered when auto-mirror recovery is enabled. If not, you have to manually recover disk mirroring. For information on recovery of disk mirroring, refer to “Recovering mirror with a command” on page 1393 and “Recovering mirror using the WebManager” on page 1402.

Confirm that mirroring is successfully recovered by using the WebManager or by running the following command. For details, see “Mirror-related commands” in Chapter 3, “EXPRESSCLUSTER command reference” in this guide.

```
clpmdstat --mirror < mirror_disk_resource_name (Example: md1)>
```

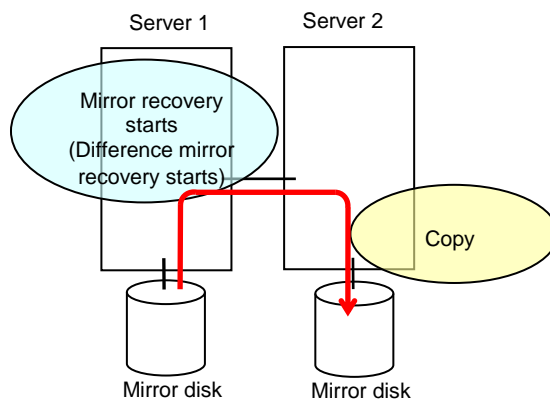

## Using the mirror disk of the failed server (when using offline version Builder)

Before you replace a server in the cluster with a new one, make sure to have the configuration data floppy disk that contains the information at the time server was added to the cluster (or if the configuration has been modified, the latest configuration data) with you.

If you do not have the above-mentioned floppy disk at hand, you can back up the data with the `clpcfctrl` command. For details, see “Creating a cluster and backing up configuration data (`clpcfctrl` command)” in Chapter 3, “EXPRESSCLUSTER command reference” in this guide.

---

### Related Information:

For information on troubleshooting `clpcfctrl` problems, see “Creating a cluster and backing up configuration data (`clpcfctrl` command)” in Chapter 3, “EXPRESSCLUSTER command reference” in this guide.

For details on how to stop and start daemons, see “Suspending EXPRESSCLUSTER” in Chapter 9, “Preparing to operate a cluster system” in the *Installation and Configuration Guide*.

---

1. Replace the failed server machine but continue using the mirror disk of the failed server. Set the same IP address and host name in the new server as before.

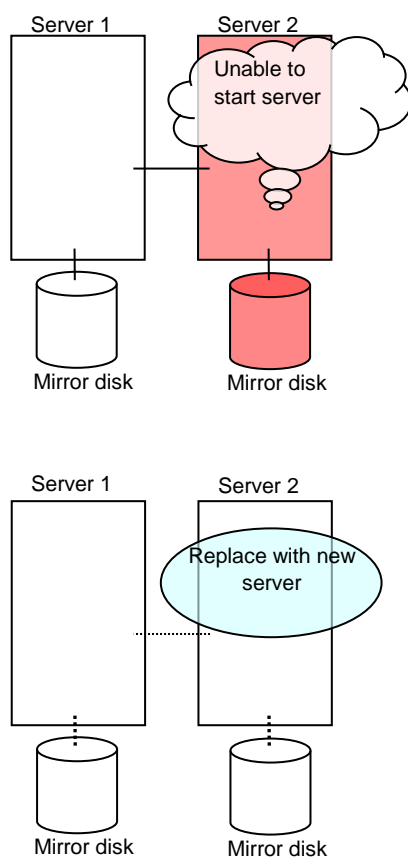

2. Install the EXPRESSCLUSTER Server on the new server. For details, see Chapter 3, “Installing EXPRESSCLUSTER” in the *Installation and Configuration Guide*.

3. Hand-carry the floppy disk. Insert the cluster configuration data floppy disk in the server where you installed the EXPRESSCLUSTER Server. The server on which you installed the EXPRESSCLUSTER Server should be restarted after the upload.
4. Distribute the configuration data in the floppy disk to servers. Do either A or B depending on the floppy disk type you used to save data by the Builder.

- To use the floppy disk saved by the Builder on Linux, run the following command.

```
clpcfctrl --push -l
```

- To use the floppy disk (1.44-MB formatted) saved by the Builder on Windows, or on Linux for use on Windows, run the following command.

```
clpcfctrl --push -w
```

You see the following message if the data has successfully been distributed.

```
Command succeeded. (code:0)
```

For information on troubleshooting clpcfctrl problems, see “Creating a cluster and backing up configuration data (clpcfctrl command)” in Chapter 3, “EXPRESSCLUSTER command reference” in this guide.

5. Remove the cluster configuration data floppy disk from the floppy disk drive. Restart the server on which the EXPRESSCLUSTER Server was installed.
6. If there is no difference in mirror disks, you can immediately start the operation after restarting the server. On the other hand, if there is any difference in mirror disks, you have to recover the mirroring data after restarting the server. The disk mirroring is automatically recovered when auto-mirror recovery is enabled. If not, you have to manually recover disk mirroring. For information on recovery of disk mirroring, refer to “Recovering mirror with a command” on page 1393 and “Recovering mirror using the WebManager” on page 1402.

Confirm that mirroring is successfully recovered by using the WebManager or by running the following command. For details, see “Mirror-related commands” in Chapter 3, “EXPRESSCLUSTER command reference” in this guide.

```
clpmdstat --mirror < mirror_disk_resource_name (Example: md1) >
```

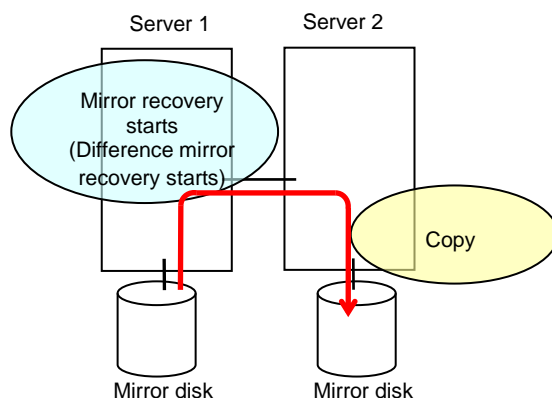

## How to replace a server with a new one ~For a hybrid disk~

### Replacing a server and its non-shared hybrid disk (when using online version Builder)

Connect to the WebManager with a management IP address. If you do not have any management IP address, connect to it by using the IP address of a server that is not to be replaced.

1. Replace the failed server machine and the disk. Set the same IP address and host name in the new server as the old server.

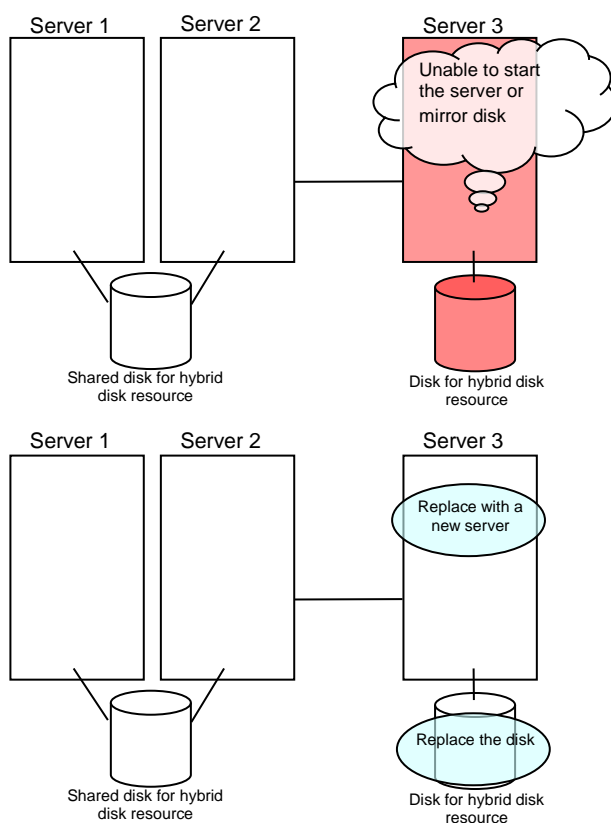

2. Create partitions in the new disk by executing the fdisk command.

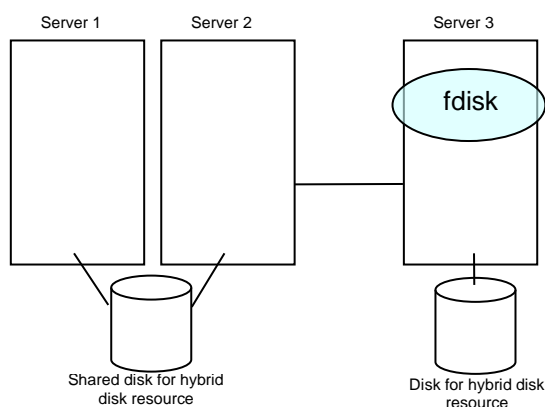

3. Install the EXPRESSCLUSTER Server on the new server. For details, see Chapter 3, “Installing EXPRESSCLUSTER” in the Installation and Configuration Guide. The server on which you installed the EXPRESSCLUSTER Server should be restarted after the installation.
4. Start the online version Builder on the WebManager you connected to.
5. Upload the cluster configuration data on the online version Builder.
6. Execute the `clphdinit` command in the replaced server.

```
# clphdinit --create force <Hybrid disk resource name (Example: hd1)>
```

7. Restart the replaced server.
8. After the server is restarted, the mirror recovery is executed if the initial mirror construction is set. If not, you have to manually recover mirroring. For information on recovery of disk mirroring, refer to “Recovering mirror with a command” on page 1393 and “Recovering mirror using the WebManager” on page 1402.

In mirror recovery, the data is fully copied.

Confirm that mirroring is successfully recovered by using the WebManager or by running the following command. For details, see “Hybrid-disk-related commands” in Chapter 3, “EXPRESSCLUSTER command reference” in this guide.

```
clphdstat --mirror < hybrid_disk_resource_name (Example: hd1)>
```

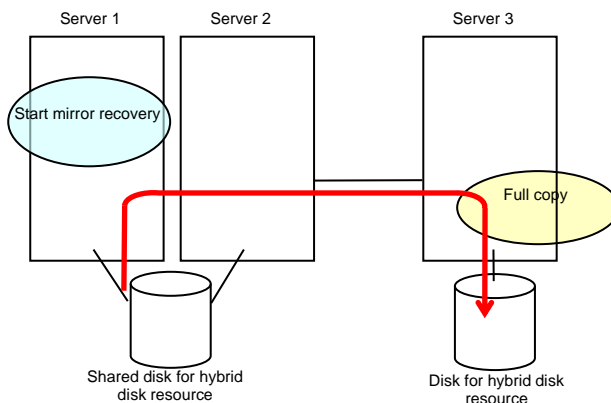



## Replacing a server and a hybrid disk of the shared disk (when using online version Builder)

Connect to the WebManager with a management IP address. If you do not have any management IP address, connect to it by using the IP address of a server that is not to be replaced.

1. Run the `chkconfig` command in the following order and configure the settings not to start the EXPRESSCLUSTER services in the server that was connected to the failing server via the shared disk. In SUSE Linux, run the command with the `--force` option.

```
# chkconfig --del clusterpro
```

```
# chkconfig --del clusterpro_md
```

2. Shut down the server that was connected to the failing server via the shared disk by running the OS shutdown command etc.  
If you want to keep the operation during replacement, move the group to server 3.

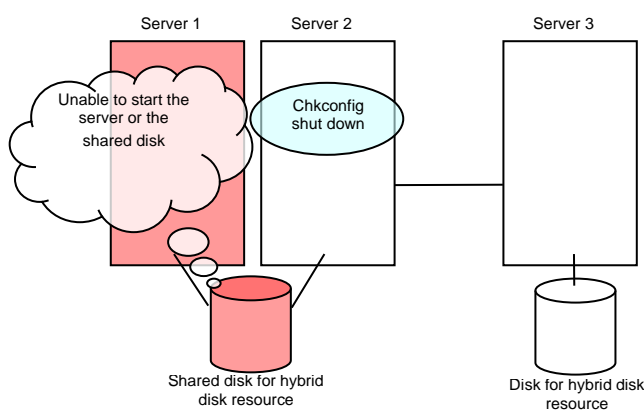

3. Replace the failed server machine and the shared disk. Set the same IP address and host name in the new server as the old server.

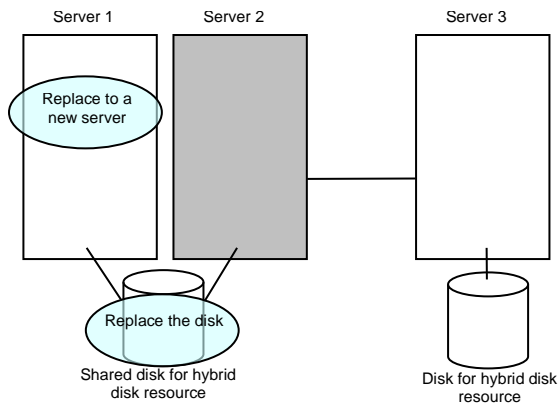
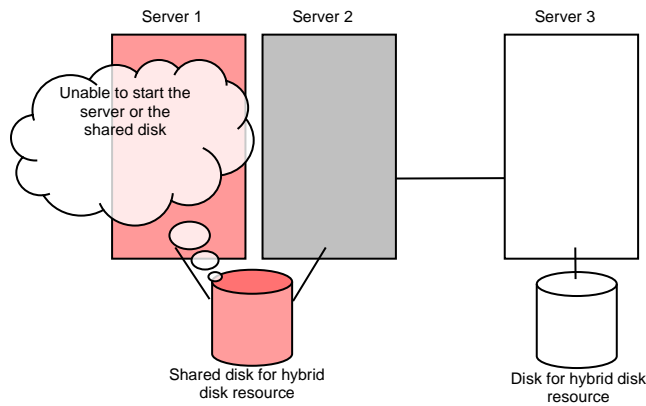

4. Create disk partitions from the replaced server by executing the fdisk command.

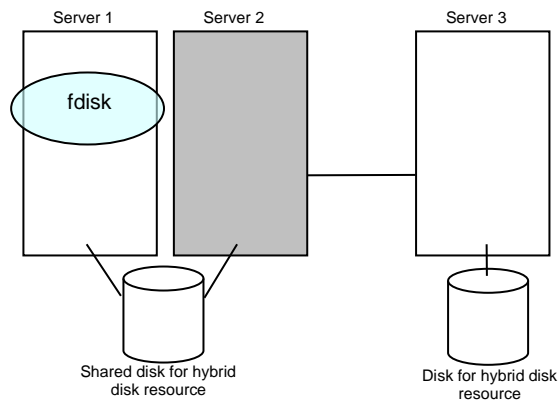

5. Install the EXPRESSCLUSTER Server on the new server. For details, see Chapter 3, “Installing EXPRESSCLUSTER” in the *Installation and Configuration Guide*. The server on which you installed the EXPRESSCLUSTER Server should be restarted after the installation. Start the server that was connected to the failing server via the shared disk.

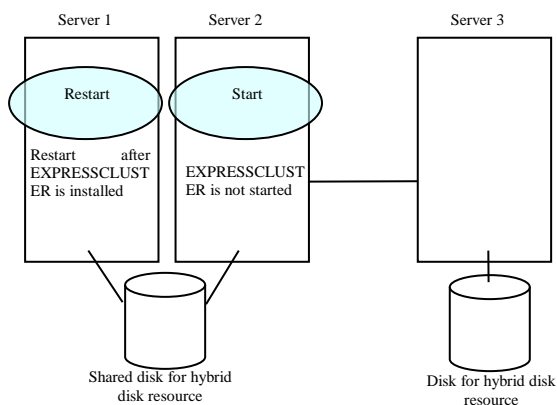

6. Start the online version Builder on the WebManager you connected to.
7. Upload the cluster configuration data from the online version Builder.
8. On the replaced server, run the clphdinit command.

```
# clphdinit --create force <hybrid disk resource name (example: hd1)>
```

9. Configure the settings to start the EXPRESSCLUSTER services in the server that was connected to the failing server via the shared disk by running the chkconfig command.

```
# chkconfig --add clusterpro_md
# chkconfig --add clusterpro
```

10. Restart the replaced server as well as the server that was connected to the failing server via the shared disk.

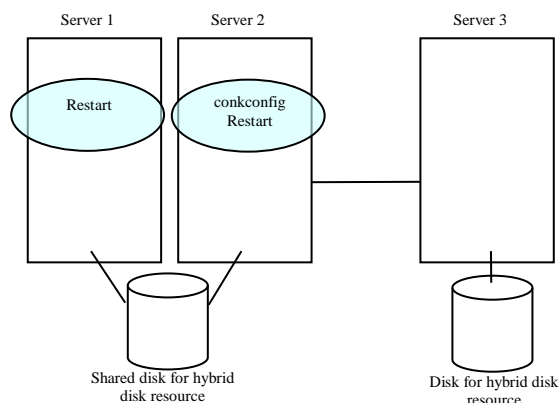

11. After the server is restarted, the mirror recovery is executed if the initial mirror construction is set. If not, you have to manually recover mirroring  
For information on recovery of disk mirroring, refer to “Recovering mirror with a command” on page 1393 and “Recovering mirror using the WebManager” on page 1402.

The destination server of disk mirroring is the current server of the server group to which the shared disk is connected (The figure below shows an example where the server 1 is the current server).

In mirror recovery, the data is fully copied.

Check that mirror recovery has completed by running the following command, or by using WebManager. For details, see “Hybrid-disk-related commands” in Chapter 3, “EXPRESSCLUSTER command reference” in this guide.

**clphdstat --mirror <hybrid disk resource name (example: hd1)>**

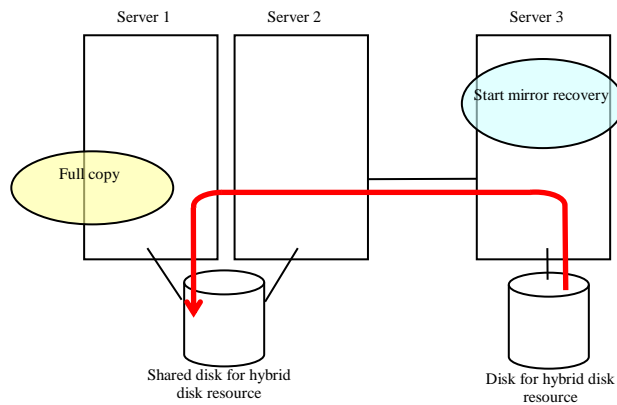

## Using the disk of the failed server (when using online version Builder)

Connect to the WebManager with a management IP address. If you do not have any management IP address, connect to it by using the IP address of a server that is not to be replaced.

1. Replace the failed server machine but continue using the disk of the failed server. Set the same IP address and host name in the new server as before.

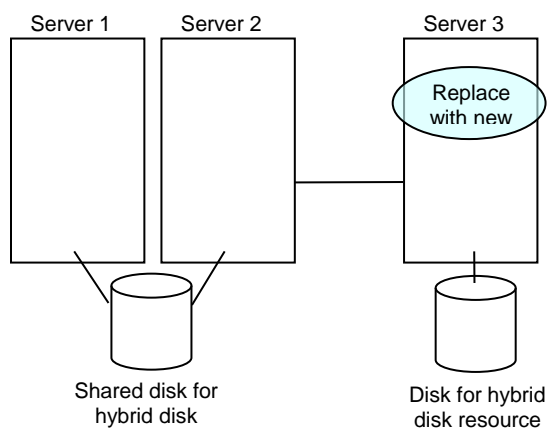
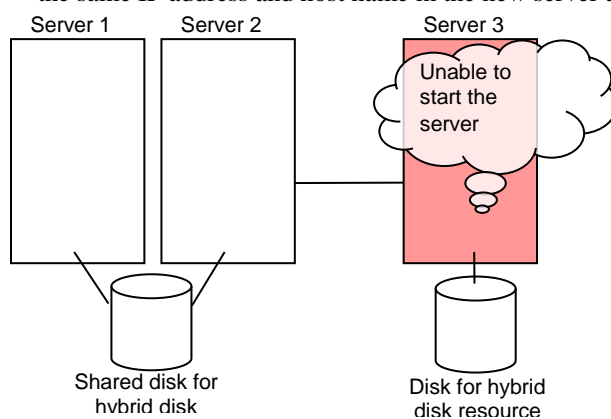

2. Install the EXPRESSCLUSTER Server on the new server. For details, see Chapter 3, "Installing EXPRESSCLUSTER" in the Installation and Configuration Guide. Restart the server on which the EXPRESSCLUSTER Server was installed.

3. Start the online version Builder on the WebManager you connected to.
4. Upload the cluster configuration data on the online version Builder. When uploading the data completes, restart the replaced server.
5. If there is no difference in mirror disks, you can immediately start the operation after restarting the server. On the other hand, if there is any difference in mirror disks, you have to recover the mirroring data after restarting the server.  
The disk mirroring is automatically recovered when auto-mirror recovery is enabled. If not, you have to manually recover disk mirroring. For information on recovery of disk mirroring, refer to “Recovering mirror with a command” on page 1393 and “Recovering mirror using the WebManager” on page 1402.

Confirm that mirroring is successfully recovered by using the WebManager or by running the following command. For details, see “Hybrid-disk-related commands” in Chapter 3, “EXPRESSCLUSTER command reference” in this guide.

```
clpmdstat --mirror <hybrid_disk_resource_name (Example: hd1)>
```

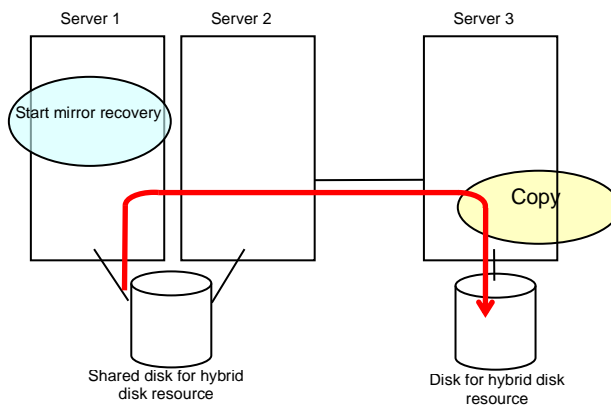

## Replacing a server to which the shared disk is connected (when using online version Builder)

Connect to the WebManager with a management IP address. If you do not have any management IP address, connect to it by using the IP address of a server that is not to be replaced.

1. Replace the failed server machine and the shared disk. Set the same IP address and host name in the new server as the old server.

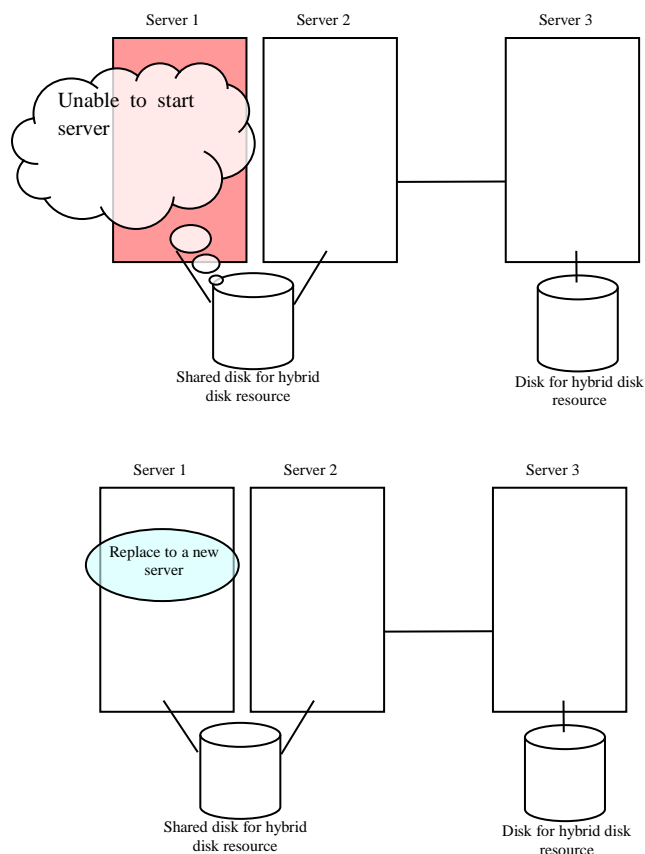

2. Install the EXPRESSCLUSTER Server on the new server. For details, see Chapter 3, “Installing EXPRESSCLUSTER” in the *Installation and Configuration Guide*. Restart the server on which the EXPRESSCLUSTER Server was installed
3. Start the online version Builder on the WebManager you connected to.
4. Upload the cluster configuration data on the online version Builder. When uploading the data completes, restart the replaced server.

## Wait time for synchronized cluster startup

Even all servers in a cluster are powered on simultaneously, it does not always mean that EXPRESSCLUSTER will start up simultaneously on all servers. EXPRESSCLUSTER may not start up simultaneously after rebooting the cluster following shutdown. Because of this, with EXPRESSCLUSTER, if one server is started, it waits for other servers in the cluster to start.

By default, 5 minutes is set to the startup synchronization time. To change the default value, click **Cluster Properties** in the Builder, click **Timeout** tab, and select **Synchronize Wait Time**.

For more information, see “Cluster properties Timeout tab” in Chapter 2, “Functions of the Builder” in this guide.



## Changing disk resources file system

### How to change disk resources file system (when using online version Builder)

Connect to the WebManager with a management IP address. If you do not have any management IP address, connect to it by using the actual IP address of any server.

To change the disk resource file system, follow the steps below:

1. From the **Service** menu on the WebManager, click **Stop Cluster**.
2. Run the following command.

For example, when the disk resources partition device is /dev/sdb5:

```
# ciproset -w -d /dev/sdb5
```

This makes disk partition of disk resources readable/writable regardless of the EXPRESSCLUSTER behavior.

---

**Note:**

Do not use this command for any other purposes.

If you use this command when the EXPRESSCLUSTER daemon is active, the file system may be corrupted.

---

3. Create the file system in the partition device.
4. Run the following command to set the disk resources partition to ReadOnly.  
For example, when the disk resources partition device is /dev/sdb5:  

```
# ciproset -o -d /dev/sdb5
```
5. Start the online version Builder on the WebManager you connected to.
6. Change the configuration data of disk resource file system by using the Builder.
7. Upload the cluster configuration data on the Builder.
8. From the **Service** menu on the WebManager, click **Start Cluster**.

The settings reflecting the changes become effective.

## How to change disk resources file system (when using offline version Builder)

To change the disk resource file system, follow the steps below:

1. Stop the EXPRESSCLUSTER daemon.

```
# clpcl -t -a
```

2. Back up the cluster configuration data in a floppy disk. Do either A or B depending on the floppy disk type you used to save the data by Builder:

- To back up data in a floppy disk for the Builder working on Linux Web browser, run the following command:

```
# clpcfctrl --pull -l
```

- To back up data in a floppy disk for the Builder working on Windows Web browser, run the following command:

```
# clpcfctrl --pull -w
```

3. Run the following command.

For example, when the disk resources partition device is /dev/sdb5:

```
# clproset -w -d /dev/sdb5
```

This makes disk partition of disk resources readable/writable regardless of the EXPRESSCLUSTER behavior.

---

**Note:**

Do not use this command for any other purposes.

If you use this command when the EXPRESSCLUSTER daemon is active, the file system may be corrupted.

---

4. Create the file system in the partition device.
5. Run the following command to set the disk resources partition to ReadOnly.

For example, when the disk resources partition device is /dev/sdb5:

```
# clproset -o -d /dev/sdb5
```

6. Change the configuration data of disk resource file system by using the Builder.
7. Distribute the configuration data in the floppy disk to the server. Do either A or B depending on the floppy disk type you used to save the data by the Builder:

- If you use the floppy disk created by the Builder for Linux, run the following command:

```
# clpcfctrl --push -l
```

- If you use the floppy disk (1.44-MB formatted) created by the Builder for Windows, run the following command:

```
# clpcfctrl --push -w
```

8. Remove the floppy disk from the floppy disk drive.

The settings reflecting the changes become effective at next EXPRESSCLUSTER daemon startup.

## Changing offset or size of a partition on mirror disk resource

Follow the procedure below when changing the offset (location) or size of the data partition or cluster partition configured on a mirror disk resource after the operation of a cluster is started.

**Note:**

Be sure to follow the steps below to change them. Mirror disk resources may not function properly if you change the partition specified as a data partition or cluster partition only by fdisk.

### When not changing a device name of a partition on mirror disk resource

1. Check the name of a mirror disk resource whose size you want to change by the clpstat command or by the WebManager.
2. On the server where a group with a mirror disk resource whose size you want to change is activated, back up the data in a partition to a device such as tape. Note that backup commands that access a partition device directly are not supported. This step is not required if there is no problem to discard the data on a mirror disk resource.

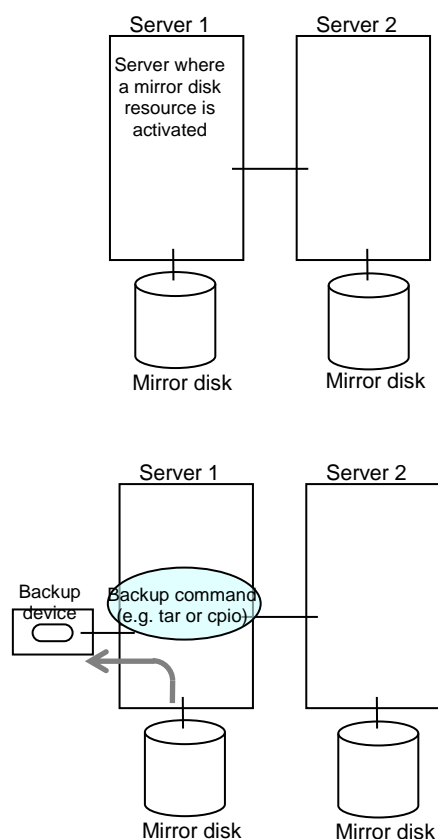

3. Run the `chkconfig` command in the following order not to start the EXPRESSCLUSTER services. In SUSE Linux, run the command with the `--force` option.

```
# chkconfig --del clusterpro
```

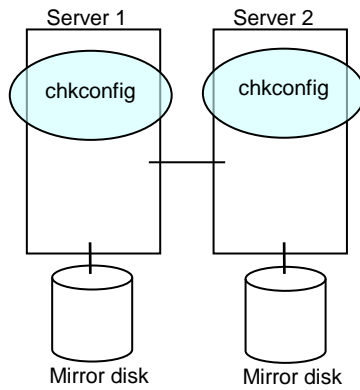

```
# chkconfig --del clusterpro_md
```

4. Shut down a cluster, and then restart the OS.  
To shut down a cluster, run the `clpstdn` command on either of a server, or execute a cluster shutdown on the WebManager.

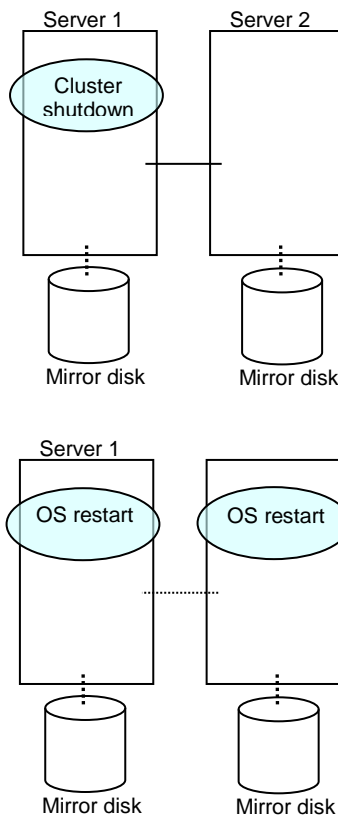

5. On both servers, run the fdisk command to change the offset or size of a partition.

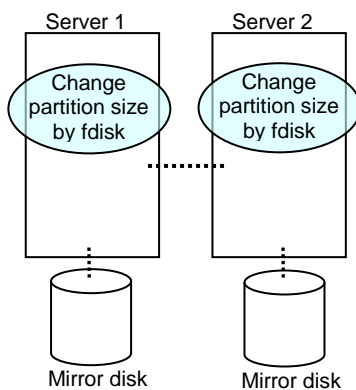

6. Run the following command on both servers.

```
# clpmdinit --create force <Mirror_disk_resource_name>
```

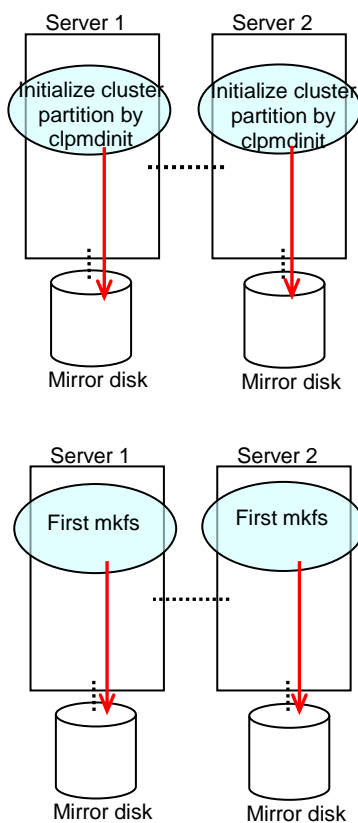

7. Run the `chkconfig` command in the following order to start the EXPRESSCLUSTER services.

```
# chkconfig --add clusterpro_md  
# chkconfig --add clusterpro
```

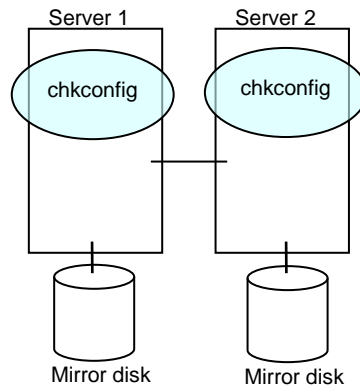

8. Run the `reboot` command to restart both servers. The servers are started as a cluster.
9. After a cluster is started, the same process as the initial mirror construction at cluster creation is performed. Run the following command or use the WebManager to check if the initial mirror construction is completed.

```
# clpmdstat --mirror <Mirror_disk_resource_name>
```

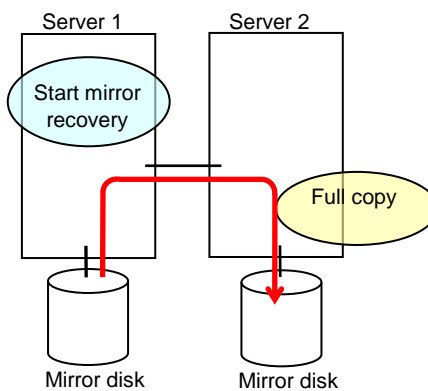

10. When the initial mirror construction is completed and a failover group starts, a mirror disk resource becomes active.

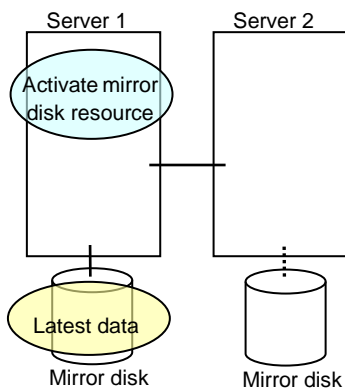

11. On the server where a group with a mirror partition whose size you changed is activated, restore the data you backed up. Note that backup commands that access a partition device directly are not supported. This step is not required if there is no problem to discard the data on a mirror disk resource.

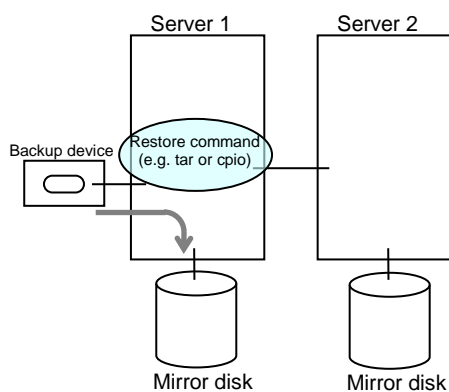

## When changing a device name of a partition on mirror disk resource

1. Check the name of a mirror disk resource whose size you want to change by the `clpstat` command or by the WebManager.
2. On the server where a group with a mirror disk resource whose size you want to change is activated, back up the data in a partition to a device such as tape. Note that backup commands that access a partition device directly are not supported. This step is not required if destroying the data on a mirror disk resource does not cause any problem.

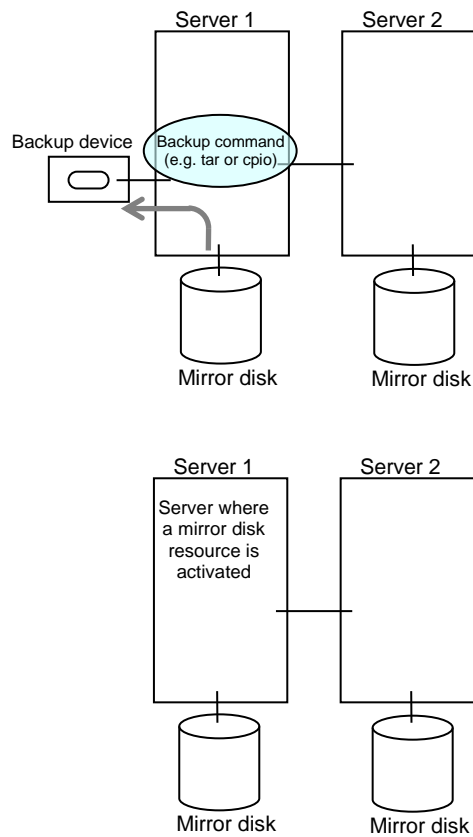



- Run the `chkconfig` command in the following order not to start the EXPRESSCLUSTER services. In SUSE Linux, execute the command with the `--force` option.

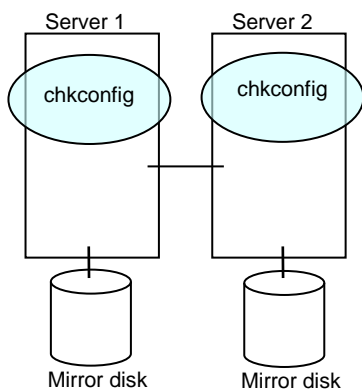

```
# chkconfig --del clusterpro
# chkconfig --del clusterpro_md
```

- Shut down a cluster, and then restart the OS. To shut down a cluster, run the `clpstdn` command on either of a server, or execute a cluster shutdown on the WebManager.

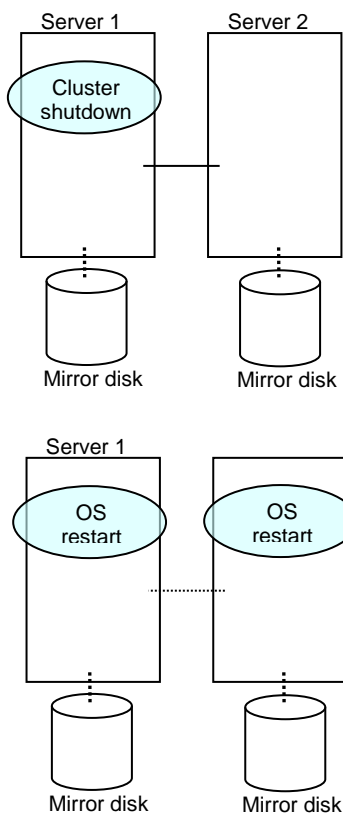

- On both servers, run the fdisk command to change the offset or size of a partition.

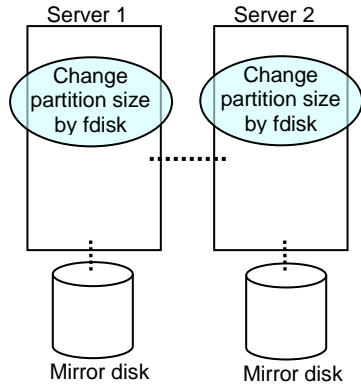

- Change and upload the cluster configuration data. Change a mirror disk resource as described in “Modifying the cluster configuration data by using the EXPRESSCLUSTER Builder (online version)” or “Modifying the cluster configuration data by using the EXPRESSCLUSTER Builder (offline version)” in Chapter 7, “Modifying the cluster configuration data” in the *Installation and Configuration Guide*. See the corresponding steps as those are different depending on using the online or offline version Builder.
- Run the following command on the both servers.

```
# clpmdinit --create force <Mirror_disk_resource_name>
```

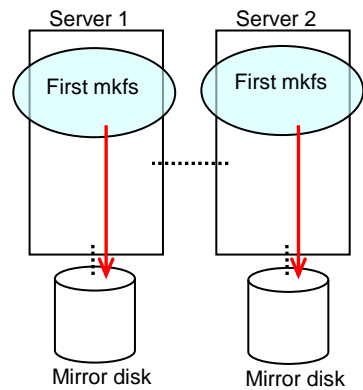
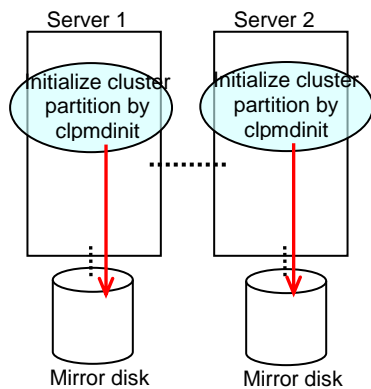

- Run the chkconfig command in the following order to start the EXPRESSCLUSTER services.

```
# chkconfig --add clusterpro_md
# chkconfig --add clusterpro
```

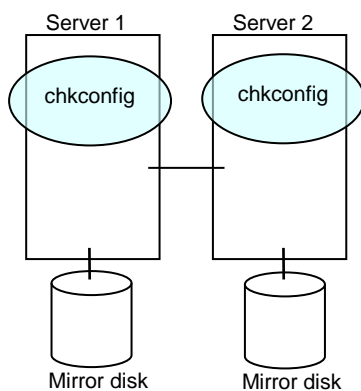

9. Run the reboot command to restart both servers. The servers are started as a cluster.
10. After a cluster is started, the same process as the initial mirror construction at cluster creation is performed. Run the following command or use the WebManager to check if the initial mirror construction is completed.

```
# clpmdstat --mirror <Mirror_disk_resource_name>
```

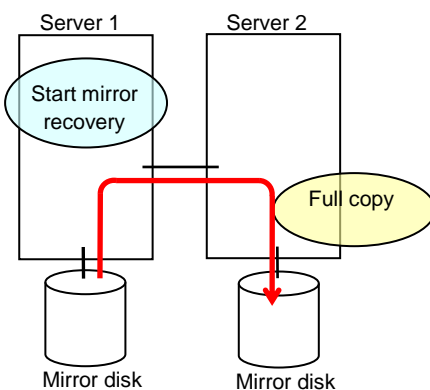

11. When the initial mirror construction is completed and a failover group starts, a mirror disk resource becomes active.

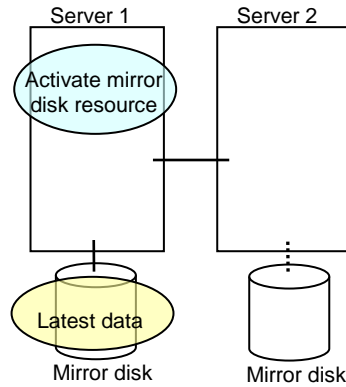

12. On the server where a group with a mirror partition whose size you changed is activated, restore the data you backed up. Note that backup commands that access a partition device directly are not supported. This step is not required if there is no problem to discard the data on a mirror disk resource.

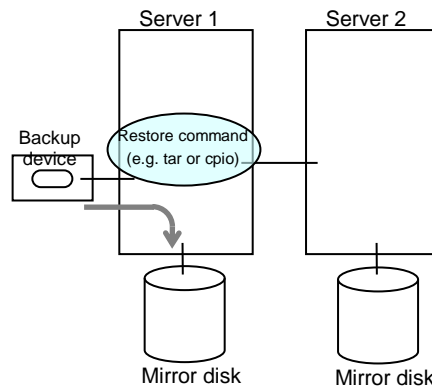

## Changing offset or size of a partition on hybrid disk resource

Follow the procedure below when changing the offset (location) or size of the data partition or cluster partition configured on a hybrid disk resource after the operation of a cluster is started.

**Note:**

Be sure to follow the steps below to change them. Hybrid disk resources may not function properly if you change the partition specified as a data partition or cluster partition only by fdisk.

### When not changing a device name of a partition on hybrid disk resource

1. Check the name of a hybrid disk resource whose size you want to change by the clpstat command or by the WebManager.
2. On the server where a group with the hybrid disk resource whose size you want to change is activated, back up the data in a partition to a device such as tape. Note that backup commands that access a partition device directly are not supported. This step is not required if there is no problem to discard the data on the hybrid disk resource.

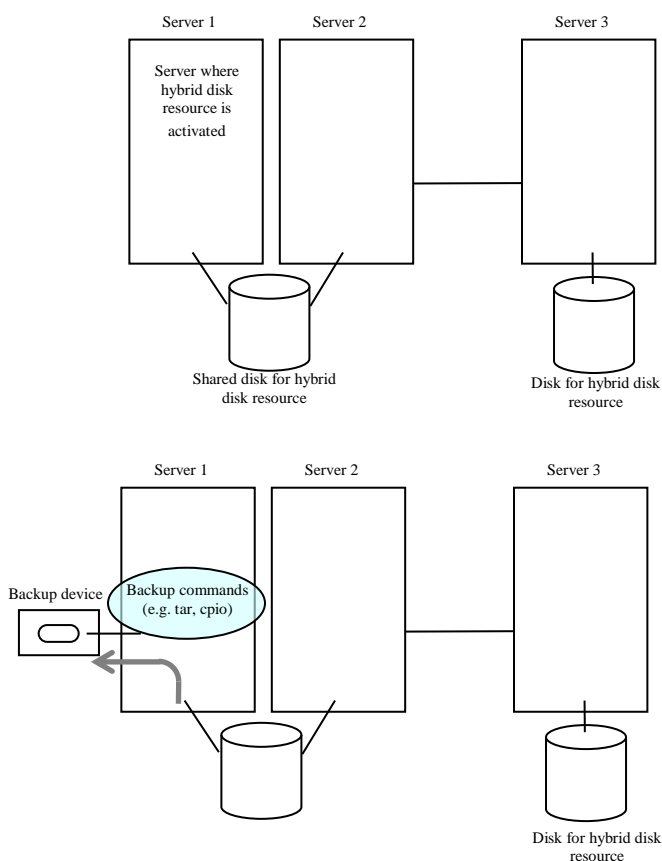

- Run the `chkconfig` command in the following order not to start the EXPRESSCLUSTER services. In SUSE Linux, run the command with the `--force` option.

```
# chkconfig --del clusterpro
# chkconfig --del clusterpro_md
```

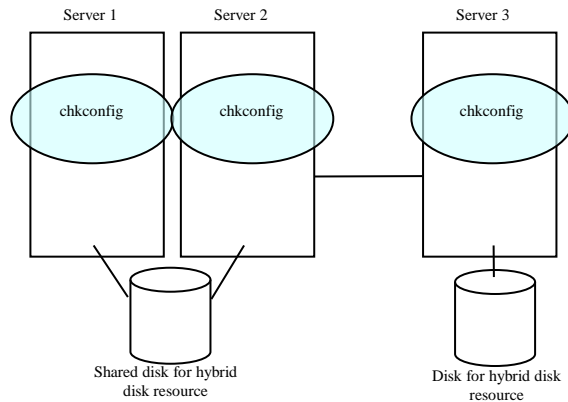

- Shut down a cluster, and then restart the OS. To shut down a cluster, run the `clpstdn` command on either of a server, or execute a cluster shutdown on the WebManager.

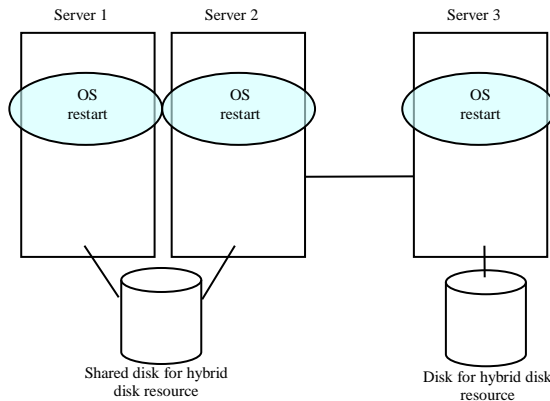
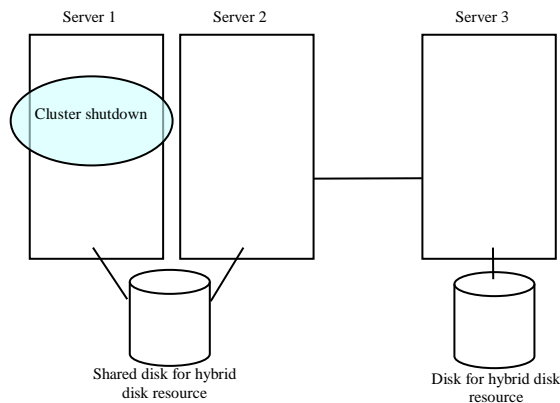

5. Run the fdisk command on a server to change the offset or size of a partition. When servers are connected to the shared disk, run the fdisk from either of the servers for the change.

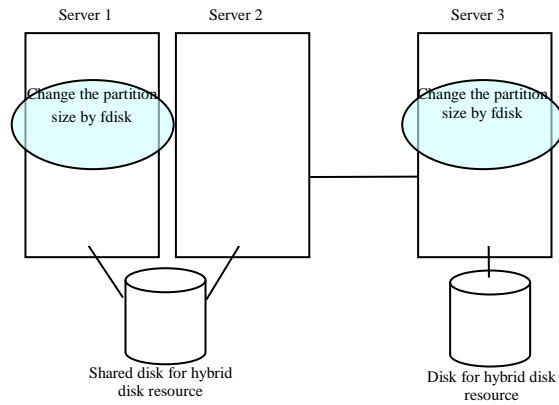

6. Run the following command on a server. When servers are connected to the shared disk, run the command on the server where the command in previous step was executed.  
**# clpmdinit --create force <Mirror\_disk\_resource\_name>**

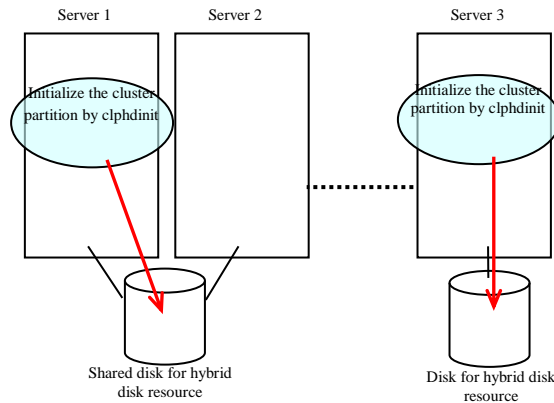

7. Run the following command on a server. When servers are connected to the shared disk, run the command on the server where the command in previous step was executed.

```
# mkfs -t <Type of Filesystem> <Data Partition>
```

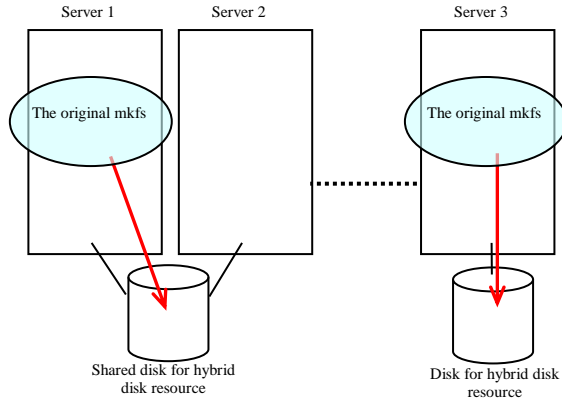

8. Run the chkconfig command in the following order to start the EXPRESSCLUSTER services.

```
# chkconfig --add clusterpro_md
# chkconfig --add clusterpro
```

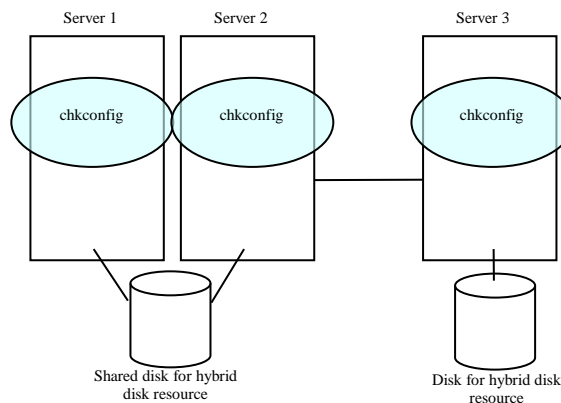

9. Run the reboot command to restart all servers. The servers are started as a cluster.
10. After the cluster is started, the same process as the initial mirror construction at cluster creation is performed. Run the following command or use the WebManager to check if the initial mirror construction is completed.

```
# clphdstat --mirror <hybrid_disk_resource_name>
```



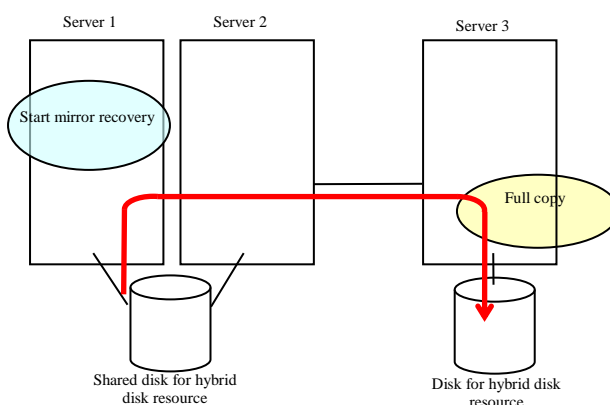

- When the initial mirror construction is completed and a failover group starts, a hybrid disk resource becomes active.

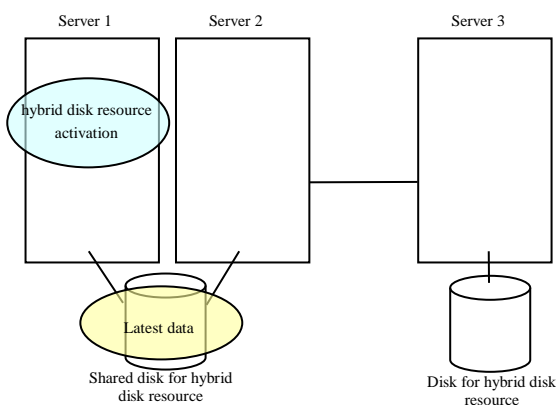

- On the server where a group with the partition whose size you changed is activated, restore the data you backed up. Note that backup commands that access a partition device directly are not supported. This step is not required if there is no problem to discard the data on a hybrid disk resource.

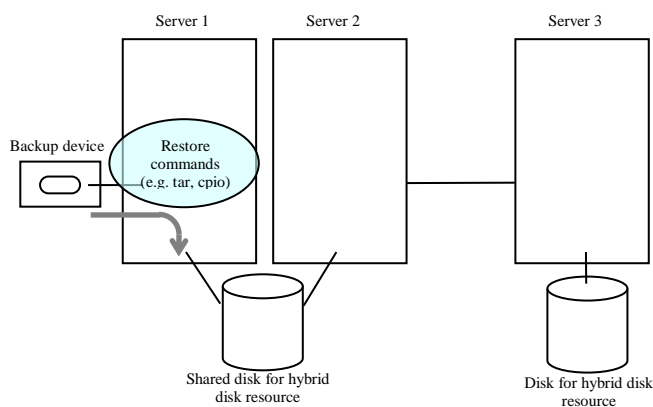

## When changing a device name of a partition on hybrid resource

1. Check the name of a hybrid disk resource whose size you want to change by the `clpstat` command or by the WebManager.
2. On the server where a group with the hybrid disk resource whose size you want to change is activated, back up the data in a partition to a device such as tape. Note that backup commands that access a partition device directly are not supported. This step is not required if destroying the data on the hybrid disk resource does not cause any problem.

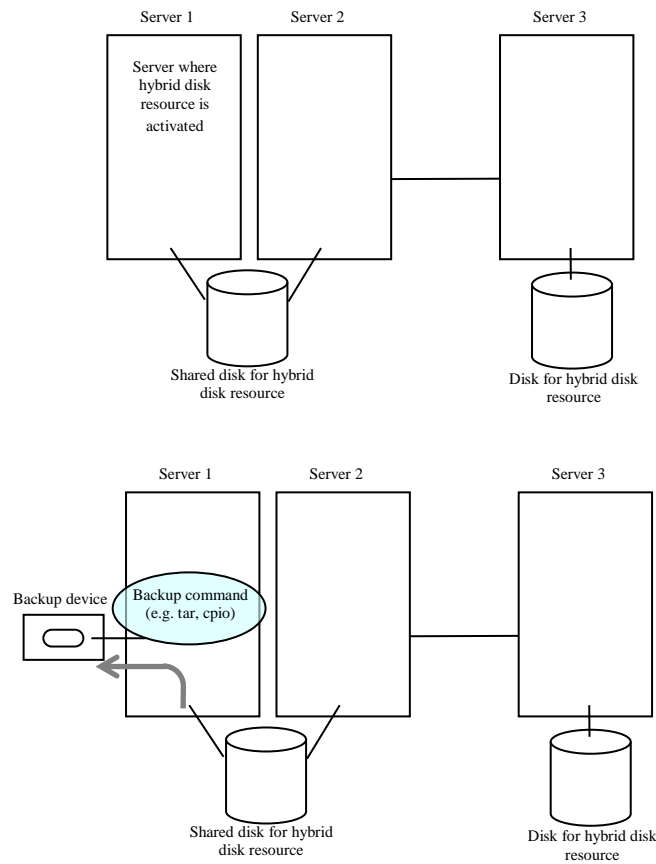

- Run the `chkconfig` command in the following order not to start the EXPRESSCLUSTER services. In SUSE Linux, run the command with the `--force` option.

```
# chkconfig --del clusterpro
# chkconfig --del clusterpro_md
```

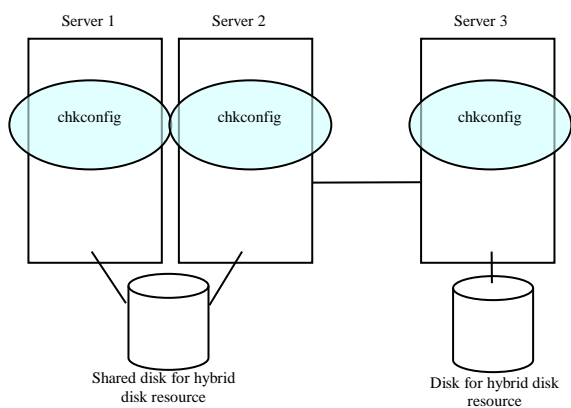

- Shut down a cluster, and then restart the OS. To shut down a cluster, run the `clpstdn` command on either of a server, or execute a cluster shutdown on the WebManager.

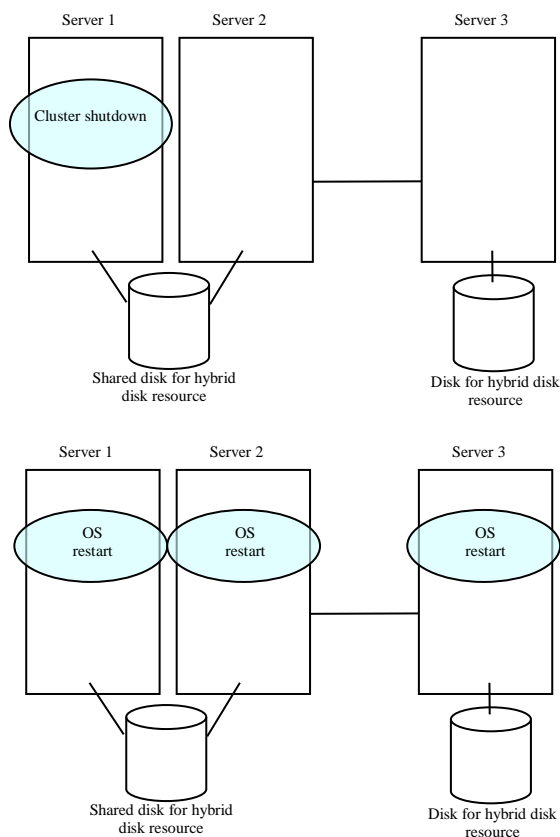

5. On a server, run the fdisk command to change the offset or size of a partition. When servers are connected to the shared disk, run the fdisk command from either of servers to change.

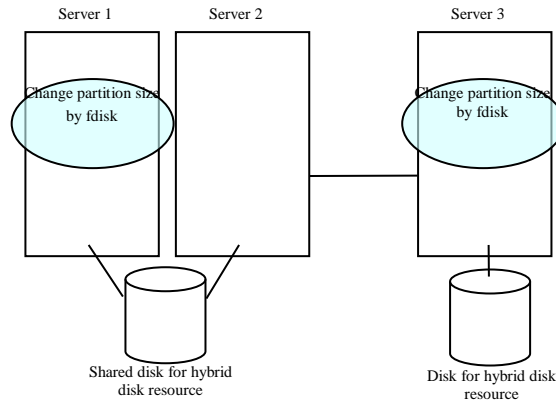

6. Change and upload the cluster configuration data. Change a hybrid disk resource as described in “Modifying the cluster configuration data by using the EXPRESSCLUSTER Builder (online version)” or “Modifying the cluster configuration data by using the EXPRESSCLUSTER Builder (offline version)” in Chapter 7, “Modifying the cluster configuration data” in the *Installation and Configuration Guide*. See the corresponding steps as those are different depending on using the online or offline version Builder.

7. Run the following command on the server. When servers are connected to the shared disk, execute the command on the server where the command was executed in step 5.

```
# clphdinit --create force <Hybrid_disk_resource_name>
```

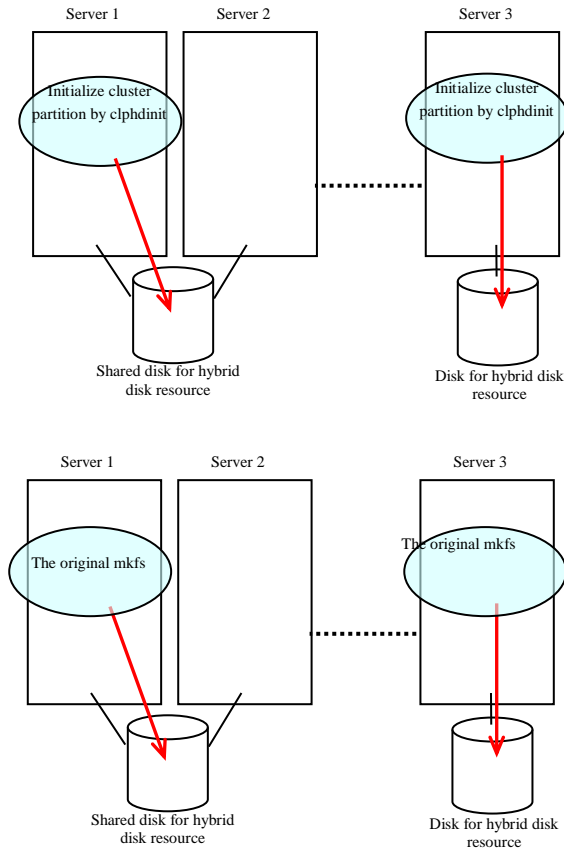

8. Run the `chkconfig` command in the following order to start the EXPRESSCLUSTER services.

```
# chkconfig --add clusterpro_md
# chkconfig --add clusterpro
```

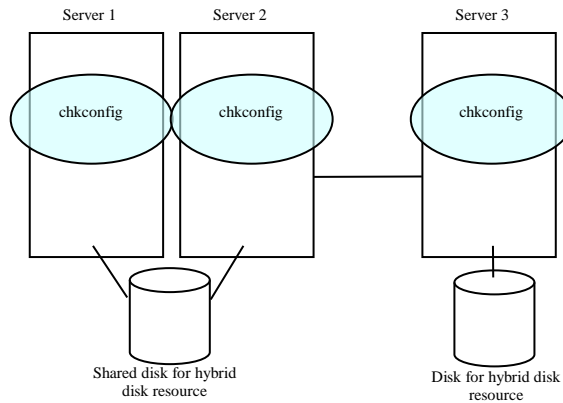

9. Run the `reboot` command to restart all servers. The servers are started as a cluster.
10. After the cluster is started, the same process as the initial mirror construction at cluster creation is performed. Run the following command or use the WebManager to check if the initial mirror construction is completed.

```
# clphdstat --mirror <Hybrid_disk_resource_name>
```

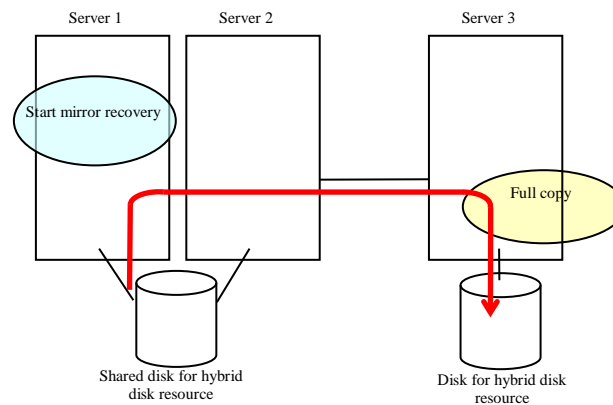

11. When the initial mirror construction is completed and a failover group starts, a hybrid disk resource becomes active.

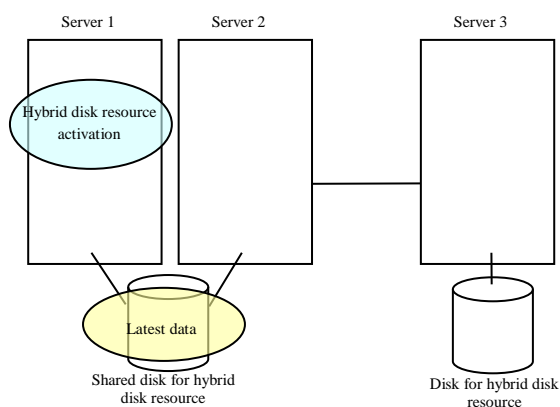

12. On the server where a group with the partition whose size you changed is activated, restore the data you backed up. Note that backup commands that access a partition device directly are not supported. This step is not required if there is no problem to discard the data on the hybrid disk resource.

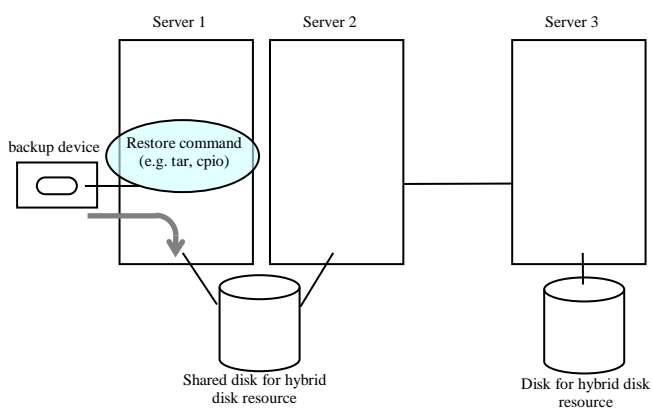

## Changing the server configuration (add/delete)

### Adding a server (when using online version)

Connect to the WebManager with a management IP address. If you do not have any management IP address, connect to it by using the actual IP address of any server.

---

**Important:**

When adding a server in changing the cluster configuration, do not make any other changes such as adding a group resource.

---

1. Make sure that the cluster is working normally.

Install the EXPRESSCLUSTER Server on a new server. For details, see “Setting up the EXPRESSCLUSTER Server Installing the EXPRESSCLUSTER RPM” in Chapter 3, “Installing EXPRESSCLUSTER” in the *Installation and Configuration Guide*. Restart the server on which the EXPRESSCLUSTER Server was installed.

2. From the **Service** menu on the WebManager, click **Suspend Cluster**.
3. Start the online version Builder on the WebManager you connected to.
4. Upload the updated cluster configuration data on the Builder.
5. From the **Service** menu on the WebManager, click **Restart Manager** and then **Resume Cluster**.

---

**Note:** If you resume the cluster from the WebManager, the error message “**Failed to resume the cluster. Click the Reload button, or try again later.**” is displayed, but ignore it. This is displayed because the new server has not been suspended.

---

6. Restart the added server.
7. Click **Reload** on the WebManager to verify the cluster is properly working.

### Adding a server (when using offline version Builder)

To add a server to/from a cluster, first it is required to prepare the floppy disk where the latest cluster configuration data is stored.

If you do not have the floppy disk with the latest data created (or changed its configuration by the Builder) at hand, you can back up the data with the `clpcfctrl` command.

---

**Important:**

When adding a server in changing the cluster configuration, do not make any other changes such as adding a group resource.

---

1. Make sure that the cluster is working normally.

Install the EXPRESSCLUSTER Server on a new server. For details, see “Setting up the EXPRESSCLUSTER Server Installing the EXPRESSCLUSTER RPM” in Chapter 3, “Installing EXPRESSCLUSTER” in the *Installation and Configuration Guide*. Restart the server on which the EXPRESSCLUSTER Server was installed.

2. Change the cluster configuration data (in the prepared floppy disk) by the Builder.



3. On the current master server of the cluster system, run the `clpctl --suspend` command to suspend the EXPRESSCLUSTER daemon of the master server.
4. Insert the floppy disk into the floppy disk driver of the master server.
5. Distribute the configuration data in the floppy disk from the master server. Do either A or B depending on the floppy disk type you used to save the data by the Builder:

- If your floppy disk has the data saved by the Builder on Linux, run the following command:

```
clpcfctrl --push -l --nocheck
```

- If your floppy disk (1.44-MB formatted) has the data saved by the Builder on Windows, or has the data for Windows saved by the Builder on Linux, run the following command:

```
clpcfctrl --push -w --nocheck
```

The following message is shown if the data has successfully been distributed.

```
Command succeeded. (code:0)
```

For information on troubleshooting `clpcfctrl` problems, see “Creating a cluster and backing up configuration data (`clpcfctrl` command)” in Chapter 3, “EXPRESSCLUSTER command reference” in this guide.

6. From the **Service** menu on the WebManager, click **Restart Manager** and then run `clpctl --resume` on the master server to resume the EXPRESSCLUSTER daemon. The following error message is always displayed for the added server. This is because the added server is not suspended. Ignore the message and proceed to the next step.  
Resume *server* : Failed invalid server status.  
(*server* : Added server name)
7. From the **Service** menu in the WebManager, select **Restart Manager** and then **Start Cluster**.
8. Click **Reload** on the WebManager to verify the cluster is properly working.

## Deleting a server (When using online version Builder)

Connect to the WebManager with a management IP address. If you do not have any management IP address, connect to it by using the actual IP address of any server.

---

**Important:**

When adding a server in changing the cluster configuration, do not make any other changes such as adding a group resource.

---

1. Make sure that the cluster is working normally. If any group is active on the server you are going to delete, move the group to another server.
2. From the **Service** menu on the WebManager, click **Stop Cluster**.
3. Uninstall the EXPRESSCLUSTER Server from the server you are going to delete. For details, see “Uninstallation Uninstalling the EXPRESSCLUSTER Server” in Chapter 10, “Uninstalling and reinstalling EXPRESSCLUSTER” in the *Installation and Configuration Guide*.
4. Start the online version Builder on the WebManager you connected to.
5. Upload the updated cluster configuration data on the Builder.
6. From the **Service** menu on the WebManager, click **Restart Manager** and then **Start Cluster**.
7. Click **Reload** on the WebManager to verify the cluster is properly working.

## Deleting a server (When using offline version Builder) - When no mirror disk resources are used in a cluster -

To delete a server from a cluster, first it is required to prepare the floppy disk where the latest cluster configuration data is stored.

If you do not have the floppy disk with the latest data created (or changed its configuration by the Builder) at hand, you can back up the data with the `clpcfctrl` command.

---

**Important:** When deleting a server in changing the cluster configuration, do not make any other changes such as adding a group resource.

---

1. Make sure that the cluster is working normally. If any group is active on the server you are going to delete, move the group to another server.
2. On a server in the cluster other than the one you are going to delete or on the master server if any, run the `clpcl -suspend` command to suspend the EXPRESSCLUSTER daemon.
3. Uninstall the EXPRESSCLUSTER Server from the server you are going to delete. For details, see “Uninstallation Uninstalling the EXPRESSCLUSTER Server” in Chapter 10, “Uninstalling and reinstalling EXPRESSCLUSTER” in the *Installation and Configuration Guide*.
4. Change the cluster configuration (in the prepared floppy disk) by using the Builder.
5. Run the `clpcfctrl` command on the master server to apply the configuration data to the servers. Do either A or B depending on the floppy disk type you used to save the data by the Builder:
  - If your floppy disk has the data saved by the Builder on Linux, run the following command.

```
clpcfctrl --push -l --nocheck
```

EXPRESSCLUSTER X 3.3 for Linux Reference Guide

- If your floppy disk (1.44-MB formatted) has the data saved by the Builder on Windows, or has the data for Windows saved by the Builder on Linux, run the following command.

```
clpcfctrl --push -w --nocheck
```

The following message is shown if the data has successfully been distributed.

```
Command succeeded. (code:0)
```

6. Run the `clpcl --resume` command to resume the EXPRESSCLUSTER daemon on the master server.
7. Click **Reload** on the WebManager to verify the cluster is properly working.

## Deleting a server (When using offline version Builder) - When mirror disk resources are used in a cluster -

To add a server to a cluster, first it is required to prepare the floppy disk where the latest cluster configuration data is stored.

If you do not have the floppy disk with the latest data created (or changed its configuration by the Builder) at hand, you can back up the data with the `clpcfctrl` command.

---

**Important:** When deleting a server in changing the cluster configuration, do not make any other changes such as adding a group resource.

---

1. Make sure that the cluster is working normally. If any group is active on the server you are going to delete, move the group to another server.
2. On a server in the cluster other than the one you are going to delete or on the master server if any, run the `clpcl -t -a` command to stop the EXPRESSCLUSTER daemon.
3. Uninstall the EXPRESSCLUSTER Server from the server you are going to delete. For details, see “Uninstallation Uninstalling the EXPRESSCLUSTER Server” in Chapter 10, “Uninstalling and reinstalling EXPRESSCLUSTER” in the *Installation and Configuration Guide*.
4. Change the cluster configuration (in the prepared floppy disk) by using the Builder.
5. Run the `clpcfctrl` command on the master server to apply the configuration data to the servers. Do either A or B depending on the floppy disk type you used to save the data by the Builder:

- If your floppy disk has the data saved by the Builder on Linux, run the following command.

```
clpcfctrl --push -l --nocheck
```

- If your floppy disk (1.44-MB formatted) has the data saved by the Builder on Windows, or has the data for Windows saved by the Builder on Linux, run the following command.

```
clpcfctrl --push -w --nocheck
```

The following message is shown if the data has successfully been distributed.

```
Command succeeded. (code:0)
```

6. Run the `clpcl -s -a` command to start the EXPRESSCLUSTER daemon on the master server.
7. Click **Reload** on the WebManager to verify the cluster is properly working.

## Changing the server IP address

To change the server IP address after you have started the cluster system operation, follow the instructions below.

### Changing the interconnect IP address / mirror disk connect IP address

1. Use the `clpstat` command or the WebManager to verify all servers in the cluster are working normally.
2. Back up the cluster configuration data. Use the `clpcfctrl` command to back up the data in a floppy disk.  
If you have the floppy disk that contains the data at the cluster creation, use that floppy disk.
3. Use the Builder to change the server IP address based on the cluster configuration data in the floppy disk, and then save it in the floppy disk
4. Disable the startup settings of the EXPRESSCLUSTER daemon in all servers in the cluster. For more information, see “Suspending EXPRESSCLUSTER Disabling the EXPRESSCLUSTER daemon” in Chapter 9, “Preparing to operate a cluster system” in the *Installation and Configuration Guide*.
5. Use the `clpstdn` command or the WebManager to shut down the cluster, and then restart all servers.
6. Change the IP address. If a server reboot is required after changing the IP address, run the reboot command or use other means on the server where the IP address has changed.
7. Verify the changed IP address is valid by running the ping command or using other means.
8. Distribute the cluster configuration data to all the servers. Use the `clpcfctrl` command to deliver the data from the floppy disk.
9. Enable the startup settings of the EXPRESSCLUSTER daemon in all servers in the cluster.
10. Run the reboot command or use other means on all servers in the cluster to reboot them.
11. Use the `clpstat` command or the WebManager to verify all servers in the cluster are working normally.

## Changing only the subnet mask of the interconnect IP address

1. Use the `clpstat` command or the WebManager to verify all servers in the cluster are working normally.
2. Back up the cluster configuration data. Use the `clpcfctrl` command to back up the data in a floppy disk.  
If you have the floppy disk that contains the data at the cluster creation, use that floppy disk.
3. Use the Builder to change the server IP address based on the cluster configuration data in the floppy disk, and then save it in the floppy disk.
4. Disable startup settings of the EXPRESSCLUSTER daemon in all servers in the cluster.
5. Use the `clpstdn` command or the WebManager to shut down the cluster, and then restart all servers.
6. Change the subnet mask of the IP address. If server reboot is required after changing the subnet mask of IP address, run the `reboot` command or use other means on the server where the subnet mask of the IP address has been changed.
7. Verify the changed IP address is valid by running the `ping` command or using other means.
8. Distribute the cluster configuration data to all servers. Use the `clpcfctrl` command to deliver the data from the floppy disk.
9. Enable the startup settings of the EXPRESSCLUSTER daemon in all servers in the cluster.
10. Run the `reboot` command or use other means on all the servers in the cluster.
11. Use the `clpstat` command or the WebManager to verify all the servers in the cluster are working normally.

## Changing the integrated WebManager IP address

To change the integrated WebManager IP address, follow the instructions for changing the interconnect IP address. IP address for Integrated WebManager can be changed by **IP address for Integrated WebManager** on the **WebManager** tab of **Cluster Properties** in Builder.

## Changing only the subnet mask of the integrated WebManager IP address

To change the subnet mask of the integrated WebManager IP address, follow the instructions for changing the subnet mask of the interconnect IP address.

## Changing the host name

Follow the steps below if you want to change the host name of a server after you have started the cluster system operation.

### Changing the host name

1. Use the `clpstat` command or the WebManager to verify all the servers in the cluster are working normally.
2. Back up the cluster configuration data. Use the `clpcfctrl` command to back up the data in a floppy disk. .  
If you have the floppy disk that contains the data at the cluster creation, use that floppy disk
3. Use the Builder to change the host name of your target server based on the cluster configuration data in the floppy disk, and then save it in the floppy disk.
4. Disable the startup settings of the EXPRESSCLUSTER daemon in all servers in the cluster. For more information, see “Suspending EXPRESSCLUSTER Disabling the EXPRESSCLUSTER daemon” in Chapter 9, “Preparing to operate a cluster system” in the *Installation and Configuration Guide*.
5. Use the `clpstdn` command or the WebManager to shut down the cluster, and then restart all the servers.
6. Change the host name. If the server needs to be rebooted after changing the host name, run the `reboot` command or use other means on the server.
7. Verify the changed host name is valid by running the `ping` command or using other means.
8. Distribute the cluster configuration data to all the servers. Use the `clpcfctrl` command to deliver the data from the floppy disk.
9. Enable the startup settings of the EXPRESSCLUSTER daemon in all servers in the cluster.
10. Run the `reboot` command or use other means on all the servers in the cluster to reboot them.
11. Use the `clpstat` command or the WebManager to verify all the servers in the cluster are in the normal status.

---

#### Related Information:

For information on troubleshooting `clpcfctrl` problems, see “Creating a cluster and backing up configuration data (`clpcfctrl` command)” in Chapter 3, “EXPRESSCLUSTER command reference” in this guide.

For details on how to stop and start daemons, see “Suspending EXPRESSCLUSTER” in Chapter 9, “Preparing to operate a cluster system” in the *Installation and Configuration Guide*.

---

## How to add a resource without stopping the group

You can add, to a group that is already running, a resource that supports dynamic resource addition without stopping the group.

Group resources that currently support dynamic resource addition are as follows:

Group resource name	Abbreviation	Supported version
Exec resource	exec	3.2.1-1 or later
Disk resource	disk	3.2.1-1 or later
Floating IP resource	fip	3.2.1-1 or later
Virtual IP resource	vip	3.2.1-1 or later
Volume manager resource	volmgr	3.2.1-1 or later

**Related information:** If all the resources in the group to which the resource to add will belong have been started normally, the resource to add will also be started.

If at least one of the resources in the group to which the resource to add will belong is in the activation or deactivation error state, the dynamic resource addition function will be disabled and group stoppage will be requested. If the group is in the stopped state, the resource will be added and placed in the stopped state.

Perform the following procedure to dynamically add a resource after starting the operation.

### How to dynamically add a resource

1. Confirm that all servers in the cluster are operating normally by running the [clpstat] command or using the WebManager.
2. Confirm that all resources in the group to which a resource is added are started normally by running the [clpstat] command or using the WebManager.
3. Use the Builder to add a resource to the group and save it in a filesystem on Linux or floppy disk.
4. Run the [clpcl --suspend] command or use the WebManager to suspend the cluster.
5. Distribute the cluster configuration data to all the servers. Run the [clpcfctrl] command to deliver the data from the filesystem on Linux or floppy disk. Run the following command to dynamically add a resource.

If the Builder is executed to save the configuration information in a file system, use one of the steps below depending on the type of FD saved.

- To deliver the configuration information file saved on a file system on Linux by using Builder, execute the command below.

```
clpcfctrl --dpush -l -x <directory storing configuration file>
```

- If the Builder is used on Windows to save a configuration information file, or to deliver the configuration information file saved for Windows by executing the Builder on Linux, execute the command below.

```
clpcfctrl --dpush -w -x <directory storing configuration file>
```

- To use the FD created for Linux by using the Builder, execute the command below.

```
clpcfctrl --dpush -l
```

- To use the FD (1.44MB format) created for Windows by using the Builder, execute the following command.

```
clpcfctrl --dpush -w
```

6. Run the [clpcl --resume] command or use the WebManager to resume the cluster.
7. Confirm that the resource has been added by running the [clpstat] command or using the WebManager.

---

**Related Information:** For information on troubleshooting [clpcfctrl] problems, see “Creating a cluster and backing up configuration data (clpcfctrl command)” in Chapter 3, “EXPRESSCLUSTER command reference” in this guide.

---



# Chapter 11 Troubleshooting

This chapter provides instructions for troubleshooting problems with EXPRESSCLUSTER.

This chapter covers:

- Troubleshooting ..... 1366
- Troubleshooting problems with VERITAS volume manager ..... 1406
- When a kernel page allocation error occurs ~ For Replicator / Replicator DR~ ..... 1412
- To confirm the progress of the fsck / xfs\_repair command ..... 1413

# Troubleshooting

The following provides instructions for troubleshooting problems you experience in operating the EXPRESSCLUSTER system.

## When the EXPRESSCLUSTER system does not start or end

A cluster system starts working by restarting servers after installing EXPRESSCLUSTER. If your cluster system does not behave properly, check the following:

### 1. Registration of cluster configuration data

The cluster configuration data should be registered with all servers (which will form a cluster system) when you cluster them. If the cluster configuration data does not exist in the following path, the data may not be registered yet. Check it is registered.

```
/opt/nec/clusterpro/etc/clp.conf
```

If the cluster configuration data does not exist in the above path, see Chapter 5, “Creating the Cluster Configuration Data” in the *Installation and Configuration Guide* for registering the data.

### 2. Server names and IP addresses in the cluster configuration data

Check the server names and IP addresses are valid.

```
(# hostname, # ifconfig....)
```

### 3. License registration

The license may not be registered yet. Run the following command on all servers in the cluster to confirm the license is registered:

```
# clplcncs -l -p PRODUCT-ID
```

Use the product ID for **PRODUCT-ID**, which is specified in the -p option. See “Managing licenses (clplcncs command)” in Chapter 3, “EXPRESSCLUSTER command reference” in this guide for more information on product IDs.

If you are using the trial version license, confirm if it is not expired yet.

### 4. EXPRESSCLUSTER run level

Run the following command to check the run level of EXPRESSCLUSTER:

```
# chkconfig --list clusterpro
```

```
clusterpro    0:off 1: off  2: off  3: on  4: off  5:on  6:
off
```

### 5. Cluster process status

Run the following command to check if EXPRESSCLUSTER is working properly:

```
# ps -ef | grep clp
```

```
root  1669      1 0 00:00  ? 00:00:00  clpmonp -event -a 2 -r
0 -w 0
root  1670    1669 0 00:00  ? 00:00:00  clpevent
root  1684      1 0 00:00  ? 00:00:00  clpmonp -trnsv -a 2 -r
0 -w 0
root  1685    1684 0 00:00  ? 00:00:00  clptrnsv
root  1784      1 0 00:00  ? 00:00:00
/opt/nec/clusterpro/bin/clppm
root  1796    1795 0 00:00  ? 00:00:00  clprc
root  1809    1808 0 00:00  ? 00:00:00  clprm
root  1813    1812 0 00:00  ? 00:00:00  clpnm
root  1818    1813 0 00:00  ? 00:00:00  clplanhb
```

EXPRESSCLUSTER X 3.3 for Linux Reference Guide

```

root    1820    1813 0 00:00  ? 00:00:00    clpdiskhb
root    1822    1813 0 00:00  ? 00:00:00    clpcomhb
root    1823    1813 0 00:00  ? 00:00:00    clplankhb

root    1935      1 0 00:00  ? 00:00:00    clpmonp -webmgr -a 2 -o
-start -r 0 -w 0
root    1936    1935 0 00:00  ? 00:00:00    clpwebmc -start
root    1947      1 0 00:00  ? 00:00:00    clpmonp -webalert -a 2
-r 0 -w 0
root    1948    1947 0 00:00  ? 00:00:00    clpaltld

```

If you can check the run statuses of the following processes by executing the ps command, EXPRESSCLUSTER is working properly.

- Event process and data transfer process

```

root    1685    1684 0 00:00  ? 00:00:00    clptrnsv
root    1669      1 0 00:00  ? 00:00:00    clpmonp -event
root    1670    1669 0 00:00  ? 00:00:00    clpevent
root    1684      1 0 00:00  ? 00:00:00    clpmonp -trnsv

```

If the event process is not started yet, the process manager described in the following section will not start.

- Process manager

```

root    1784      1 0 00:00  ? 00:00:00
/opt/nec/clusterpro/bin/clppm

```

By starting up this process, the following processes are generated. Therefore, if any error such as error in cluster configuration data file is detected, EXPRESSCLUSTER will not start.

```

clprc
clprm
clpnm

```

- Resource control process:

```

root    1796    1795 0 00:00  ? 00:00:00    clprc

```

\* This process can start up even if no group resources are registered yet.

- Resource monitor process:

```

root    1809    1808 0 00:00  ? 00:00:00    clprm

```

\* This process can start up even if no monitor resources are registered yet.

- Server management process:

```

root    1813    1812 0 00:00  ? 00:00:00    clpnm

```

- Heartbeat process:

```

root    1813    1821 0 00:00  ? 00:00:00    clpcomhb
root    1813    1817 0 00:00  ? 00:00:00    clplanhb
root    1813    1819 0 00:00  ? 00:00:00    clpdiskhb
root    1823    1813 0 00:00  ? 00:00:00    clplankhb

```

If a disk heartbeat resource has been added to the heartbeat resources in the cluster configuration data, clpdiskhb is started. If a COM interface has been added, clpcomhb is started. If a kernel mode LAN heartbeat resource has been added, clplankhb is started.

- WebManager process:

```

    root  1936  1935 0 00:00  ? 00:00:00    clpwebmc -start
  • Alert process:
    root  1948  1947 0 00:00  ? 00:00:00    clpaltd

```

The display style of the ps command may look different from the above depending on the distribution.

## 6. Cluster process status ~ For Replicator~

Run the following commands to check if EXPRESSCLUSTER is working properly:

```

# ps -ef | grep clp
root  1669      1 0 00:00  ? 00:00:00    clpmonp -event -a 2 -r
0 -w 0
root  1670  1669 0 00:00  ? 00:00:00    clpevent
root  1684      1 0 00:00  ? 00:00:00    clpmonp -trnsv -a 2 -r
0 -w 0
root  1685  1684 0 00:00  ? 00:00:00    clptrnsv
root  1696      1 0 00:00  ? 00:00:00    clpmonp -mdagent -a 5
-r 0 -w 30
root  1697  1696 0 00:00  ? 00:00:00    clpmdagent
root  1784      1 0 00:00  ? 00:00:00
/opt/nec/clusterpro/bin/clppm
root  1796  1795 0 00:00  ? 00:00:00    clprc
root  1809  1808 0 00:00  ? 00:00:00    clprm
root  1813  1812 0 00:00  ? 00:00:00    clpnm
root  1818  1813 0 00:00  ? 00:00:00    clplanhb
root  1822  1813 0 00:00  ? 00:00:00    clpcomhb
root  1823  1813 0 00:00  ? 00:00:00    clplankhb
root  1935      1 0 00:00  ? 00:00:00    clpmonp -webmgr -a 2 -o
-start -r 0 -w 0
root  1936  1935 0 00:00  ? 00:00:00    clpwebmc -start
root  1947      1 0 00:00  ? 00:00:00    clpmonp -webalert -a 2
-r 0 -w 0
root  1948  1947 0 00:00  ? 00:00:00    clpaltd

```

If you can check the run statuses of the following processes by executing the ps command, EXPRESSCLUSTER is working properly.

- Event process, data transfer process, and mirror agent
 

```

root  1696      1 0 00:00  ? 00:00:00    clpmonp --mdagent
-a 5 -r 0 -w 30
root  1697  1696 0 00:00  ? 00:00:00    clpmdagent

```

If the event process is not started yet, the process manager in the following section will not start.

- Process manager
 

```

root  1784      1 0 00:00  ? 00:00:00
/opt/nec/clusterpro/bin/clppm

```

By starting up this process, the following processes are generated. Therefore, if any error such as error in cluster configuration data file is detected, EXPRESSCLUSTER will not start.

```
clprc
clprm
clpnm
```

- Resources control process:

```
root 1796 1795 0 00:00 ? 00:00:00 clprc
```

\* This process can start up even if no group resources are registered yet.

- Resource monitor process:

```
root 1809 1808 0 00:00 ? 00:00:00 clprm
```

\* This process can start up even if no monitor resources are registered yet.

- Server management process:

```
root 1813 1812 0 00:00 ? 00:00:00 clpnm
```

- Heartbeat process:

```
root 1822 1813 0 00:00 ? 00:00:00 clpcomhb
```

```
root 1818 1813 0 00:00 ? 00:00:00 clplanhb
```

```
root 1823 1813 0 00:00 ? 00:00:00 clplankhb
```

If a COM heartbeat resource has been added to the heartbeat resources in the cluster configuration data, clpcomhb is started. If a kernel mode LAN heartbeat resource has been added, clplankhb is started.

- WebManager process:

```
root 1936 1935 0 00:00 ? 00:00:00 clpwebmc -start
```

- Alert process:

```
root 1948 1947 0 00:00 ? 00:00:00 clpaltd
```

The display style of the ps command may look different from the above depending on the distribution.

#### 7. Loading of the mirror driver ~For Replicator~

Run the lsmod command. Check that the run result of lsmod contains the following loadable module.

```
Liscal
```

#### 8. Loading of the kernel mode LAN heartbeat driver ~For kernel mode LAN heartbeat resource~

Run the lsmod command. Check that the run result of lsmod contains the following loadable module.

```
clpkhb
```

#### 9. Loading of the keepalive driver ~For userw user-mode monitor resource (keepalive)~

Run the lsmod command. Check that the run result of lsmod contains the following loadable module.

```
clpka
```

#### 10. Normal startup of the cluster from syslog

To see EXPRESSCLUSTER processes are working properly by looking into syslog, find the following messages.

- To check the process manager's startup:

```
<type: pm><event: 1> Cluster daemon has started properly...
```

- To check heartbeat resources' activation:

```
<type: nm><event: 3> Resource lanhb1 of server server1 up.
```

```
<type: nm><event: 3> Resource diskhb1 of server server1 up.
```

```
<type: nm><event: 1> Server server1 up.
```

```
<type: nm><event: 3> Resource diskhb1 of server server2 up.  
<type: nm><event: 1> Server server2 up.  
<type: nm><event: 3> Resource lanhb1 of server server2 up.
```

You will see the above messages when the followings are specified for heartbeat resources in a 2-node configuration.

```
lanhb1    LAN heartbeat resources  
diskhb1   Disk heartbeat resources
```

- To check group resources' activation:

```
<type: rc><event: 10> The start processing of a group grp1  
started.
```

```
<type: rc><event: 30> The start processing of a resource fip1  
started.
```

```
<type: rc><event: 31> The start processing of a resource fip1  
ended.
```

```
<type: rc><event: 30> The start processing of a resource disk1  
started.
```

```
<type: rc><event: 31> The start processing of a resource disk1  
ended.
```

```
<type: rc><event: 11> The start processing of a group grp1 ended.
```

You will see the above messages when the group resource, grp1, is activated on server1. The group resources' configuration data is as follows:

```
fip1      Floating IP addresses resources  
disk1     Shared disk resources
```

- To check monitor resources' startup:

```
<type: rm><event: 1> Monitor userw start.
```

```
<type: rm><event: 1> Monitor ipw1 start.
```

You will see the above messages when the monitor resources are specified as follows:

```
userw     User-mode monitor resources  
ipw1     IP monitor resources
```

- To check license consistency:

Product version

```
<type: rm><event: 50> The number of license is 2. (BASE30)
```

You will see the above message when 2-CPU license is registered.

Trial version

```
<type: rm><event: 51> Period of trial is till 2003/09/30.  
(BASE30)
```

#### 11. Successful startup of the cluster ~For Replicator~

To see EXPRESSCLUSTER processes are working properly by looking into syslog, find the following messages.

- To check the mirror agent's startup:

```
<type: mdagent><event: 1> Agent has started successfully.
```

- To check the mirror driver's startup:

```
<type: liscal><event: 101> Registered blkdev with major=218.
```

- To check the process manager's startup:

```
<type: pm><event: 1> Cluster daemon has started properly...
```

- To check heartbeat resources' activation:

```
<type: nm><event: 3> Resource lanhb1 of server server1 up.
<type: nm><event: 1> Server server1 up.
<type: nm><event: 3> Resource lanhb1 of server server2 up.
<type: nm><event: 1> Server server2 up.
```

You will see the above messages when the following is specified for heartbeat resources in a 2-node configuration.

```
lanhb1      LAN heartbeat resources
```

- To check group resources' activation:

```
<type: rc><event: 10> The start processing of a group grp1
started.
<type: rc><event: 30> The start processing of a resource fip1
started.
<type: rc><event: 31> The start processing of a resource fip1
ended.
<type: rc><event: 30> The start processing of a resource md1
started.
<type: rc><event: 31> The start processing of a resource md1
ended.
<type: rc><event: 11> The start processing of a group grp1 ended.
```

You will see the above messages when the group resource, grp1, is activated on server1. The group resources' configuration data is as follows;

```
fip1        Floating IP addresses resources
md1         Mirror disk resources
```

- To check start of monitoring by monitoring resources:

```
<type: rm><event: 1> Monitor userw start.
<type: rm><event: 1> Monitor ipw1 start.
<type: rm><event: 1> Monitor mdw1 start.
<type: rm><event: 1> Monitor mdw1 start.
```

You will see the above messages when the monitor resources are specified as follows;

```
userw      User-mode monitor resources
ipw1       IP monitor resources
mdw1       Mirror disk monitor resources
mdnw1      Mirror disks connect monitor resources
```

- To check license consistency:

Product version

```
<type: rm><event: 50> The number of license is 2. (BASE30)
```

You will see the above message when a 2-CPU license is registered.

Trial version

```
<type: rm><event: 51> Period of trial is till 2006/09/30.
(BASE30)
```

## 12. Free disk space

Run the df command to check the size of the free disk space in the file system that contains /opt/nec/clusterpro. For details on the disk space to be used by the EXPRESSCLUSTER Server, see Chapter 3, "Installation requirements for EXPRESSCLUSTER" in *Getting Started with Guide*.

## 13. Usage of memory or OS resource

Run the top or free command to check the OS memory usage and CPU utilization.

## When activating or deactivating group resources fails

If any error is detected in activation of a group resource, detailed error information is logged in the alert and syslog. Examine the logs to find the cause of the error and take appropriate action for it.

1. Floating IP resource  
Check that the specified IP address is not already used on the network or you have not specified an IP address of a wrong network segment.  
For more information on errors, see Floating IP resources on 1511.
2. Disk resources  
Check that the device and mount point exist, and the file system is configured.  
For more information on errors, see “Disk resources” on page 1512.
3. EXEC resources  
Check that the script path is correct and what is scripted is appropriate.  
For more information on errors, see “EXEC resources” on page 1515.
4. Mirror disk resources ~For Replicator~  
Check that the devices and mount points exist, and the cluster partitions and data partitions are allocated. Check the file system specified for mirror disk resources is available as well.  
For more information on errors, see “Mirror disk resources” on page 1516.
5. Hybrid disk resources ~For Replicator DR~  
Check that the devices and mount points exist, and the cluster partitions and data partitions are allocated. Check the file system specified for mirror disk resources is available as well.  
For more information on errors, see “Hybrid disk resources” on page 1517.

## When a monitor resource error occurs

If a monitor resource detects any error, detailed information on error is logged in the alert and syslog. Examine the logs to find the cause of the error and take appropriate action for it.

1. Error detected by the IP monitor resource  
Check that you can send packets with the ping command, and other network segments are routed if any.  
For more information on errors, see “IP monitor resources” on page 1523.
2. Error detected by the disk monitor resource  
Check that a disk device exists. If you are using a shared disk, check SCSI or fibre cables are securely connected to the shared disk.  
For more information on errors, see “Disk monitor resources” on page 1523.
3. Error detected by the PID monitor resource  
Check that the process to be monitored exists by using a command, such as ps command.  
For more information on errors, see “PID monitor resources” on page 1526.
4. Error detected by the user-mode monitor resource



Check that you can load the softdog driver by the insmod command, and the user space is not heavily loaded.

For more information on errors, see “User-mode monitor resources” on page 1526.

5. Error detected by the mirror disk monitor resource ~For Replicator~

Check that the disk devices exist, and the cluster partitions and data partitions are allocated. Confirm that the Mirror Agent is active.

For more information on errors, see “Mirror disk monitor resources” on page 1527.

6. Error detected by the mirror disks connect monitor resource ~For Replicator~

Check that the mirror disk is connected and the Mirror Agent is active.

For more information on errors, see “Mirror disk connect monitor resources” on page 1529.

7. Error detected by the hybrid disk monitor resource ~For Replicator DR~

Check that the mirror disk is connected and the Mirror Agent is active.

For more information on errors, see “Mirror disk monitor resources” on page 1527.

8. Error detected by the hybrid disk connect monitor resource ~For Replicator DR~

Check that the mirror disk is connected and the Mirror Agent is active.

For more information on errors, see “Hybrid disk connect monitor resources” on page 1532.

9. Error detected by the NIC Link Up/Down monitor resource

Check how the NIC of the server is connected to the network device.

For more information on errors, see “NIC link up/down monitor resources” on page 1533.

## When a heartbeat time-out occurs

Possible causes of heartbeat time-out between servers are listed below:

Cause	Solution
Disconnection of LAN/disk/COM cables	For disk or COM cables, check if the cables are connected securely.  For LAN cables, check that you can send packets with the ping command.
Heavily loaded user space (resulting in misinterpreted heartbeat time-out)	Run the following command in advance to extend the heartbeat time-out when running an application that can make the OS heavily loaded for a long time.  # clptoratio -r 3 -t 1d  The above mentioned command triples the heartbeat time-out for 24 hours.

## When network partitioning occurs

Network partitioning indicates that all communication routes are blocked between servers. This section describes how you can check whether or not the network is partitioned and what you should do about it. The following examples assume that you have registered LAN kernel mode LAN, disk and COM for heartbeat resources in a 2-node cluster configuration.

When all heartbeat resources are normal (the network is not partitioned), the result of executing the clpstat command is:

### When you run the command on server1

```
# clpstat -n
```

```
===== HEARTBEAT RESOURCE STATUS =====
Cluster : cluster
*server0 : server1
server1 : server2

HB0 : lanhb1
HB1 : lanhb2
HB2 : lankhb1
HB3 : lankhb2
HB4 : diskhb1
HB5 : comhb1

[on server0 : Online]
HB 0 1 2 3 4 5

-----
server0 : o o o o o o
server1 : o o o o o o

[on server1 : Online]
HB 0 1 2 3 4 5

-----
server0 : o o o o o o
```

```
server1 : o o o o o o
```

**When you run the command on server2**

```
# clpstat -n
```

```
===== HEARTBEAT RESOURCE STATUS =====
Cluster : cluster
server0 : server1
*server1 : server2

HB0 : lanhb1
HB1 : lanhb2
HB2 : lankhb1
HB3 : lankhb2
HB4 : diskhb1
HB5 : comhb1

[on server0 : Online]
  HB  0  1  2  3  4  5
-----
server0 : o o o o o o
server1 : o o o o o o

[on server1 : Online]
  HB  0  1  2  3  4  5
-----
server0 : o o o o o o
server1 : o o o o o o

=====
```

When the network is partitioned, the result of executing the clpstat command is what is described below. Both servers recognize each other that the counterpart is down.

**When you run the command on server1**

```
# clpstat -n
```

```
===== HEARTBEAT RESOURCE STATUS =====
Cluster : cluster
*server0 : server1
server1 : server2

HB0 : lanhb1
HB1 : lanhb2
HB2 : lankhb1
HB3 : lankhb2
HB4 : diskhb1
HB5 : comhb1

[on server0 : Caution]
  HB  0  1  2  3  4  5
-----
server0 : o o o o o o
server1 : x x x x x x
```

```
[on server1 : Offline]
  HB  0  1  2  3  4  5
```

```
-----
server0 : - - - - -
server1 : - - - - -
=====
```

**When you run the command on server2**

```
# clpstat -n
```

```
===== HEARTBEAT RESOURCE STATUS =====
Cluster : cluster
server0  : server1
*server1 : server2

HB0 : lanhb1
HB1 : lanhb2
HB2 : lankhb1
HB3 : lankhb2
HB4 : diskhb1
HB5 : comhb1
```

```
[on server0 : Caution]
  HB  0  1  2  3  4  5
```

```
-----
server0 : - - - - -
server1 : - - - - -
```

```
[on server1 : Online]
  HB  0  1  2  3  4  5
```

```
-----
server0 : x x x x x x
server1 : o o o o o o
=====
```

Shut down both servers immediately if the network is partitioned. Check the following for heartbeat resources.

1. LAN heartbeat resource
  - LAN cable status
  - Network interface status
2. Kernel mode LAN heartbeat resource
  - LAN cable status
  - Network interface status
3. Disk heartbeat resource
  - Disk cable status
  - Disk device status
4. COM heartbeat resource
  - COM cable status

If interconnection LAN is recovered from the network partitioning, EXPRESSCLUSTER causes the servers to shut down.

If EXPRESSCLUSTER detects that the same group is active on multiple servers, it causes the servers to shut down.

For the replicator, depending on the server shutdown timing, the statuses of mirror disk resources may not be the same after rebooting the server.

Depending on the timing of server shutdown, the status of mirror disk resources may be the one requiring forced mirror recovery, mirror recovery, or normal.

## When all interconnection LANs are disconnected

This section describes how to check the status when all interconnections (LAN heartbeat resources, kernel mode LAN heartbeat resources) between the servers are disconnected. The following examples assume that you have registered LAN, disk and COM for heartbeat resources in a 2-node cluster configuration. (You cannot register disks for the replicator.)

The following shows that the results of executing the `clpstat` command when all interconnections are disconnected and the disk and COM are normal. Both servers recognize that the other server is running.

### When you run the command on server1

```
# clpstat -n
```

```
===== HEARTBEAT RESOURCE STATUS =====
Cluster : cluster
*server0 : server1
server1 : server2

HB0 : lanhb1
HB1 : lanhb2
HB2 : lankhb1
HB3 : lankhb2
HB4 : diskhb1
HB5 : comhb1

[on server0 : Warning]
  HB  0  1  2  3  4  5
-----
server0 : o  o  o  o  o  o
server1 : x  x  x  x  o  o

[on server1 : Warning]
  HB  0  1  2  3  4  5
-----
server0 : -  -  -  -  -  -
server1 : -  -  -  -  -  -

=====
```

### When you run the command on server2

```
# clpstat -n
```

```
===== HEARTBEAT RESOURCE STATUS =====
Cluster : cluster
server0 : server1
*server1 : server2

HB0 : lanhb1
HB1 : lanhb2
HB2 : lankhb1
HB3 : lankhb2
```

```
HB4 : diskhb1
HB5 : comhb1
```

```
[on server0 : Warning]
  HB  0  1  2  3  4  5
```

```
-----
server0 : - - - - -
server1 : - - - - -
```

```
[on server1 : Warning]
  HB  0  1  2  3  4  5
```

```
-----
server0 : x x x x o o
server1 : o o o o o o
=====
```

A failover does not occur when all interconnections are disconnected like the example above because communication can be achieved by disk heartbeats and COM heartbeats.

However, interconnections must be recovered as soon as possible because commands communicated by interconnections become unavailable.

Check the following for heartbeat resources:

- 1 LAN heartbeat resources
  - LAN cable status
  - Network interface status
- 2 Kernel mode LAN heartbeat resources
  - LAN cable status
  - Network interface status

When interconnects are also used as mirror disk connect in the replicator, a mirror break occurs if the interconnections (mirror disconnects) are disconnected. Run mirror recovery after restoring the interconnections.

## Unavailable commands when interconnections are disconnected

Commands for cluster construction		
Command	Description	Remarks
clpcfctrl	Distributes the configuration information created by the Builder to the servers registered in the configuration information. Backs up the cluster configuration information to be used by the Builder.	The configuration information cannot be distributed to other servers.
clplnsc	Registers and displays the licenses of the product and trial versions of this product.	The license cannot be distributed to other servers.
Commands for showing status		
Command	Description	Remarks
clpstat	Displays the cluster status and settings information.	Statuses of other servers cannot be retrieved.
Commands for cluster operation		
Command	Description	Remarks
clpcl	Starts, stops, suspends and resumes the EXPRESSCLUSTER daemon.	Other servers cannot be operated, suspended or resumed.
clpdown	Stops the EXPRESSCLUSTER daemon and shuts down a server registered in the configuration information.	Other servers cannot be operated.
clpstdn	Stops the EXPRESSCLUSTER daemon in the entire cluster, and shuts down all servers.	Other servers cannot be operated.
clpgrp	Starts, stops, and moves groups. This command also migrates the virtual machine.	Only groups on the local server can be stopped.
clprsc	Starts, stops and moves resources.	Resources of other servers cannot be operated.
clptoratio	Extends and displays time-out values of all servers in the cluster.	Time-out ratios of other servers cannot be set.
clprexec	Issues a request to execute the error correction action from the external monitor.	Some error correction actions cannot be executed on the local server.
Commands for logs		
Command	Description	Remarks
clplogcc	Collects logs and OS information.	Logs of other servers cannot be collected.
Commands for mirror (only for the Replicator)		
Command	Description	Remarks
clpmdstat	Displays the status and settings information of mirroring	The mirror status of the remote server cannot be retrieved.
clpmdctrl	Activates/inactivates mirror disk resources and recovers mirroring. Displays/changes the settings of the maximum number of request queues.	Do not use this command. because mirror disk resources of both servers may be activated.



Commands for hybrid disk (only for the Replicator DR)		
Command	Description	Remarks
clphdstat	Displays the status and settings information of hybrid disk resource.	The status of the remote server cannot be retrieved.
clphdctrl	Activates/inactivates mirror disk resources and recovers mirroring. Displays/changes the settings of the maximum number of request queues.	Do not use this command because hybrid disk resources of both servers may be activated.
clpledctrl	Disable or Enable chassis identify on the specified server.	The control notification of chassis identify lamp to the specified server cannot be executed.

## Mounting mirror disks manually

This section describes how to manually mount mirror disks when you cannot start EXPRESSCLUSTER due to some sort of failure.

## Normally mounting mirror disk when mirroring is available

Follow the steps below when the mirror agent (EXPRESSCLUSTER data mirror daemon) can be activated while the EXPRESSCLUSTER daemon cannot.

1. Run the following command on the server where you want to mount disks.  

```
clpmdctrl --active <mirror_disk_resource_name (Example: md1)>
```
2. The mount point of mirror disk resources becomes accessible. Written data is mirrored to the other server.

## Forcibly mounting mirror disk when mirroring is not available

Follow the steps below to save data to mirror disks when neither the EXPRESSCLUSTER daemon nor the mirror agent (EXPRESSCLUSTER data mirror daemon) can be activated.

However, the mirroring status up to the moment just before both the EXPRESSCLUSTER daemon and EXPRESSCLUSTER data mirror daemon became unable to be activated must be normal, or you must know which server has the latest data.

1. Run the `chkconfig` command in the following order to set EXPRESSCLUSTER services not to start.

```
chkconfig --del clusterpro_alertsync
chkconfig --del clusterpro_webmgr
chkconfig --del clusterpro
chkconfig --del clusterpro_md
chkconfig --del clusterpro_trn
chkconfig --del clusterpro_evt
```

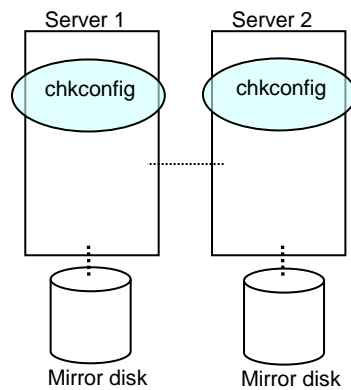
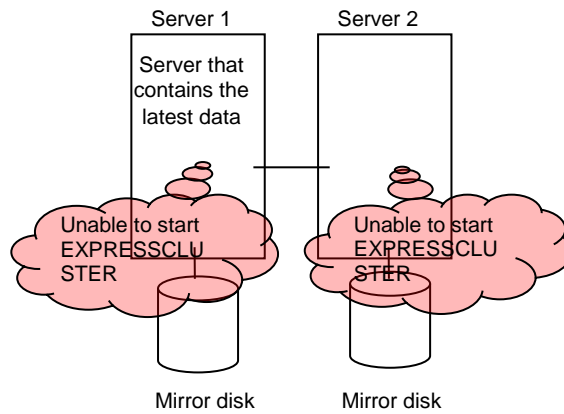

- Run the reboot command to restart the server that has the latest data or that activated the mirror disk resources last time. Shut down the other server with the shutdown command.

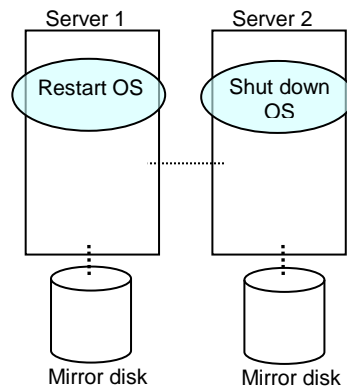

- Run the mount command to mount a data partition on a mirror disk in the read-only mode.

**(Example)** `mount -r -t ext3 /dev/sdb5 /mnt`

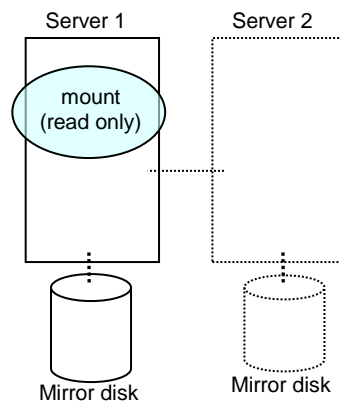

4. Back up the data in the data partition on a DAT tape or other media.

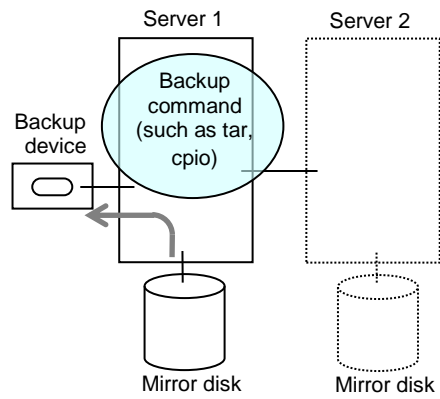

5. Unmount the mounted data partition.

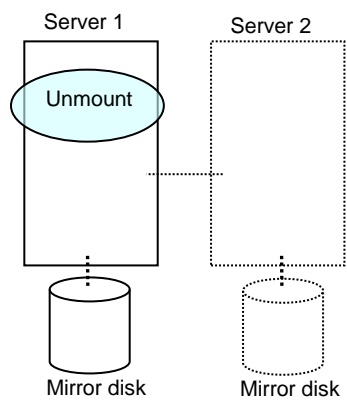

## Mounting hybrid disks manually

This section describes how to manually mount hybrid disks when you cannot start EXPRESSCLUSTER due to a failure or any other reasons.

## Normally mounting mirror disk when mirroring is available

Follow the steps below when the mirror agent (EXPRESSCLUSTER data mirror daemon) can be activated while the EXPRESSCLUSTER daemon cannot.

1. Run the following command on the server where you want to a mount disk.  

```
clphdctrl --active <hybrid_disk_resource_name (Example: hd1)>
```
2. The mount point of hybrid disk resource becomes accessible. Written data is mirrored to the other server group.

## Forcibly mounting mirror disk when mirroring is not available

Follow the steps below to save data to hybrid disks when neither the EXPRESSCLUSTER daemon nor the mirror agent (EXPRESSCLUSTER data mirror daemon) can be activated.

This can be performed provided the mirroring status up to the moment just before both the EXPRESSCLUSTER daemon and EXPRESSCLUSTER data mirror daemon became unable to be activated was normal, or you know which server has the latest data.

1. Run the `chkconfig` command in the following order to set EXPRESSCLUSTER services not to start.

```
chkconfig --del clusterpro_alertsync
chkconfig --del clusterpro_webmgr
chkconfig --del clusterpro
chkconfig --del clusterpro_md
chkconfig --del clusterpro_trn
chkconfig --del clusterpro_evt
```

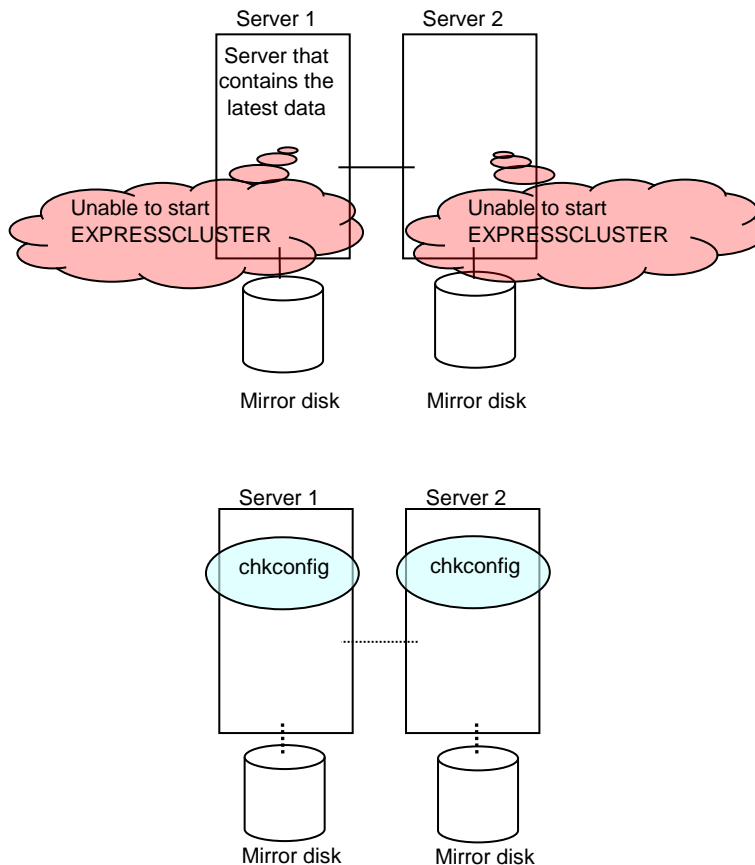

2. Run the reboot command to restart the server that has the latest data or that activated the hybrid disk resources last time. Shut down other servers with the shutdown command.

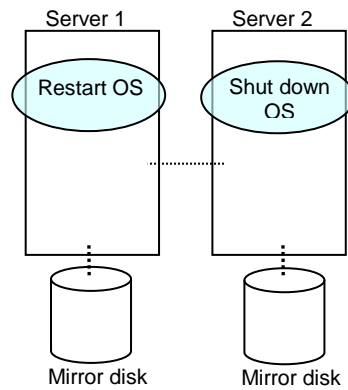

3. Run the mount command to mount the data partition on the hybrid disk in the read-only mode.

**(Example)** `mount -r -t ext3 /dev/sdb5 /mnt`

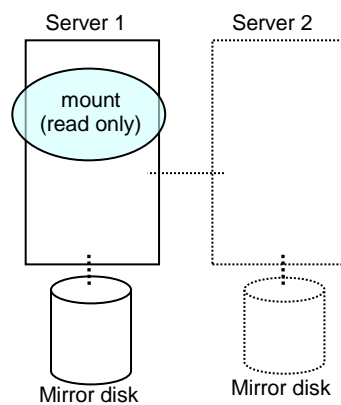

4. Back up the data in the data partition on a DAT tape or other medium.

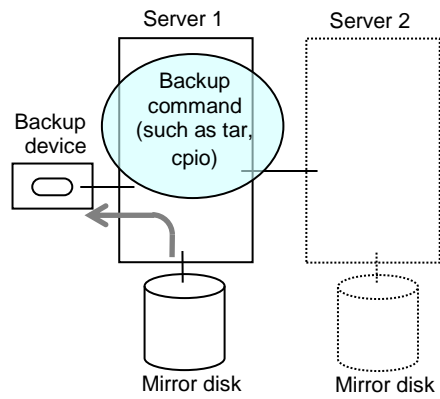

5. Unmount the mounted data partition.

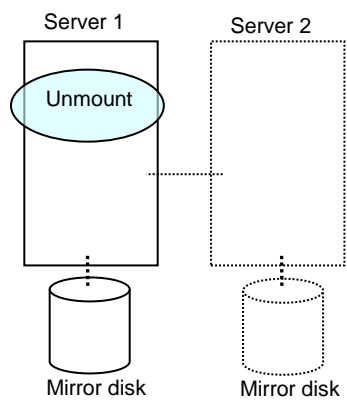



## Manually running mkfs to mirror disk or hybrid disk

To recreate the file system of a mirror partition without changing the cluster or mirror configuration, follow the steps below:

1. Confirm that the cluster is in the normal status.
2. If you need to back up the data, see “Backup procedures” and “Restoration procedures” in Chapter 8, “Verifying operation” in the *Installation and Configuration Guide* for the procedure.
3. Stop the group which has the mirror disk resources that you want to run the mkfs command.
4. Run the following command on the server where you will run mkfs.

For mirror disk:

```
clpmdctrl --active -nomount <mirror_disk_resource_name
(Example: md1)>
```

For hybrid disk:

```
clphdctrl --active -nomount <hybrid_disk_resource_name
(Example: hd1)>
```

5. Run the mkfs command to configure a file system.  
Because disks are mirrored, the mkfs command is also run on the other server.  
**(Example)** `mkfs -t ext3 <mirror_partition_device_name (Example: /dev/NMP1)>`
6. If you need to restore the backup data, see “Backup procedures” or “Restoration procedures” in Chapter 8, “Verifying operation” in the *Installation and Configuration Guide* for the procedure.
7. After confirming the completion of the file system creation, run the following command:

For mirror disk:

```
clpmdctrl --deactive <mirror_disk_resource_name (Example:
md1)>
```

For mirror disk:

```
clphdctrl --deactive <hybrid_disk_resource_name (Example: md1)>
```

## Recovering from mirror breaks

When the auto-mirror recovery is enabled, no special operation is required. Mirroring is automatically recovered. However, if mirroring needs to be recovered forcibly, execution of a command or operations for forcible mirror recovery using the WebManager are required.

The difference mirror recovery function is disabled in the forcible mirror recovery and the data is fully copied. If the auto-mirror recovery is disabled, you have to recover mirroring by executing a command or using the WebManager.

## Automatically recovering from mirroring

When the auto-mirror recovery is enabled, mirroring is recovered under the following conditions:

1. Mirror disk resources or hybrid disk resources are active.
2. The server where mirror disk resources or hybrid disk resources are active contains the latest data.
3. Servers in the cluster are in the normal status, and you can verify their mirroring statuses.
4. The data among the servers is not the same.

The auto-mirror recovery is not performed if any of the following applies.

1. One of the servers is not started.
2. You cannot confirm the mirroring status of the other server.  
(For example, communication is impossible or the cluster of the other server stops.)
3. There is no server whose mirror status is normal.
4. The mirror status is pending (hybrid disk resources only)
5. Mirror synchronization is stopped manually.  
(For example, synchronization is stopped by executing the `--break` option with the `clpmdctrl` or `clphdctrl` command, or the GREEN-GREEN status is changed to the GREEN-RED status by the WebManager Mirror Disk Helper. This excludes, however, the case in which the server is restarted after synchronization stops or in which synchronization is started manually.)
6. The mirror disk monitor resource and hybrid disk monitor resource stopped.  
(For example, the relevant monitor resource is temporarily stopped by the `clpmonctrl` command or WebManager.)

For information on how to verify the progress of recovering mirroring, see “Checking the mirror recovery progress with a command” on page 1392 and “Checking the mirror recovery progress from the WebManager” on page 1401.

## Checking the mirror break status with a command

Run the following command to view the mirror break statuses.

For mirror disk:

```
clpmdstat --mirror <mirror_disk_resource_name (Example: md1)>
```

For hybrid disk:

```
clphdstat --mirror <hybrid_disk_resource_name (Example: hd1)>
```

You can view the statuses of mirror disk resource or hybrid disk resource by running the `clpmdstat` command or `clphdstat` command.

1. When normal:

```
Mirror Status: Normal
```

```
md1                server1                server2
-----
Mirror Color        GREEN                GREEN
```

**2. When the mirror recovery is required:**

Mirror Status: Error

Total Difference: 1%

mdl	server1	server2
Mirror Color	GREEN	RED
Lastupdate Time	2004/03/04 17:30:05	--
Break Time	2004/03/04 17:30:05	--
Disk Error	OK	OK
Difference Percent	1%	--

**3. When the forcible mirror recovery is required:**

Mirror Status: Error

Total Difference: 1%

mdl	server1	server2
Mirror Color	RED	RED
Lastupdate Time	2004/03/09 14:07:10	2004/03/09 13:41:34
Break Time	2004/03/09 14:06:21	2004/03/09 13:41:34
Disk Error	OK	OK
Difference Percent	1%	1%

**4. While the mirroring is being recovered:**

See “Checking the mirror recovery progress with a command” on page 1392.

## Checking the mirror recovery progress with a command

Run the following command to view the progress of recovering mirroring.

For mirror disk:

```
clpmdstat --mirror <mirror_disk_resource_name (Example: md1)>
```

For hybrid disk:

```
clphdstat --mirror <hybrid_disk_resource_name (Example: hd1)>
```

You will see the following data while mirroring is being recovered.

```
Mirror Status: Recovering

md1                server1                server2
-----
Mirror Color        YELLOW                 YELLOW

Recovery Status    Value
-----
Status:             Recovering
Direction:          server1 -> server2
Percent:            7%
Used Time:          00:00:09
Remain Time:        00:01:59
```

You will see the following information when the mirror recovery is successfully completed.

```
Mirror Status: Normal

md1                server1                server2
-----
Mirror Color        GREEN                  GREEN
```

## Recovering mirror with a command

Run the following command to start the mirror recovery.

For mirror disk:

```
clpmdctrl --recovery <mirror_disk_resource_name (Example: md1)>
```

For hybrid disk:

```
clphdctrl --recovery <hybrid_disk_resource_name (Example: hd1)>
```

When FastSync Option is enabled, only the difference data is recovered. Therefore, the mirror recovery takes less time than when FastSync Option is disabled(FastSync technology).

This command immediately returns the control once the mirror recovery starts. For information on how to verify the mirror recovery progress, see “Checking the mirror recovery progress with a command” on page 1392 and “Checking the mirror recovery progress from the WebManager” on page 1401.

## Running the forcible mirror recovery with a command

If EXPRESSCLUSTER cannot determine which server contains the latest data, you have to run the forcible mirror recovery.

In this case, you have to manually identify the server that holds the latest data, and perform the forcible mirror recovery.

Identify the server that holds the latest data by any of the following means:

- Using Mirror Disk Helper of the WebManager
  1. Right-click **Servers** in the WebManager tree to start Mirror Disk Helper.
  2. On the main screen of Mirror Disk Helper, display the detailed data of the mirror disk resources you want to see.
  3. Click **Details**.
  4. See the last update time stamp (Last Data Updated Time) to identify the server which has the latest data. However, this Last Data Updated Time depends on the operating system's clock.

Note that, for X3.1.3-1 and older versions, if the group and mirror are already active and the mirrors of both servers are RED, the server on which the group and mirror are already active should be identified as having the latest data. (For example, if one server is running alone with its mirror normally active and then the other server is started, resulting in the mirror disks of both servers becoming RED at the same time, identify the server for which the mirror is already active as having the latest data.) At this time, if the inactive mirror of the other server contains data that you need to access, access that data only after releasing the access control by using Mirror Disk Helper or after executing forcible activation by using the `clpmdctrl` or `clphdctrl` command with the `--active -force -ro` option specified. After accessing the data, restore the access control state by using Mirror Disk Helper or the `clpmdctrl` or `clphdctrl` command with the `--deactive` option specified.

- Using the `clpmdstat` or `clphdstat` command

Confirmation method is the same as Mirror Disk Helper of the WebManager except that you use a command.

1. Run the following command.

For mirror disk:

```
clpmdstat --mirror <mirror_disk_resource_name (Example: md1)>
```

For hybrid disk:

```
clphdstat --mirror <hybrid_disk_resource_name (Example: hd1)>
```

2. See the last update time stamp (Last Data Updated Time) to identify the server which has the latest data. However, this Last Data Updated Time depends on the operating system's clock.

Note that, for X3.1.3-1 and older versions, if the group and mirror are already active and the mirrors of both servers are RED, the server on which the group and mirror are already active should be identified as having the latest data. (For example, if one server is running alone with its mirror normally active and then the other server is started, resulting in the mirror disks of both servers becoming RED at the same time, identify the server for which the mirror is already active as having the latest data.) At this time, if the inactive mirror of the other server contains data that you need to access, access that data only after releasing the access control by using Mirror Disk Helper or after executing forcible activation by using the `clpmdctrl` or `clphdctrl` command with the `--active -force -ro` option specified. After accessing the data, restore the access control state by using Mirror Disk Helper or the `clpmdctrl` or `clphdctrl` command with the `--deactive` option specified

- Using data on mirror disks

This method is not recommended because the data may be corrupted if anything goes wrong in the procedure. Perform the following steps on both servers to identify which has the latest data.

1. Confirm all groups are stopped.
2. Mount the data partition in the read only mode by referring to "Forcibly mounting mirror disk when mirroring is not available" on page 1382.
3. Logically examine the data on the mount point.
4. Unmount the data partition.

Identify the server that holds the latest data and then start forcible mirror recovery by any of the following means:

- Method (1) Using full-scale copy while the group is active

Forcible mirror recovery by this method disables the difference mirror recovery function and instead uses full-scale copy.

The entire area is copied regardless of the amount of disk space that is used, so it will take a considerable time for copy to complete if the disk size is large or the communication speed is low. (for between X3.0.0-1 and X3.1.7-2)

If the group stops during forcible mirror recovery, you cannot start the group until forcible mirror recovery is completed. Once forcible mirror recovery completion has been confirmed, the mirror disk can be used by starting the group.

If full-scale copy is performed while the group is active, the system load may be high because forcible mirror recovery must be performed while the group is active.

If the group contains two or more mirror disk resources or hybrid disk resources, these resources must all contain the latest data *on the same server*.

1. Execute the `clpmdctrl` or `clphdctrl` command to start full-scale copy.  
 (For X3.1.8-1 or later, specify the name of the server containing the latest data and the resource name for command arguments.)  
 (For X3.0.0-1 to X3.1.7-2, specify the `-v` option, the name of the server containing the latest data, and the resource name for the command argument.)

For mirror disk: (for X3.1.8-1 or later)

```
clpmdctrl --force <server_containing_the_latest_data>  
<mirror_disk_resource_name (Example: md1)>
```

For hybrid disk: (for X3.1.8-1 or later)

```
clphdctrl --force <server_containing_the_latest_data>  
<hybrid_disk_resource_name (Example: hd1)>
```

For mirror disk: (for between X3.0.0-1 and X3.1.7-2)

```
clpmdctrl -force -v <server_containing_the_latest_data>  
<mirror_disk_resource_name (Example: md1)>
```

For hybrid disk: (for between X3.0.0-1 and X3.1.7-2)

```
clphdctrl -force -v <server_containing_the_latest_data>  
<hybrid_disk_resource_name (Example: hd1)>
```

2. When mirror recovery is started by the command, the command returns control immediately. Confirm the mirror recovery status and then wait for mirror recovery to complete.
3. When the group is not active, after confirming the completion of mirror recovery, start the group.

- Method (2) Performing full copy while the group is active

With forcible mirror recovery using this method, the difference mirror recovery function is disabled, and full copy is performed instead.

Depending on the file system type, disk usage, and load status, this takes less copying time than the procedures of methods (1) and (3), which are performed in the active state.

Perform this method while the group is stopped. Until forcible mirror recovery is completed, you cannot start the group. Once forcible mirror recovery completion has been confirmed, the mirror disk can be used by starting the group.

If the group contains two or more mirror disk resources or hybrid disk resources, these resources all need to contain the latest data *on the same server*.

1. If the group is active, stop the group.
2. Execute the `clpmdctrl` or `clphdctrl` command to start full-scale copy.  
 (Specify the latest data holding server name and resource name in the command argument.)

For mirror disk

```
clpmdctrl --force <server_containing_the_latest_data>  
<mirror_disk_resource_name (Example: md1)>
```

For hybrid disk

```
clphdctrl --force <server_containing_the_latest_data>  
<hybrid_disk_resource_name (Example: hd1)>
```

3. When mirror recovery is started by the command, the command returns control immediately. Confirm the mirror recovery status and then wait for mirror recovery to complete.

4. After confirming the completion of mirror recovery, start the group.

- Method (3) Performing full copy by changing the group from the deactivated state to the active state

With forcible mirror recovery using this method, the difference mirror recovery function is disabled, and full copy is performed instead.

As with method (1), the entire area is copied regardless of the amount of disk space that is used, so it will take a considerable time until copy completion if the disk size is large or the communication speed is low. (for between X3.0.0-1 and X3.1.7-2)

If the group is stopped during forcible mirror recovery, the group cannot be started until forcible mirror recovery is complete. In such a case, once forcible mirror recovery completion has been confirmed, the mirror disk can be used by starting the group.

Note that, because forcible mirror recovery is performed concurrently while the group is active, the system load may be high.

If the group contains two or more mirror disk or hybrid disk resources, these resources must all contain the latest data *on the same server*.

1. While the group is not active, suspend the mirror disk monitor resource or the hybrid disk monitor resource being used to monitor a mirror disk resource or a hybrid disk resource. On each server, execute the command below.

This causes auto-mirror recovery to be temporarily unavailable.

```
clpmonctrl -s -m<relevant_monitor_resource_name (example: mdw1)>
```

(To suspend a monitor resource by using WebManager instead of the command, right-click the relevant mirror disk monitor resource or hybrid disk monitor resource in the WebManager tree view, and then execute **Suspend**. In the confirmation window that appears on the target server, select **OK**. The monitor will enter the “suspended” state.)

2. **On the server holding the latest data**, execute the clpmdctrl or clphdctrl command to change the mirror disk status of the relevant server to the latest status. (Do not specify the latest data holding server name in the command argument.)

For mirror disk

```
clpmdctrl --force <mirror_disk_resource_name (Example: md1)>
```

For hybrid disk

```
clphdctrl --force <hybrid_disk_resource_name (Example: hd1)>
```

3. Confirm that the relevant mirror disk resource and hybrid disk resource have entered the latest status (GREEN) by using the WebManager Mirror Disk Helper, clpmdstat command, or clphdstat command.

After confirming the status, start the relevant group **on the server holding the latest data** using the clpgrp command or WebManager.

4. Upon the completion of group start, execute the clpmdctrl or clphdctrl command to start full copy.

(For X3.1.8-1 or later, specify the name of the server containing the latest data and the resource name for command arguments.)

(For X3.0.0-1 to X3.1.7-2, specify the -v option, the name of the server containing the latest data, and the resource name for the command argument.)

For mirror disk : (for X3.1.8-1 or later)

```
clpmdctrl --force <server_containing_the_latest_data> <mirror_disk_resource_name (Example: md1)>
```

For hybrid disk : (for X3.1.8-1 or later)



```
clphdctrl --force <server_containing_the_latest_data>
<hybrid_disk_resource_name (Example: hd1)>
```

For mirror disk : (for X3.0.0-1 to X3.1.7-2)

```
clpmdctrl --force <server_containing_the_latest_data>
<mirror_disk_resource_name (Example: mdl)>
```

For hybrid disk : (for X3.0.0-1 to X3.1.7-2)

```
clphdctrl --force <server_containing_the_latest_data>
<hybrid_disk_resource_name (Example: hd1)>
```

5. When you start mirror recovery with the command, the command will return control immediately.  
Then, return the suspended monitor resource to its original state.  
On each server, execute the following command.

```
clpmonctrl -s -m <relevant_monitor_resource_name (example:
mdl)>
```

(To resume a monitor resource by using WebManager instead of the command, right-click the relevant mirror disk monitor resource or hybrid disk monitor resource in the WebManager tree view, and then execute **Resume**. In the confirmation window that appears on the target server, select **OK**. The monitor will enter the “resume” state.)

- Method (4) Using auto mirror recovery and difference mirror recovery

If difference mirror recovery is possible, perform recovery using the difference information. Since mirror recovery is performed while the group is activated, the system load may be high.

If differential mirror recovery is impossible, and the version is earlier than X3.1.8-1, perform full copy with the procedure of the method (1), (2) or (3).

If the group contains two or more mirror disk resources or hybrid disk resources, these resources all need to hold the latest data **on the same server**.

1. By using the clpmdstat command, the clphdstat command, or Mirror Disk Helper, confirm whether difference mirror recovery is possible. (for X3.0.0-1 to X3.1.7-2 )

If confirmation is acquired by executing a command, "Diff Recovery" is displayed as "Enable" if difference mirror recovery is possible, as shown below.

If "Enable" is not displayed, and the version is earlier than X3.1.8-1, perform full copy with the procedure of the method (1), (2) or (3).

For mirror disk

```
clpmdstat --detail <mirror_disk_resource_name (Example:
mdl)>
```

For hybrid disk

```
clphdstat --detail <hybrid_disk_resource_name (Example:
hd1)>
```

<<Command execution result display example>>

Mirror Disk Name	: mdl
Sync Switch	: On
Sync Mode	: Sync
Diff Recovery	: <b>Enable</b>

(To confirm whether difference mirror recovery is possible, using Mirror Disk Helper, click the **Details** button in the dialog box of Mirror Disk Helper to display the details. If the value of “Difference copy” is “Possible” on both servers, difference mirror recovery is possible. Otherwise, perform full copy with the procedure of the method (1), (2) or (3).)

2. **On the server holding the latest data**, execute the `clpmdctrl` or `clphdctrl` command to change the mirror disk status of the relevant server to the latest status.  
(Do not specify the latest data holding server name in the command argument.)

For mirror disk

```
clpmdctrl --force <mirror_disk_resource_name (Example: md1)>
```

For hybrid disk

```
clphdctrl --force <hybrid_disk_resource_name (Example: hd1)>
```

3. When the group is not active, confirm that the relevant mirror disk resource and hybrid disk resource have entered the latest status (GREEN) by using the WebManager Mirror Disk Helper, `clpmdstat` command, or `clphdstat` command.

After confirming the status, start the relevant group **on the server holding the latest data** using the `clgrp` command or WebManager.

4. When the group is not active, auto mirror recovery starts after the relevant group starts (after activation).

When the group is active, auto mirror recovery starts after the operation in 1.

If auto mirror recovery is not started because, for example, **Auto Mirror Recovery** is cleared, use the `clpmdctrl` or `clphdctrl` command or Mirror Disk Helper to start mirror recovery manually.

For mirror disk

```
clpmdctrl --recovery <mirror_disk_resource_name (Example: md1)>
```

For hybrid disk

```
clphdctrl --recovery <hybrid_disk_resource_name (Example: hd1)>
```

The `clpmdctrl` or `clphdctrl` command immediately returns control once mirror recovery starts. For information on how to check the mirror recovery progress, see “Checking the mirror recovery progress with a command” on page 1392 and “Checking the mirror recovery progress from the WebManager” on page 1401.

## Running the forcible mirror recovery with a command only on one server

In some cases, you cannot start one of the servers due to a hardware or OS failure, and the server that can be started may not have the latest data. If you want to start applications at least on the server that can be started, you can perform the forcible mirror recovery on that server.

However, remember that if you do this, the data on the server where you run this command becomes the latest data no matter which server actually has it. Therefore, even if you are able to start the other server later, you cannot handle the data in that server as the latest one. Make sure you understand the consequence before running the following command.

Run the following command to start the forcible mirror recovery:

For mirror disk:

```
clpmdctrl --force <mirror_disk_resource_name (Example: md1)>
```

For hybrid disk:

```
clphdctrl --force <hybrid_disk_resource_name (Example: hd1)>
```

After running the command, you can activate the groups and use the mirror disks or hybrid disks.

## Checking the mirror break status from the WebManager

You can see the mirror break status by starting Mirror Disk Helper from the WebManager. (The following is an example of mirror disk resource. The color of icons, what the statuses mean and description are the same for hybrid disk resources, although the screen display is different.)

- When normal:

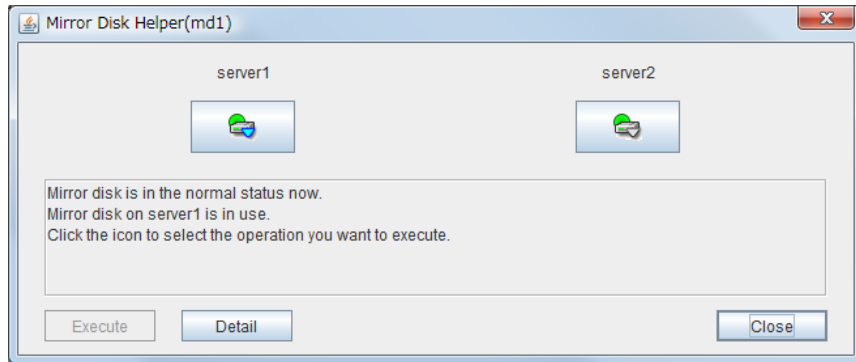

- When mirror recovery is required:

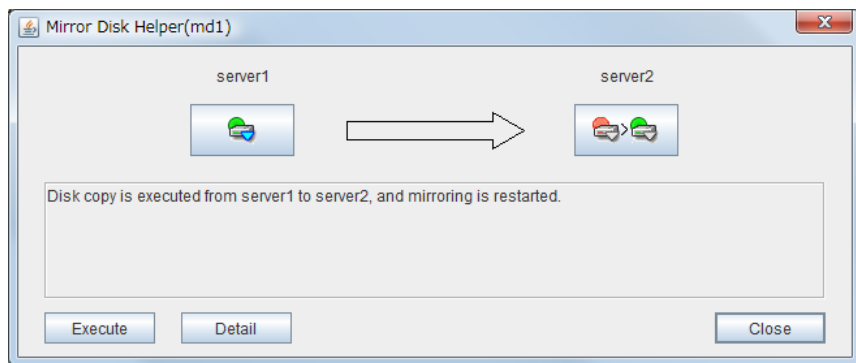

- When forcible mirror recovery is required:

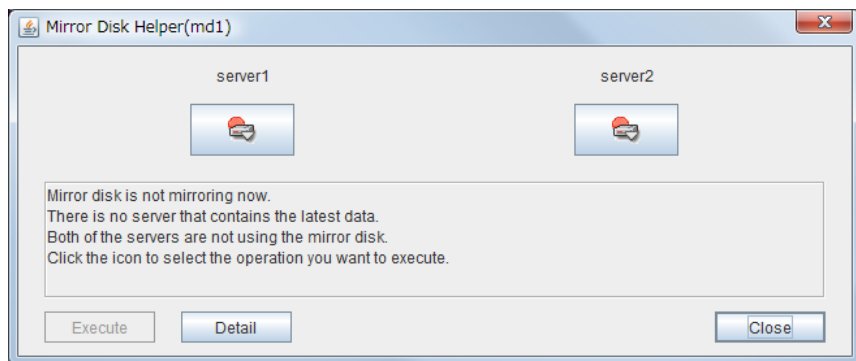

- While mirror recovery is in progress:

See “Checking the mirror recovery progress from the WebManager” on page 1401.

## Checking the mirror recovery progress from the WebManager

Start Mirror Disk Helper from the WebManager to view the mirror recovery progress. (The following is an example of mirror disk resource. The color of icons, what the statuses mean and description are the same for hybrid disk resources, although the screen display is different.)

You will see the following screen during the mirror recovery.

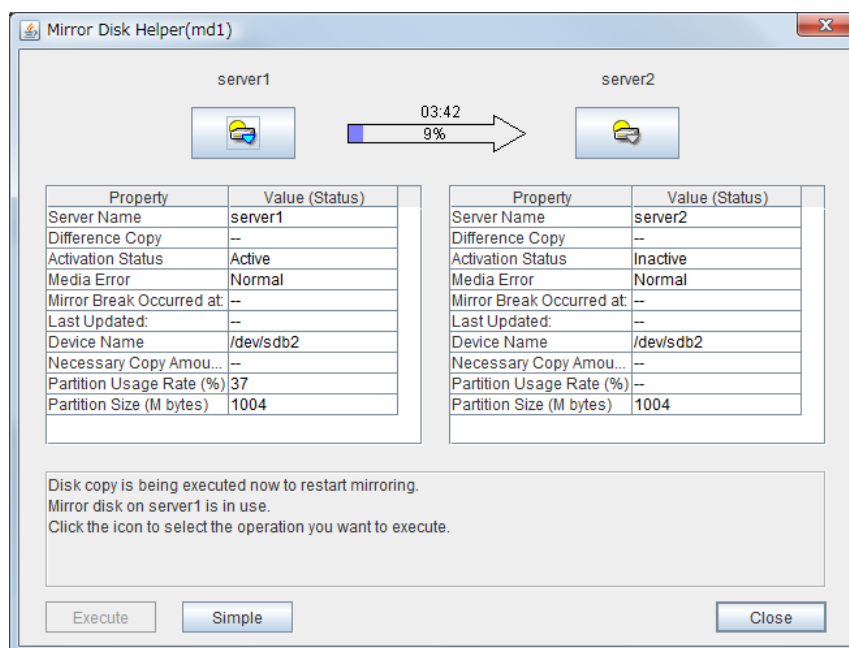

You will see the following screen when the mirror recovery is successfully completed.

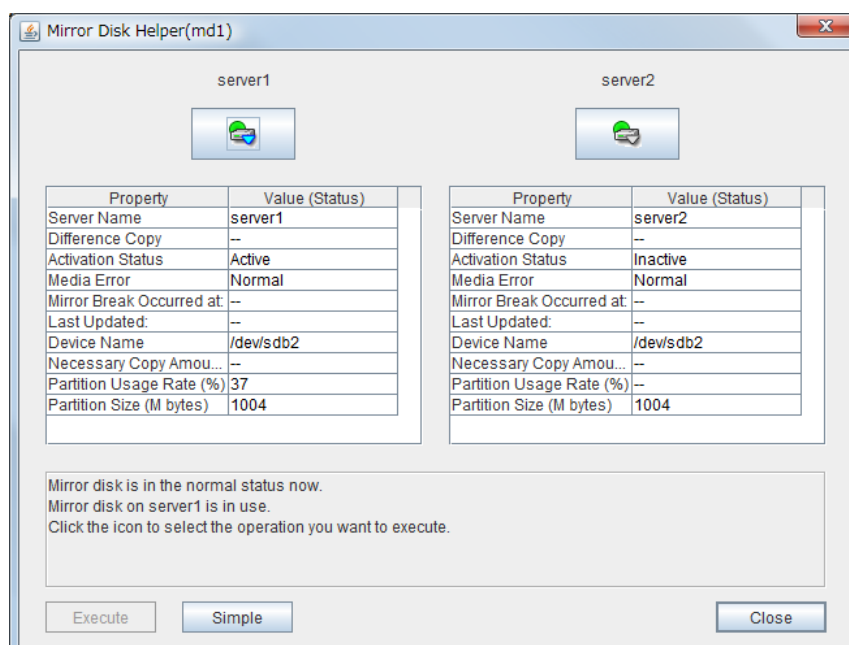

## Recovering mirror using the WebManager

Start Mirror Disk Helper from the WebManager to start mirror recovery. For information on the Mirror Disk Helper, see “Mirror disk helper” in Chapter 1, “Functions of the WebManager” in this guide.

For information on how to check the mirror recovery progress, see “Checking the mirror recovery progress with a command” on page 1392 and “Checking the mirror recovery progress from the WebManager” on page 1401.

## Running the forcible mirror recovery using the WebManager

When EXPRESSCLUSTER cannot determine which server has the latest data, you have to perform the forcible mirror recovery.

In this case, you have to manually identify the server which holds the latest data, and perform the forcible mirror recovery.

Identify the server that has the latest data by any of the following methods:

- Using Mirror Disk Helper of the WebManager
  1. Right-click **Servers** in the WebManager tree to start the Mirror Disk Helper.
  2. On the main screen of Mirror Disk Helper, display the detailed data of the mirror disk resources you want to see.
  3. Click **Details**.
  4. See the last update time stamp (Last Data Updated Time) to identify the server which has the latest data. However, this Last Data Updated Time depends on the operating system’s clock.

Note that, for X3.1.3-1 and older versions, if the group and mirror are already active and the mirrors of both servers are RED, the server on which the group and mirror are already active should be identified as having the latest data. (For example, if one server is running alone with its mirror normally active and then the other server is started, resulting in the mirror disks of both servers becoming RED at the same time, identify the server for which the mirror is already active as having the latest data.) At this time, if the inactive mirror of the other server contains data that you need to access, access that data only after releasing the access control by using Mirror Disk Helper or after executing forcible activation by using the `clpmdctrl` or `clphdctrl` command with the `--active -force -ro` option specified. After accessing the data, restore the access control state by using Mirror Disk Helper or the `clpmdctrl` or `clphdctrl` command with the `--deactive` option specified
- Using the `clpmdstat` command or `clphdstat` command

Confirm method is the same as Mirror Disk Helper of the WebManager except that you use a command.

1. Run the following command:

For mirror disk:

```
clpmdstat --mirror <mirror_disk_resource_name (Example: md1)>
```

For hybrid disk:

```
clphdstat --mirror <hybrid_disk_resource_name (Example: hd1)>
```

2. See the last update time stamp (Last Data Updated Time) to identify the server which contains the latest data. However, this Last Data Updated Time depends on the

operating system's clock.

Note that, for X3.1.3-1 and older versions, if the group and mirror are already active and the mirrors of both servers are RED, the server on which the group and mirror are already active should be identified as having the latest data. (For example, if one server is running alone with its mirror normally active and then the other server is started, resulting in the mirror disks of both servers becoming RED at the same time, identify the server for which the mirror is already active as having the latest data.) At this time, if the inactive mirror of the other server contains data that you need to access, access that data only after releasing the access control by using Mirror Disk Helper or after executing forcible activation by using the `clpmdctrl` or `clphdctrl` command with the `--active -force -ro` option specified. After accessing the data, restore the access control state by using Mirror Disk Helper or the `clpmdctrl` or `clphdctrl` command with the `--deactive` option specified

- Using data on mirror disks

This is not recommended because the data may be corrupted destroyed if anything goes wrong in the procedure.

Perform the following steps on both servers to identify which has the latest data.

1. Confirm that all groups are inactive.
2. See “Forcibly mounting mirror disk when mirroring is not available” on page 1382.
3. Logically examine the data on the mount point.
4. Unmount the data partition.

When you have identified the server containing the latest data, start the Mirror Disk Helper from the WebManager to start the forcible mirror recovery. For information on the Mirror Disk Helper, see “Mirror disk helper” in Chapter 1, “Functions of the WebManager” in this guide.

Start forcible mirror recovery using any of the following methods:

- Method (1) Using full-scale copy

Forcible mirror recovery by this method disables the difference mirror recovery function and instead uses full-scale copy.

Note that the group cannot be started until forcible mirror recovery is complete. Once forcible mirror recovery completion has been confirmed, the mirror disk can be used by starting the group.

1. Using the Mirror Disk Helper, execute full copy from the server holding the latest data to the copy destination server and then start mirror recovery.  
(When the group has already been started, full copy cannot be selected by the Mirror Disk Helper. In this case, stop the group, or perform forcible mirror recovery with the relevant command.)
2. After confirming the completion of mirror recovery, start the group.

- Method (2) Using auto mirror recovery and difference mirror recovery

If difference mirror recovery is possible, perform recovery using the difference information. The mirror recovery takes less time than when the forcible mirror recovery is performed (FastSync technology).

Because mirror recovery is performed while the group is activated, the system load may be high.

If difference mirror recovery is impossible, and the version is earlier than X3.1.8-1, perform full copy with the procedure of the method (1).

If the group contains two or more mirror disk resources or hybrid disk resources, these resources all need to hold the latest data **on the same server**.

1. By using Mirror Disk Helper, the `clpmdstat` command, or the `clphdstat` command, confirm whether difference mirror recovery is possible. (for X3.0.0-1 to X3.1.7-2)
2. An attempt to Using the Mirror Disk Helper, change the mirror disk status of **the server holding the latest data** from RED to GREEN.  
(When the group has already been started, this operation cannot be executed by the Mirror Disk Helper. In this case, stop the group, or perform forcible mirror recovery with the relevant command.)
3. Confirm that the relevant mirror disk resource and hybrid disk resource have entered the latest status (GREEN).  
After confirming the status, start the relevant group **on the server holding the latest data**.
4. After the relevant group starts (after activation), auto mirror recovery starts.  
If difference mirror recovery is possible, it is performed.  
If difference mirror recovery is impossible, full-scale copy is performed.  
If auto mirror recovery is not started such as the auto mirror recovery is OFF, start the mirror recovery manually using the Mirror Disk Helper.

For information on how to check the forcible mirror recovery progress, see “Checking the mirror recovery progress with a command” on page 1392 and “Checking the mirror recovery progress from the WebManager” on page 1401.

## Running the forcible mirror recovery from the WebManager only on one Server

In some cases, you cannot start one of the servers due to a hardware or OS failure, and the server that can be started may not have the latest data.

If you want to start applications at least on the server that can be started, you can perform the forcible mirror recovery on that server.

However, remember that if you do this, the data on the server where you run this command becomes the latest data regardless of which server actually contains the data. Therefore, even if the other server becomes available later, you cannot handle the data in that server as the latest one. Make sure you understand the consequence before running the following command.

Start the Mirror Disk Helper from the WebManager to start the forcible mirror recovery. For information on the Mirror Disk Helper, see “Mirror disk helper” in Chapter 1, “Functions of the WebManager” in this guide.

When the forcible mirror recovery is successfully completed, you can activate the groups and use the mirror disks.



## Changing current server on hybrid disk

Conditions in which current server can be changed is as follows:

Hybrid disk status		Whether or not current server can be changed	
Server group 1	Server group 2	Server group 1	Server group 2
error/deactivated	error/deactivated	Yes	Yes
normal/deactivated	error/deactivated	Yes	Yes
error/deactivated	normal/deactivated	Yes	Yes
normal/deactivated	normal/deactivated	Yes	Yes
normal/activated	error/deactivated	No	Yes
error/deactivated	normal/activated	Yes	No
normal/activated	normal/deactivated	No	No
pending/deactivated	pending/deactivated	Yes	Yes

## Changing current server with a command

Run the following command on the server which you want to make current server to change the current server of hybrid disk.

```
clphdctrl --setcur <hybrid_disk_resource_name(Example:hd1)>
```

## Changing current server with WebManager

Start Mirror Disk Helper from WebManager. For information on the Mirror Disk Helper, see “Mirror disk helper” in Chapter 1, “Functions of the WebManager” in this guide.

## Troubleshooting problems with VERITAS volume manager

This section describes how to handle trouble when using VERITAS volume manager.

### Modifying the VERITAS volume manager configuration

Whether or not the OS needs to be restarted determines the steps for changing the VERITAS Volume Manager configuration.

- If the OS does not need to be restarted when changing the configuration, see “When the OS does not need to be restarted to change the configuration of VERITAS Volume Manager (when using the online version Builder)” or “When the OS does not need to be restarted to change the configuration of VERITAS Volume Manager (when using the offline version Builder).”
- If the OS needs to be restarted when changing the configuration, see “When restart of the OS is necessary to change the configuration of VERITAS Volume Manager.”

#### **When the OS does not need to be restarted to change the configuration of VERITAS Volume Manager (when using the online version Builder)**

1. Connect to the WebManager with a management IP address. If you do not have any management IP address, connect to it by using the actual IP address of any server.
2. From the **Service** menu on the WebManager, click **Stop Cluster**.
3. Change the configuration of VERITAS Volume Manager.
4. Start the online version Builder on the WebManager you connected to.
5. Change the settings of the resource using the Builder.
6. Upload the cluster configuration data on the Builder.
7. From the **Service** menu on the WebManager, click **Start Cluster**.

The settings will be effective.

**When the OS does not need to be restarted to change the configuration of VERITAS Volume Manager (when using the offline version Builder)**

1. Back up the cluster configuration data on a floppy disk.

Choose Step A or B depending on the type of OS that uses the Builder.

- Run the command below to make a backup of the Builder which operates on the Web browser of Linux on a floppy disk.

```
clpcfctrl --pull -l
```

- B.Run the command below to make a backup of the Builder which operates on the Web browser of Windows on a floppy disk.

```
clpcfctrl --pull -w
```

For information on troubleshooting clpcfctrl problems, see “Creating a cluster and backing up configuration data (clpcfctrl command)” in Chapter 3, “EXPRESSCLUSTER command reference” in this guide.

2. Stop the cluster.

```
clpctl -t -a
```

3. Change the configuration of VERITAS Volume Manager.

4. Change the settings of the resource using the Builder

5. Load the configuration information in the floppy disk to server. Choose Step A or B depending on the type of the floppy disk you created with the Builder.

- A.Run the command below to use the floppy disk with the information you created with the Builder for Linux.

```
clpcfctrl --push -l
```

- B.Run the command below to use the floppy disk with the information you created with the Builder for Windows (1.44 MB, formatted on Windows OS).

```
clpcfctrl --push -w
```

For information on troubleshooting clpcfctrl problems, see “Creating a cluster and backing up configuration data (clpcfctrl command)” in Chapter 3, “EXPRESSCLUSTER command reference” in this guide.

6. Remove the information floppy disk from the floppy disk drive.

The settings will be effective next time the group is activated.

**When restart of the OS is necessary to change the configuration of VERITAS Volume Manager**

1. Back up the cluster configuration data on a floppy disk. Choose Step A or B depending on the type of OS that uses the Builder.

- Run the command below to make a backup of the Builder which operates on the Web browser of Linux on a floppy disk.

```
clpcfctrl --pull -l
```

- B. Run the command below to make a backup of the Builder which operates on the Web browser of Windows on a floppy disk.

```
clpcfctrl --pull -w
```

For information on troubleshooting clpcfctrl problems, see “Creating a cluster and backing up configuration data (clpcfctrl command)” in Chapter 3, “EXPRESSCLUSTER command reference” in this guide.

2. Run the chkconfig command as shown below on all servers to stop the EXPRESSCLUSTER services from starting.

```
chkconfig --del clusterpro_alertsync  
chkconfig --del clusterpro_webmgr  
chkconfig --del clusterpro  
chkconfig --del clusterpro_md
```

3. Stop the EXPRESSCLUSTER daemon.

```
clpcl -t -a
```

4. Change the configuration of VERITAS Volume Manager, and restart the OS.

5. Change the settings of resources using the Builder.

6. Load the configuration information in the floppy disk to the server. Choose Step A or B depending on the type of the floppy disk you created with the Builder.

- A. Run the command below to use the floppy disk with the information you created with the Builder for Linux.

```
clpcfctrl --push -l
```

- B. Run the command below to use the floppy disk with the information you created with the Builder for Windows (1.44 MB format).

```
clpcfctrl --push -w
```

For information on troubleshooting clpcfctrl problems, see “Creating a cluster and backing up configuration data (clpcfctrl command)” in Chapter 3, “EXPRESSCLUSTER command reference” in this guide.

7. Remove the information floppy disk from the floppy disk drive.

8. Run the chkconfig command shown below on all servers to start the EXPRESSCLUSTER services.

```
chkconfig --add clusterpro_md  
chkconfig --add clusterpro  
chkconfig --add clusterpro_webmgr  
chkconfig --add clusterpro_alertsync
```

9. Restart all servers.

The services will be effective next time the OS is started.

## Operations of EXPRESSCLUSTER when VERITAS volume manager fails

See procedures in “To change the cluster configuration data,” if you do not wish to failover groups or the final action to take place when a problem occurs in VERITAS Volume Manager and an error is detected in the disk resource and/or VxVM volume manager resource.

See procedures in “Restoring the cluster configuration information,” if you wish to recover from a VERITAS Volume Manager error and to establish control again by using the EXPRESSCLUSTER.

### To change the cluster configuration data

1. Start all servers at run level 1.
2. Run the chkconfig command shown below on all servers to stop the EXPRESSCLUSTER services from starting.

```
chkconfig --del clusterpro_alertsync
chkconfig --del clusterpro_webmgr
chkconfig --del clusterpro
chkconfig --del clusterpro_md
```

3. Restart all servers.
4. Make a backup of the cluster configuration data on a floppy disk. Choose Step A or B depending on the type of OS that uses the Builder.
  - Run the command shown below to make a backup of the Builder which operates on the Web browser of Linux on a floppy disk.

```
clpcfctrl --pull -l
```

- B. Run the command below to make a backup of the Builder which operates on the Web browser of Windows on a floppy disk.

```
clpcfctrl --pull -w
```

For information on troubleshooting clpcfctrl problems, see “Creating a cluster and backing up configuration data (clpcfctrl command)” in Chapter 3, “EXPRESSCLUSTER command reference” in this guide.

5. In case the configuration information should be restored, make another copy of cluster configuration in a floppy disk according to the procedures described in Step 4. Store the information floppy disk because it will be used in “Restoring the cluster configuration information.”
6. Change the resource settings using the Builder.
  - disk resource
  - VxVM volume manager resource

For these group resources, make the following settings on the **Recovery operation** tab of the **Resource Properties** window:

#### Recovery operation at activation failure

Retry Count at Activation Failure	0 time
Failover Threshold	0 time
Final Action	No Operation (Next Resource Are Activated)

#### Recovery operation at deactivation failure

Retry Count at Deactivation Failure 0 time  
 Final Action No Operation (Next Resource Are Deactivated)

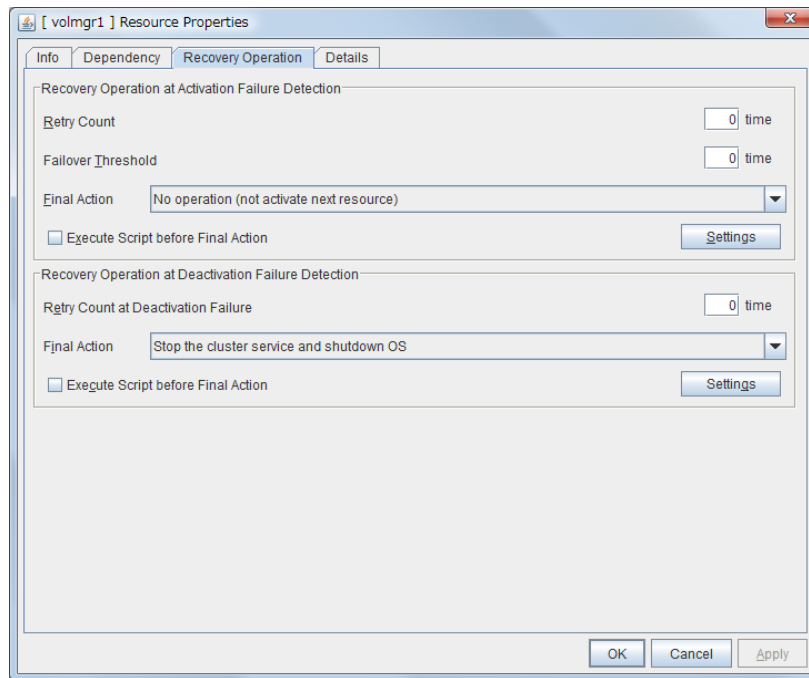

- VxVM volume manager monitor resource
- disk monitor resource

For these monitor resources, make the following settings on the **Recovery Action** tab of the **Monitor Resources Properties** window:

**Error Detection**

Recovery Action Execute only the final action  
 Final Action No Operation

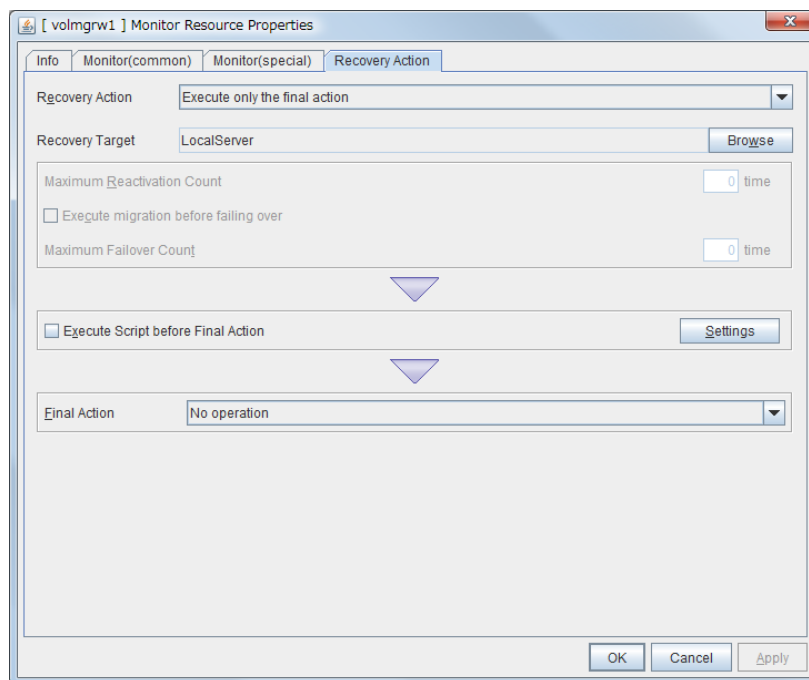

7. Load the configuration information in the floppy disk to the server. Choose Step A or B depending on the version of the floppy disk that you created with the Builder.

- Run the command below to use the floppy disk you created with the Builder for Linux.

```
clpcfctrl --push -l
```

- B. Run the command below to use the floppy disk you created with the Builder for Windows (1.44 MB formatted).

```
clpcfctrl --push -w
```

For information on troubleshooting clpcfctrl problems, see “Creating a cluster and backing up configuration data (clpcfctrl command)” in Chapter 3, “EXPRESSCLUSTER command reference” in this guide.

8. Remove the information floppy disk from the floppy disk drive.
9. Run the chkconfig command shown below on all servers to start the EXPRESSCLUSTER services.

```
chkconfig --add clusterpro_md  
chkconfig --add clusterpro  
chkconfig --add clusterpro_webmgr  
chkconfig --add clusterpro_alertsync
```

10. Restart all servers.

The services will be effective next time the OS is started.

### **Restoring the cluster configuration information**

1. Stop the EXPRESSCLUSTER daemon using the command shown below if the EXPRESSCLUSTER daemon is running.

```
clpcl -t -a
```

2. Load the configuration information of the floppy disk created in Step 5 of “To change the cluster configuration data” to the server. Choose Step A or B depending on the version of the floppy disk that you backed up.

- A. Run the command below to use the floppy disk that you backed up for Linux.

```
clpcfctrl --push -l
```

- B. Run the command below to use the floppy disk that you backed up for Windows (1.44 MB formatted).

```
clpcfctrl --push -w
```

For information on troubleshooting clpcfctrl problems, see “Creating a cluster and backing up configuration data (clpcfctrl command)” in Chapter 3, “EXPRESSCLUSTER command reference” in this guide.

3. Remove the information floppy disk from the floppy disk drive.

The setting will be effective next time the EXPRESSCLUSTER daemon is activated.

## When a kernel page allocation error occurs ~ For Replicator / Replicator DR~

When the EXPRESSCLUSTER Replicator is running on the Turbolinux 10 Server, the following message may be recorded. However, in some cases, this message may not be recorded depending on the memory size and the I/O load.

```
kernel: [kernel_module_name]: page allocation failure. order:X,  
mode:0xXX
```

When the EXPRESSCLUSTER Replicator is running on the Turbolinux 10 Server, the following messages may be recorded. However, in some cases, this message may not be recorded depending on the memory size and the I/O load.

```
/proc/sys/vm/min_free_kbytes
```

The maximum specifiable value for min\_free\_kbytes value varies depending on the physical memory size of the server. The following table shows the maximum specifiable min\_free\_kbytes values:

Physical memory size (Mbyte)	Max value
1024	1024
2048	1448
4096	2048
8192	2896
16384	4096



## To confirm the progress of the fsck / xfs\_repair command

Fsck or xfs\_repair carried out when activating a disk resource, a mirror disk resource and a hybrid disk resource may needs long time by completion by the size of the partition and the state of the file system.

It's possible to refer to the following logfile for progress of the fsck or xfs\_repair command a disk resource, a mirror disk resource and a hybrid disk resource issued and check it:

Resource type	Log file
Disk resource	disk_fsck.log.cur
Mirror disk resource	md_fsck.log.cur
Hybrid disk resource	hd_fsck.log.cur

Further, the above logfile is offered version 3.3.1-1 or later of EXPRESSCLUSTER X.



# Chapter 12 Error messages

This chapter provides information on error messages you might encounter in operating EXPRESSCLUSTER.  
This chapter covers:

- Messages ..... 1416
- Messages reported by syslog, alert, mail, and SNMP trap ..... 1416
- Driver syslog messages ..... 1489
- Detailed information in activating and deactivating group resources..... 1511
- Detailed info of monitor resource errors..... 1523
- JVM monitor resource log output messages..... 1546

## Messages

EXPRESSCLUSTER X 3.3 does not support event log (syslog) monitoring of NEC ESMPRO Agent.

EXPRESSCLUSTER X 3.3 does not notify events occurring on EXPRESSCLUSTER to NEC Express Report Service.

## Messages reported by syslog, alert, mail, and SNMP trap

If the “●” mark is shown in the alert column or the syslog column, the message on that row is output to the Alert Viewer of WebManager or syslog of OS, respectively.

If the “●” mark is shown in the mail column, the message on that row is reported when E-mail report function of Alert Service is enabled.

If the “●” mark is shown in the SNMP Trap column, the message on that row is reported when SNMP trap sending function of Alert Service is enabled.

For details of E-mail report and SNMP trapsending, see Chapter 2 “Functions of the Builder - Alert Service tab” and Chapter 8 “Information on other settings – Alert Service.”

### Note:

facility = daemon (0x00000018), identity = “expresscls” are displayed on syslogs. The “Event type” on the following list is the log level of the syslog.

Module type	Event type	Event ID	Message	Description	Solution	Reported to			
						alert	syslog	mail	SNMP Trap
pm	Info	1	Starting the cluster daemon...	The EXPRESSCLUSTER daemon has started normally.		●	●		
pm	Info	2	Shutting down the cluster daemon...	The EXPRESSCLUSTER daemon is stopping.		●	●		
pm	Info	3	Shutdown monitoring is started...	Shutdown monitoring has started.		●	●		
pm	Error	10	The cluster daemon has already started.	The EXPRESSCLUSTER daemon has already started.	Check the status of the EXPRESSCLUSTER daemon.	●	●		
pm	Error	11	A critical error occurred in the cluster daemon.	A critical error has occurred in the EXPRESSCLUSTER daemon.	Check the following possible causes: the execution user has no root permission, there is a memory shortage, or OS resources are insufficient.	●	●	●	●

Messages reported by syslog, alert, mail, and SNMP trap

Module type	Event type	Event ID	Message	Description	Solution	Reported to			
						alert	syslog	mail	SNMP Trap
pm	Error	12	A problem was detected in XML library.	A problem was detected in the XML library.	Check the following possible causes: memory shortage or OS resource insufficiency.	•	•		
pm	Error	13	A problem was detected in cluster configuration data.	A problem was detected in the cluster configuration data.	Using the Builder, check the cluster configuration data.	•	•	•	•
pm	Error	14	No cluster configuration data is found.	There is no cluster configuration data.	Create the cluster configuration with the Builder and upload it to all servers in the cluster.	•	•		
pm	Error	15	No information about this server is found in the cluster configuration data.	Information about the local server is not found in the cluster configuration data.	Using the Builder, check the cluster configuration data.	•	•		
pm	Error	20	Process %1 was terminated abnormally.	Process %1 was terminated abnormally.	Check the following possible causes: memory shortage or OS resource insufficiency.	•	•	•	•
pm	Error	21	The system will be stopped because the cluster daemon process terminated abnormally.	The system will stop because the EXPRESSCLUSTER daemon process terminated abnormally.	Deactivation of the group resource may fail. Take appropriate action according to the group resource message.	•	•		
pm	Error	22	An error occurred when initializing process %1.(return code:%2)	An error occurred in initializing process %1.	The event process may not yet have been started. See "Troubleshooting" on page 1366.	•	•	•	•
pm	Info	23	The system will be stopped.	The system will be stopped.	-	•	•		
pm	Info	24	The cluster daemon will be stopped.	The EXPRESSCLUSTER daemon will be stopped.	-	•	•		
pm	Info	25	The system will be rebooted.	The system will be rebooted.	-	•	•		
pm	Info	26	Process %1 will be restarted.	Process %1 will be restarted.	-	•	•		
pm	Info	30	Received a request to stop the system from %1.	A system stop request was received from %1.	-	•	•		
pm	Info	31	Received a request to stop the cluster daemon from %1.	An EXPRESSCLUSTER daemon stop request was received from %1.	-	•	•		

Module type	Event type	Event ID	Message	Description	Solution	Reported to			
						alert	syslog	mail	SNMP Trap
pm	Info	32	Received a request to reboot the system from %1.	A system reboot request was received from %1.		•	•		
pm	Info	33	Received a request to restart the cluster daemon from %1.	An EXPRESSCLUSTER daemon reboot request was received from %1.		•	•		
pm	Info	34	Received a request to resume the cluster daemon from %1.	A cluster resume request was received from %1.		•	•		
pm	Info	35	Received a request to suspend the cluster daemon from %1.	A cluster suspend request was received from %1.		•	•		
pm	Info	36	Received a request to panic by sysrq from %1.	A panic request by sysrq was received from %1.		•	•		
pm	Info	37	Received a request to reset by keepalive driver from %1.	A reset request by the keepalive driver was received from %1.		•	•		
pm	Info	38	Received a request to panic by keepalive driver from %1.	A panic request by the keepalive driver was received from %1.		•	•		
pm	Info	39	Received a request to reset by BMC from %1.	A reset request by BMC was received from %1.		•	•		
pm	Info	40	Received a request to power down by BMC from %1.	A power down request by BMC was received from %1.		•	•		
pm	Info	41	Received a request to power cycle by BMC from %1.	A power cycle request by BMC was received from %1.		•	•		
pm	Info	42	Received a request to send NMI by BMC from %1.	An NMI send request by BMC was received from %1.		•	•		
pm	Error	43	Received a request to send IO Fencing by ACPI driver from %1.	An IO Fencing send request by ACPI driver was received from %1.		•	•		
pm	Error	66	An attempt to panic by sysrq from %1 failed.	An attempt was made to cause a panic by sysrq from %1, but failed.	Check whether the system is configured so that it can use sysrq.	•	•		

Messages reported by syslog, alert, mail, and SNMP trap

Module type	Event type	Event ID	Message	Description	Solution	Reported to			
						alert	syslog	mail	SNMP Trap
pm	Error	67	An attempt to reset by keepalive driver from %1 failed.	An attempt was made to cause a reset by the keepalive driver from %1, but failed.	Check whether the established environment supports the use of the keepalive driver.	•	•		
pm	Error	68	An attempt to panic by keepalive driver from %1 failed.	An attempt was made to cause a panic by the keepalive driver from %1, but failed.	Check whether the established environment supports the use of the keepalive driver.	•	•		
pm	Error	69	An attempt to reset by BMC from %1 failed.	An attempt was made to cause a reset by BMC from %1, but failed.	Check whether the ipmitool, hwreset, or ireset command can be used.	•	•		
pm	Error	70	An attempt to power down by BMC from %1 failed.	An attempt was made to cause power down by BMC from %1, but failed.	Check whether the ipmitool, hwreset, or ireset command can be used.	•	•		
pm	Error	71	An attempt to power cycle by BMC from %1 failed.	An attempt was made to cause a power cycle by BMC from %1, but failed.	Check whether the ipmitool, hwreset, or ireset command can be used.	•	•		
pm	Error	72	An attempt to send NMI by BMC from %1 failed.	An attempt was made to perform an NMI transmission by BMC from %1, but failed.	Check whether the ipmitool, hwreset, or ireset command can be used.	•	•		
pm	Error	73	An attempt to send IO Fencing by ACPI driver from %1 failed.	An attempt was made to perform I/O fencing with the ACPI driver from %1, but failed.	Confirm whether the ACPI driver for EXPRESSCLUSTER linkage is available.	•	•		
pm	Info	100	The system will be panic by sysrq.	The system will be panicked by sysrq.	–	•	•		
pm	Info	101	The system will be reset by ka.	The system will be reset by the keep alive driver.	–	•	•		
pm	Info	102	The system will be panic by ka.	The system will be panicked by the keep alive driver.	–	•	•		
pm	Info	103	The system will be reset by bmc.	The system will be reset by BMC.	–	•	•		
pm	Info	104	The system will be off by bmc.	The system will be turned OFF by BMC.	–	•	•		
pm	Info	105	The system will be cycle by bmc.	The system will be turned OFF and then back ON by BMC.	–	•	•		
pm	Info	106	The system will be nmi by bmc.	The system will be NMI-transmitted by BMC.	–	•	•		
pm	Info	107	The system will be iofencing.	The system will be subject to I/O fencing.	–	•	•		

Module type	Event type	Event ID	Message	Description	Solution	Reported to			
						alert	syslog	mail	SNMP Trap
nm	Info	1	Server %1 has started.	Server %1 has started.	-	•	•		
nm	Info	2	Server %1 has been stopped.	Server %1 has stopped.	-	•	•	•	•
nm	Info	3	Resource %1 of server %2 has started.	Resource %1 of server %2 has started.	-	•	•		
nm	Info	4	Resource %1 of server %2 has stopped.	Resource %1 of server %2 has stopped.	-	•	•		
nm	Info	5	Waiting for all servers to start.	Waiting for all servers to start has started.	-	•	•		
nm	Info	6	All servers have started.	All servers have started.	-	•	•		
nm	Info	7	Timeout occurred during the wait for startup of all servers.	Waiting for all servers to start has timed out.	-	•	•		
nm	Error	8	Timeout occurred during the wait for startup of all servers. (Cannot communicate with some servers.)	Waiting for all servers to start has timed out. (Internal communication with some servers is impossible.)	Check whether there is a network adaptor error and that the network is connected properly.	•	•		
nm	Info	9	Waiting for startup of all servers has been canceled.	Waiting for servers to start has been canceled.	-	•	•		
nm	Error	10	Status of resource %1 of server %2 is unknown.	The status of resource %1 of server %2 is unknown.	Check that cable for resource %1 and the network are set correctly.	•	•	•	•
nm	Error	20	Process %1 was terminated abnormally.	Process %1 was terminated abnormally.	Check the following possible causes: memory shortage or OS resource insufficiency.	•	•	•	•
nm	Info	21	The system will be stopped.	The system will be stopped.	-	•	•		
nm	Info	22	The cluster daemon will be stopped.	The EXPRESSCLUSTER daemon will be stopped.	-	•	•		
nm	Info	23	The system will be rebooted.	The system will be rebooted.	-	•	•		
nm	Info	24	Process %1 will be restarted.	Process %1 will be restarted.	-	•	•		



Messages reported by syslog, alert, mail, and SNMP trap

Module type	Event type	Event ID	Message	Description	Solution	Reported to			
						alert	syslog	mail	SNMP Trap
nm	Error	30	Network partition was detected. Shut down the server %1 to protect data.	A network partition was detected. Server %1 is shut down to protect the data.	All heartbeats cannot be used. Check whether there is a network adaptor error and that the network is connected properly. Check the status of the shared disk if DISKHB is in use. Check that the COM cable is properly connected if COMHB is in use.	•	•		
nm	Error	31	An error occurred while confirming the network partition. Shut down the server %1.	A problem occurred while the network partition was being checked. Server %1 is shut down to protect data.	Check whether there is an error in the network partition resolution resource.	•	•		
nm	Error	32	Shut down the server %1. (reason:%2)	Server %1 is shut down. (Reason: %2)	All heartbeats cannot be used. Check whether there is a network adaptor error and that the network is connected properly. Check the status of the shared disk if DISKHB is in use. Check that the COM cable is properly connected if COMHB is in use.	•	•		
nm	Error	33	Cluster service will be stopped. (reason:%1)	The cluster service will be stopped. (Reason: %1)	Remove the factor indicated in "reason".	•	•		
nm	Error	34	The combination of the network partition resources is invalid. (server name:%1)	The combination of the network partition resolution resources is invalid. (Server name: %1)	Check the cluster configuration data.	•	•		
nm	Error	35	Failed to start the resource %1. Server name:%2	Resource %1 failed to start. (Server name: %2)	Check whether there is an error in the network partition resolution resource.	•	•		
nm	Info	36	The network partition %1 of the server %2 has been recovered to the normal status.	Network partition %1 of server %2 has been recovered to the normal status.	-	•	•		

Module type	Event type	Event ID	Message	Description	Solution	Reported to			
						alert	syslog	mail	SNMP Trap
nm	Error	37	The network partition %1 of the server %2 has an error.	Network partition %1 of server %2 is abnormal.	Check whether there is an error in the network partition resolution resource.	•	•		
nm	Error	38	The resource %1 of the server %2 is unknown.	Resource %1 of server %2 is unknown.	Check the cluster configuration data.	•	•		
nm	Info	39	The server %1 cancelled the pending failover.	Server %1 canceled the failover.	-	•	•		
nm	Error	40	Network partition was detected. Stop the cluster service on the server %1 to protect data.	A network partition was detected. The cluster service of server %1 is stopped to protect the data.	All heartbeats cannot be used. Check whether there is a network adaptor error and that the network is connected properly. Check the status of the shared disk if DISKHB is in use. Check that the COM cable is properly connected if COMHB is in use.	•	•		
nm	Error	41	An error occurred while confirming the network partition. Stop the cluster service on the server %1.	A problem occurred while the network partition was being checked. The cluster service of server %1 is stopped to protect data.	Check whether there is an error in the network partition resolution resource.	•	•		
nm	Error	42	Network partition was detected. Reboot the cluster service on the server %1 to protect data.	A network partition was detected. Server %1 is reboot to protect the data.	All heartbeats cannot be used. Check whether there is a network adaptor error and that the network is connected properly. Check the status of the shared disk if DISKHB is in use. Check that the COM cable is properly connected if COMHB is in use.	•	•		

Messages reported by syslog, alert, mail, and SNMP trap

Module type	Event type	Event ID	Message	Description	Solution	Reported to			
						alert	syslog	mail	SNMP Trap
nm	Error	43	Network partition was detected. Execute action(%1) on the server %2 to protect data.	A network partition was detected. Execute action(%1) on the server %2 to protect data.	All heartbeats cannot be used. Check whether there is a network adaptor error and that the network is connected properly. Check the status of the shared disk if DISKHB is in use. Check that the COM cable is properly connected if COMHB is in use.	•	•		
nm	Error	44	An error occurred while confirming the network partition. Reboot the server %1.	A problem occurred while the network partition was being checked. Server %1 is reboot to protect data.	Check whether there is an error in the network partition resolution resource.	•	•		
nm	Error	45	An error occurred while confirming the network partition. Execute action(%1) on the server %2.	A problem occurred while the network partition was being checked. Execute action(%1) on the server %2.	Check whether there is an error in the network partition resolution resource.	•	•		
nm	Error	46	Reboot the server %1. (reason:%2)	Server %1 is reboot. (Reason: %2)	All heartbeats cannot be used. Check whether there is a network adaptor error and that the network is connected properly. Check the status of the shared disk if DISKHB is in use. Check that the COM cable is properly connected if COMHB is in use.	•	•		
nm	Error	47	Execute action(%1) on the server %2. (reason:%3)	Execute action(%1) on the server %2. (reason:%3)	All heartbeats cannot be used. Check whether there is a network adaptor error and that the network is connected properly. Check the status of the shared disk if DISKHB is in use. Check that the COM cable is properly connected if COMHB is in use.	•	•		

Module type	Event type	Event ID	Message	Description	Solution	Reported to			
						alert	syslog	mail	SNMP Trap
nm	Error	80	Cannot communicate with server %1.	Internal communication with server %1 is impossible.	Check whether there is a network adaptor error and that the network is connected properly.	•	•		
nm	Info	81	Recovered from internal communication error with server %1.	Internal communication with server %1 has been recovered from the abnormal status.	-	•	•		
rc	Info	10	Activating group %1 has started.	Activating group %1 has started.	-	•	•		
rc	Info	11	Activating group %1 has completed.	Activating group %1 has been completed.	-	•	•		
rc	Error	12	Activating group %1 has failed.	Activating group %1 has failed.	Take appropriate action according to the group resource message.	•	•		
rc	Info	15	Waiting for group %1 to start has started.	Waiting for the group to start has started.	-	•	•		
rc	Info	16	Waiting for group %1 to start has been completed.	Waiting for the group to start has been normally completed.	-	•	•		
rc	Error	17	Group start has been cancelled because waiting for group %1 to start has timed out.	Waiting for the group to start has timed out.	Check the status of the group waiting to start. If the group has not yet been started, re-perform the group operation after starting that group.	•	•		
rc	Warning	18	Waiting for group %1 to start has timed out. However, group start continues.	Waiting for the group to start has timed out. However, group start continues.	-	•	•		
rc	Info	20	Stopping group %1 has started.	Stopping group %1 has started.	-	•	•		
rc	Info	21	Stopping group %1 has completed.	Stopping group %1 has been completed.	-	•	•		
rc	Error	22	Stopping group %1 has failed.	Stopping group %1 has failed.	Take appropriate action according to the group resource message.	•	•		

Messages reported by syslog, alert, mail, and SNMP trap

Module type	Event type	Event ID	Message	Description	Solution	Reported to			
						alert	syslog	mail	SNMP Trap
rc	Warning	23	Server %1 is not in a condition to start group %2.	Server %1 cannot start group %2.	A server on which an absolute exclusion group has already started cannot start another absolute exclusion group. Stop the existing absolute exclusion group and then reexecute.	•	•		
rc	Info	25	Waiting for group %1 to stop has started.	Waiting for the group to stop has started.	-	•	•		
rc	Info	26	Waiting for group %1 to stop has been completed.	Waiting for the dependent group to stop has been normally completed.	-	•	•		
rc	Error	27	Group stop has been cancelled because waiting for group %1 to stop has timed out.	Waiting for the group to stop has timed out.	Check the status of the group waiting to stop. If the group has not yet been stopped, re-perform the group operation after stopping that group.	•	•		
rc	Warning	28	Waiting for group %1 to stop has timed out. However, group stop continues.	Stop waiting has timed out. However, group stop continues.	-	•	•		
rc	Info	30	Activating %1 resource has started.	Activating resource %1 has started.	-		•		
rc	Info	31	Activating %1 resource has completed.	Activating resource %1 has been completed.	-		•		
rc	Error	32	Activating %1 resource has failed.(%2 : %3)	Activating resource %1 has failed.	See "Detailed information in activating and deactivating group resources" on page 1511. If a stall occurs during start processing, "Activating %1 resource has failed.(99 : command is timeout)" is output.	•	•	•	•
rc	Info	40	Stopping %1 resource has started.	Stopping resource %1 has started.	-		•		

Module type	Event type	Event ID	Message	Description	Solution	Reported to			
						alert	syslog	mail	SNMP Trap
rc	Info	41	Stopping %1 resource has completed.	Stopping resource %1 has been completed.	-		•		
rc	Error	42	Stopping %1 resource has failed.(%2 : %3)	Stopping resource %1 has failed.	See "Detailed information in activating and deactivating group resources" on page 1511. If a stall occurs during stop processing, "Stopping %1 resource has failed.(99 : command is timeout)" is output.	•	•	•	•
rc	Info	50	Moving group %1 has started.	Moving group %1 has started.	-	•	•		
rc	Info	51	Moving group %1 has completed.	Moving group %1 has been completed.	-	•	•		
rc	Error	52	Moving group %1 has failed.	Moving group %1 has failed.	Take appropriate action according to the group resource message.	•	•		
rc	Info	55	Migrating group %1 has started.	Migrating group %1 has started.	-	•	•		
rc	Info	56	Migrating group %1 has completed.	Migrating group %1 has been completed.	-	•	•		
rc	Error	57	Migrating group %1 has failed.	Migrating group %1 has failed.	Take appropriate action according to the group resource message.	•	•		
rc	Warning	58	Server %1 is not in a condition to migrate group %2.	Server %1 cannot make group %2 migrate.	Check the status of the migration destination server. If no migration destination server exists, the server name is not output to %1.	•	•		
rc	Info	60	Failover group %1 has started.	Failover of group %1 has started.	-	•	•		
rc	Info	61	Failover group %1 has completed.	Failover of group %1 has been completed.	-	•	•		
rc	Error	62	Failover group %1 has failed.	Failover of group %1 has failed.	Take appropriate action according to the group resource message.	•	•		

Messages reported by syslog, alert, mail, and SNMP trap

Module type	Event type	Event ID	Message	Description	Solution	Reported to			
						alert	syslog	mail	SNMP Trap
rc	Warning	63	Server %1 is not in a condition to move group %2.	Server %1 cannot move group %2.	Check the status of the movement destination server. If no movement destination server exists, the server name is not output to %1.	•	•		
rc	Info	64	Server %1 has been set as the destination for the group %2 (reason: %3).	Server %1 has been set as the failover destination of group %2. (Reason: %3)	-	•	•		
rc	Error	65	There is no appropriate destination for the group %1 (reason: %2).	There is no appropriate failover destination for group %1. (Reason: %2)	There is no server that can provide failover. The server is stopping or a monitor resource error disabling failover is occurring. Start the server, remove the cause of the monitor resource error, or stop the monitor resource in which the error is detected.	•	•		
rc	Warning	66	Server %1 is not in a condition to start group %2 (reason: %3).	Server %1 cannot start group %2. (Reason: %2)	There is a monitor resource error that is disabling group start. Remove the cause of the monitor resource error, or stop the monitor resource in which the error is detected.	•	•		
rc	Info	67	Server %1 in the same server group (%2) has been set as the destination for the group %3.	Server %1 in the same server group %2 has been set as the failover destination of group %3.	-	•	•		
rc	Info	68	Server %1 not in the same server group (%2) has been set as the destination for the group %3.	Server %1 in a server group other than server group %2 has been set as the failover destination of group %3.	-	•	•		

Module type	Event type	Event ID	Message	Description	Solution	Reported to			
						alert	syslog	mail	SNMP Trap
rc	Warning	69	Can not failover the group %1 because there is no appropriate destination in the same server group %2.	Server group %2 does not contain the server that can perform failover for group %1.	Start the group after starting the server in the server group or start the group with the server in another server group.	•	•		
rc	Info	70	Restarting group %1 has started.	Reactivating group %1 has started.	-	•	•		
rc	Info	71	Restarting group %1 has completed.	Reactivating group %1 has been completed.	-	•	•		
rc	Error	72	Restarting group %1 has failed.	Reactivating group %1 has failed.	Take appropriate action according to the group resource message.	•	•		
rc	Info	74	Failback group %1 has started.	Failback group %1 has started.	-	•	•		
rc	Info	75	Failback group %1 has completed.	Failback group %1 has been completed.	-	•	•		
rc	Error	76	Failback group %1 has failed.	Failback group %1 has failed.	Take appropriate action according to the group resource message.	•	•		
rc	Error	77	Failover some groups have failed since the server cannot communicate with some servers.	Failed to failover some groups because of no internal communication to some servers.	Check the status of LAN heartbeat and kernel mode LAN heartbeat. After recovering the internal communication, restart the group.	•	•		
rc	Info	80	Restarting resource %1 has started.	Reactivating resource %1 has started.	-	•	•		
rc	Info	81	Restarting resource %1 has completed.	Reactivating resource %1 has been completed.	-	•	•		
rc	Error	82	Restarting resource %1 has failed.	Reactivating resource %1 has failed.	Take appropriate action according to the group resource message.	•	•		
rc	Info	83	Starting a single resource %1.	Single resource %1 is started.	-	•	•		
rc	Info	84	A single resource %1 has been started.	Single resource %1 has been started.	-	•	•		
rc	Error	85	Failed to start a single resource %1.	Single resource %1 failed to start.	Take appropriate action according to the group resource message.	•	•		



Messages reported by syslog, alert, mail, and SNMP trap

Module type	Event type	Event ID	Message	Description	Solution	Reported to			
						alert	syslog	mail	SNMP Trap
rc	Warning	86	Server %1 is not in a condition to start a single resource %2.	Server %1 cannot start single source %2.	Check the server and group status.	•	•		
rc	Info	87	Stopping a single resource %1.	Single resource %1 is stopped.	-	•	•		
rc	Info	88	A single resource %1 has been stopped.	Single resource %1 has been stopped.	-	•	•		
rc	Error	89	Failed to stop a single resource %1.	Single resource %1 failed to stop.	Take appropriate action according to the group resource message.	•	•		
rc	Info	90	All the servers in the cluster were shut down.	The cluster has been stopped.	-	•	•		
rc	Info	91	The server was shut down.	The server has been stopped.	-	•	•		
rc	Error	92	Group %1 has started on more than one server.	Group %1 has started on two or more servers.	The server is automatically shut down. See "Recovery from network partitioning" on page 1299.	•	•	•	•
rc	Warning	100	Restart count exceeded the maximum value %1. Final action of resource %2 will not be executed.	The restart count exceeded the maximum value %1. The final action of resource %2 is not executed.	Take appropriate action according to the group resource message.	•	•		
rc	Info	121	The CPU frequency has been set to high.	The CPU clock level has been set to its highest value.	-	•	•		
rc	Info	122	The CPU frequency has been set to low.	The CPU clock level has been set to its lowest value.	-	•	•		
rc	Info	124	CPU frequency setting has been switched to automatic control by cluster.	The CPU clock setting has been switched to automatic control by the cluster.	-	•	•		
rc	Error	140	CPU frequency control cannot be used.	The CPU clock control function cannot be used.	Check the BIOS and kernel settings.	•	•		

Module type	Event type	Event ID	Message	Description	Solution	Reported to			
						alert	syslog	mail	SNMP Trap
rc	Error	141	Failed to set the CPU frequency to high.	The CPU clock level could not be set to the highest value.	Check the BIOS and kernel settings. Check whether the EXPRESSCLUSTER daemon is started. Check whether the setting to use the CPU clock control function is specified.	•	•		
rc	Error	142	Failed to set the CPU frequency to low.	The CPU clock level could not be set to the lowest value.	Same as above.	•	•		
rc	Error	144	Failed to switch the CPU frequency setting to automatic control by cluster.	The CPU clock setting could not be switched to automatic control by the cluster.	Check whether the EXPRESSCLUSTER daemon is started. Check whether the setting to use the CPU clock control function is specified.	•	•		
rc	Info	160	Script before final action upon activation failure in resource %1 started.	The script before the final action at activation failure in resource (%1) has started.		•	•		
rc	Info	161	Script before final action upon activation failure in resource %1 completed.	The script before the final action at activation failure in resource (%1) has been completed.		•	•		
rc	Info	162	Script before final action upon deactivation failure in resource %1 started.	The script before the final action at deactivation failure in resource (%1) has started.		•	•		
rc	Info	163	Script before final action upon deactivation failure in resource %1 completed.	The script before the final action at deactivation failure in resource (%1) has been completed.		•	•		
rc	Error	180	Script before final action upon activation failure in resource %1 failed.	The script before the final action at activation failure in resource (%1) has failed.	Check the cause of the script failure and take appropriate action.	•	•		
rc	Error	181	Script before final action upon deactivation failure in resource %1 failed.	The script before the final action at deactivation failure in resource (%1) has failed.	Same as above.	•	•		

Messages reported by syslog, alert, mail, and SNMP trap

Module type	Event type	Event ID	Message	Description	Solution	Reported to			
						alert	syslog	mail	SNMP Trap
rc	Info	200	Resource(%1) will be reactivated since activating resource(%2) failed.	Resource %2 is reactivated since resource %1 could not be activated.	Take appropriate action according to the group resource message.	•	•		
rc	Info	201	Group(%1) will be moved to server(%2) since activating resource(%3) failed.	Group %1 is moved to server %2 since resource %3 could not be activated.	Take appropriate action according to the group resource message.	•	•		
rc	Info	202	Group(%1) will be stopped since activating resource(%2) failed.	Group %1 is stopped since resource %2 could not be activated.	Take appropriate action according to the group resource message.	•	•		
rc	Info	203	Cluster daemon will be stopped since activating resource(%1) failed.	The cluster daemon is stopped since resource %1 could not be activated.	Take appropriate action according to the group resource message.	•	•		
rc	Info	204	System will be halted since activating resource(%1) failed.	The OS is shut down since resource %1 could not be activated.	Take appropriate action according to the group resource message.	•	•		
rc	Info	205	System will be rebooted since activating resource(%1) failed.	The OS is rebooted since resource %1 could not be activated.	Take appropriate action according to the group resource message.	•	•		
rc	Info	206	Activating group(%1) will be continued since failover process failed.	Activating group %1 is continued since the failover failed.	Take appropriate action according to the group resource message.	•	•		
rc	Info	220	Resource(%1) will be stopping again since stopping resource(%2) failed.	Deactivation of resource %1 is retried since resource %2 could not be deactivated.	Take appropriate action according to the group resource message.	•	•		
rc	Info	222	Group(%1) will be stopped since stopping resource(%2) failed.	Group %1 is stopped since resource %2 could not be deactivated.	Take appropriate action according to the group resource message.	•	•		
rc	Info	223	Cluster daemon will be stopped since stopping resource(%1) failed.	The cluster daemon is stopped since resource %1 could not be deactivated.	Take appropriate action according to the group resource message.	•	•		
rc	Info	224	System will be halted since stopping resource(%1) failed.	The OS is stopped since resource %1 could not be deactivated.	Take appropriate action according to the group resource message.	•	•		

Module type	Event type	Event ID	Message	Description	Solution	Reported to			
						alert	syslog	mail	SNMP Trap
rc	Info	225	System will be rebooted since stopping resource(%1) failed.	The OS is rebooted since resource %1 could not be deactivated.	Take appropriate action according to the group resource message.	•	•		
rc	Info	240	System panic by sysrq is requested since activating resource(%1) failed.	A system panic by sysrq is requested since resource %1 could not be activated.	Take appropriate action according to the group resource message.	•	•		
rc	Info	241	System reset by keepalive driver is requested since activating resource(%1) failed.	A system reset by the keepalive driver is requested since resource %1 could not be activated.	Take appropriate action according to the group resource message.	•	•		
rc	Info	242	System panic by keepalive driver is requested since activating resource(%1) failed.	A system panic by the keepalive driver is requested since resource %1 could not be activated.	Take appropriate action according to the group resource message.	•	•		
rc	Info	243	System reset by BMC is requested since activating resource(%1) failed.	A system reset by BMC is requested since resource %1 could not be activated.	Take appropriate action according to the group resource message.	•	•		
rc	Info	244	System power down by BMC is requested since activating resource(%1) failed.	System power down by BMC is requested since resource %1 could not be activated.	Take appropriate action according to the group resource message.	•	•		
rc	Info	245	System power cycle by BMC is requested since activating resource(%1) failed.	A system power cycle by BMC is requested since resource %1 could not be activated.	Take appropriate action according to the group resource message.	•	•		
rc	Info	246	NMI send by BMC is requested since activating resource(%1) failed.	NMI transmission by BMC is requested since resource %1 could not be activated.	Take appropriate action according to the group resource message.	•	•		
rc	Info	247	IO Fencing by ACPI driver is requested since activating resource(%1) failed.	I/O fencing with the ACPI driver was requested due to an activation failure in resource %1.	Take appropriate action according to the group resource message.	•	•		
rc	Error	260	An attempt to panic system by sysrq due to failure of resource(%1) activation failed.	An attempt was made to cause a system panic by sysrq due to an activation failure in resource %1, but failed.	Check whether the system is configured so that it can use sysrq.	•	•		

Messages reported by syslog, alert, mail, and SNMP trap

Module type	Event type	Event ID	Message	Description	Solution	Reported to			
						alert	syslog	mail	SNMP Trap
rc	Error	261	An attempt to reset system by keepalive driver due to failure of resource(%1) activation failed.	An attempt was made to cause a system reset by the keepalive driver due to an activation failure in resource %1, but failed.	Check whether the established environment supports the use of the keepalive driver.	•	•		
rc	Error	262	An attempt to panic system by keepalive driver due to failure of resource(%1) activation failed.	An attempt was made to cause a system panic by the keepalive driver due to an activation failure in resource %1, but failed.	Check whether the established environment supports the use of the keepalive driver.	•	•		
rc	Error	263	An attempt to reset system by BMC due to failure of resource(%1) activation failed.	An attempt was made to cause a system reset by BMC due to an activation failure in resource %1, but failed.	Check whether the ipmitool, hwreset, or ireset command can be used.	•	•		
rc	Error	264	An attempt to power down system by BMC due to failure of resource(%1) activation failed.	An attempt was made to cause system power down by BMC due to an activation failure in resource %1, but failed.	Check whether the ipmitool, hwreset, or ireset command can be used.	•	•		
rc	Error	265	An attempt to power cycle system by BMC due to failure of resource(%1) activation failed.	An attempt was made to cause system power cycle by BMC due to an activation failure in resource %1, but failed.	Check whether the ipmitool, hwreset, or ireset command can be used.	•	•		
rc	Error	266	An attempt to send NMI by BMC due to failure of resource(%1) activation failed.	An attempt was made to perform NMI transmission by BMC due to an activation failure in resource %1, but failed.	Check whether the ipmitool, hwreset, or ireset command can be used.	•	•		
rc	Error	267	An attempt to IO Fencing by ACPI driver due to failure of resource(%1) activation failed.	An attempt was made to perform I/O fencing by the ACPI driver due to an activation failure in resource %1, but failed.	Confirm whether the ACPI driver for EXPRESSCLUSTER linkage is available.	•	•		
rc	Info	280	System panic by sysrq is requested since deactivating resource(%1) failed.	A system panic by sysrq is requested since resource %1 could not be deactivated.	Take appropriate action according to the group resource message.	•	•		

Module type	Event type	Event ID	Message	Description	Solution	Reported to			
						alert	syslog	mail	SNMP Trap
rc	Info	281	System reset by keepalive driver is requested since deactivating resource(%1) failed.	A system reset by the keepalive driver is requested since resource %1 could not be deactivated.	Take appropriate action according to the group resource message.	•	•		
rc	Info	282	System panic by keepalive driver is requested since deactivating resource(%1) failed.	A system panic by the keepalive driver is requested since resource %1 could not be deactivated.	Take appropriate action according to the group resource message.	•	•		
rc	Info	283	System reset by BMC is requested since deactivating resource(%1) failed.	A system reset by BMC is requested since resource %1 could not be deactivated.	Take appropriate action according to the group resource message.	•	•		
rc	Info	284	System power down by BMC is requested since deactivating resource(%1) failed.	System power down by BMC is requested since resource %1 could not be deactivated.	Take appropriate action according to the group resource message.	•	•		
rc	Info	285	System power cycle by BMC is requested since deactivating resource(%1) failed.	A system power cycle by BMC is requested since resource %1 could not be deactivated.	Take appropriate action according to the group resource message.	•	•		
rc	Info	286	Sending NMI by BMC is requested since deactivating resource(%1) failed.	NMI transmission by BMC is requested since resource %1 could not be deactivated.	Take appropriate action according to the group resource message.	•	•		
rc	Info	287	IO Fencing by ACPI driver is requested since deactivating resource(%1) failed.	I/O fencing is executed by using the ACPI driver due to an activation failure in resource %1.	–	•	•		
rc	Error	300	An attempt to panic system by sysrq due to failure of resource(%1) deactivation failed.	An attempt was made to cause a system panic by sysrq due to a deactivation failure in resource %1, but failed.	Check whether the system is configured so that it can use sysrq.	•	•		
rc	Error	301	An attempt to reset system by keepalive driver due to failure of resource(%1) deactivation failed.	An attempt was made to cause a system reset by the keepalive driver due to a deactivation failure in resource %1, but failed.	Check whether the established environment supports the use of the keepalive driver.	•	•		

Messages reported by syslog, alert, mail, and SNMP trap

Module type	Event type	Event ID	Message	Description	Solution	Reported to			
						alert	syslog	mail	SNMP Trap
rc	Error	302	An attempt to panic system by keepalive driver due to failure of resource(%1) deactivation failed.	An attempt was made to cause a system panic by the keepalive driver due to a deactivation failure in resource %1, but failed.	Check whether the established environment supports the use of the keepalive driver.	•	•		
rc	Error	303	An attempt to reset system by BMC due to failure of resource(%1) deactivation failed.	An attempt was made to cause a system reset by BMC due to a deactivation failure in resource %1, but failed.	Check whether the ipmitool, hwreset, or ireset command can be used.	•	•		
rc	Error	304	An attempt to power down system by BMC due to failure of resource(%1) deactivation failed.	An attempt was made to cause system power down by BMC due to an deactivation failure in resource %1, but failed.	Check whether the ipmitool, hwreset, or ireset command can be used.	•	•		
rc	Error	305	An attempt to power cycle system by BMC due to failure of resource(%1) deactivation failed.	An attempt was made to cause system power cycle by BMC due to a deactivation failure in resource %1, but failed.	Check whether the ipmitool, hwreset, or ireset command can be used.	•	•		
rc	Error	306	An attempt to send NMI by BMC due to failure of resource(%1) deactivation failed.	An attempt was made to perform NMI transmission by BMC due to a deactivation failure in resource %1, but failed.	Check whether the ipmitool, hwreset, or ireset command can be used.	•	•		
rc	Error	307	An attempt to IO Fencing by ACPI driver due to failure of resource(%1) deactivation failed.	An attempt was made to perform I/O fencing by the ACPI driver due to an activation error in resource %1, but failed.	Confirm whether the ACPI driver for EXPRESSCLUSTER linkage is available.	•	•		
rc	Error	340	Group start has been cancelled because waiting for group %1 to start has failed.	An error has occurred while waiting for the group to start.	Check the following possible causes: memory shortage or OS resource insufficiency.	•	•		
rc	Info	400	System power down by BMC is requested. (destination server : %1)	A system power down by BMC is requested. (Target server: %1)	-	•	•		
rc	Info	401	System power cycle by BMC is requested. (destination server : %1)	System power cycle by BMC is requested. (Target server: %1)	-	•	•		

Module type	Event type	Event ID	Message	Description	Solution	Reported to			
						alert	syslog	mail	SNMP Trap
rc	Info	402	System reset by BMC is requested. (destination server : %1)	A system reset by BMC is requested. (Target server: %1)		•	•		
rc	Info	403	Sending NMI by BMC is requested. (destination server : %1)	NMI transmission by BMC is requested. (Target server: %1)		•	•		
rc	Info	410	Forced stop of virtual machine is requested. (destination server : %s)	Forced stop of a virtual machine is requested. (Target server: %1)		•	•		
rc	Info	411	Script for forced stop has started.	Script for forced-stop has started.		•	•		
rc	Info	412	Script for forced stop has completed.	Script for forced-stop has completed.		•	•		
rc	Error	420	An attempt to power down system by BMC failed. (destination server : %1)	System power down by BMC is requested, but this request failed. (Target server: %1)	Check whether the ipmitool, hwreset, or ireset command can be used.	•	•		
rc	Error	421	An attempt to power cycle system by BMC failed. (destination server : %1)	System power cycle by BMC is requested, but this request failed. (Target server: %1)	Check whether the ipmitool, hwreset, or ireset command can be used.	•	•		
rc	Error	422	An attempt to reset system by BMC failed. (destination server : %1)	A system reset by BMC is requested, but this request failed. (Target server: %1)	Check whether the ipmitool, hwreset, or ireset command can be used.	•	•		
rc	Error	423	An attempt to send NMI by BMC failed. (destination server : %1)	NMI transmission by BMC is requested, but this request failed. (Target server: %1)	Check whether the ipmitool, hwreset, or ireset command can be used.	•	•		
rc	Error	430	An attempt to force stop virtual machine failed. (destination server : %s)	Forced stop of a virtual machine is requested, but this request failed. (Target server: %1)	Check whether VMware vSphere CLI can be used.	•	•		
rc	Error	431	Script for forced stop has failed. (%1)	Script for forced stop has failed. (%1)	Check the cause of the script failure and take measures.	•	•		
rc	Error	432	Script for forced stop has timed out.	Script for forced stop has timed out.	Check the cause of the timeout and take measures.	•	•		
rc	Warning	441	Waiting for group %1 to stop has failed. However, group stop continues.	An error has occurred while waiting for the group to stop.	Check the following possible causes: memory shortage or OS resource insufficiency.	•	•		



Messages reported by syslog, alert, mail, and SNMP trap

Module type	Event type	Event ID	Message	Description	Solution	Reported to			
						alert	syslog	mail	SNMP Trap
rc	Warning	500	Since there is no other normally running server, the final action for an activation error of group resource %1 was suppressed.	Suppression of final action for activation error.	-	•	•		
rc	Warning	501	Since there is no other normally running server, the final action for a deactivation error of group resource %1 was suppressed.	Suppression of final action for deactivation error.	-	•	•		
rc	Warning	502	Since server %1 is specified as that which suppresses shutdown at both-system activation detection, it ignored the shutdown request.	Suppression of shutdown caused by both-system activation detection.	-	•	•		
rc	Warning	503	A mismatch in the group %1 status occurs between the servers.	Generation of group status mismatch	Restart the group, move it, or reboot the cluster.	•	•		
rm	Info	1	Monitoring %1 has started.	Monitoring %1 has started.	-	•	•		
rm	Info	2	Monitoring %1 has stopped.	Monitoring %1 has stopped.	-	•	•		
rm	Info	3	%1 is not monitored by this server.	%1 is not monitored by this server.	-	•	•		
rm	Warning	4	Warn monitoring %1. (%2 : %3)	Warning of monitoring %1 is issued.	See "Detailed info of monitor resource errors" on page 1523. If a monitor resource is preparing for monitoring, the following message may be set in (). No action is required for this message. (100 : not ready for monitoring.)	•	•		
rm	Warning	5	The maximum number of monitor resources has been exceeded. (registered resource is %1)	The maximum number of monitor resources has been exceeded.	Using the Builder, check the cluster configuration data.	•	•		

Module type	Event type	Event ID	Message	Description	Solution	Reported to			
						alert	syslog	mail	SNMP Trap
rm	Warning	6	Monitor configuration of %1 is invalid. (%2 : %3)	The monitor configuration of %1 is invalid.	Using the Builder, check the cluster configuration data.	•	•		
rm	Error	7	Failed to start monitoring %1.	Starting of monitoring %1 failed.	Check the following possible causes: memory shortage or OS resource insufficiency.	•	•	•	•
rm	Error	8	Failed to stop monitoring %1.	Stopping of monitoring %1 failed.	Check the following possible causes: memory shortage or OS resource insufficiency.	•	•		
rm	Error	9	Detected an error in monitoring %1. (%2 : %3)	An error was detected in monitoring %1.	See "Detailed info of monitor resource errors" on page 1523.  If a monitoring timeout is detected, the following message is set in (). (99 : Monitor was timeout.)  If Dummy Failure is enabled, the following message is set in (). No action is needed in the latter case. (201 : Monitor failed for failure verification.) If no response is returned from a monitor resource for a certain period of time, the following message is set in (). (202: couldn't receive reply from monitor resource in time.)	•	•	•	•
rm	Info	10	%1 is not monitored.	%1 is not monitored.	-	•	•		
rm / mm	Info	12	Recovery target %1 has stopped because an error was detected in monitoring %2.	Recovery target %1 has been stopped because an error was detected in monitoring %2.	-	•	•		
rm / mm	Info	13	Recovery target %1 has restarted because an error was detected in monitoring %2.	Recovery target %1 has been restarted because an error was detected in monitoring %2.	-	•	•		

Messages reported by syslog, alert, mail, and SNMP trap

Module type	Event type	Event ID	Message	Description	Solution	Reported to			
						alert	syslog	mail	SNMP Trap
rm / mm	Info	14	Recovery target %1 failed over because an error was detected in monitoring %2.	Recovery target %1 has failed over because an error was detected in monitoring %2.	-	•	•		
rm / mm	Info	15	Stopping the cluster has been required because an error was detected in monitoring %1.	A cluster stop is requested because an error was detected in monitoring %1.	-	•	•		
rm / mm	Info	16	Stopping the system has been required because an error was detected in monitoring %1.	A system stop is requested because an error was detected in monitoring %1.	-	•	•		
rm / mm	Info	17	Rebooting the system has been required because an error was detected in monitoring %1.	A system restart is requested because an error was detected in monitoring %1.	-	•	•		
rm / mm	Error	18	Attempted to stop the recovery target %1 due to the error detected in monitoring %2, but failed.	An attempt was made to stop recovery target %1 due to a %2 monitoring failure, but failed.	Check the status of resource %1.	•	•		
rm / mm	Error	19	Attempted to restart the recovery target %1 due to the error detected in monitoring %2, but failed.	An attempt was made to restart recovery target %1 due to a %2 monitoring failure, but failed.	Check the status of resource %1.	•	•		
rm / mm	Error	20	Attempted to fail over %1 due to the error detected in monitoring %2, but failed.	An attempt was made to provide failover for recovery target %1 due to a %2 monitoring failure, but failed.	Check the status of resource %1.	•	•		
rm / mm	Error	21	Attempted to stop the cluster due to the error detected in monitoring %1, but failed.	An attempt was made to stop the cluster due to a %1 monitoring failure, but failed.	Check the following possible causes: memory shortage or OS resource insufficiency.	•	•		
rm / mm	Error	22	Attempted to stop the system due to the error detected in monitoring %1, but failed.	An attempt was made to stop the system due to a %1 monitoring failure, but failed.	Check the following possible causes: memory shortage or OS resource insufficiency.	•	•		

Module type	Event type	Event ID	Message	Description	Solution	Reported to			
						alert	syslog	mail	SNMP Trap
rm / mm	Error	23	Attempted to reboot the system due to the error detected in monitoring %1, but failed.	An attempt was made to restart the system due to a %1 monitoring failure, but failed.	Check the following possible causes: memory shortage or OS resource insufficiency.	•	•		
rm	Error	24	The group of %1 resource is unknown.	The group of resource %1 is unknown.	The cluster configuration information may be mismatched. Check it.	•	•		
rm / mm	Warning	25	Recovery will not be executed since the recovery target %1 is not active.	Recovery is not performed since recovery target %1 is not active.	-	•	•		
rm / mm	Info	26	%1 status changed from error to normal.	Monitoring %1 has changed from error to normal.	-	•	•		
rm / mm	Info	27	%1 status changed from error or normal to unknown.	Monitoring %1 has changed from abnormal or normal to unknown.	Check the following possible causes: memory shortage or OS resource insufficiency.	•	•		
rm	Error	28	Initialization error of monitor process. (%1 : %2)	An error occurred while initializing the monitor process.	Check the following possible causes: memory shortage or OS resource insufficiency.	•	•		
rm	Info	29	Monitoring %1 was suspended.	Monitoring %1 has temporarily stopped.	-	•	•		
rm	Info	30	Monitoring %1 was resumed.	Monitoring %1 has restarted.	-	•	•		
rm	Info	31	All monitors were suspended.	All monitoring processes have temporarily stopped.	-	•	•		
rm	Info	32	All monitors were resumed.	All monitoring processes have restarted.	-	•	•		
rm / mm	Info	35	System panic by sysrq has been required because an error was detected in monitoring %1.	A system panic by sysrq is requested because an error was detected in monitoring %1.	-	•	•		
rm / mm	Error	36	Attempted to panic system by sysrq due to the error detected in monitoring %1, but failed.	An attempt was made to cause a system panic by sysrq due to a %1 monitoring failure, but failed.	Check whether the system is configured so that it can use sysrq.	•	•		

Messages reported by syslog, alert, mail, and SNMP trap

Module type	Event type	Event ID	Message	Description	Solution	Reported to			
						alert	syslog	mail	SNMP Trap
rm / mm	Info	37	System reset by keepalive driver has been required because an error was detected in monitoring %1.	A system reset by the keepalive driver is requested because an error was detected in monitoring %1.	-	•	•		
rm / mm	Error	38	Attempted to reset system by keepalive driver due to the error detected in monitoring %1, but failed.	An attempt was made to cause a system reset by the keepalive driver due to a %1 monitoring failure, but failed.	Check whether the established environment supports the use of the keepalive driver.	•	•		
rm / mm	Info	39	System panic by keepalive driver has been required because an error was detected in monitoring %1.	A system panic by the keepalive driver is requested because an error was detected in monitoring %1.	-	•	•		
rm / mm	Error	40	Attempted to panic system by keepalive driver due to the error detected in monitoring %1, but failed.	An attempt was made to cause a system panic by the keepalive driver due to a %1 monitoring failure, but failed.	Check whether the established environment supports the use of the keepalive driver.	•	•		
rm / mm	Info	41	System reset by BMC has been required because an error was detected in monitoring %1.	A system reset by BMC is requested because an error was detected in monitoring %1.	-	•	•		
rm / mm	Error	42	Attempted to reset system by BMC due to the error detected in monitoring %1, but failed.	An attempt was made to cause a system reset by BMC due to a %1 monitoring failure, but failed.	Check whether the ipmitool, hwreset, or ireset command can be used.	•	•		
rm / mm	Info	43	System power down by BMC has been required because an error was detected in monitoring %1.	System power down by BMC is requested because an error was detected in monitoring %1.	-	•	•		
rm / mm	Error	44	Attempted to power down system by BMC due to the error detected in monitoring %1, but failed.	An attempt was made to cause a system power down by BMC due to a %1 monitoring failure, but failed.	Check whether the ipmitool, hwreset, or ireset command can be used.	•	•		

Module type	Event type	Event ID	Message	Description	Solution	Reported to			
						alert	syslog	mail	SNMP Trap
rm / mm	Info	45	System power cycle by BMC has been required because an error was detected in monitoring %1.	System power cycle by BMC is requested because an error was detected in monitoring %1.	-	•	•		
rm / mm	Error	46	Attempted to power cycle system by BMC due to the error detected in monitoring %1, but failed.	An attempt was made to cause a system power down by BMC due to a %1 monitoring failure, but failed.	Check whether the ipmitool, hwreset, or ireset command can be used.	•	•		
rm / mm	Info	47	NMI send by BMC has been required because an error was detected in monitoring %1.	System NMI transmission by BMC is requested because an error was detected in monitoring %1.	-	•	•		
rm / mm	Error	48	Attempted to send NMI by BMC due to the error detected in monitoring %1, but failed.	An attempt was made to cause a system NMI transmission by BMC due to a %1 monitoring failure, but failed.	Check whether the ipmitool, hwreset, or ireset command can be used.	•	•		
rm	Info	50	The number of licenses is %1. (%2)	The number of cluster licenses is %1.	-	•	•		
rm/mm	Info	51	The trial license is effective until %4s/%2s/%2s. (%1)	The trial license is effective until %1.	-	•	•		
rm	Warning	52	The number of licenses is insufficient. The number of insufficient licenses is %1. (%2)	The number of licenses is insufficient.	Purchase the required number of licenses and then register them.	•	•		
rm/mm	Error	53	The license is not registered. (%1)	The license is not registered.	Purchase the license and then register it.	•	•		
rm/mm	Error	54	The trial license has expired in %4s/%2s/%2s. (%1)	The validity term of the trial license has expired.	Register a valid license.	•	•		
rm/mm	Error	55	The registered license is invalid. (%1)	The registered license is invalid.	Register a valid license.	•	•		
rm	Error	56	The registered license is unknown. (%1)	The registered license is unknown.	Register a valid license.	•	•		

Messages reported by syslog, alert, mail, and SNMP trap

Module type	Event type	Event ID	Message	Description	Solution	Reported to			
						alert	syslog	mail	SNMP Trap
rm	Error	57	Stopping the cluster is required since license (%1) is invalid.	Stopping the cluster is requested due to an invalid license.	Register a valid license.	•	•	•	•
rm	Error	58	Stopping the cluster due to invalid license (%1) failed.	Stopping the cluster due to an invalid license has failed.	Register a valid license.	•	•		
rm/mm	Error	59	The trial license is valid from %.4s/%.2s/%.2s. (%1)	The validity term of the trial license is not reached.	Register a valid license.	•	•		
rm	Warning	71	Detected a monitor delay in monitoring %1. (timeout=%2*%3 actual-time=%4 delay warning rate=%5)	A monitoring delay was detected in monitoring %1. The current timeout value is %2 (second) x %3 (tick count per second). The actual measurement value at delay detection is %4 (tick count) and exceeded the delay warning rate %5 (%).	Check the load status of the server on which a monitoring delay was detected and remove the load.  If a monitoring timeout is detected, extend it.	•	•		
rm / mm	Info	81	Script before %1 upon failure in monitor resource %2 started.	Script before %1 of monitor resource %2 has started.	-	•	•		
rm / mm	Info	82	Script before %1 upon failure in monitor resource %2 completed.	Script before %1 of monitor resource %2 has been completed.	-	•	•		
rm / mm	Error	83	Script before %1 upon failure in monitor resource %2 failed.	Script before %1 of monitor resource %2 has failed.	Check the cause of the script failure and take appropriate action.	•	•		
rm	Warning	100	Restart count exceeded the maximum of %1. Final action of monitoring %2 will not be executed.	Because the restart count has exceeded the maximum value %1, the final action of %2 was not executed.	-	•	•		
rm	Warning	120	The virtual machine (%1) has been migrated to %2 by an external operation.	The virtual machine managed by resource %1 was made to migrate to server %2 through external operation.	-	•	•		

Module type	Event type	Event ID	Message	Description	Solution	Reported to			
						alert	syslog	mail	SNMP Trap
rm	Warning	121	The virtual machine (%1) has been started by an external operation.	The virtual machine managed by resource %1 was started by external operation.	-	•	•		
rm	Info	130	The collecting of detailed information triggered by monitor resource %1 error has been started (timeout=%2).	Collecting of detailed information triggered by detection of a monitor resource %1 monitoring error has started. The timeout is %2 seconds.	-	•	•		
rm	Info	131	The collection of detailed information triggered by monitor resource %1 error has been completed.	Collecting of detailed information triggered by detection of a monitor resource %1 monitoring error has been completed.	-	•	•		
rm	Warning	132	The collection of detailed information triggered by monitor resource %1 error has been failed (%2).	Collecting of detailed information triggered by detection of a monitor resource %1 monitoring error has failed.	-	•	•		
rm	Info	140	Process %1 has started.	Process %1 has started.	-	•	•		
rm	Warning	141	Process %1 has restarted.	Process %1 has restarted.	-	•	•		
rm	Warning	142	Process %1 does not exist.	Process %1 does not exist.	-	•	•		
rm	Abnormal	143	Process %1 was restarted %2 times, but terminated abnormally.	Process %1 was restarted %2 times, but terminated abnormally.	Check the following possible causes: memory shortage or OS resource insufficiency.	•	•		
rm	Abnormal	150	The cluster is stopped since process %1 was terminated abnormally.	The cluster is stopped since process %1 was terminated abnormally.	Check the following possible causes: memory shortage or OS resource insufficiency.	•	•		
rm	Error	151	The server is shut down since process %1 was terminated abnormally.	The server is shut down since process %1 was terminated abnormally.	Check the following possible causes: memory shortage or OS resource insufficiency.	•	•		
rm	Error	152	The server is restarted since process %1 was terminated abnormally.	The server is restarted since process %1 was terminated abnormally.	Check the following possible causes: memory shortage or OS resource insufficiency.	•	•		



Messages reported by syslog, alert, mail, and SNMP trap

Module type	Event type	Event ID	Message	Description	Solution	Reported to			
						alert	syslog	mail	SNMP Trap
rm	Error	160	Monitor resource %1 cannot be controlled since the license is invalid.	Monitor resource %1 cannot be controlled since the license is invalid.	Register a valid license.	•	•		
rm	Normal	170	Recovery script has been executed since an error was detected in monitoring %1.	Recovery script has been executed since an error was detected in monitoring %1.	-	•	•		
rm	Error	171	An attempt was made to execute the recovery script due to a %1 monitoring failure, but failed.	An attempt was made to execute the recovery script due to a %1 monitoring failure, but failed.	Check the cause of the recovery script failure and take appropriate action.	•	•		
rm	Info	180	Dummy Failure of monitor resource %1 is enabled.	Dummy Failure of monitor resource %1 is enabled.	-	•	•		
rm	Info	181	Dummy Failure of monitor resource %1 is disabled.	Dummy Failure of monitor resource %1 is disabled.	-	•	•		
rm	Info	182	Dummy Failure of all monitor will be enabled.	Dummy Failure of all monitor will be enabled.	-	•	•		
rm	Info	183	Dummy Failure of all monitor will be disabled.	Dummy Failure of all monitor will be disabled.	-	•	•		
rm	Warning	184	An attempt was made to enable Dummy Failure of monitor resource %1, but failed.	An attempt was made to enable Dummy Failure of monitor resource %1, but failed.	Check whether monitor resource %1 corresponds to Dummy Failure.	•	•		
rm	Warning	185	An attempt was made to disable Dummy Failure of monitor resource %1, but failed.	An attempt was made to disable Dummy Failure of monitor resource %1, but failed.	Check whether monitor resource %1 corresponds to Dummy Failure.	•	•		
rm	Info	190	Recovery action caused by monitor resource error is disabled.	Recovery action caused by monitor resource error is disabled.	-	•	•		
rm	Info	191	Recovery action caused by monitor resource error is enabled.	Recovery action caused by monitor resource error is enabled.	-	•	•		

Module type	Event type	Event ID	Message	Description	Solution	Reported to			
						alert	syslog	mail	SNMP Trap
rm	Warning	192	Ignored the recovery action in monitoring %1 because recovery action caused by monitor resource error is disabled.	Ignored the recovery action in monitoring %1 because recovery action caused by monitor resource error is disabled.	-	•	•		
rm	Warning	193	Recovery action at timeout occurrence was disabled, so the recovery action of monitor %1 was not executed.	Recovery action at timeout occurrence was disabled, so the recovery action of monitor %1 was not executed.	-	•	•		
rm	Warning	200	Since there is no other normally running server, the final action(%1) for the error detection of monitor resource %2 was suppressed.	Suppression of final action for error detection.	-	•	•		
rm/mm	Info	210	IO Fencing by ACPI driver has been required because an error was detected in monitoring %1.	I/O fencing by the ACPI driver is necessary because an error was detected in monitoring %1.	-	•	•		
rm/mm	Error	211	Attempted to IO Fencing by ACPI driver due to the error detected in monitoring %1, but failed.	An attempt was made to perform I/O fencing by the ACPI driver in response to the error detected in monitoring %1, but failed.	Confirm whether the ACPI driver for EXPRESSCLUSTER linkage can be used in the environment.	•	•		
rm	Warning	220	Recovery will not be executed since any recovery target is not active.	Recovery will not be executed since any recovery target is not active.	-	•	•		
mm	Info	901	Message monitor has been started.	Message monitor (external linkage monitor module) has been started.	-	•	•		
mm	Error	902	Failed to initialize message monitor. (%1 : %2)	Message monitor (external linkage monitor module) could not be initialized.	Check the following possible causes: memory shortage or OS resource insufficiency.	•	•		
mm	Warning	903	An error of %1 type and %2 device has been detected. (%3)	External error %3 of category %1 and keyword %2 has been received.	-	•	•		

Messages reported by syslog, alert, mail, and SNMP trap

Module type	Event type	Event ID	Message	Description	Solution	Reported to			
						alert	syslog	mail	SNMP Trap
mm	Error	905	An error has been detected in monitoring %1. (%2)	An error was detected in monitor resource %1 monitoring.	Take appropriate action according to the %2 message.	•	•	•	•
mm	Error	906	Message monitor was terminated abnormally.	Message monitor (external linkage monitor module) has been terminated abnormally.	Check the following possible causes: memory shortage or OS resource insufficiency.	•	•		
mm	Error	907	Failed to execute action. (%1)	Executing recovery action has failed.	Check the following possible causes: memory shortage or OS resource insufficiency.	•	•		
mm	Info	908	The system will be stopped.	The OS will be shut down.	-	•	•		
mm	Info	909	The cluster daemon will be stopped.	The cluster will be stopped.	-	•	•		
mm	Info	910	The system will be rebooted.	The OS will be rebooted.	-	•	•		
mm	Info	911	Message monitor will be restarted.	Message monitor (external linkage monitor module) will be restarted.	-	•	•		
mm	Info	912	Received a message by SNMP Trap from external. (%1 : %2)	Received a message by SNMP Trap from external.	-	•	•		
mm	Info	913	Received a Fatal Trap from %1. (msg : No data)	A Fatal Trap was received from the server %1. The message does not contain any information .	-	•	•		
mm	Info	914	Received a Fatal Trap from %1. (msg : %2)	A Fatal Trap was received from the server %1. The message contains information (%2). For information about %2 (failure region), see the <i>Device Maintenance Guide</i> <sup>1</sup> ..	-	•	•		

<sup>1</sup> For details of failure regions, see "List of ExpressCluster Failure Region Codes", contained in the "Appendix" chapter in the maintenance guide of each device.  
Section III Maintenance information

Module type	Event type	Event ID	Message	Description	Solution	Reported to			
						alert	syslog	mail	SNMP Trap
mm	Warning	915	Received a Recoverable Trap.(Performance degradation) (msg : %1)	A Recoverable Trap was received. (Performance degradation was detected.). The message contains information (%1). For information about %1 (failure region), see the <i>Device Maintenance Guide</i> <sup>1</sup> .		•	•		
mm	Warning	916	Received a Recoverable Trap.(Predict) (msg : %1)	A Recoverable Trap was received. (A predictive failure was detected.). The message contains information (%1). For information about %1 (failure region), see the <i>Device Maintenance Guide</i> <sup>1</sup> .		•	•		
mm	Warning	917	Received a Recoverable Trap.(Performance degradation & Predict) (msg : %1)	A Recoverable Trap was received. (A predictive failure was detected.) The message contains information (%1). For information about %1 (failure region), see the <i>Device Maintenance Guide</i> <sup>1</sup> .		•	•		
trnsv	Error	1	There was a notification from external (IP=%1), but it was denied.	A notification was received from %1, but was not permitted.		•	•		
trnsv	Info	10	There was a notification (%1) from external (IP=%2).	A notification (%1) from %2 was accepted.		•	•		
trnsv	Info	20	Recovery action (%1) of monitoring %2 has been executed because a notification arrived from external.	Recovery action (%1) of monitor resource %2 has started through an external notification.		•	•		
trnsv	Info	21	Recovery action (%1) of monitoring %2 has been completed.	Recovery action (%1) of monitor resource %2 has been successful.		•	•		

Messages reported by syslog, alert, mail, and SNMP trap

Module type	Event type	Event ID	Message	Description	Solution	Reported to			
						alert	syslog	mail	SNMP Trap
trnsv	Error	22	Attempted to recovery action (%1) of monitoring %2, but it failed.	An attempt was made to perform recovery action (%1) of monitor resource %2, but failed.	Check whether the environment supports the recovery action.	•	•		
trnsv	Info	30	Action (%1) has been completed.	Action (%1) has been successful.	-	•	•		
trnsv	Error	31	Attempted to execute action (%1), but it failed.	An attempt was made to perform action (%1), but failed.	Check whether the environment supports the action.	•	•		
trnsv	Info	40	Script before action of monitoring %1 has been executed.	Script before the recovery action of monitor resource (%1) has been executed.	-	•			
trnsv	Info	41	Script before action of monitoring %1 has been completed.	Script before the recovery action of monitor resource (%1) has been executed successfully.	-	•			
trnsv	Error	42	Attempted to execute script before action of monitoring %1, but it failed.	Script before the recovery action of monitor resource (%1) could not be executed.	Check whether the script before the recovery action is executable.	•			
trnsv	Error	50	The system will be shutdown because cluster resume was failed.	The system will be shutdown because cluster resume was failed.	-		•		
trnsv	Error	51	An attempt to shutdown the system failed.	An attempt to shutdown the system failed.	The system may not be able to operate properly.		•		
trnsv	Info	83	Starting a dynamic adding resource %1.	Resource %1 has been dynamically added.	-	•	•		
trnsv	Info	84	A dynamic adding resource %1 has been started.	Resource %1 succeeded in being dynamically added.	-	•	•		
trnsv	Error	85	Failed to a dynamic adding resource %1.	Resource %1 failed to be dynamically added.	Take appropriate action according to the group resource message.	•	•		
trnsv	Warning	86	Server %1 is not in a condition to start a dynamic adding resource %2.	Server %1 cannot dynamically add Resource %2.	Check the server and group status.	•	•		
trnsv	Info	87	Deleting a resource %1.	Resource %1 has been deleted.	-	•	•		
trnsv	Info	88	Deleting a resource %1 has been stopped.	Resource %1 succeeded in being deleted.	-	•	•		

Module type	Event type	Event ID	Message	Description	Solution	Reported to			
						alert	syslog	mail	SNMP Trap
trnsv	Error	89	Failed to Delete a resource %1.	Resource %1 failed to be deleted.	Take appropriate action according to the group resource message.	•	•		
lanhb	Warning	71	Heartbeats sent from HB resource %1 of server %2 are delayed.(timeout=%3*%4 actual-time=%5 delay warning rate=%6)	Heartbeats from HB resource %1 of server %2 are delayed. The current timeout value is %3 (second) x %4 (tick count per second). The actual measurement value at delay generation is %5 (tick count) and exceeded the delay warning rate %6 (%).	Check the load status of the server %2 and remove the load.  If an HB timeout occurs, extend it.	•	•		
lanhb	Warning	72	Heartbeats sent from HB resource %1 are delayed.(server=%2 timeout=%3*%4 actual-time=%5 delay warning rate=%6)	Heartbeats sent from HB resource %1 are delayed. The transmission destination server is %2. The current timeout value is %3 (second) x %4 (tick count per second). The actual measurement value at delay generation is %5 (tick count) and exceeded the delay warning rate %6 (%).	Check the load status of the server to which a delay warning was issued and remove the load.  If an HB timeout occurs, extend it.				
lanhb	Warning	73	Heartbeats received by HB resource %1 are delayed.(server=%2 timeout=%3*%4 actual-time=%5 delay warning rate=%6)	Heartbeats received by HB resource %1 are delayed. The transmission source server is %2. The current timeout value is %3 (second) x %4 (tick count per second). The actual measurement value at delay generation is %5 (tick count) and exceeded the delay warning rate %6 (%).	Check the load status of the server to which a delay warning was issued and remove the load.  If an HB timeout occurs, extend it.				
lankhb	Warning	71	Heartbeats sent from HB resource %1 of	Heartbeats from HB resource %1 of server %2 are delayed.	Check the load status of the server %2 and remove the load.	•	•		

Messages reported by syslog, alert, mail, and SNMP trap

Module type	Event type	Event ID	Message	Description	Solution	Reported to			
						alert	syslog	mail	SNMP Trap
			server %2 are delayed.(timeout=%3*%4 actual-time=%5 delay warning rate=%6)	The current timeout value is %3 (second) x %4 (tick count per second). The actual measurement value at delay generation is %5 (tick count) and exceeded the delay warning rate %6 (%).	If an HB timeout occurs, extend it.				
lankhb	Warning	73	Heartbeats received from HB resource %1 is delayed.(timeout=%2*%3 actual-time=%4 delay warning rate=%5)	Heartbeats received by HB resource %1 are delayed. The transmission source server is %2. The current timeout value is %3 (second) x %4 (tick count per second). The actual measurement value at delay generation is %5 (tick count) and exceeded the delay warning rate %6 (%).	Check the load status of the server to which a delay warning was issued and remove the load.  If an HB timeout occurs, extend it.				
diskhb	Error	10	Device(%1) of resource(%2) does not exist.	No device exists.	Check the cluster configuration data.	•	•		
diskhb	Error	11	Device(%1) of resource(%2) is not a block device.	No device exists.	Check the cluster configuration data.	•	•		
diskhb	Error	12	Raw device(%1) of resource(%2) does not exist.	No device exists.	Check the cluster configuration data.	•	•		
diskhb	Error	13	Binding device(%1) of resource(%2) to raw device(%3) failed.	No device exists.	Check the cluster configuration data.	•	•		
diskhb	Error	14	Raw device(%1) of resource(%2) has already been bound to other device.	Raw device %1 of resource %2 has already been bound to another device.	Set the raw device that is not in use.	•	•		
diskhb	Error	15	File system exists on device(%1) of resource(%2).	Device %1 of resource %2 contains the file system.	To use device %1, delete the file system.	•	•		
diskhb	Info	20	Resource %1 recovered from initialization error.	Resource %1 was recovered from an initialization error.	-	•	•		
diskhb	Warning	71	Heartbeats sent from HB resource %1 of	Heartbeats from HB resource %1 of server %2 are delayed.	Check the load status of the server %2 and remove the load.	•	•		

Module type	Event type	Event ID	Message	Description	Solution	Reported to			
						alert	syslog	mail	SNMP Trap
			server %2 are delayed.(timeout=%3*%4 actual-time=%5 delay warning rate=%6)	The current timeout value is %3 (second) x %4 (tick count per second). The actual measurement value at delay generation is %5 (tick count) and exceeded the delay warning rate %6 (%).	If an HB timeout occurs, extend it.				
diskhb	Warning	72	Heartbeat write of HB resource %1 is delayed.(server=%2 timeout=%3*%4 actual-time=%5 delay warning rate=%6).	Heartbeats written by HB resource %1 are delayed. The write destination server is %2. The current timeout value is %3 (second) x %4 (tick count per second). The actual measurement value at delay generation is %5 (tick count) and exceeded the delay warning rate %6 (%).	Check the load status of the server to which a delay warning was issued and remove the load.  If an HB timeout occurs, extend it.				
diskhb	Warning	73	Heartbeat read of HB resource %1 is delayed.(server=%2 timeout=%3*%4 actual-time=%5 delay warning rate=%6)	Heartbeats read by HB resource %1 are delayed. The read source server is %2. The current timeout value is %3 (second) x %4 (tick count per second). The actual measurement value at delay generation is %5 (tick count) and exceeded the delay warning rate %6 (%).	Check the load status of the server to which a delay warning was issued and remove the load.  If an HB timeout occurs, extend it.				
comhb	Info	1	Device (%1) does not exist.	No device exists.	Check the cluster configuration data.	•	•		
comhb	Info	2	Failed to open the device (%1).	The device could not be opened.	Check the following possible causes: memory shortage or OS resource insufficiency.	•	•		
comhb	Warning	71	Heartbeats sent from HB resource %1 of	Heartbeats from HB resource %1 of server %2 are delayed.	Check the load status of the server %2 and remove the load.	•	•		



Messages reported by syslog, alert, mail, and SNMP trap

Module type	Event type	Event ID	Message	Description	Solution	Reported to			
						alert	syslog	mail	SNMP Trap
			server %2 are delayed.(timeout=%3*%4 actual-time=%5 delay warning rate=%6)	The current timeout value is %3 (second) x %4 (tick count per second). The actual measurement value at delay generation is %5 (tick count) and exceeded the delay warning rate %6 (%).	If an HB timeout occurs, extend it.				
comhb	Warning	72	Heartbeat write of HB resource %1 is delayed.(server=%2 timeout=%3*%4 actual-time=%5 delay warning rate=%6).	Heartbeats written by HB resource %1 are delayed. The transmission destination server is %2. The current timeout value is %3 (second) x %4 (tick count per second). The actual measurement value at delay generation is %5 (tick count) and exceeded the delay warning rate %6 (%).	Check the load status of the server to which a delay warning was issued and remove the load.  If an HB timeout occurs, extend it.				
comhb	Warning	73	Heartbeat read of HB resource %1 is delayed.(server=%2 timeout=%3*%4 actual-time=%5 delay warning rate=%6)	Heartbeats read by HB resource %1 are delayed. The transmission source server is %2. The current timeout value is %3 (second) x %4 (tick count per second). The actual measurement value at delay generation is %5 (tick count) and exceeded the delay warning rate %6 (%).	Check the load status of the server to which a delay warning was issued and remove the load.  If an HB timeout occurs, extend it.				
bmchb	Error	10	Failed to initialize to BMC.	BMC initialization failed.	Check whether the hardware can use the BMC linkage function.	•	•		
bmchb	Warning	71	Heartbeats sent from HB resource %1 of server %2 are delayed.(timeout=%3*%4 actual-time=%5 delay warning rate=%6)	Heartbeats from HB resource %1 of server %2 are delayed. The current timeout value is %3 (second) x %4 (tick count per second). The actual measurement value at delay generation is %5 (tick count) and exceeded the delay warning rate %6 (%).	Check the load status of the server %2 and remove the load.  If an HB timeout occurs, extend it.	•	•		

Module type	Event type	Event ID	Message	Description	Solution	Reported to			
						alert	syslog	mail	SNMP Trap
monp	Error	1	An error occurred when initializing monitored process %1. (status=%2)	An error occurred in initializing monitored process %1.	Check the following possible causes: memory shortage, OS resource insufficiency, or cluster configuration data mismatching.	•	•		
					If cluster configuration data has not yet been registered, the following process message is output. However, there is no problem.				
					+ mdagnt				
					+ webmgr				
					+ webalert				
monp	Error	2	Monitor target process %1 terminated abnormally. (status=%2)	Monitored process %1 has terminated abnormally.	Check the following possible causes: memory shortage or OS resource insufficiency.	•	•		
monp	Info	3	Monitor target process %1 will be restarted.	Monitored process %1 will be restarted.	-	•	•		
monp	Info	4	The cluster daemon will be stopped since the monitor target process %1 terminated abnormally.	The cluster will be stopped since monitored process %1 has terminated abnormally.	-	•	•		
monp	Error	5	Attempted to stop the cluster daemon, but failed.	An attempt was made to stop the cluster, but failed.	Check the following possible causes: cluster not yet activated, memory shortage, or OS resource insufficiency.	•	•		
monp	Info	6	The system will be stopped since the monitor target process %1 terminated abnormally.	The system will be stopped since monitored process %1 has terminated abnormally.	-	•	•		
monp	Error	7	Attempted to stop the system, but failed. (status=%#x)	An attempt was made to stop the system, but failed.	Check the following possible causes: cluster not yet activated, memory shortage, or OS resource insufficiency.	•	•		

Messages reported by syslog, alert, mail, and SNMP trap

Module type	Event type	Event ID	Message	Description	Solution	Reported to			
						alert	syslog	mail	SNMP Trap
monp	Info	8	System will be rebooted since monitor target process %1 terminated abnormally.	The system will be restarted since monitored process %1 has terminated abnormally.		•	•		
monp	Error	9	Attempted to reboot the system, but failed. (status=%#x)	An attempt was made to restart the system, but failed.	Check the following possible causes: cluster not yet activated, memory shortage, or OS resource insufficiency.	•	•		
md hd	Error	1	Failed to activate mirror disk. %1(Device:%2)	Activating %2 has failed. The following messages may be output to %1:	Take appropriate action according to the message displayed in %1.	•	•		
				1) Failed to open I/O port.	1) The port could not be opened. Check the cluster configuration data.				
				2) The local server doesn't have the latest data.	2) The local server does not have the latest data. Mirror recovery is needed.				
				3) Communication to the remote server failed.	3) Communication with a remote server failed. Check the connection status of the mirror disk connection.				
				4) The remote server is active.	4) The remote server has already been activated. Check the status of the mirror disk resource.				
				5) The local server is already active.	5) The local server has already been activated. Check the status of the mirror disk resource.				
				6) Mount operation failed.	6) The mount operation failed. Check whether the mount point exists. Alternatively, check whether the mount option of the cluster configuration data is correct.				

Module type	Event type	Event ID	Message	Description	Solution	Reported to			
						alert	syslog	mail	SNMP Trap
				7) NMP size of the local server is greater than that of the remote server.	7) The NMP size of the local server is greater than that of the remote server. Execute forced mirror recovery using the remote server as the mirror recovery source server.				
				8) Failed to set writable mode for data partition	Restart the server which tried to activate the resource. Note that failover may occur when the server is restarted.				
md hd	Info	2	fsck to %1 has started.	fsck of %1 has started.	-	•	•		
md hd	Info	3	fsck to %1 was successful.	fsck of %1 has been successful.	-	•	•		
md hd	Error	4	Failed to deactivate mirror disk. %1(Device:%2 )	Deactivating %2 has failed. The following messages may be output to %1: 1) The mirror disk has already been deactivated. 2) Unmount operation failed.	Take appropriate action according to the message displayed in %1. 1) The mirror disk has already been deactivated. Check the status of the mirror disk resource. 2) The unmount operation failed. Check whether the file system of the mirror disk resource is busy.	•	•		
md hd	Info	16	Initial mirror recovery of %1 has started.	Preparation for initial mirror construction of %1 has started.	-	•	•		
md hd	Info	18	Initial mirror recovery of %1 was successful.	Preparation for initial mirror construction of %1 has been successful.	-	•	•		
md hd	Warning	24	One of the servers is active, but the NMP size of mirror disks are not the same. (Device:%1)	One of the servers is active. The NMP sizes do not match, however.	Execute forced mirror recovery using the active server as the mirror recovery source server.	•	•		
md hd	Error	37	%1 of %2 failed(ret=%3).	Command %1 of device %2 failed with return value %3.	See the manual for command %1.	•	•		

Messages reported by syslog, alert, mail, and SNMP trap

Module type	Event type	Event ID	Message	Description	Solution	Reported to			
						alert	syslog	mail	SNMP Trap
md hd	Warning	38	Executing %1 of %2 with %3 option is necessary. Execute the command manually.	Executing command %1 of device %2 with option %3 specified is necessary. Execute the command manually.	Execute command %1 manually with option %3 specified.	•	•		
md hd	Info	39	%1 of %2 with %3 option has started.	Command %1 of device %2 with option %3 specified has started.	-	•	•		
md hd	Info	44	Mirror recovery of %1 was canceled.	Mirror recovery of %1 has been canceled.	-	•	•		
md hd	Info	45	Failed to cancel mirror recovery of %1.	Mirror recovery of %1 could not be canceled.	Stop the mirror recovery again.	•	•		
md hd	Error	46	umount timeout. Make sure that the length of Unmount Timeout is appropriate. (Device:%1)	Unmount of mirror %1 has timed out.	Check whether the unmount timeout setting is sufficiently long. (Refer to "Notes on stopping mirror disk resources or hybrid disk resources" and "Cache swell by a massive I/O" in "Notes and Restrictions" in the <i>Getting Started Guide</i> .)	•	•		
md hd	Error	47	fsck timeout. Make sure that the length of Fck Timeout is appropriate. (Device:%1)	fsck that was run prior to mount of mirror %1 has timed out.	Check whether the fsck timeout setting is sufficiently long. (Refer to "fsck execution" in "Notes and Restrictions" in the <i>Getting Started Guide</i> .)	•	•		
mdadm	Error	2	Failed to activate mirror disk. %1(Device:%2)	Activating %2 has failed. The following messages may be output to %1:	Take appropriate action according to the message displayed in %1.	•	•		
				1) Failed to open I/O port.	1) The port could not be opened. Check the cluster configuration data.				
				2) The local server doesn't have the latest data.	2) The local server does not have the latest data. Mirror recovery is needed.				
				3) Communication to the remote server failed.	3) Communication with a remote server failed. Check the connection status of the mirror disk connection.				

Module type	Event type	Event ID	Message	Description	Solution	Reported to			
						alert	syslog	mail	SNMP Trap
				4) The remote server is active.	4) The remote server has already been activated. Check the status of the mirror disk resource.				
				5) The local server is already active.	5) The local server has already been activated. Check the status of the mirror disk resource.				
				6) Mount operation failed.	6) The mount operation failed. Check whether the mount point exists. Alternatively, check whether the mount option of the cluster configuration data is correct.				
				7) NMP size of the local server is greater than that of the remote server.	7) The NMP size of the local server is greater than that of the remote server. Execute forced mirror recovery using the remote server as the mirror recovery source server.				
				8) One of other inter-connection works well except mirror disk connections.	8) Check that the LAN for mirror connection is normal.				
				9) Replicator license is invalid or expired.	9) Register a valid license.				
mdadm	Info	2	fsck to %1 has started.	fsck of %1 has started.	-	•	•		
mdadm	Info	3	fsck to %1 was successful.	fsck of %1 has been successful.	-	•	•		
mdadm	Error	4	Failed to deactivate mirror disk. %1(Device:%2)	Deactivating %2 has failed. The following messages may be output to %1: 1) The mirror disk has already been deactivated. 2) Unmount operation failed.	Take appropriate action according to the message displayed in %1. 1) The mirror disk has already been deactivated. Check the status of the mirror disk resource. 2) The unmount operation failed. Check whether the file system of the mirror disk resource is busy.	•	•		

Messages reported by syslog, alert, mail, and SNMP trap

Module type	Event type	Event ID	Message	Description	Solution	Reported to			
						alert	syslog	mail	SNMP Trap
mdadm	Error	5	Failed to recover the mirror. %1(Device: %2)	Mirror recovery of %2 has failed. The following messages may be output to %1:	Take appropriate action according to the message displayed in %1.	•	•		
				1) The recovery is in progress.	1) Mirror recovery is in progress. Wait for the completion of the mirror recovery and then reexecute.				
				2) The destination server is active.	2) The mirror disk resource has already been activated on the copy destination server. Check the status of the mirror disk resource.				
				3) Cannot determine the mirror recovery direction.	3) The mirror recovery direction cannot be determined. Perform forced mirror recovery.				
				4) The source server is abnormal.	4) The copy source server is abnormal. Check the status of the mirror agent.				
				5) NMP size of recovery destination is smaller.	5) Change the mirror recovery direction. If the mirror recovery direction cannot be changed, exchange the mirror recovery destination mirror disk and allocate a data partition of sufficient size. Alternatively, allocate a data partition of sufficient size using the fdisk command or the like.				
				6) Replicator license is invalid or expired.	6) Register a valid license.				
mdadm	Info	6	Mirror recovery of %1 was completed successfully.	Mirror recovery of %1 has been successful.	-	•	•		

Module type	Event type	Event ID	Message	Description	Solution	Reported to			
						alert	syslog	mail	SNMP Trap
mdadm	Info	7	Mirror recovery mode is %1.(Device:%2)	The mirror recovery mode is %1. When %1 is "NORMAL", full-scale mirror recovery (Full Copy) is performed. When %1 is "FAST", difference mirror recovery is performed.		•	•		
mdadm	Info	8	The number of Replicator Option licenses is %1. (%2)	The number of Replicator Option licenses is %1.		•	•		
mdadm	Info	9	The trial license is effective until %1. (%2)	The trial license is effective until %1.		•	•		
mdadm	Error	10	The registered license is unknown. (%1)	The registered license is unknown.	Register a valid license.	•	•		
mdadm	Error	11	The registered license is invalid. (%1)	The registered license is invalid.	Register a valid license.	•	•		
mdadm	Error	12	The license is not registered. (%1)	The license is not registered.	Purchase the license and then register it.	•	•		
mdadm	Warning	13	The number of licenses %1 is insufficient. (%2)	The number of licenses is insufficient.	Purchase the required number of licenses and then register them.	•	•		
mdadm	Error	14	The trial license expired in %1. (%2)	The validity term of the trial license has expired.	Register a valid license.	•	•		
mdadm	Error	15	The trial license is effective from %1. (%2)	The validity term of the trial license is not reached.	Register a valid license.	•	•		
mdadm	Info	16	Initial mirror recovery of %1 has started.	Initial mirror construction of %1 has started.		•	•		
mdadm	Info	17	Mirror recovery of %s has started.(%d bytes)	Mirror recovery of %1 has started.		•	•		
mdadm	Info	18	Initial mirror recovery of %1 was successful.	Initial mirror construction of %1 has been successful.		•	•		
mdadm	Error	19	Failed to perform initial mirror recovery. %1(Device:%2)	Initial mirror construction of %2 has failed. The following messages may be output to %1:	Take appropriate action according to the message displayed in %1.	•	•		



Messages reported by syslog, alert, mail, and SNMP trap

Module type	Event type	Event ID	Message	Description	Solution	Reported to			
						alert	syslog	mail	SNMP Trap
				1) The recovery is in progress.	1) Mirror recovery is in progress. Wait for the completion of the mirror recovery and then reexecute.				
				2) The destination server is active.	2) The resource has already been activated on the copy destination server. Check the status of the mirror disk resource.				
				3) Cannot determine the mirror recovery direction.	3) The mirror recovery direction cannot be determined. Perform forced mirror recovery.				
				4) The source server is abnormal.	4) The copy source server is abnormal. Check the status of the mirror agent.				
mdadm	Info	20	Initial mirror recovery was not executed following the configuration. (Device:%1)	Initial mirror construction was not performed according to the setting.	-	•	•		
mdadm	Info	21	Mirror partition mkfs was executed. (Device:%1)	mkfs of the mirror partition has been executed.	-	•	•		
mdadm	Info	22	Mirror partition mkfs was not executed following the configuration. (Device:%1)	mkfs of the mirror partition was not executed according to the setting.	-	•	•		
mdadm	Info	23	Forced mirror recovery was canceled. Execute the command "clpmdctrl --force" to resume the mirror recovery. (Device:%1)	Forced mirror recovery has been canceled. To restart the mirror recovery, execute clpmdctrl --force.	To restart the mirror recovery, execute clpmdctrl --force.	•	•		
mdadm	Warning	24	One of the servers is active, but NMP size of mirror disks are not the same. (Device:%1)	One of the servers is active. The NMP sizes do not match, however.	Execute forced mirror recovery using the active server as the mirror recovery source server.	•	•		

Module type	Event type	Event ID	Message	Description	Solution	Reported to			
						alert	syslog	mail	SNMP Trap
mdadm	Info	25	The NMP sizes of both servers' disks has been successfully synchronized. (Device:%1)	The NMP sizes of both servers have been successfully synchronized.	-	•	•		
mdadm	Error	28	Mirror recovery data has been successfully synchronized. NMP size synchronization has failed. (Device:%1)	Mirror recovery data has been successfully synchronized. However, the NMP sizes could not be synchronized.	Reexecute the forced mirror recovery.	•	•		
mdadm	Error	30	The license information was removed after the cluster was started.	The license was valid when the cluster was started. However, the license was deleted.	Register a valid license.	•	•		
mdadm	Error	31	Failed to isolate the mirror. %1 (Device: %2)	%2 could not be isolated. The following message is output to %1: 1) Replicator license is invalid or expired.	Register a valid license.	•	•		
mdadm	Error	32	Forced activation of the mirror failed. %1 (Device:%2)	Forced activation of %2 failed. The following messages may be output output to %1: 1) Failed to open I/O port. 2) Mount operation failed. 3) Replicator license is invalid or expired.	Take appropriate action according to the message displayed in %1. 1) The port could not be opened. Check the cluster configuration data. 2) The mount operation failed. Check whether the mount point exists. Alternatively, check whether the mount option of the cluster configuration data is correct. 3) Register a valid license.	•	•		
mdadm	Error	33	Forced recovery of the mirror failed. %1 (Device: %2)	Forced recovery of %2 failed. The following message may be output output to %1: 1) Replicator license is invalid or expired.	1) Register a valid license.	•	•		

Messages reported by syslog, alert, mail, and SNMP trap

Module type	Event type	Event ID	Message	Description	Solution	Reported to			
						alert	syslog	mail	SNMP Trap
mdadm	Info	34	Isolating the mirror %1 completed successfully.	Mirror resource %1 has been successfully isolated.		•	•		
mdadm	Info	35	Mirror force active of %1 was completed successfully.	Forced activation of %1 has been successful.		•	•		
mdadm	Info	36	Forced recovery of the mirror %1 completed successfully.	Forced recovery of %1 has been successful.		•	•		
mdadm	Error	37	%1 of %2 failed(ret=%3).	Command %1 of device %2 failed with return value %3.	See the manual for command %1.	•	•		
mdadm	Warning	38	Executing %1 of %2 with %3 option is necessary. Execute the command manually.	Executing command %1 of device %2 with option %3 specified is necessary. Execute the command manually.	Execute command %1 manually with option %3 specified.	•	•		
mdadm	Info	39	%1 of %2 with %3 option has started.	Command %1 of device %2 with option %3 specified has started.		•	•		
mdadm	Info	40	Failed to write to cluster partition of hybrid disk(%1).	Writing to cluster partition of %1 has failed.	Restart the server.	•	•		
mdadm	Info	41	Timeout in writing to cluster partition of hybrid disk(%1).	Writing to the cluster partition of %1 has timed out.	The disk load may be high. Increase the value of <b>Cluster Properties - Mirror Agent</b> tab - <b>Cluster Partition I/O Timeout</b> . Alternatively, increase the timeout value of the monitor resource (hdw, hdnw) along with the increase in the former value.	•	•		
mdadm	Info	42	Failed to read from cluster partition of hybrid disk(%1).	Reading of the cluster partition of %1 has failed.	Restart the server.	•	•		

Module type	Event type	Event ID	Message	Description	Solution	Reported to			
						alert	syslog	mail	SNMP Trap
mdadm	Info	43	Timeout in reading from cluster partition of hybrid disk(%1).	Reading of the cluster partition of %1 has timed out.	The disk load may be high. Increase the value of <b>Cluster Properties - Mirror Agent</b> tab - <b>Cluster Partition I/O Timeout</b> . Alternatively, increase the timeout value of the monitor resource (hdw, hdnw) along with the increase in the former value.	•	•		
mdadm	Info	44	Mirror recovery of %1 was canceled.	Mirror recovery of %1 has been canceled.	-	•	•		
mdadm	Info	45	Failed to cancel mirror recovery of %1.	Mirror recovery of %1 could not be canceled.	Stop the mirror recovery again.	•	•		
mdadm	Error	46	umount timeout. Make sure that the length of Unmount Timeout is appropriate. (Device:%1)	Unmount of mirror %1 has timed out.	Check whether the unmount timeout setting is sufficiently long. (Refer to "Notes on stopping mirror disk resources or hybrid disk resources" and "Cache swell by a massive I/O" in "Notes and Restrictions" in the <i>Getting Started Guide</i> .)	•	•		
mdadm	Error	47	fsck timeout. Make sure that the length of Fsync Timeout is appropriate. (Device:%1)	fsck that was run prior to mount of mirror %1 has timed out.	Check whether the fsck timeout setting is sufficiently long. (Refer to "fsck execution" in "Notes and Restrictions" in the <i>Getting Started Guide</i> .)	•	•		
mdagent	Info	1	The Mirror Agent has started successfully.	The mirror agent has been started normally.	-	•	•		
mdagent	Error	2	Failed to start Mirror Agent. %1	The mirror agent could not be started. The following messages may be output to %1:	Take appropriate action according to the message displayed in %1.	•	•		
				1) Agent is running.	1) The agent has already been started.				
				2) Command clpmdini is running.	2) The clpmdini command has already been started. Check the end of the command and then restart it.				

Messages reported by syslog, alert, mail, and SNMP trap

Module type	Event type	Event ID	Message	Description	Solution	Reported to			
						alert	syslog	mail	SNMP Trap
				3) IP address in the config file is invalid.	3, 4, 5) Check the cluster configuration data.				
			4) Server name in the config file is invalid.						
			5) There is an error in config file.						
				6) Failed to initialize socket server.	6) Check the following possible causes: memory shortage or OS resource insufficiency.				
				7) Disk error had occurred before reboot. Agent will stop starting..	7) Disk error occurred. Check the mirror disk and if necessary, see "How to replace a mirror disk with a new one" in Chapter 10 and replace it.				
mdagent	Info	3	The Mirror Agent has stopped successfully.	The mirror agent has been stopped normally.	-	•	•		

Module type	Event type	Event ID	Message	Description	Solution	Reported to			
						alert	syslog	mail	SNMP Trap
mdagent	Error	4	Failed to stop the Mirror Agent.	The mirror agent has failed to stop.	<p>Check the following possible causes: cluster not yet activated, memory shortage, or OS resource insufficiency.</p> <p>It is probable that an attempt to stop the mirror agent or server was made while the mirror disk resource or hybrid disk resource was activated. Use the WebManager or an EXPRESSCLUSTER command to stop the mirror agent or server. It is probable that an attempt to stop the mirror agent or server was made while the mirror disk resource or hybrid disk resource was still mounted. If an unmount timeout occurred, set a larger value for unmount timeout. If the user mounted the mirror partition at multiple mount points, unmount the additional mount point before deactivating the mirror.</p> <p>It is also probable that mirror recovery was in progress. If mirror recovery is in progress, stop the mirror agent or server after mirror recovery is completed or after stopping mirror recovery.</p>	•	•		
mdagent	Warning	5	Failed to load the resource(%1). Check if the Cluster Partition or Data Partition is OK.	Resource %1 could not be loaded.	Check whether the paths of the cluster and data partitions of resource %1 are correct or whether those paths may be destroyed.	•	•		
mdctrl hdctrl	Error	1	Failed to activate mirror disk.%1(Device:%2)	Activating %2 has failed. The following messages may be output to %1:	Take appropriate action according to the message displayed in %1.	•	•		

Messages reported by syslog, alert, mail, and SNMP trap

Module type	Event type	Event ID	Message	Description	Solution	Reported to			
						alert	syslog	mail	SNMP Trap
				1) Failed to open I/O port.	1) The port could not be opened. Check the cluster configuration data.				
				2) The local server doesn't have the latest data.	2) The local server does not have the latest data. Mirror recovery is needed.				
				3) Communication to the remote server failed.	3) Communication with a remote server failed. Check the connection status of the mirror disk connection.				
				4) The remote server is active.	4) The remote server has already been activated. Check the status of the mirror disk resource.				
				5) The local server is already active.	5) The local server has already been activated. Check the status of the mirror disk resource.				
				6) Mount operation failed.	6) The mount operation failed. Check whether the mount point exists. Alternatively, check whether the mount option of the cluster configuration data is correct.				
				7) NMP size of the local server is greater than that of the remote server.	7) The NMP size of the local server is greater than that of the remote server. Execute forced mirror recovery using the remote server as the mirror recovery source server.				
				8) Failed to set writable mode for data partition	8) Restart the server which tried to activate the resource. Note that failover may occur when the server is restarted.				
mdctrl hdctrl	Info	2	fsck of %1 has started.	fsck of %1 has started.	-	•	•		
mdctrl hdctrl	Info	3	fsck of %1 was successful.	fsck of %1 has been successful.	-	•	•		

Module type	Event type	Event ID	Message	Description	Solution	Reported to			
						alert	syslog	mail	SNMP Trap
mdctrl hdctrl	Error	4	Failed to deactivate mirror disk.%1(Device:%2)	Deactivating %2 has failed. The following messages may be output to %1:	Take appropriate action according to the message displayed in %1.	•	•		
				1) The mirror disk has already been deactivated.	1) The mirror disk has already been deactivated. Check the status of the mirror disk resource.				
				2) Unmount operation failed.	2) The unmount operation failed. Check whether the file system of the mirror disk resource is busy.				
mdctrl hdctrl	Error	5	Failed to recover mirror.%1(Device:%2)	Mirror recovery of %2 has failed. The following messages may be output to %1:	Take appropriate action according to the message displayed in %1.	•	•		
				1) The recovery is in progress.	1) Mirror recovery is in progress. Wait for the completion of the mirror recovery and then reexecute.				
				2) The destination server is active.	2) The mirror disk resource has already been activated on the copy destination server. Check the status of the mirror disk resource.				
				3) Can not judge the recovery direction.	3) The mirror recovery direction cannot be determined. Perform forced mirror recovery.				
				4) The source server is abnormal.	4) The copy source server is abnormal. Check the status of the mirror agent.				
				5) NMP size of recovery destination is smaller.	5) Execute the forced mirror recovery using the remote server as the mirror recovery source server. Alternatively, replace the mirror recovery destination disk with a disk of sufficient size or allocate a data partition of sufficient size with the fdisk command.				



Messages reported by syslog, alert, mail, and SNMP trap

Module type	Event type	Event ID	Message	Description	Solution	Reported to			
						alert	syslog	mail	SNMP Trap
mdctrl hdctrl	Info	7	Mirror recovery mode is %1.(Device:%2)	The mirror recovery mode is %1.  When %1 is "NORMAL", full-scale mirror recovery (Full Copy) is performed.  When %1 is "FAST", difference mirror recovery is performed.		•	•		
mdctrl hdctrl	Info	16	Initial mirror recovery of %1 has started.	Initial mirror construction of %1 has started.		•	•		
mdctrl hdctrl	Info	17	Mirror recovery of %1 has started.	Mirror recovery of %1 has started.		•	•		
mdctrl hdctrl	Info	18	Initial mirror recovery of %1 was successful.	Initial mirror construction of %1 has been successful.		•	•		
mdctrl hdctrl	Error	19	Failed to perform initial mirror recovery. %1(Device:%2)	Initial mirror construction of %2 has failed. The following messages may be output to %1:	Take appropriate action according to the message displayed in %1.	•	•		
				1) The recovery is in progress.	1) Mirror recovery is in progress. Wait for the completion of the mirror recovery and then reexecute.				
				2) The destination server is active.	2) The resource has already been activated on the copy destination server. Check the status of the mirror disk resource.				
				3) Cannot judge the recovery direction.	3) The mirror recovery direction cannot be determined. Perform forced mirror recovery.				
			4) The source server is abnormal.	4) The copy source server is abnormal. Check the status of the mirror agent.					
mdctrl hdctrl	Info	20	Initial mirror recovery was not executed following the configuration. (Device:%1)	Initial mirror construction was not performed according to the setting.		•	•		

Module type	Event type	Event ID	Message	Description	Solution	Reported to			
						alert	syslog	mail	SNMP Trap
mdctrl hdctrl	Error	31	Failed to isolate the mirror. %1(Device: %2)	%2 failed to be isolated. The following message may be output to %1:		•	•		
				1) Replicator license is invalid or expired.	Register a valid license.				
mdctrl hdctrl	Error	32	Forced activation of the mirror failed. %1 (Device:%2)	Forced activation of %2 failed. The following messages may be output to %1:	Take appropriate action according to the message displayed in %1.	•	•		
				1) Failed to open I/O port.	1) The port could not be opened. Check the cluster configuration data.				
				2) Mount operation failed.	2) The mount operation failed. Check whether the mount point exists. Alternatively, check whether the mount option of the cluster configuration data is correct.				
				3) Replicator license is invalid or expired.	3) Register a valid license.				
mdctrl hdctrl	Error	33	Forced recovery of the mirror failed. %1(Device:%2)	Forced recovery of %2 failed. The following messages may be output to %1:		•	•		
				1) Replicator license is invalid or expired.	1) Register a valid license.				
mdctrl hdctrl	Info	34	Isolating the mirror %1 completed successfully.	Mirror resource %1 has been successfully isolated.	-	•	•		
mdctrl hdctrl	Info	35	Mirror force active of %1 was completed successfully.	Forced activation of %1 has been successful.	-	•	•		
mdctrl hdctrl	Info	36	Forced recovery of the mirror %1 completed successfully.	Forced recovery of %1 has been successful.	-	•	•		
mdctrl hdctrl	Error	37	%1 of %2 failed(ret=%3).	Command %1 of device %2 failed with return value %3.	See the manual for command %1.	•	•		

Messages reported by syslog, alert, mail, and SNMP trap

Module type	Event type	Event ID	Message	Description	Solution	Reported to			
						alert	syslog	mail	SNMP Trap
mdctrl hdctrl	Warning	38	Executing %1 of %2 with %3 option is necessary. Execute the command manually.	Executing command %1 of device %2 with option %3 specified is necessary. Execute the command manually.	Execute command %1 manually with option %3 specified.	•	•		
mdctrl hdctrl	Info	39	%1 of %2 with %3 option has started.	Command %1 of device %2 with option %3 specified has started.	-	•	•		
mdctrl hdctrl	Info	44	Mirror recovery of %1 was canceled.	Mirror recovery of %1 has been canceled.	-	•	•		
mdctrl hdctrl	Info	45	Failed to cancel mirror recovery of %1.	Mirror recovery of %1 could not be canceled.	Stop the mirror recovery again.	•	•		
mdctrl hdctrl	Error	46	umount timeout. Make sure that the length of Unmount Timeout is appropriate. (Device:%1)	Unmount of mirror %1 has timed out.	Check whether the unmount timeout setting is sufficiently long. (Refer to "Notes on stopping mirror disk resources or hybrid disk resources" and "Cache swell by a massive I/O" in "Notes and Restrictions" in the <i>Getting Started Guide</i> .)	•	•		
mdctrl hdctrl	Error	47	fsck timeout. Make sure that the length of Fck Timeout is appropriate. (Device:%1)	fsck that was run prior to mount of mirror %1 has timed out.	Check whether the fsck timeout setting is sufficiently long. (Refer to "fsck execution" in "Notes and Restrictions" in the <i>Getting Started Guide</i> .)	•	•		
mdinit hdinit	Info	21	Mirror partition mkfs was executed. (Device:%1)	mkfs of the mirror partition has been executed.	-	•	•		
mdinit hdinit	Info	22	Mirror partition mkfs was not executed following the configuration. (Device:%1)	mkfs of the mirror partition was not executed according to the setting.	-	•	•		
mdw hdw	Error	5	Failed to recover the mirror.%1(Device:%2)	Mirror recovery of %2 has failed. The following messages may be output to %1:	Take appropriate action according to the message displayed in %1.	•	•		

Module type	Event type	Event ID	Message	Description	Solution	Reported to			
						alert	syslog	mail	SNMP Trap
				<p>1) The recovery is in progress.</p> <p>2) The destination server is active.</p> <p>3) Cannot determine the mirror recovery direction.</p> <p>4) The source server is abnormal.</p> <p>5) NMP size of recovery destination is smaller.</p>	<p>1) An attempt was made to start auto mirror recovery, but mirror recovery was already started.</p> <p>2) The mirror disk resource has already been activated on the copy destination server. Check the status of the mirror disk resource.</p> <p>3) The mirror recovery direction cannot be determined. Perform forced mirror recovery.</p> <p>4) The copy source server is abnormal. Check the status of the mirror agent.</p> <p>5) Execute the forced mirror recovery using the remote server as the mirror recovery source server. Alternatively, replace the mirror recovery destination disk with a disk of sufficient size or allocate a data partition of sufficient size with the fdisk command.</p>				
mdw hdw	Info	7	Mirror recovery mode is %1.(Device:%2)	<p>The mirror recovery mode is %1.</p> <p>When %1 is "NORMAL", full-scale mirror recovery (Full Copy) is performed.</p> <p>When %1 is "FAST", difference mirror recovery is performed.</p>	-	•	•		
mdw hdw	Info	16	Initial mirror recovery of %1 has started.	Initial mirror construction of %1 has started.	-	•	•		
mdw hdw	Info	17	Mirror recovery of %1 has started.	Mirror recovery of %1 has started.	-	•	•		
mdw hdw	Info	18	Initial mirror recovery of %1 was successful.	Initial mirror construction of %1 has been successful.	-	•	•		

Messages reported by syslog, alert, mail, and SNMP trap

Module type	Event type	Event ID	Message	Description	Solution	Reported to			
						alert	syslog	mail	SNMP Trap
mdw hdw	Error	19	Failed to perform initial mirror recovery.%1(Device:%2)	Initial mirror construction of %2 has failed. The following messages may be output to %1:	Take appropriate action according to the message displayed in %1.	•	•		
				1) The recovery is in progress.	1) Mirror recovery is in progress. Wait for the completion of the mirror recovery and then reexecute.				
				2) The destination server is active.	2) The resource has already been activated on the copy destination server. Check the status of the mirror disk resource.				
				3) Cannot determine the mirror recovery direction.	3) The mirror recovery direction cannot be determined. Perform forced mirror recovery.				
				4) The source server is abnormal.	4) The copy source server is abnormal. Check the status of the mirror agent.				
mdw hdw	Info	20	Initial mirror recovery was not executed following the configuration. (Device:%1)	Initial mirror construction was not performed according to the setting.	-	•	•		
fip	Error	10	IP address %1 already exists on the network.	IP address %1 exists in the network.	Check whether the IP address is already in use in the network.	•	•		
fip	Info	11	IP address %1 will be forcefully activated.	IP address %1 is forcibly activated.	-	•	•		
vip	Error	10	IP address %1 already exists on the network.	IP address %1 exists in the network.	Check whether the IP address is already in use in the network.	•	•		
vip	Info	11	IP address %1 will be forcefully activated.	IP address %1 is forcibly activated.	-	•	•		
disk	Info	10	%1 of %2 has started.	Command %1 of device %2 has started.	-	•	•		
disk	Info	11	%1 of %2 was successful.	Command %1 of device %2 has been successful.	-	•	•		

Module type	Event type	Event ID	Message	Description	Solution	Reported to			
						alert	syslog	mail	SNMP Trap
disk	Error	12	%1 of %2 failed (ret=%3).	Command %1 of device %2 failed with return value %3.	See the manual for command %1.	•	•		
disk	Warning	13	Executing %1 of %2 with %3 option is necessary. Execute the command manually.	Executing command %1 of device %2 with option %3 specified is necessary. Execute the command manually.	Execute command %1 manually with option %3 specified.	•	•		
disk	Info	14	%1 of %2 with %3 option has started.	Command %1 of device %2 with option %3 specified has started.	-	•	•		
disk	Error	15	Timeout occurred during %1 of %2.	Execution of Command %1 of device %2 has timed out.	Check the cause of the execution timeout of Command %1 and take appropriate action.	•	•		
cl	Info	1	There was a request to start %1 from the %2.	A request to start %1 was issued from %2.	-	•	•		
cl	Info	2	There was a request to stop %1 from the %2.	A request to stop %1 was issued from %2.	-	•	•		
cl	Info	3	There was a request to suspend %1 from the %2.	A request to suspend %1 was issued from %2.	-	•	•		
cl	Info	4	There was a request to resume %s from the %s.	A request to resume %s was issued from %2.	-	•	•		
cl	Error	11	A request to start %1 failed(%2).	A request to start %1 has failed.	Check the status of the cluster.	•	•		
cl	Error	12	A request to stop %1 failed(%2).	A request to stop %1 has failed.	Check the status of the cluster.	•	•		
cl	Error	13	A request to suspend %1 failed(%2).	A request to suspend %1 has failed.	Check the status of the cluster.	•	•		
cl	Error	14	A request to resume %1 failed(%2).	A request to resume %1 has failed.	Check the status of the cluster.	•	•		
cl	Error	15	A request to %1 cluster failed on some servers(%2).	A %1 request of the cluster failed on some servers.	Check the status of the cluster.	•	•		
cl	Error	16	A request to start %1 failed on some servers(%2).	Starting %1 failed on some servers.	Check the status of %1.	•	•		

Messages reported by syslog, alert, mail, and SNMP trap

Module type	Event type	Event ID	Message	Description	Solution	Reported to			
						alert	syslog	mail	SNMP Trap
cl	Error	17	A request to stop %1 failed on some servers(%2).	Stopping %1 failed on some servers.	Check the status of %1.	•	•		
cl	Warning	18	Automatic start is suspended because the cluster service was not stopped according to the normal procedure.	Automatic start has been suspended because <b>Automatic startup after the system down</b> was not set.	To start the cluster service, use the WebManager or clpcl command.	•	•		
cl	Warning	20	A request to start %1 failed because cluster is running(%2).	Starting %1 has failed because the cluster is running.	Check the status of the cluster.	•	•		
cl	Warning	21	A request to stop %1 failed because cluster is running(%2).	Stopping %1 has failed because the cluster is running.	Check the status of the cluster.	•	•		
mail	Error	1	The license is not registered. (%1)	Purchase the license and then register it.	-	•	•		
mail	Error	2	The trial license has expired in %1. (%2)	Register a valid license.	-	•	•		
mail	Error	3	The registered license is invalid. (%1)	Register a valid license.	-	•	•		
mail	Error	4	The registered license is unknown. (%1)	Register a valid license.	-	•	•		
mail	Error	5	mail failed(%s).(SMTP server: %s)	Mail report failed.	Check whether there is an error in the SMTP server and that there is no problem with communicating with the SMTP server.	•	•		
mail	Info	6	mail succeeded.(SMTP server: %s)	Mail report has been successful.	-	•	•		
userw	Warning	1	Detected a monitor delay in monitoring %1. (timeout=%2*%3 actual-time=%4 delay warning rate=%5)	A monitoring delay was detected in monitoring %1. The current timeout value is %2 (second) x %3 (tick count per second). The actual measurement value at delay detection is %4 (tick count) and exceeded the delay warning rate %5 (%).	Check the load condition of the server on which the monitoring delay was detected, and lessen the load appropriately.  If a monitoring timeout is likely to be detected, you should increase the monitoring timeout setting.	•	•		

Module type	Event type	Event ID	Message	Description	Solution	Reported to			
						alert	syslog	mail	SNMP Trap
vipw	Warning	1	Detected a monitor delay in monitoring %1. (timeout=%2*%3 actual-time=%4 delay warning rate=%5)	A monitoring delay was detected in monitoring %1. The current timeout value is %2 (second) x %3 (tick count per second). The actual measurement value at delay detection is %4 (tick count) and exceeded the delay warning rate %5 (%).	Check the load condition of the server on which the monitoring delay was detected, and lessen the load appropriately.  If a monitoring timeout is likely to be detected, you should increase the monitoring timeout setting.	•	•		
ddnsw	Warning	1	Detected a monitor delay in monitoring %1. (timeout=%2*%3 actual-time=%4 delay warning rate=%5)	A monitoring delay was detected in monitoring %1. The current timeout value is %2 (second) x %3 (tick count per second). The actual measurement value at delay detection is %4 (tick count) and exceeded the delay warning rate %5 (%).	Check the load condition of the server on which the monitoring delay was detected, and lessen the load appropriately.  If a monitoring timeout is likely to be detected, you should increase the monitoring timeout setting.	•	•		
vmw	Warning	1	Detected a monitor delay in monitoring %1. (timeout=%2*%3 actual-time=%4 delay warning rate=%5)	A monitoring delay was detected in monitoring %1. The current timeout value is %2 (second) x %3 (tick count per second). The actual measurement value at delay detection is %4 (tick count) and exceeded the delay warning rate %5 (%).	Check the load condition of the server on which the monitoring delay was detected, and lessen the load appropriately.  If a monitoring timeout is likely to be detected, you should increase the monitoring timeout setting.	•	•		
bmcw	Warning	1	Detected a monitor delay in monitoring %1. (timeout=%2*%3 actual-time=%4 delay warning rate=%5)	A monitoring delay was detected in monitoring %1. The current timeout value is %2 (second) x %3 (tick count per second). The actual measurement value upon delay detection is %4 (tick count) which exceeds the delay warning rate %5 (%).	Check the load status of the server on which a monitoring delay was detected and then remove that load. If a monitoring timeout is likely to be detected, increase the monitoring timeout setting.	•	•		
apisv	Info	1	There was a request to stop cluster from the %1(IP=%2).	A request to stop the cluster was issued from %1.	-	•	•		



Messages reported by syslog, alert, mail, and SNMP trap

Module type	Event type	Event ID	Message	Description	Solution	Reported to			
						alert	syslog	mail	SNMP Trap
apisv	Info	2	There was a request to shutdown cluster from the %1(IP=%2).	A request to shut down the cluster was issued from %1.		•	•		
apisv	Info	3	There was a request to reboot cluster from the %1(IP=%2).	A request to reboot the cluster was issued from %1.		•	•		
apisv	Info	4	There was a request to suspend cluster from the %1(IP=%2).	A request to suspend the cluster was issued from %1.		•	•		
apisv	Info	10	There was a request to stop server from the %1(IP=%2).	A request to stop the server was issued from %1.		•	•		
apisv	Info	11	There was a request to shutdown server from the %1(IP=%2).	A request to shut down the server was issued from %1.		•	•		
apisv	Info	12	There was a request to reboot server from the %1(IP=%2).	A request to reboot the server was issued from %1.		•	•		
apisv	Info	13	There was a request to server panic from the %1(IP=%2).	A server panic request was issued from %1.		•	•		
apisv	Info	14	There was a request to server reset from the %1(IP=%2).	A server reset request was issued from %1.		•	•		
apisv	Info	15	There was a request to server sysrq from the %1(IP=%2).	An SYSRQ panic request was issued from %1.		•	•		
apisv	Info	16	There was a request to KA RESET from the %1(IP=%2).	A keepalive reset request was issued from %1.		•	•		
apisv	Info	17	There was a request to KA PANIC from the %1(IP=%2).	A keepalive panic request was issued from %1.		•	•		

Module type	Event type	Event ID	Message	Description	Solution	Reported to			
						alert	syslog	mail	SNMP Trap
apisv	Info	18	There was a request to BMC reset from the %1(IP=%2).	A BMC reset request was issued from %1.	-	•	•		
apisv	Info	19	There was a request to BMC PowerOff from the %1(IP=%2).	A BMC power-off request was issued from %1.	-	•	•		
apisv	Info	20	There was a request to BMC PowerCycle from the %1(IP=%2).	A BMC power cycle request was issued from %1.	-	•	•		
apisv	Info	21	There was a request to BMC NMI from the %1(IP=%2).	A BMC NMI request was issued from %1.	-	•	•		
apisv	Info	22	There was a request to IO Fencing from the %1(IP=%2).	An I/O fencing request was received from %1.	-	•	•		
apisv	Info	30	There was a request to start group(%1) from the %2(IP=%3).	A request to start group %1 was issued from %2.	-	•	•		
apisv	Info	31	There was a request to start all groups from the %1(IP=%2).	A request to start all groups was issued from %1.	-	•	•		
apisv	Info	32	There was a request to stop group(%1) from the %2(IP=%3).	A request to stop group %1 was issued from %2.	-	•	•		
apisv	Info	33	There was a request to stop all groups from the %1(IP=%2).	A request to stop all groups was issued from %1.	-	•	•		
apisv	Info	34	There was a request to restart group(%1) from the %2(IP=%3).	A request to restart group %1 was issued from %2.	-	•	•		
apisv	Info	35	There was a request to restart all groups from the %1(IP=%2).	A request to restart all groups was issued from %1.	-	•	•		
apisv	Info	36	There was a request to move group(%1) from the %2(IP=%3).	A request to move group %1 was issued from %2.	-	•	•		

Messages reported by syslog, alert, mail, and SNMP trap

Module type	Event type	Event ID	Message	Description	Solution	Reported to			
						alert	syslog	mail	SNMP Trap
apisv	Info	37	There was a request to move all groups from the %1(IP=%2).	A request to move the group was issued from %1.	-	•	•		
apisv	Info	38	There was a request to failover group(%1) from the %2(IP=%3).	A group %1 failover request was issued from %2.	-	•	•		
apisv	Info	39	There was a request to failover all groups from the %1(IP=%2).	A group failover request was issued from %1.	-	•	•		
apisv	Info	40	There was a request to migrate group(%1) from the %2(IP=%3).	A group %1 migration request was issued from %2.	-	•	•		
apisv	Info	41	There was a request to migrate all groups from the %1(IP=%2).	A request to make all groups migrate was issued from %2.	-	•	•		
apisv	Info	42	There was a request to failover all groups from the %1(IP=%2).	A request to provide failover for all groups was issued from %2.	-	•	•		
apisv	Info	43	There was a request to cancel waiting for the dependence destination group of group the %1 was issued from %2.	A request to cancel waiting for the dependence destination group of group %1 was issued from %2.	-	•	•		
apisv	Info	50	There was a request to start resource(%1) from the %2(IP=%3).	A request to start resource %1 was issued from %2.	-	•	•		
apisv	Info	51	There was a request to start all resources from the %1(IP=%2).	A request to start all resources was issued from %1.	-	•	•		
apisv	Info	52	There was a request to stop resource(%1) from the %2(IP=%3).	A request to stop resource %1 was issued from %2.	-	•	•		
apisv	Info	53	There was a request to stop all resources from the %1(IP=%2).	A request to stop all resources was issued from %1.	-	•	•		

Module type	Event type	Event ID	Message	Description	Solution	Reported to			
						alert	syslog	mail	SNMP Trap
apisv	Info	54	There was a request to restart resource(%1) from the %2(IP=%3).	A request to restart resource %1 was issued from %2.	-	•	•		
apisv	Info	55	There was a request to restart all resources from the %1(IP=%2).	A request to restart all resources was issued from %1.	-	•	•		
apisv	Info	60	There was a request to suspend monitor resources from the %1(IP=%2).	A request to suspend the monitor resource was issued from %1.	-	•	•		
apisv	Info	61	There was a request to resume monitor resources from the %1(IP=%2).	A request to resume the monitor resource was issued from %1.	-	•	•		
apisv	Info	62	There was a request to enable Dummy Failure of monitor resource(%1) from the %2(IP=%3).	A request to enable Dummy Failure of monitor resource %1 was issued from %2.	-	•	•		
apisv	Info	63	There was a request to disable Dummy Failure of monitor resource(%1) from the %2(IP=%3).	A request to disable Dummy Failure of monitor resource %1 was issued from %2.	-	•	•		
apisv	Info	64	There was a request to disable Dummy Failure of all monitor resources from the %1(IP=%2).	A request to disable Dummy Failure of all the monitor resources was issued from %1.	-	•	•		
apisv	Info	70	There was a request to set CPU frequency from the %1(IP=%2).	A request to set the CPU clock was issued from %1.	-	•	•		
apisv	Error	101	A request to stop cluster was failed(0x%08x).	The cluster could not be stopped.	Check the status of the cluster.	•	•		
apisv	Error	102	A request to shutdown cluster was failed(0x%08x).	The cluster could not be shut down.	Check the status of the cluster.	•	•		
apisv	Error	103	A request to reboot cluster was failed(0x%08x).	The cluster could not be rebooted.	Check the status of the cluster.	•	•		

Messages reported by syslog, alert, mail, and SNMP trap

Module type	Event type	Event ID	Message	Description	Solution	Reported to			
						alert	syslog	mail	SNMP Trap
apisv	Error	104	A request to suspend cluster was failed(0x%08x).	The cluster could not be suspended.	Check the status of the cluster.	•	•		
apisv	Error	110	A request to stop server was failed(0x%08x).	The server could not be stopped.	Check the status of the server.	•	•		
apisv	Error	111	A request to shutdown server was failed(0x%08x).	The server could not be shut down.	Check the status of the server.	•	•		
apisv	Error	112	A request to reboot server was failed(0x%08x).	The server could not be rebooted.	Check the status of the server.	•	•		
apisv	Error	113	A request to server panic was failed(0x%08x).	Server panic has failed.	Check the status of the server.	•	•		
apisv	Error	114	A request to server reset was failed(0x%08x).	Server reset has failed.	Check the status of the server.	•	•		
apisv	Error	115	A request to server sysrq was failed(0x%08x).	SYSRQ panic has failed.	Check the status of the server.	•	•		
apisv	Error	116	A request to KA RESET was failed(0x%08x).	Keepalive reset has failed.	Check the status of the server.	•	•		
apisv	Error	117	A request to KA PANIC was failed(0x%08x).	Keepalive panic has failed.	Check the status of the server.	•	•		
apisv	Error	118	A request to BMC RESET was failed(0x%08x).	BMC reset has failed.	Check the status of the server.	•	•		
apisv	Error	119	A request to BMC PowerOff was failed(0x%08x).	BMC power-off has failed.	Check the status of the server.	•	•		
apisv	Error	120	A request to BMC PowerCycle was failed(0x%08x).	BMC power cycle has failed.	Check the status of the server.	•	•		
apisv	Error	121	A request to BMC NMI was failed(0x%08x).	BMC NMI has failed.	Check the status of the server.	•	•		
apisv	Error	122	A request to IO Fencing was failed(0x%08x).	I/O fencing has failed.	Check the status of the server.	•	•		
apisv	Error	130	A request to start group(%1) was failed(0x%08x).	Starting group (%1) has failed.	Take appropriate action according to the group start failure message issued by rc.	•	•		

Module type	Event type	Event ID	Message	Description	Solution	Reported to			
						alert	syslog	mail	SNMP Trap
apisv	Error	131	A request to start all groups was failed(0x%08x).	Starting all groups has failed.	Same as above.	•	•		
apisv	Error	132	A request to stop group(%1) was failed(0x%08x).	Stopping group (%1) has failed.	Take appropriate action according to the group stop failure message issued by rc.	•	•		
apisv	Error	133	A request to stop all groups was failed(0x%08x).	Stopping all groups has failed.	Same as above.	•	•		
apisv	Error	134	A request to restart group(%1) was failed(0x%08x).	Restarting group (%1) has failed.	Take appropriate action according to the group stop failure message issued by rc.	•	•		
apisv	Error	135	A request to restart all groups was failed(0x%08x).	Restarting all groups has failed.	Same as above.	•	•		
apisv	Error	136	A request to move group(%1) was failed(0x%08x).	Moving group (%1) has failed.	Take appropriate action according to the group movement failure message issued by rc.	•	•		
apisv	Error	137	A request to move all groups was failed(0x%08x).	Moving all groups has failed.	Same as above.	•	•		
apisv	Error	138	A request to failover group(%1) was failed(0x%08x).	Failover for group (%1) has failed.	Take appropriate action according to the group failover failure message issued by rc.	•	•		
apisv	Error	139	A request to failover all groups was failed(0x%08x).	Failover for all groups has failed.	Same as above.	•	•		
apisv	Error	140	A request to migrate group(%1) was failed(0x%08x).	Migration of group (%1) has failed.	Take appropriate action according to the group failover failure message issued by rc.	•	•		
apisv	Error	141	A request to migrate all groups was failed(0x%08x).	Migration of all groups has failed.	Same as above.	•	•		
apisv	Error	142	A request to failover all groups was failed(0x%08x).	Failover for all groups has failed.	Same as above.	•	•		
apisv	Error	143	A request to cancel waiting for the dependency destination group of group %1 has failed(0x%08x).	Canceling waiting for the dependency destination group of group %1 has failed.	Same as above.	•	•		

Messages reported by syslog, alert, mail, and SNMP trap

Module type	Event type	Event ID	Message	Description	Solution	Reported to			
						alert	syslog	mail	SNMP Trap
apisv	Error	150	A request to start resource(%1) was failed(0x%08x).	Resource (%1) has failed to start.	Take appropriate action according to the resource start failure message issued by rc.	•	•		
apisv	Error	151	A request to start all resources was failed(0x%08x).	Starting all resources has failed.	Same as above.	•	•		
apisv	Error	152	A request to stop resource(%1) was failed(0x%08x).	Resource (%1) has failed to stop.	Take appropriate action according to the resource stop failure message issued by rc.	•	•		
apisv	Error	153	A request to stop all resources was failed(0x%08x).	Stopping all resources has failed.	Same as above.	•	•		
apisv	Error	154	A request to restart resource(%1) was failed(0x%08x).	Resource (%1) has failed to restart.	Take appropriate action according to the resource restart failure message issued by rc.	•	•		
apisv	Error	155	A request to restart all resources was failed(0x%08x).	Restarting all resources has failed.	Same as above.	•	•		
apisv	Error	160	A request to suspend monitor resource was failed(0x%08x).	The monitor resource could not be suspended.	Check the status of the monitor resource.	•	•		
apisv	Error	161	A request to resume monitor resource was failed(0x%08x).	The monitor resource could not be resumed.	Same as above.	•	•		
apisv	Error	162	A request to enable Dummy Failure of monitor resource(%1) was failed(0x%08x).	The monitor resource %1 failed to start Dummy Failure.	Check the status of the monitor resource.	•	•		
apisv	Error	163	A request to disable Dummy Failure of monitor resource(%1) was failed(0x%08x).	The monitor resource %1 failed to stop Dummy Failure.	Same as above.	•	•		
apisv	Error	164	A request to disable Dummy Failure of all monitor resources was failed(0x%08x).	All the monitor resources failed to stop Dummy Failure.	Same as above.	•	•		
apisv	Error	170	A request to set CPU frequency was failed(0x%08x).	The CPU clock level could not be set.	Take appropriate action according to the CPU clock level setting failure message issued by rc.	•	•		

Module type	Event type	Event ID	Message	Description	Solution	Reported to			
						alert	syslog	mail	SNMP Trap
lamp	Error	1	The license is not registered. (%1)	The license is not registered.	Purchase the license and then register it.	•	•		
lamp	Error	2	The trial license has expired in %1. (%2)	The validity term of the trial license has expired.	Register a valid license.	•	•		
lamp	Error	3	The registered license is invalid. (%1)	The registered license is invalid.	Register a valid license.	•	•		
lamp	Error	4	The registered license is unknown. (%1)	The registered license is unknown.	Register a valid license.	•	•		
lamp	Info	5	Notice by the network warning light succeeded.	Report by the network warning light has been successful.	-	•	•		
lamp	Error	6	Error in executing result of warning light command.(%d)	An error occurred during execution of the network warning light report command.	Take appropriate action according to the error code.	•	•		
lamp	Error	7	Failed to execute warning light command.(%d)	The network warning light report command could not be executed.	Check the following possible causes: memory shortage or OS resource insufficiency.	•	•		
cfmgr	Info	1	The cluster configuration data has been uploaded by %1.	Cluster configuration data has been uploaded.	-	•	•		
sra	Info	201	A script was executed. (%1) %1:Script name	Script (%1) has been executed.	-		•		
sra	Info	202	Running a script finished. (%1) %1:Script name	Script has ended normally.	-		•		
sra	Info	203	An %1 event succeeded. %1:Executed event type	The operation management command has been executed.  The executed event type (boot, shutdown, stop, start, or flush) is output.	-		•		
sra	Error	301	A process resource error was detected. (type = %1, pid = %2, %3) %1: Resoruce type %2: Process ID %3: Process name	A process resource error was detected.	Check the possible causes of the monitoring failure.	•	•		



Messages reported by syslog, alert, mail, and SNMP trap

Module type	Event type	Event ID	Message	Description	Solution	Reported to			
						alert	syslog	mail	SNMP Trap
sra	Error	302	A system resource error was detected. (type = %1) %1: Resource type	A system resource error was detected.	Check the possible causes of the monitoring failure.	•	•		
sra	Error	303	A system resource error was detected. (type = %1, user name = %2) %1: Resource type %2: User name	A system resource error was detected.	Check the possible causes of the monitoring failure.	•	•		
sra	Error	304	A disk resource error was detected. (type = %1, level = %2, %3) %1: Resource type %2: Monitor level %3: Mountpoint name	A disk resource error was detected.	Check the possible causes of the monitoring failure.	•	•		
sra	Warning	101	Opening an SG file failed. file name = %1, errno = %2 %1:File name %2:errno	The SG file (%1) failed to be opened.	Recreate the SG file and restart the cluster, or execute the suspend and resume.		•		
sra	Warning	102	malloc(3) fail(1) . [%1] %1:Function name	An external error has occurred.	Check the following possible causes: memory shortage or OS resource insufficiency.		•		
sra	Warning	103	malloc(3) fail(2). [%1] %1:Function name	An external error has occurred.	Check the following possible causes: memory shortage or OS resource insufficiency.		•		
sra	Warning	104	An internal error occurred. rename(2) error (errno = %1) %1:errno	This product has terminated abnormally.	See the most recently issued system log message.		•		
sra	Warning	105	realloc(3) fail. [%1]. %1:Function name	An external error has occurred.	Check the following possible causes: memory shortage or OS resource insufficiency.		•		
sra	Warning	106	A script timed out. (%1 %2) %1:Script file name %2:Argument	An external error has occurred.	Check the load status of the server and remove the load.		•		

Module type	Event type	Event ID	Message	Description	Solution	Reported to			
						alert	syslog	mail	SNMP Trap
sra	Warning	107	[%1] execvp(2) fail (%2). %1:Script file name %2:errno	An external error has occurred.	Check the following possible causes: memory shortage or OS resource insufficiency.		•		
sra	Warning	108	[%1] fork fail (%2). Suspended. %1:Script file name %2:errno	An external error has occurred.	Check the following possible causes: memory shortage or OS resource insufficiency.		•		
sra	Warning	109	malloc(3) fail. [%1] %1:Function name	An external error has occurred.	Check the following possible causes: memory shortage or OS resource insufficiency.		•		
sra	Error	1	system monitor closed because reading the SG file failed.	An error occurred in reading the SG file.	Check the message separately issued.		•		
sra	Error	2	Opening an ignore file failed. file name = %1, errno = %2. %1:File name %2:errno	The SG file (%1) failed to be opened.	Restart the cluster, or execute the suspend and resume.		•		
sra	Error	3	Reading a configuration file failed.	An error occurred in reading the SG file.	Check the message separately issued.		•		
sra	Error	4	Trace log initialization failed.	The internal log file could not be initialized.	Restart the cluster, or execute the suspend and resume.		•		
sra	Error	5	Creating a daemon process failed.	An external error has occurred.	Check the following possible causes: memory shortage or OS resource insufficiency.		•		
sra	Error	6	Reading a service configuration file failed.	An error occurred in reading the SG file.	Check the message separately issued.		•		
sra	Error	7	mlock() failed.	An external error has occurred.	Check the following possible causes: memory shortage or OS resource insufficiency.		•		
sra	Error	8	A daemon process could not be created.	SystemResourceAgent has failed to start (turning the process into a daemon).	Check the following possible causes: memory shortage or OS resource insufficiency.		•		

Messages reported by syslog, alert, mail, and SNMP trap

Module type	Event type	Event ID	Message	Description	Solution	Reported to			
						alert	syslog	mail	SNMP Trap
sra	Error	9	stdio and stderr could not be closed.	SystemResourceAgent has failed to start (closing the standard I/O).	Check the following possible causes: memory shortage or OS resource insufficiency.		•		
sra	Error	10	A signal mask could not be set up.	SystemResourceAgent has failed to start (setting the signal mask).	Check the following possible causes: memory shortage or OS resource insufficiency.		•		
sra	Error	11	A configuration file error occurred. (1) [line = %1, %2] %1:Line %2:Setting value	SystemResourceAgent has failed to start (reading the SG file).	Restart the cluster, or execute the suspend and resume.		•		
sra	Error	12	A configuration file error occurred. (2) [line=%1, %2] %1:Line %2:Setting value	SystemResourceAgent has failed to start (reading the SG file).	Restart the cluster, or execute the suspend and resume.		•		
sra	Error	13	A plugin event configuration file error occurred. The DLL pointer was not found. [line = %1, %2] %1:Line %2:Setting value	SystemResourceAgent has failed to start (registering the plugin event).	Restart the cluster, or execute the suspend and resume.		•		
sra	Error	14	malloc failed. [event structure]	SystemResourceAgent has failed to start (registering the plugin event).	Restart the cluster, or execute the suspend and resume.		•		
sra	Error	15	A service configuration file error occurred due to an invalid event. [%1] %1:Setting value	SystemResourceAgent has failed to start (reading the service file).	Restart the cluster, or execute the suspend and resume.		•		
sra	Error	16	A plugin event configuration file error occurred due to %1. %1:Cause of error	SystemResourceAgent has failed to start (reading the plugin event file).	Restart the cluster, or execute the suspend and resume.		•		
sra	Error	17	Internal error occurred.	A shared memory access error has occurred.	-		•		

Module type	Event type	Event ID	Message	Description	Solution	Reported to			
						alert	syslog	mail	SNMP Trap
jra	Info	1	%1: The JVM status changed to normal.	The status of Java VM to be monitored is normal. %1: Name of the Java VM to be monitored	-		•	•	
jra	Error	2	%1: The JVM status changed to abnormal. cause = %2.	The status of Java VM to be monitored is abnormal. %1: Name of the Java VM to be monitored %2: Error generation location at abnormality occurrence	Review the Java application that runs on Java VM to be monitored.		•	•	
jra	Error	3	%1: Connecting to JVM was not possible.	Connection to Java VM to be monitored is invalid. %1: Name of the Java VM to be monitored	Check that Java VM to be monitored is running.		•	•	
jra	Warning	4	Writing jragent.log failed. %1,code = %2.	An error occurred in writing the log file. %1: Exception contents %2: Error code	Check whether the disk free space is sufficient.		•		
jra	Warning	5	Opening jragent.log failed.	An error occurred in opening the log file.	Check whether the disk free space is sufficient.		•		
jra	Warning	6	%1: Creating a monitor status file failed.	An error occurred in creating a file. %1: Name of the Java VM to be monitored	Check whether the disk free space and the maximum number of volume files are sufficient.		•		
jra	Warning	7	%1: Deleting a monitor status file failed.	An error occurred in deleting a file. %1: Name of the Java VM to be monitored	Check whether there is a problem with the hard disk.		•		
jra	Info	8	JRAgent was started.	Java Resource Agent has started.	-		•		
jra	Error	9	Setting is wrong.[Java install path]	The Java install path is invalid.	Check the cluster configuration data.		•		

## Driver syslog messages

The syslog messages by EXPRESSCLUSTER driver in this version are output as follows:

```
[Event class] <type: Module type><event: Event ID> Message
```

Item	Display content / Description	
Event class	I	Information/Notification
	W	Warning/Caution
	E	Error
Module type	liscal	Mirror Driver
	clpkhb	Kernel Mode LAN Heartbeat Driver
	clpka	Keepalive Driver
Event ID	Digit	
Message	Message	

(Examples of display message)

```
kernel: [I] <type: liscal><event: 101> Registered blkdev with major=218.
kernel: [I] <type: liscal><event: 130> NMP1 new thread: liscal_hb_client
_thread (PID=30777).
kernel: [I] <type: liscal><event: 243> NMP1 network is USING 192.168.10.
100 - 192.168.10.101 ;29031(HB)
kernel: [W] <type: liscal><event: 220> NMP1 failed to create HB client so
cket. (err=-111: Connection refused)
kernel: [I] <type: clpkhb><event: 101> Kernel Heartbeat was initialized
successfully. (major=10, minor=240)
kernel: [E] <type: clpkhb><event: 123> Failed to bind HB socket. (err=-9
9: Can not assign requested address)
```

The messages are displayed under the following log level when outputting syslog.

Module Type		liscal	clpkhb	clpka
Type	Information/ Notification [I]	KERN_INFO	KERN_INFO	KERN_INFO
	Warning/ Caution [W]	KERN_INFO	KERN_INFO	KERN_INFO
	Error [E]	KERN_ERR	KERN_INFO	KERN_INFO

See also the followings for the coping process to the messages:

- EXPRESSCLUSTER X 3.3 Getting Started Guide Chapter 5 Notes and Restrictions
- EXPRESSCLUSTER X 3.3 Reference Guide Chapter 11 Troubleshooting
- EXPRESSCLUSTER X 3.3 Reference Guide Chapter 10 The system maintenance information

## Mirror Driver

Module Type	Event type	Event ID	Message	Description	Solution
liscal	Info	101	Registered blkdev with major=%1.	Successfully loaded the mirror driver.	-
liscal	Error	102	Failed to register blkdev with major=%1.	Failed to load the mirror driver.	-
liscal	Info	103	Unregistered blkdev with major=%1.	Successfully unloaded the mirror driver.	-
liscal	Warning	104	Failed to unregister blkdev with major=%1.	Unloading the mirror driver failed.	-
liscal	Info	110	Adding disk NMP%1 with major=%2 minor=%3.	The mirror partition NMP[%1] is going to be added.	
liscal	Info	111	Deleting disk NMP%1 with major=%2 minor=%3.	The mirror partition NMP[%1] is going to be deleted.	
liscal	Info	112	Cleaning up NMP%1 queue.	The queue of the mirror partition NMP[%1] is going to be Cleaned up.	
liscal	Error	120	insmod did not pass %1 to liscal with %2.	Loading the mirror driver failed. Invalid parameter had been specified.	Restart the local server.
liscal	Error	121	Failed to create a proc file %1.	Creation of proc file [%1] (liscalstat / liscalinner) failed.	Execute the after-mentioned <b>†coping process 1</b> (coping process to lack of resource).
liscal	Info	122	%1 is busy. (proc->count=%2)	The proc file [%1] (liscalstat / liscalinner) is being accessed. Waiting for the end of the access.	Check if there is any process accessing to [%1] (/proc/liscalstat or /proc/liscalinner). The corresponding process is going to be killed.
liscal	Info	123	Forced to remove %1 after waiting %2 seconds.	The proc file[%1] (liscalstat / liscalinner) was deleted forcibly, because killing forcibly all the processes accessing it after waiting for [%2] seconds failed.	-
liscal	Warning	124	NMP%1 waited for all I/O requests to be sent completely, but timeout occurred. Writing differences to bitmap.	Some asynchronous data could not be sent completely in time at deactivation. Their difference information is going to be written to the Cluster Partition.	-
liscal	Warning	125	NMP%1 %2 I/O requests (%3B) %4 not be sent to remote server %5.	The number of I/O requests for which the completion of asynchronization data transmission was not checked is [%2] ([%3] bytes).	-
liscal	Info	130	New thread: %2 (PID=%3).	The thread [%2] started. Process id of it is [%3].	-
			NMP%1 new thread: %2 (PID=%3).		

Module Type	Event type	Event ID	Message	Description	Solution
liscal	Error	131	Failed to fork thread: %2 (err=%3). NMP%1 failed to fork thread: %2 (err=%3).	Starting the thread [%2] failed. (Error code=[%3])	Execute the after-mentioned † <b>coping process 1</b> (coping process to lack of resource).
liscal	Info	132	killing thread.....OK. (%2) NMP%1 killing thread.....OK (%2)	Thread [%2] ended normally.	-
liscal	Info	133	%1 waiting %2 killed.....	Thread [%1] is waiting for thread [%2] to end.	-
liscal	Info	134	NMP%1 received signal. (%2)	Thread / Procedure [%2] received the termination request signal.	-
liscal	Info	135	NMP%1 exit.....OK. (%2)	Procedure [%2] ended normally.	-
liscal	Error	136	NMP%1 killing thread, but mount port is still opened.	The mounted mirror disk resource exists at unloading the mirror driver.	Check the mirror disk resource status.
liscal	Error	137	NMP%1 killing thread, but %2 I/O request still exist.	The mirror partition device is busy. The thread of the mirror driver is going to stop, but the I/O request to the mirror partition has not been still completed.	Check the mirror disk resources is not accessed.
liscal	Info	140	NMP%1 liscal will shutdown, N/W port closed.	An attempt will be made to perform shutdown with the mirror partition mounted. Mirror data transmission is stopped. Any data that is not transmitted is recorded as the mirror difference to perform mirror break.	Use clpstdn or clpdown to shut down the server. Check whether shutdown and reboot were used erroneously.
liscal	Warning	141	NMP%1 device does not exist. (%2)	NMP[%1] does not exist.	Check the cluster configuration information. Check if there is wrong setting with initial construction steps of the mirror disk or the hybrid disk. No problem in case of the following.
liscal	Info	141	- This message can be recorded on udev environment when liscal is initializing NMPx.	On the environment which udev runs, this message is output when the NMP[%1] is accessed before the mirror driver completes the initialization of NMP[%1].	For the workaround, see "Error message in the load of the mirror driver in the udev environment" of
liscal	Info	141	- Ignore this and following messages 'Buffer I/O error on device NMPx' on udev environment.	In this case, this message and buffer I/O error of NMP[%1] are displayed, but there is no problem.	"Notes and Restrictions" in Getting Started Guide.
liscal	Warning	142	NMP%1 N/W is not initialized yet. (%2)	The initialization of the driver has not completed yet.	A problem may have occurred with the mirror driver. Restart the system.
liscal	Warning	143	NMP%1 cache_table is not initialized. (%2)	The initialization of the driver has not completed yet.	Same as above.

Module Type	Event type	Event ID	Message	Description	Solution
liscal	Warning	144	NMP%1 I/O port has been closed, mount(%2), io(%3).	The mirror partition has not been mounted. But it was going to be accessed.	Check the mirror disk resource status.
					Check if there is any applications trying to access the mirror partition device directly.
					If output is made at deactivation, it takes time to write memory cache into a disk during unmount processing. This may cause a timeout. While referencing "Cache swell by a massive I/O" below, increase the unmount timeout value sufficiently.
					If the user specified an additional mount point to be created in a different location for the mirror partition device or mirror mount point, check if that mount point is configured to be unmounted before deactivation. See "When multiple mounts are specified for a resource like a mirror disk resource" below.
					For others, the following may be applicable.
liscal	Info	144	- This message can be recorded by fsck command when NMPx becomes active.	This message can be output in case that the mirror partition is accessed by fsck command before being mounted.	See the following notes and restrictions in the <i>Getting Started Guide</i> .
liscal	Info	144	- This message can be recorded on hotplug service starting when NMPx is not active.	And also, this message can be output when the hotplug service searches devices.	<ul style="list-style-type: none"> <li>• Buffer I/O error log for the mirror partition device</li> <li>• Messages written to syslog when multiple mirror disk resources or hybrid disk resources are used"</li> </ul>
liscal	Info	144	- Ignore this and following messages 'Buffer I/O error on device NMPx' on such environment.	This message and buffer I/O error of NMP[%1] are displayed in this case, but there is no problem.	<ul style="list-style-type: none"> <li>• Cache swell by a massive I/O</li> <li>• When multiple mounts are specified for a resource like a mirror disk resource</li> </ul>
liscal	Error	145	Failed to allocate %2 NMP%1 failed to allocate %2	Allocation of memory failed.	Execute the after-mentioned <b>↑coping process 1</b> (coping process to lack of resource).
liscal	Info	146	Failed to allocate %2, retrying. NMP%1 failed to allocate %2, retrying.	Allocation of memory failed. Memory allocation is retried.	Execute the after-mentioned <b>↑coping process 1</b> (coping process to lack of resource).



Module Type	Event type	Event ID	Message	Description	Solution
liscal	Warning	147	Failed to allocate %2, other area used instead.	Allocation of memory failed. The reserved area is used.	Execute the after-mentioned <b>†coping process 1</b> (coping process to lack of resource).
liscal	Info	148	NMP%1 holder %2. (%3)	The exclusive access count before or after (timing of [%3]) mount/unmount of NMP[%1] is [%2]. Normally, [%2] is 0 before mount or after unmount; [%2] is 1 after mount or before unmount. If the count is other than 0 even after unmount, it is possible that something is holding NMP[%1] or continues to hold it such that unmount cannot be completed.	If the count does not become 0 even after unmount and a file system error occurs, the unmount timeout setting may be insufficiently long. Refer to "Notes on stopping mirror disk resources or hybrid disk resources" and "Cache swell by a massive I/O" in "Notes and Restrictions" in the <i>Getting Started Guide</i> . If the count is other than 0 before mount, the fsck timeout setting may be insufficient. Refer to "fsck execution" in "Notes and Restrictions" in the <i>Getting Started Guide</i> .
liscal	Info	150	NMP%1 mirror break, writing mirror_break_time to Cluster Partition.	Mirror break occurred. Either there is a problem with mirror disk connection, or I/O to the disk failed in the remote server.	Check the mirror disk connection status. Check if the mirror disk connection or OS is highly-loaded.
liscal	Info	151	NMP%1 ACK1 timeout.	Timeout occurred while receiving the response to the sent mirror synchronization data (ACK1).	Same as above.
liscal	Info	152	NMP%1 mirror break has occurred during recovery, recovery failed.	Mirror break occurred while recovering the mirror. Mirror recovery will stop abnormally.	Same as above.
liscal	Info	154	NMP%1 N/W port opened.	The mirror synchronization data connection port opened because the connection became possible.	-
liscal	Info	155	NMP%1 N/W port closed.	The connection port closed because the connection became impossible.	-
liscal	Info	156	NMP%1 failed to %2, because N/W port has been closed.	Sending and receiving of data[%2] failed because the connection port had been closed.	Check the mirror disk connection status. Check if the mirror disk connection or OS is highly-loaded.
liscal	Info	157	NMP%1 failed to recover, because N/W port of remote server has been closed.	Mirror recovery failed because the connection port of the remote server had been closed.	Same as above.

Module Type	Event type	Event ID	Message	Description	Solution
liscal	Warning	158	NMP%1 received sync data, but mount port has been opened, sync failed.	The synchronization data from the remote server was received. But the mirror partition has been mounted on the local server. Then the received data was discarded.	Check if the mirror partition is deactive and is mounted.
liscal	Info	159	NMP%1 received request to stop sending data from remote server.	Synchronization data was sent to the remote server. However, the transmitted synchronization data was discarded because the remote server had mounted the mirror partition or transmission was disabled.	Same as above.
liscal	Error	160	NMP%1 disk I/O error%2	The I/O error to the disk occurred now or in the past. The system will reboot.	The physical defect may have occurred with mirror disk in case of being output while in operation. See Chapter 10, "The system maintenance information" in the Reference Guide, exchange the mirror disks and run mirror recovery. Check the cluster partition settings in cluster configuration information in case of being output while constructing the cluster.
liscal	Error	160	- Confirm that the new disk is cleared, if it has been replaced already.	See Chapter 10, "The system maintenance information" in the Reference Guide and clear the cluster partition in case that this message is output at startup even after exchanging the mirror disks.	
liscal	Error	160	- Replace the old error disk with a new cleared disk, if it has not been replaced yet.	SeeChapter 10, "The system maintenance information" in the Reference Guide and exchange the mirror disks in case of not having exchanged the mirror disks.	
liscal	Error	161	NMP%1 failed to %2 %3 %4 Cluster Partition.	The I/O[%2] (read/write / read / write / clear / flush) to the area in the Cluster Partition failed.	Execute the after-mentioned <b>†coping process 1</b> (coping process to lack of resource) when the lack of resource is possible. The physical defect may have occurred with mirror disk in case of being output while in operation. See Chapter 10, "The system maintenance information" in the Reference Guide, exchange the mirror disks and run mirror recovery. Check the cluster partition settings in cluster configuration information in case of being output while constructing the cluster.

Module Type	Event type	Event ID	Message	Description	Solution
liscal	Warning	162	NMP%1 failed to clear the bitmap. (%2)	In the processing [%4], the difference bitmap processing [%2] (set/clear) for the [%3] area failed.	Shut down the cluster and restart it.
liscal	Info	163	NMP%1 %2 is null. (%3)	The initialization of the driver has not completed.	A problem may have occurred with the mirror driver. Restart the system.
liscal	Warning	164	NMP%1 sector %2 not found. (%3)	The processing information to the corresponding sector[%2] was not found in the queue in the driver.	-
liscal	Warning	165	NMP%1 requested sector is out of NMP area. (%2)	The I/O request to the area exceeding the size of the mirror partition was received at procedure[%2]. This request was discarded.	-
liscal	Info	166	NMP%1 %2 is null. (%3)	An attempt was made to set a difference bitmap after it had already been set as having a difference.	-
liscal	Info	167	NMP%1 %2 is null. (%3)	An attempt was made to send ACK2 after it had already been sent.	-
liscal	Error	168	NMP%1 failed to %2 bitmap. Invalid %3	Processing [%2] on the differential bitmap for the [%3] area failed.	A problem may have occurred with the mirror driver. Check if the sizes of the single sectors of the mirror disks on the two servers differ.
liscal	Warning	170	ioctl() got %1 inode with NULL, exit.	Invalid ioctl() call was detected.	The OS may have become unstable. Restart the system.
liscal	Error	171	NMP%1 requested I/O with wrong command(%2) from FS.	Invalid I/O request was issued to the mirror partition from the file system or others. This request to the NMP device is incorrect.	Same as above.
liscal	Warning	172	request_id(%2) is too big. (%3) NMP%1 request_id(%2) is too big. (%3)	Invalid procedure number was detected at procedure[%3]. This request was discarded.	-
liscal	Warning	173	NMP%1 failed to send, but its ID was not found in request_queue. (%2)	Sending of the mirror synchronization data failed. An attempt to delete the processing information failed, because the corresponding procedure number was not found in the queue in the driver.	A problem may have occurred with the mirror driver. Restart the system.
liscal	Info	174	NMP%1 request_id(%2) deleted. (%3)	The processing information of procedure number[%2] was deleted normally from the queue in the driver due to the mirror synchronization data send failure.	-

Module Type	Event type	Event ID	Message	Description	Solution
liscal	Error	175	request_id(%2) ACK1 timeout, but its NMP%1 not found. (%3)	ACK1 (response to the sent mirror data) of procedure number[%2] had not been received in time. But the corresponding procedure number[%2] was not found in the queue in the driver.	A problem may have occurred with the mirror driver. Restart the system.
liscal	Info	176	NMP%1 received ACK1, but its ID was not found in request_queue.	ACK1 (response to the mirror synchronization data) was received. But the corresponding procedure number[%2] was not found in the queue in the driver. This message is output if ACK1 is received after it has not been received in time.	When Event ID:151 occurs before this event, this event may mean a server received ACK1 of Event ID:151 by high-load on partner or network. In this case, change Ack timeout too long. <b>(process 4)</b>
liscal	Info	177	NMP%1 received ACK2, but its ID was not found in wait_ack2_queue.	ACK2 (response to mirror synchronization completion notification ACK1) was received. But the corresponding procedure number[%2] was not found in the queue in the driver. This message is output if ACK2 is received after it has not been received in time.	-
liscal	Warning	178	request_id(%2) of ACK is not found in trans_table. (%3) NMP%1 request_id(%2) of ACK is not found in trans_table. (%3)	ACK (response to the sent recovery data) of procedure number[%2] was received. But the corresponding procedure number[%2] was not found in the queue in the driver. This message is output if ACK is received after it has not been received in time.	-
liscal	Info	179	NMP%1 received request to stop sending data, but its ID was not found in request_queue.	The request to close communication of the mirror synchronization data was received, instead of ACK1, from the remote server. But the corresponding procedure number[%2] was not found in the queue in the driver. Waiting for ACK1 reception may have already timed out.	-

Module Type	Event type	Event ID	Message	Description	Solution
liscal	Warning	180	%2 (%3) is invalid. The default setting (%4) will be used instead.	The parameter[%2] (value:[%3]) is invalid. The default value[%4] is used instead.	The setting file may have been mistakenly edited directly. Check the setting values by EXPRESSCLUSTER Builder. For the details of the parameters, see the after-mentioned <b>†coping process 2.</b>
			NMP%1 %2 (%3) is invalid. The default setting (%4) will be used instead.		
liscal	Info	181	NMP%1 %2 (%3) is invalid. The maximum number (%4) will be used instead.	The parameter[%2] (value:[%3]) is invalid. The maximum value[%4] is used instead.	In case that the timeout magnification adjustment (clptoratio command) is used, the value may exceed the maximum value. In this case, the maximum value is used. For the details of the parameters, see the after-mentioned <b>†coping process 2.</b>
liscal	Error	182	%2 (%3) is invalid. (%6) NMP%1 %2 (%3) is invalid. (%6) %2 (%3) or %4 (%5) is invalid. (%6) NMP%1 %2 (%3) or %4 (%5) is invalid. (%6)	The parameter[%2] (value:[%3]) or the parameter[%4] (value:[%5]) is invalid.	The setting file may have been mistakenly edited directly. Check the setting values by EXPRESSCLUSTER Builder.
liscal	Info	183	NMP%1 %2 is %3. Heartbeat of mirror disk connection will be ignored.	The parameter[%2] (value:[%3]) is specified. The mirror disk connection will not be used.	-
liscal	Info	184	The same %1 Partition is specified. Specify different partitions. (NMP%2, NMP%3)	The [%1] (Cluster/Data) partition specification is invalid. The same partition is specified for multiple (NMP[%2] and NNP[%3]) resources.	For the Linux version, separate cluster partitions and data partitions must be assigned to each resource. Correct the partition specification. If the partition configuration presents problems, also review the partition configuration.
liscal	Info	190	NMP%1 sync switch flag is set to ON. %2	The data synchronization is enabled.	-
liscal	Info	191	NMP%1 sync switch flag is set to OFF. %2	The data synchronization is disabled.	-
liscal	Info	192	NMP%1 open I/O port OK.	The I/O to the Data Partition started.	-
liscal	Info	193	NMP%1 close I/O port OK.	The I/O to the Data Partition stopped.	-
liscal	Info	194	NMP%1 open mount port OK.	The access to the mirror partition becomes possible.	-
liscal	Info	195	NMP%1 close mount port OK.	The access to the mirror partition becomes impossible.	-

Module Type	Event type	Event ID	Message	Description	Solution
liscal	Info	196	NMP%1 open N/W port OK.	The mirror synchronization data connection port is opened.	-
liscal	Info	197	NMP%1 close N/W port OK.	The mirror synchronization data connection port is closed.	-
liscal	Warning	200	NMP%1 bmp_size_in_sec (%2) is invalid.	The size of the area for the difference information is invalid. The Cluster Partition may be set incorrectly.	Check the settings of the cluster partition in the cluster configuration data.
liscal	Warning	201	NMP%1 failed to calculate bitmap offset (%2).	Calculation of the area of the difference information failed.	The OS may have become unstable. Restart the system.
liscal	Error	202	NMP%1 sector size of Data Partition (%2) is invalid.	The sector size of the Data Partition (%2) is too big.	Check if there is any incorrect setting with the mirror disk or the hybrid disk initial construction step.
liscal	Warning	203	NMP%1 failed to get total_bitmap_in_bits (%2). (%3)	Getting the mirror difference information failed at procedure[%3].	Same as above.
liscal	Warning	204	NMP%1 no trans_table available, recovery failed.	The mirror recovery failed. The mirror recovery could not utilize the management area of recovery because the number of NMPs recovering mirror has exceeded the upper limit.	Check the number of NMPs in the cluster configuration data. A problem may have occurred with the mirror driver. Restart the system and execute the mirror recovery again.
liscal	Warning	205	NMP%1 failed to lock disk I/O, recovery failed.	The mirror recovery failed. The mirror recovery could not exclude the other disk I/O.	A problem may have occurred with the mirror driver. Restart the system and then execute the mirror recovery again.
liscal	Warning	206	NMP%1 current NMP has been already locked.	Excluding the other disk I/O has been already executed. (A number of mirror recovery processes tried to operate the same data block.)	A problem may have occurred with the mirror driver. Restart the system and execute the mirror recovery again.
liscal	Warning	207	NMP%1 current NMP has not been locked.	The exclusion with the other disk I/O has already been released.	Same as above.
liscal	Warning	208	NMP%1 waited for sync data (sector=%2) written to disk completely, but timeout.	The disk I/O to sector[%2] did not finish in time before reading the mirror recovery data. The mirror recovery is going to be executed.	-
liscal	Info	209	NMP%1 waiting for recovery data to be %2. (%3/%4)	A shutdown request arrived while mirror recovery data is [%2] (read or written). [%3] of [%4] was being processed. The system waits for the remaining I/O to be completed.	-

Module Type	Event type	Event ID	Message	Description	Solution
liscal	Warning	210	NMP%1 failed to connect to remote server (err=%2).	Connecting to the remote server failed because of the reason[%2].	Check the settings of the mirror disk connection in the cluster configuration data.
					Check the mirror disk connection status. Check if the mirror disk connection or OS is highly-loaded.
					The connection time-out value may be too small. Increase the number. (see the after-mentioned <b>tcoping process</b> .)
liscall	Info	211	NMP%1 failed to send %2, retrying again.	Sending [%2] failed. It will be sent again.	Check the mirror disk connection status. Check that neither mirror disk connection nor the operating system is loaded heavily. This will not cause a problem on the operation immediately, however, may be a cause of mirror break in the long run.
					The send time-out value may be too small. Increase the number. (see the after-mentioned <b>tcoping process</b> .)
liscal	Warning	212	NMP%1 failed to send %2.	Sending [%2] failed.	Check the mirror disk connection status. Check that neither mirror disk connection nor the operating system is loaded heavily.
					Check if the mirror agent on the remote server is running.
liscal	Error	213	NMP%1 failed to read recovery data.	Reading the mirror recovery data failed.	In case that the lack of resource is possible, execute the after-mentioned <b>tcoping process 1</b> (coping process to lack of resource).
					The physical defect may have occurred with mirror disk in case of being output while in operation. See Chapter 10, "The system maintenance information" in the Reference Guide, exchange the mirror disks and run mirror recovery.
liscal	Warning	214	NMP%1 failed to write recovery data.	Writing the mirror recovery data failed at the local server.	Same as above.
			NMP%1 failed to write recovery data at remote server.	Writing the mirror recovery data failed at the remote server.	

Module Type	Event type	Event ID	Message	Description	Solution
liscal	Info	215	NMP%1 failed to recover because of %2.	The disconnection of the mirror disk connection was detected before receiving the response to the sent mirror recovery data. Or the mirror recovery was canceled. The mirror recovery will stop.	Check the mirror disk connection status. Check that neither mirror disk connection nor the operating system is loaded heavily.
liscal	Info	216	NMP%1 ACK timeout, %2, retrying again.	The response to the sent data (%2) of the mirror recovery could not be received in time. The data will be sent again.	Check the mirror disk connection status. Check that neither mirror disk connection nor the operating system is loaded heavily. Increase the time-out values and/or decrease the Recovery Data Size. (See the after-mentioned <b>troubleshooting process 4.</b> )
liscal	Warning	217	NMP%1 ACK timeout, %2, recovery failed.	The response to the sent data (%2) of the mirror recovery could not be received in time again. The mirror recovery failed.	Check the mirror disk connection status. Check that neither mirror disk connection nor the operating system is loaded heavily. Increase the time-out values and/or decrease the Recovery Data Size. (See the after-mentioned <b>troubleshooting process 4.</b> )
liscal	Warning	218	NMP%1 async send queue is full. Mirror break.	The queue for the data to be sent has become full. The mirror break status is set.	Check the mirror disk connection status. Check that neither mirror disk connection nor the operating system is loaded heavily.
liscal	Info	219	NMP%1 can not send async data, because N/W port has been closed.	Data in the data transmission queue cannot be transmitted because the mirror disk connect is disconnected.	Check the connection status of the mirror disk connect. Check whether the mirror disk connect, disk I/O, or OS is highly loaded.
liscal	Warning	220	NMP%1 failed to create %2 socket (%3).	Creation of the connection for [%2] failed because of the reason[%3].	Check the settings of the mirror disk connection in the cluster configuration data.
			NMP%1 failed to create %2 socket.		Check the mirror disk connection status. Check that neither mirror disk connection nor the operating system is loaded heavily. Check if other applications or the others are using the resources (port, etc.) for the mirror connection. (See the after-mentioned <b>troubleshooting process 3</b> )



Module Type	Event type	Event ID	Message	Description	Solution
					In case that the lack of resource is possible, execute the after-mentioned <b>†coping process 1</b> (coping process to lack of resource).
liscal	Warning	221	NMP%1 failed to bind %2 socket (%3).	Same as above.	Same as above.
liscal	Warning	222	NMP%1 failed to listen %2 socket (%3).	Same as above.	Same as above.
liscal	Warning	223	NMP%1 failed to accept %2 socket (%3).	Same as above.	Same as above.
liscal	Warning	224	NMP%1 failed to receive %2 (err=%3).	Receiving data[%2] (of the [%4] area) because of the reason[%3].	Check the mirror disk connection status. Check that neither mirror disk connection nor the operating system is loaded heavily.
			NMP%1 failed to receive %2 (err=%3), %4.		The receive time-out value may be too small. Increase the number. See the after-mentioned <b>†coping process</b> .
liscal	Warning	225	NMP%1 received wrong head part. (magic=%2 cmd=%3) (%4)	Invalid data was received. (magic=[%2], cmd=[%3])	Applications other than EXPRESSCLUSTER may be using the mirror disk connect. Keep applications other than EXPRESSCLUSTER from accessing to the mirror connect. For the details of the ports used by EXPRESSCLUSTER, See Chapter 10, "Communication ports", "Cluster driver device information" of "The system maintenance information" in the Reference Guide.
					A defect may have occurred with the mirror disk connect. Check the mirror disk connection status.
liscal	Warning	226	NMP%1 received wrong command (cmd=%2).	Invalid mirror data was received. (cmd=[%2])	Same as above.
			NMP%1 received wrong command (cmd=%2) instead of %3.	Invalid data was received at the port for the [%3] (HB / ACK2). (cmd=[%2])	
liscal	Warning	227	NMP%1 failed to uncompress %2.	Uncompression of the data[%2] failed.	Execute the after-mentioned <b>†coping process 1</b> (coping process to lack of resource).

Module Type	Event type	Event ID	Message	Description	Solution
liscal	Warning	228	NMP%1 failed to execute received command. (cmd=%2, err=%3)	The request of [%2] had been received and processed, but [%3] error occurred.	For the details of the error, see the log output before this log.
liscal	Warning	229	NMP%1 failed to receive data, because recv_sock is NULL.	Receiving the mirror data failed.	A problem may have occurred with the mirror driver. Restart the system.
liscal	Info	230	NMP%1 recv_sock is NULL, can not delete keepalive timer.	Same as above.	Same as above.
liscal	Warning	231	NMP%1 accepted receive data, but this server is not current server of hybrid disk.	The local server received the mirror data even though the other server is running as the Current server of hybrid disk configuration. The received data was ignored. The received data will be sent again from the source server to the Current server.	-
liscal	Info	232	NMP%1 disconnected %2 N/W. (%3)	The connection to receive [%2] (DATA / HB / ACK2) was disconnected at procedure[%3].	-
liscal	Info	233	NMP%1 failed to receive recovery data at remote server, retrying again.	The remote server could not receive the recovery data. The local server is going to send it again.	Check the mirror disk connection status. Check that neither mirror disk connection nor the operating system is loaded heavily.
liscal	Warning	234	NMP%1 failed to receive recovery data at remote server, recovery failed.	The remote server could not receive the recovery data again. Recovery was failed.	Same as above.
liscal	Warning	235	NMP%1 gave up ACK before ACK timeout.	Waiting for the response to the sent mirror recovery data (ACK) was suspended before ACK receive timeout occurs due to the disconnection of mirror disk connection.	Same as above.
liscal	Warning	236	NMP%1 gave up ACK1 before ACK1 timeout.	Waiting for the response to the sent mirror recovery data (ACK1) was suspended before ACK receive timeout occurs due to the disconnection of mirror disk connection.	Same as above.
liscal	Warning	240	NMP%1 status of current using N/W is ERROR. (%2)	The mirror disk connection is abnormal. Then the data could not be sent.	Check the mirror disk connection status. Check that neither mirror disk connection nor the operating system is loaded heavily.
liscal	Warning	241	NMP%1 can not find a N/W to use. (%2)	There is no mirror disk connection available for [%2] (DATA / HB / ACK2).	Check the cluster configuration information.

Module Type	Event type	Event ID	Message	Description	Solution
					Check the mirror disk connection status. Check that neither mirror disk connection nor the operating system is loaded heavily.
liscal	Warning	242	NMP%1 all of the networks are ERROR.	All the mirror disk connections became abnormal.	Same as above.
liscal	Info	243	NMP%1 N/W is %2 %3 - %4 :%5(%6)	The status of the current mirror disk connection for [%6] (DATA / HB / ACK2) was changed to [%2] (ERROR / USING / FREE). IP addresses: [%3] and [%4] Port: [%5]	Check the mirror disk connection status in case that the status is ERROR. Check that neither mirror disk connection nor the operating system is loaded heavily.
			NMP%1 N/W is %2 %3 - %4		
liscal	Warning	250	Received ICMP. Length of received ICMP is less than 8.	ICMP packet was received. But its length was Invalid. It was Ignored.	
liscal	Info	251	Received ICMP. Type=(%1) Code=(%2)	ICMP packet of type [%1] and code [%2] was received. ("Destination unreachable" was received.)	
liscal	Info	252	Received ICMP. Type=(%1) Code=(%2). Ignored.	ICMP packet of type [%1] , code [%2] and ID [%3] was received. It was Ignored.	
			Received ICMP. Type=(%1) with same ID(%3). Ignored.		
liscal	Warning	260	NMP%1 failed to switch N/W to (priority:%2). (%3)	Switching the mirror disk connection was requested. But it failed because of the reason [%3].	Check the cluster configuration information.
					Check the mirror disk connection status. Check that neither mirror disk connection nor the operating system is loaded heavily.
liscal	Info	261	NMP%1 already switched N/W to (priority:%2).	Switching the mirror disk connection was requested. But it has already been switched to [%2].	
liscal	Info	262	NMP%1 uses N/W (priority:%2).	The mirror disk connection of the priority [%2] will be used.	
liscal	Info	263	NMP%1 switched N/W from (priority:%2) to (priority:%3).	Switching the mirror disk connection was requested. Then the mirror disk connection of the priority [%2] will be used instead of the priority [%3].	
liscal	Info	270	NMP%1 this FS type (%2) is not supported for high speed full copy.	In the current version this file system cannot be processed with the high speed full-copy. Full-copy will be performed without an analysis of the file system instead.	

Module Type	Event type	Event ID	Message	Description	Solution
liscal	Info	271	NMP%1 FS type is %2.	The target file systems for mirror recovery are [%2] (EXT2 / EXT3 / EXT4).	-
liscal	Warning	272	NMP%1 could not read %2 of FS.	Reading the [%2] area of the file system failed. Full-copy will be performed without an analysis of the file system instead.	-
liscal	Warning	273	NMP%1 failed to set the bitmap dependent on FS.	Creation of the difference information corresponding to the area used by the file system failed. Full-copy will be performed without an analysis of the file system instead.	-
liscal	Info	280	NMP%1 requested to change compress flag. (Sync data : %2) (Recovery data : %3)	Compression of the mirror transfer data was changed to [%2] (ON / OFF) and [%3] (ON / OFF).	-
liscal	Info	281	NMP%1 flag of compress (Sync data:%2) (Recovery data:%3)	The compression function for mirror transfer data is set to [%2](ON/OFF) and [%3](ON/OFF).	-
liscal	Info	290	NMP%1 logging statistics information started. (PID=%2)	Logging of mirror statistic information has started.	-
liscal	Info	291	NMP%1 logging statistics information stopped. (PID=%2)	Logging of mirror statistic information has stopped.	-
liscal	Info	292	NMP%1 logging statistics information cleared.	The mirror statistic information counter has been cleared.	-
liscal	Warning	293	NMP%1 statistics information not found. (PID=%2)	Internal error Processing has not yet been started, or an attempt was made to access a mirror statistic information record that had already ended.	If mirror statistic information was already acquired by a command, reexecute that command.
liscal	Info	294	Perf%1	Output result [%1] of mirror statistic information	-
liscal	Info	300	NMP%1 QoS %2 KB/sec.	The band limitation was set to [%2].	-

**†coping process 1** coping process to lack of resource

The physical memory may be running short.  
 Add more physical memory or stop unnecessary applications.

The upper limit of I/O request queue number ensured by the mirror driver may be too big.  
 In case that a massive amount of I/O over transaction performance are requested to the mirror disk, the kernel memory is used because the I/O requests are queued in the mirror driver.  
 Decrease the maximum number of the request queue in **Mirror Driver** tab of **Cluster Properties** by seeing Chapter 2, "Function of the Builder" in the *Reference Guide*.

The file system may ensure a massive amount of the cache.  
 In case that a massive amount of I/O over transaction performance are requested, the memory zone for kernel space may be used for the file system cache in addition to the cache and the memory zone for user space.  
 In that case, as a workaround, keep the memory zone for kernel space used by the driver from being utilized as the cache by setting `/proc/sys/vm/lower_zone_protection`.  
 See "Cache swell by a massive I/O" in Chapter 5, "Notes and Restrictions" in the *Getting Started Guide*.

### tcping process 2 Parameters

Parameter names output in log	Setting Item Names in EXPRESSCLUSTER Builder	Positions of Setting Items in EXPRESSCLUSTER Builder
Bitmap refresh interval	Bitmap Refresh Interval (bpchkinterval)	Cluster Properties - Mirror Driver tab
max_cachenum	(maxcache)	(In the configuration file)
send_queue_size	The number of queues (sendqueuesize)	Mirror Disk Resource Tuning Properties - Mirror tab
band_limit_mode	Rate limitation of Mirror Connect (mode)	
band_limit	Rate limitation of Mirror Connect (bandlimit)	
ack_timeout	Ack Timeout (acktimeout)	Mirror Disk Resource Tuning Properties - Mirror Driver tab
connect_timeout	Connection Timeout (connecttimeout)	
send_timeout	Send Timeout (sendtimeout)	
receive_normal_timeout	Receive Timeout (recvnormaltimeout)	
hb_interval	Heartbeat Interval (hbinterval)	
hb_rcv_timeout	ICMP Receive Timeout (pingtimeout)	
hb_rcv_retry	ICMP Retry Count (pingretry)	
keepalive_time	(keepalive/timeout)	(In the configuration file)
keepalive_probe	(keepalive/prob)	
keepalive_interval	(keepalive/interval)	
lastupdate_delay	(lupdate delay)	

For the details of each parameter, see the following chapters in the *Reference Guide*.

- Chapter 2, "Cluster properties" in "Function of the Builder"
- Chapter 4, "Understanding mirror disk resources" and "Understanding hybrid disk resources" in "Group resource details"
- Chapter 3, "Adjusting time-out temporarily (clptoratio command)" in "EXPRESSCLUSTER command reference"

**tcping process 3** For the details of the ports used by the mirror driver, see the following.

- Chapter 5, "Connection port number" of "Notes and Restrictions" in the *Getting Started Guide*
- Chapter 5, "Changing the range of automatic allocation for the communication port numbers" of "Notes and Restrictions" in the *Getting Started Guide*
- Chapter 4, "Understanding mirror parameters" of "Group resource details" in the *Reference Guide*
- Chapter 4, "Mirror driver tab" of "Group resource details" in the *Reference Guide*

- Chapter 10, “Communication ports” of “The system maintenance information” in the *Reference Guide*
- Chapter 1, “Settings after configuration hardware” of “Determining a system configuration” in the *Installation and Configuration Guide*

**Handling process 4** Timeout parameters of mirror

Setting Item Names in EXPRESSCLUSTER Builder	Positions of Setting Items in EXPRESSCLUSTER Builder
Recovery Data Size	Cluster Properties - Mirror Agent tab
Ack Timeout	Mirror Disk Resource Tuning Properties - Mirror Driver tab
Connection Timeout	
Send Timeout	
Receive Timeout	

For the details of each parameter, see the following chapters in the *Reference Guide*.

- Chapter 2, “Cluster properties” in “Function of the Builder”
- Chapter 4, “Understanding mirror disk resources” and “Understanding hybrid disk resources” in “Group resource details”
- Chapter 3, “Adjusting time-out temporarily (clptoratio command)” in “EXPRESSCLUSTER command reference”

## Kernel mode LAN heartbeat driver

Module Type	Event type	Event ID	Message	Description	Solution
clpkhb	Info	101	Kernel Heartbeat was initialized successfully. (major=%1, minor=%2)	The clpkhb driver was successfully loaded.	
clpkhb	Info	102	Kernel Heartbeat was released successfully.	The clpkhb driver was successfully unloaded.	
clpkhb	Error	103	Can not register miscdev on minor=%1. (err=%2)	Loading the clpkhb driver failed.	
clpkhb	Error	104	Can not deregister miscdev on minor=%1. (err=%2)	Unloading the clpkhb driver failed.	
clpkhb	Info	105	Kernel Heartbeat was initialized by %1.	The clpkhb driver was successfully initialized by [%1] module.	
clpkhb	Info	106	Kernel Heartbeat was terminated by %1.	The clpkhb driver was successfully terminated by [%1] module.	
clpkhb	Error	107	Can not register Kernel Heartbeat proc file!	The clpkhb driver failed to create proc file.	
clpkhb	Error	108	Version error.	The inside version information of the clpkhb driver is invalid.	Reinstall EXPRESSCLUSTER.
clpkhb	Info	110	The send thread has been created. (PID=%1)	The send thread of the clpkhb driver was successfully created. Its process ID is [%1].	
			The recv thread has been created. (PID=%1)	The receive thread of the clpkhb driver was successfully created. Its process ID is [%1].	
clpkhb	Error	111	Failed to create send thread. (err=%1)	The clpkhb driver failed to create the send thread due to the error [%1].	
			Failed to create recv thread. (err=%1)	The clpkhb driver failed to create the receive thread due to the error [%1].	
clpkhb	Info	112	Killed the send thread successfully.	The send thread of clpkhb driver was successfully stopped.	
			Killed the recv thread successfully.	The receive thread of clpkhb driver was successfully stopped.	
clpkhb	Info	113	Killed the recv thread successfully.	The clpkhb driver is going to stop.	
clpkhb	Info	114	Killed the send thread successfully.	The clpkhb driver is going to stop.	
clpkhb	Info	115	Kernel Heartbeat has been stopped	The clpkhb driver successfully stopped.	
clpkhb	Error	120	Failed to create socket to send %1 packet. (err=%2)	Creating the socket for sending the [%1] (HB / DOWN / KA) packet failed due to the error [%2].	
			Failed to create socket to receive packet. (err=%2)	Creating the socket for receiving the packet failed due to the error [%2].	

Module Type	Event type	Event ID	Message	Description	Solution
clpkhb	Error	121	Failed to create sending %1 socket address. (err=%2)	Setting the socket for sending the [%1] (HB / DOWN / KA) packet failed.	The physical memory may be running out. Add physical memories, or terminate unnecessary applications.
clpkhb	Error	122	Failed to create %1 socket address. (err=%2)	Setting the socket for sending the [%1] (HB / DOWN / KA) packet failed.	The physical memory may be running out. Add physical memories, or terminate unnecessary applications.
clpkhb	Error	123	Failed to bind %1 socket. (err=%2)	Binding the socket for [%1] (HB / DOWN / KA) failed.	<p>Check the status of the operating system.</p> <p>The communication port for clpkhb may be used already by other applications or others. Check the usage status of the communication port.</p> <p>Check the cluster configuration information server property if the IP address set for the interconnect LAN I/F is correct.</p>
clpkhb	Error	125	Failed to send %1 data to %2. (err=%3)	Sending [%1] (HB / DOWN / KA) data to [%2] failed.	<p>Check the status of the network for the clpkhb communication.</p> <p>Check the status of the remote server.</p> <p>Check that the setting information is correct.</p>
clpkhb	Error	126	Failed to receive data. (err=%3)	Receiving data failed.	<p>The remote server may be down. Check if the server is active.</p> <p>If the server is not down, check the status of the network for clpkhb.</p>
clpkhb	Info	127	Received an invalid packet. magic is not correct!	An invalid packet was received. It is ignored.	Other applications may be sending the data to the port for clpkhb. Change the Heartbeat Port Number if other applications use it.
clpkhb	Error	128	Received an invalid packet. %1 is not correct!	An invalid packet was received. The invalid part of the packet is [%1] (Resource priority / Source ip address).	Same as above.
clpkhb	Info	129	Receiving operation was interrupted by ending signal!	The receive thread ends by termination signal.	-
clpkhb	Info	130	clpka: <server priority: %1> <reason: %2> <process name: %3> system reboot.	A reset message was received from another server. The priority [%1] server is going to be reset because of the reason [%2] in the process [%3].	Check the status of the server where the reboot occurred.



Module Type	Event type	Event ID	Message	Description	Solution
clpkhb	Info	131	clpka: <server priority: %1> <reason: %2> <process name: %3> system panic.	A panic message was received from another server. A panic of the priority [%1] server is going to be performed because of the reason [%2] in the process [%3].	Check the status of the server where the panic occurred.
clpkhb	Error	140	Reference an inaccessible memory area!	ioctl() failed to pass data to an application.	Check the status of the operating system.
clpkhb	Error	141	Failed to allocate memory!	Memory allocation failed.	The physical memory may be running out. Add physical memories, or terminate unnecessary applications.
clpkhb	Error	142	Invalid argument, %1!	The parameter passed to the clpkhb driver is not correct.	Check if the settings are correct.
clpkhb	Warning	143	Local node has nothing with current resource.	The heartbeat resource information passed to the clpkhb driver is not correct.	Same as above.

## Keepalive driver

Module Type	Event type	Event ID	Message	Description	Solution
clpka	Info	101	Kernel Keepalive was initialized successfully. (major=%1, minor=%2)	The clpka driver was successfully loaded.	-
clpka	Info	102	Kernel Keepalive was released successfully.	The clpka driver was successfully unloaded.	-
clpka	Error	103	Can not register miscdev on minor=%1. (err=%2)	Loading the clpka driver failed.	Check the distribution and kernel support the kernel mode LAN heartbeat.
clpka	Info	105	Kernel Keepalive was initialized by %1.	The clpka driver was successfully initialized.	-
clpka	Error	107	Can not register Kernel Keepalive proc file!	The clpka driver failed to create proc file.	The kernel may not be running normally because of lack of memory or other reasons. Add physical memories, or terminate unnecessary applications.
clpka	Error	108	Version error.	The version of the clpka driver is invalid.	Check if the installed clpka driver is legitimate.
clpka	Error	111	Failed to create notify thread. (err=%1)	The clpka driver failed to create the thread.	The kernel may not be running normally because of lack of memory or other reasons. Add physical memories, or terminate unnecessary applications.
clpka	Info	130	Reboot tried.	The clpka driver is going to restart the machine according to the action setting.	-
clpka	Info	132	Kernel do nothing.	The clpka driver is not going to do anything according to the action setting.	-

Module Type	Event type	Event ID	Message	Description	Solution
clpka	Error	140	Reference an inaccessible memory area!	Passing the version information of the clpka driver to the cluster main body failed.	Check if the installed clpka driver is legitimate.
clpka	Error	141	Failed to allocate memory!	The size of physical memory is not sufficient.	The physical memory is running out. Add physical memories, or terminate unnecessary applications.
clpka	Error	142	Invalid argument, %1!	Invalid information was passed from the cluster main body to the clpka driver.	Check if the installed clpka driver is legitimate.
clpka	Error	144	Process (PID=%1) is not set.	A process other than cluster main body tried operation to the clpka driver.	Check if there is any application trying to access to the clpka driver erroneously.

## Detailed information in activating and deactivating group resources

### Floating IP resources

Module type	Type	Return value	Message	Description	Solution
fip	Error	3	Command failed. (%1, ret=%2)	Failed in executing the command %1. The return value is %2.	Analyze the failure from the return value of the command.
fip	Error	11	Command failed. (%1(%2), errno=%3)	An error has occurred in executing the command.	Memory or OS resources may not be sufficient. Check them.
fip	Error	14	IP address did not exist.	Failed to get the IP address list.	Confirm that the OS can use the TCP/IP protocol.
fip	Error	15	IP address was already used.	The IP address is already used.	Check the IP address is not already used.
fip	Error	15	This ip address was already used. IP=%1	The specified IP address exists on the same network.	Check if the specified IP address is not used on the network.
fip	Error	17	Fip interface was not found.	Floating IP address interface was not found.	Check if the FIP address network is the same as the server's real IP address.
fip	Error	others	Internal error. (status=%1)	An error other than the errors mentioned above has occurred.	Memory or OS resources may not be sufficient. Check them.

## Virtual IP resource

Module type	Type	Return value	Message	Description	Solution
vip	Error	3	Command failed. (%1, ret=%2)	Failed in executing the command %1. The return value is %2.	Analyze the failure from the return value of the command.
vip	Error	11	Command failed. (%1(%2), errno=%3)	An error has occurred in executing the command.	Memory or OS resources may not be sufficient. Check them.
vip	Error	14	IP address did not exist.	Failed to acquire the list of IP addresses.	Check the OS is in the environment that supports the TCP/IP protocol.
vip	Error	15	IP address was already used.	The IP address is already used.	Check if the IP address is not already used.
vip	Error	15	This ip address was already used. IP=%1	The specified IP address exists on the same network.	Check if the specified IP address is not already used on the network.
vip	Error	17	Vip interface was not found.	The specified interface was not found.	Check if the specified interface exists on the server.
vip	Error	Others	Internal error. (status=%1)	Other internal error was occurred.	Memory or OS resources may not be sufficient. Check them.

## Disk resources

Module type	Type	Return value	Message	Description	Solution
disk	Error	1	Resource name was invalid. (%1)	The resource name is invalid.	Check the resource name is consistent with the information in the cluster configuration data.
disk	Error	1	Group name was invalid. (%1)	The group resource name is invalid.	Check the group name is consistent with the information in the cluster configuration data.
disk	Error	1	Resource was not in config. (%1)	The resource name does not exist in the cluster configuration data.	Check the resource name is consistent with the information in the cluster configuration data.
disk	Error	1	Group was not in config. (%1)	The group resource name does not exist in the cluster configuration data.	Check the group resource name is consistent with the information in the cluster configuration data.

Detailed information in activating and deactivating group resources

Module type	Type	Return value	Message	Description	Solution
disk	Error	1	Getting of config was failed.	Failed to obtain the cluster configuration data.	Check the cluster configuration data exists.
disk	Error	1	Mount point was already mounted. (%1)	The device has already been mounted.	Check if the specified device is unmounted.
disk	Error	1	Mount point was not mounted. (%1)	The mount point was not mounted.	An active resource may have been manually unmounted. Check its status.
disk	Error	1	Mount point was invalid. (%1)	The mount point is invalid.	Check the mount point exists.
disk	Error	1	Creating of mount point was failed. (%1)	Failed to create the mount point.	Memory or OS resources may not be sufficient. Check them.
disk	Error	1	Raw device was already bound. (%1)	The RAW device has already been bound by another device.	Check if the unique raw device is set in the cluster.
disk	Error	1	Max recover retry over. (%1, retry=%2)	The number of retries made for activating the device has exceeded the maximum retry count.	Check the cluster configuration data is correct.
disk	Error	1	Command path was invalid. (%1)	The execution path is invalid.	Check the command execution path.
disk	Error	1	Command timeout. (%1, timeout=%2)	Detected an internal timeout.	The OS may be heavily loaded. Check its status.
disk	Error	1	Command failed. (%1, ret=%2)	The command %1 failed. Its return value is %2.	Troubleshoot the problem by using the return value from the command.
disk	Error	1	Command failed. (%1(%2), errno=%3)	The device operation terminated abnormally.	Memory or OS resources may not be sufficient. Check them.
disk	Error	1	Internal error. (status=%1)	An error other than the errors mentioned above has occurred.	Memory or OS resources may not be sufficient. Check them.

## NAS resources

Module Type	Type	Return value	Message	Description	Solution
nas	Error	1	Resource name was invalid. (%1)	The resource name is invalid.	Check the resource name is consistent with the information in the cluster configuration data.
nas	Error	1	Group name was invalid. (%1)	The group resource name is invalid.	Check the group name is consistent with the information in the cluster configuration data.

Module Type	Type	Return value	Message	Description	Solution
nas	Error	1	Resource was not in config. (%1)	The resource name does not exist in the cluster configuration data.	Check the resource name is consistent with the information in the cluster configuration data.
nas	Error	1	Group was not in config. (%1)	The group resource name does not exist in the cluster configuration data.	Check the group resource name is consistent with the information in the cluster configuration data.
nas	Error	1	Getting of config was failed.	Failed to obtain the cluster configuration data.	Check the cluster configuration data exists.
nas	Error	1	Mount point was already mounted. (%1)	The resource on the NAS server has already been mounted.	Check if the specified resource in the NAS server is unmounted.
nas	Error	1	Mount point was not mounted. (%1)	The mount point was not mounted.	The active resource may have been manually unmounted. Check its status.
nas	Error	1	Mount point was invalid. (%1)	The mount point is invalid.	Check the mount point exists.
nas	Error	1	Creating of mount point was failed. (%1)	Failed to create the mount point.	Memory or OS resources may not be sufficient. Check them.
nas	Error	1	Max recover retry over. (%1, retry=%2)	The number of retries made for mounting resource on the NAS server has exceeded the maximum retry count.	Check that the cluster configuration data is correct.
nas	Error	1	Command path was invalid. (%1)	The execution path is invalid.	Check the command execution path.
nas	Error	1	Command timeout. (%1, timeout=%2)	Detected an internal timeout.	The OS may be heavily loaded. Check its status.
nas	Error	1	Command failed. (%1, ret=%2)	The command %1 failed. Its return value is %2.	Troubleshoot the problem by using the return value from the command.
nas	Error	1	Command failed. (%1(%2), errno=%3)	An error occurred while running the command.	Memory or OS resources may not be sufficient. Check them.
nas	Error	1	Internal error. (status=%1)	Other internal error has occurred.	Memory or OS resources may not be sufficient. Check them.

**EXEC resources**

Module Type	Type	Return value	Message	Description	Solution
exec	Error	1	Termination code %1 was returned.	An exit code other than 0 (zero) was returned as the result of a synchronous script or application.	There may be a problem in the content of the script. Check the script is correct.  The application may have abnormally terminated. Check how the application is working.
exec	Error	1	Command was not completed within %1 seconds.	A synchronous script or application did not successfully complete within the specified time.	There may be a problem in the content of the script. Check if the script is correct.  The application may be stalling. Check if the application is working properly.  You may be able to identify the cause from the logs in both cases. For details about logging settings, see "Parameter details" in Chapter 3, "Functions of the Builder" of this guide.
exec	Error	1	Command was aborted.	A synchronous script or application terminated abnormally.	The application may have abnormally terminated. Check how the application is working.  Memory or OS resources may not be sufficient. Check them.
exec	Error	1	Command was not found. (error=%1)	The application does not exist.	The path to the application may be invalid. Check it in the cluster configuration data
exec	Error	1	Command string was invalid.	The application path is invalid.	Check the application path in the cluster configuration data.
exec	Error	1	Log string was invalid.	The log output path is invalid.	Check the log output path in the cluster configuration data.
exec	Error	1	Internal error. (status=%1)	An error other than the errors mentioned above has occurred.	Memory or OS resources may not be sufficient. Check them.

## Mirror disk resources

Module Type	Type	Return value	Message	Description	Solution
md	Error	1	Need to start mirror agent at first.	The Mirror Agent is not active.	Check if the Mirror Agent is activated.
md	Error	2	Options or parameters are invalid.	Parameters are invalid.	Check the cluster configuration data is correct.
md	Error	4	Getting of config was failed.	Failed to obtain the cluster configuration data.	Check the cluster configuration data exists.
md	Error	10	NMP size of local server is bigger, can not active	The server cannot activate the mirror disk resource because the size of NMP of the local server is larger than that of the remote server.	Execute the forcible mirror recovery using the remote server as the one to be mirrored.
md	Error	30	Internal error[status=%1]	An error other than the errors mentioned above has occurred.	Memory or OS resources may not be sufficient. Check them. If the status is 2359554, the previous start or execution of a system command such as fsck may have failed. In this case, check the result of the failed command.
md	Error	77	Mirror disk was not in config.(%1)	Configuration data of the mirror disk resource is invalid.	Check the cluster configuration data is correct.
md	Error	79	Failed to get cluster partition information.	Failed to obtain the cluster partition data.	Check the partition is allocated and the operating system can recognize the disk.
md	Error	80	Mount point was already mounted.(%1)	The mount point has already been mounted.	Check if the mount point of the mirror disk resource has been mounted manually.
md	Error	81	The local server has not the latest data.(%1)	The local server does not have the latest data.	Perform the mirror recovery.
md	Error	82	Failed to set cluster partition information.	Failed to access the cluster partition.	Check if the partition is allocated, and the operating system can recognize the disk.



Module Type	Type	Return value	Message	Description	Solution
md	Error	83	Command timeout(%1, timeout=%2)	The system command timed out.	It took longer than expected to run the system command.  Tune the mount time-out, unmount time-out, and fsck time-out values. For details, see Chapter 3, "Functions of the Builder" of this guide.
md	Error	84	Mount point was not mounted. (%1)	The mirror disk resource is not mounted.	Check if it has manually been unmounted. Check the memory. EXPRESSCLUSTER controls mounting and unmounting. Do not mount or unmount it manually.
md	Error	87	Creating of mount point was failed. (%1)	Failed to create the mount point.	Check mount point has been specified in the cluster configuration data.  Check if the mount point exists.
md	Error	89	Command failed. (%1)	Failed to run the system command.	Check if mount, unmount and fsck commands exist.

## Hybrid disk resources

Module Type	Type	Return value	Message	Description	Solution
hd	Error	1	Need to start mirror agent at first.	The Mirror Agent is not active.	Check if the Mirror Agent is activated.
hd	Error	2	Options or parameters are invalid.	Parameters are invalid.	Check the cluster configuration data is correct.
hd	Error	4	Getting of config was failed.	Failed to obtain the cluster configuration data.	Check the cluster configuration data exists.
hd	Error	10	NMP size of local server is bigger, can not active	The server cannot activate the mirror disk resource because the size of NMP of the local server is larger than that of the remote server.	Execute the forcible mirror recovery using the remote server as the one to be mirrored.
hd	Error	12	The local server is not current server.	Resources cannot be operated because the local server is not current server.	Operate the resources after acquiring the condition where current priority can be acquired in the local server or acquiring the current priority.
hd	Error	30	Internal error[status=%1]	An error other than the errors mentioned above	Memory or OS resources may not be

Module Type	Type	Return value	Message	Description	Solution
				has occurred.	sufficient. Check them.
hd	Error	77	Hybrid disk was not in config.(%1)	Configuration data of the hybrid disk resource is invalid.	Check the cluster configuration data is correct.
hd	Error	79	Failed to get cluster partition information.	Failed to obtain the cluster partition data.	Check the partition is allocated and the operating system can recognize the disk.
hd	Error	80	Mount point was already mounted.(%1)	The mount point has already been mounted.	Check if the mount point of the mirror disk resource has been mounted manually.
hd	Error	81	The local server has not the latest data.(%1)	The local server does not have the latest data.	Perform the mirror recovery.
hd	Error	82	Failed to set cluster partition information.	Failed to access the cluster partition.	Check if the partition is allocated, and the operating system can recognize the disk.
hd	Error	83	Command timeout(%1, timeout=%2)	The system command timed out.	It took longer than expected to run the system command.  Tune the mount time-out, unmount time-out, and fsck time-out values. For details, see Chapter 3, "Functions of the Builder" of this guide.
hd	Error	84	Mount point was not mounted. (%1)	The mirror disk resource is not mounted.	Check if it has manually been unmounted. Check the memory. EXPRESSCLUSTER controls mounting and unmounting. Do not mount or unmount it manually.
hd	Error	87	Creating of mount point was failed. (%1)	Failed to create the mount point.	Check mount point has been specified in the cluster configuration data.  Check if the mount point exists.
hd	Error	89	Command failed. (%1)	Failed to run the system command.	Check if mount, unmount and fsck commands exist.
hd	Error	90	Failed to be current server.	Current priority cannot be acquired.	Check if hybrid disk resource is activated.  If the hybrid disk is being recovered or current priority is being processed in another server, wait for a while.

## Volume manager resources

Module Type	Type	Return value	Message	Description	Solution
volmgr	Error	4	Invalid Config.	The cluster configuration information is invalid.	Check if the cluster configuration information is consistent.
volmgr	Error	10	Already Imported.	The target has already been imported.	Check the target has been exported before startup of the cluster.
volmgr	Error	11	Other Host Imported.(host=%1)	The target has already been imported by host %1.	Check whether the target has been exported before startup of the cluster.
volmgr	Error	12 14	Command("%1") Error.(cmdret=%2)	Command %1 failed. The return value of the command is %2.	Analyze the error by the return value of the command.
volmgr	Error	Other	Internal Error.(ret=%1)	Another internal error occurred.	Memory or OS resources may not be sufficient. Check them.

## VM resources

Module Type	Type	Return value	Message	Description	Solution
vm	Error	1 to 6,8	Initialize error occurred.	An error was detected while initialization.	Check if the cluster configuration information is correct.
vm	Error	7	Parameter is invalid.	The parameter is invalid.	Check if the cluster configuration information is correct.
vm	Error	9 to 13	Failed to %s virtual machine %s.	Failed to control the virtual machine.	Check the status of the virtual machine.
vm	Error	22	Datastore must be setted.	The datastore name must be set for the Builder.	Click the <b>Details</b> tab of VM Resources Properties in the Builder, enter the name of data store containing the virtual machine configuration information to <b>Data Store Name</b> . And then click <b>Apply the Configuration File</b> .
vm	Error	23	VM configuration file path must be setted.	The VM configuration file path must be set for the Builder.	Click the <b>Details</b> tab of VM Resources Properties in the Builder, enter the path where the virtual machine configuration information is stored to <b>VM Configuration File Path</b> . And then click <b>Apply the Configuration File</b> .

Module Type	Type	Return value	Message	Description	Solution
vm	Error	Other	Internal error occurred.	Another internal error occurred.	Memory or OS resources may not be sufficient. Check them.

## Dynamic DNS resources

Module Type	Type	Return value	Message	Description	Solution
ddns	Error	1	Initialize error.	An error was detected during initialization.	There might not be enough memory space or OS resources. Check whether this is so.
ddns	Error	2	open() failed.(err=%1)	Opening the internally used file failed.	There might not be enough memory space or OS resources. Check whether this is so.
ddns	Error	3	write() failed.(err=%1)	Writing to the internally used file failed.	There might not be enough memory space or OS resources. Check whether this is so.
ddns	Error	4	closed() failed.(err=%1)	Closing the internally used file failed.	There might not be enough memory space or OS resources. Check whether this is so.
ddns	Error	5	nsupdate command has failed(%1).	Executing the nsupdate command failed.	Analyze the error by referring to the command return value.
ddns	Error	90	Memory allocation error.(err=%1)	An internal memory allocation error occurred.	There might not be enough memory space or OS resources. Check whether this is so.
ddns	Error	92	Time out.	An internal timeout was detected.	The OS might be heavily loaded. Check whether this is so.
ddns	Error	Other	Internal error.(status=%d)	A different internal error occurred.	There might not be enough memory space or OS resources. Check whether this is so.

## AWS elastic ip resources

Module Type	Type	Return value	Message	Description	Solution
awseip	Error	5	Failed in the AWS CLI command.	Failed in the AWS CLI command.	Check if the settings in the AWS CLI file are correct.
awseip	Error	5	The allocation ID '%1' does not exist	The specified EIP ALLOCATION ID %1 does not exist.	Check if the value of EIP ALLOCATION ID is correct.
awseip	Error	5	The networkInterface ID '%1' does not exist)	The specified ENI ID %1 does not exist.	Check if the value of ENI ID is correct.
awseip	Error	6	Timeout occurred.	Timeout occurred.	Check the load status of the server and remove the load.

Module Type	Type	Return value	Message	Description	Solution
awseip	Error	7	ENI ID is invalid.(ENI ID=%1)	ENI ID is invalid.	Check if the ENI ID is correct. Check if ENI ID of other instance is specified mistakenly
awseip	Error	99	Internal error. (status=%1)	An internal error occurred.	Check if Python is installed correctly. Check if AWS CLI is installed correctly. Memory or OS resources may not be sufficient. Check them.

## AWS virtual ip resources

Module Type	Type	Return value	Message	Description	Solution
awsvip	Error	5	Failed in the AWS CLI command.	Failed in the AWS CLI command.	Check if the settings in the AWS CLI file are correct.
awsvip	Error	5	The vpc ID '%1' does not exist	The specified VPC ID %1 does not exist.	Check if the value of VPC ID is correct.
awsvip	Error	5	The networkInterface ID '%1' does not exist)	The specified ENI ID %1 does not exist.	Check if the value of ENI ID is correct.
awsvip	Error	6	Timeout occurred.	Timeout occurred.	Check the load status of the server and remove the load.
awsvip	Error	7	The VIP address %1 belongs to a VPC subnet.	The VIP address %1 belongs to a VPC subnet.	For the VIP address, an IP address not belonging to a VPC subnet must be specified. Check the VIP address.
awsvip	Error	8	Failed to add the VIP address %1.	Failed to add the VIP address %1.	Check the VIP settings. Memory or OS resources may not be sufficient. Check them.
awsvip	Error	9	Failed to delete the VIP address %1.	Failed to delete the VIP address %1.	Memory or OS resources may not be sufficient. Check them.
awsvip	Error	10	The VIP address %1 is already used.	The VIP address %1 is already used.	Check if the VIP address is already used.
awsvip	Error	11	ENI ID is invalid.(ENI ID=%1)	ENI ID is invalid.	Check if the ENI ID is correct. Check if ENI ID of other instance is specified mistakenly.

Module Type	Type	Return value	Message	Description	Solution
awsvip	Error	99	Internal error. (status=%1)	An internal error occurred.	<p>Check if Python is installed correctly.</p> <p>Check if AWS CLI is installed correctly.</p> <p>Memory or OS resources may not be sufficient. Check them.</p>

## Azure probe port resources

Module Type	Type	Return value	Message	Description	Solution
azurepp	Error	5	Probe port %1 is already used.	Probe port %1 is already used.	Check if the probe port is already opened on the local server.
azurepp	Error	6	Failed to open the probe port %1.	Releasing probe port %1 failed.	Memory or OS resources may not be sufficient. Check them.
azurepp	Error	7	Failed to close the probe port %1.	Closing probe port %1 failed.	Memory or OS resources may not be sufficient. Check them.
azurepp	Error	8	Failed to stop the probe port %1 control process.	Stopping probe port %1 control process failed.	<p>Memory or OS resources may not be sufficient. Check them.</p> <p>Reboot the OS.</p>
azurepp	Error	9	The probe port %1 control process has already started.	Probe port %1 control process is already started.	<p>Memory or OS resources may not be sufficient. Check them.</p> <p>Or, the immediately preceding deactivation may have failed. In that case, stop the cluster and forcibly terminate the probe port control process (clpazureppp) manually.</p>
azurepp	Error	10	Failed to start the probe port %1 control process.	Starting probe port %1 control process failed.	Memory or OS resources may not be sufficient. Check them.
azurepp	Error	99	Internal error. (status=%1)	An internal error has occurred.	Memory or OS resources may not be sufficient. Check them.

## Detailed info of monitor resource errors

### IP monitor resources

Module Type	Type	Return value	Message	Description	Solution
ipw	Error	1	Ping cannot reach. (ret=%1) IP=%2...	The packet by the ping command did not reach.	Check if you can ping the IP address. If you fail, check the status of the device that has the IP address or the network interface.
ipw	Error	2	Ping was failed. (ret=%1) IP=%2...	The ping command failed.	Memory or OS resources may not be sufficient. Check them.
ipw	Error	5	Ping was failed by timeout. IP=%s...	The ping command failed due to timeout.	The system may be heavily loaded, memory or OS resources may not be sufficient. Check them.
ipw	Error	6 8~21	Internal error. (status=%1)	An error other than the errors mentioned above has occurred.	Memory or OS resources may not be sufficient. Check them.
ipw	Error	7	Internal error. (status=%1)	Monitoring of the IP monitor resource failed by time out.	Memory or OS resources may not be sufficient. Check them.

### Disk monitor resources

Module Type	Type	Return value	Message	Description	Solution
diskw	Error	11	Option was invalid.	The option is invalid.	Check the cluster configuration data by using the Builder.
diskw	Error	12	ioctl was failed. (err=%1) Device=%2	Failed to control the device.	Check the disk to be monitored is properly connected, powered on, or does not have any problem.
diskw	Error	13	ioctl was failed by timeout. Device=%1	The device control failed due to timeout.	Check the disk to be monitored is properly connected, powered on, or does not have any problem. The system may be heavily loaded, memory or OS resources may not be sufficient. Check them.
diskw	Error	14	Open was failed. (err=%1) File=%2	Opening the file failed.	Check if there is a directory whose name is similar to the file name, the disk to be monitored

Module Type	Type	Return value	Message	Description	Solution
			Open was failed. (err=%1) Device=%2	Opening the device failed.	is properly connected, powered on, or does not have any problem. Memory or OS resources may not be sufficient. Check them.
diskw	Error	15 48	Open was failed by timeout. File=%1	Opening the file failed due to timeout.	Check the disk to be monitored is properly connected, powered on, or does not have any problem.
			Open was failed by timeout. Device=%1	Opening the device failed due to timeout.	The system may be heavily loaded, memory or OS resources may not be sufficient. Check them.
diskw	Error	16	Read was failed. (err=%1) Device=%2	Failed to read from the device.	Check the disk to be monitored is properly connected, powered on, or does not have any problem. Memory or OS resources may not be sufficient. Check them.
diskw	Error	17	Read was failed by timeout. Device=%1	Failed to read from the device due to timeout.	Check the disk to be monitored is properly connected, powered on, or does not have any problem. The system may be heavily loaded, memory or OS resources may not be sufficient. Check them.
diskw	Error	18	Write was failed. (err=%1) File=%2	Writing to the file failed.	Check the disk to be monitored is properly connected, powered on, or does not have any problem. Memory or OS resources may not be sufficient. Check them.
diskw	Error	19	Write was failed by timeout. File=%1	Writing to the file failed due to timeout.	Check the disk to be monitored is properly connected, powered on, or does not have any problem. The system may be heavily loaded, memory or OS resources may not be sufficient. Check them.



Module Type	Type	Return value	Message	Description	Solution
diskw	Error	22	Internal error. (status=%1)	An error other than the errors mentioned above has occurred.	Memory or OS resources may not be sufficient. Check them.
		23			
		24			
		25			
		26			
		27			
		28			
		29			
		30			
		31			
		32			
		34			
		40			
43					
44					
diskw	Error	41	SG_IO failed. (sg_io_hdr_t info:%1 SG_INFO_OK_MASK: %2)	SG_IO failed.	Check the disk to be monitored is properly connected, powered on, or does not have any problem.
diskw	Error	42	Parameter was invalid. File=%1	The specified file name is invalid.	Do not specify the file whose name starts with /dev. Specify a normal file.
diskw	Error	47	Device was invalid. Device=%1	The specified real device is invalid.	Check the device name of the disk monitor resource on the Builder.
diskw	Error	49	Already bound for other. Rawdevice=%1 Device=%2	The RAW device has already been bound by another real device.	The set RAW device has already been bound by another real device. Change the RAW device name on the Builder.
diskw	Error	50	Popen was failed. (err=%1)	Popen failed.	Popen failed. Memory or OS resources may not be sufficient. Check them.
diskw	Error	51	Bind was failed. Rawdevice=%1 Device=%2	Bind failed.	Bind failed. Memory or OS resources may not be sufficient. Check them.
diskw	Error	52	Stat was failed. (err=%1) Device=%2	Stat failed.	Stat failed. Memory or OS resources may not be sufficient. Check them.
Diskw	Warning	100	Ignored disk full error.	A disk full error has been ignored.	Check the usage of the device.

## PID monitor resources

Module Type	Type	Return value	Message	Description	Solution
pidw	Error	1	Resource %1 was not found.	The resource is not found.	Check the cluster configuration data by using the Builder.
pidw	Error	1	Process does not exist. (pid=%1)	The process does not exist.	The process to be monitored disappeared for some reason.
pidw	Error	1	Internal error. (status=%1)	An error other than the errors mentioned above has occurred.	Memory or OS resources may not be sufficient. Check them.

## User-mode monitor resources

Module Type	Type	Return value	Message	Description	Solution
userw	Error	1	Initialize error. (%1)	An error was detected while initializing the process.	Check if the driver depended on by the user-mode monitor resources exist, or the rpm is installed. The driver or rpm differ depending on the monitor method.

## Custom monitor resource

Module Type	Type	Return value	Message	Description	Solution
genw	Error	1	Initialize error. (status=%d)	An error was detected while initialization.	Memory or OS resources may not be sufficient. Check them.
genw	Error	2	Termination code %d was returned.	An unexpected value was returned.	Check if the cluster configuration information is correct.
genw	Error	3	User was not superuser.	User was not root user.	Log in as root user.
genw	Error	4	Getting of config was failed.	Failed to get the cluster configuration information.	Check if the cluster configuration information exists.
genw	Error	5	Parameter was invalid.	The parameter is invalid.	Check if the cluster configuration information is correct.
genw	Error	6	Option was invalid.	The parameter is invalid.	Check if the cluster configuration information is correct.
genw	Error	7	Monitor Resource %s was not found.	The resource was not found.	Check if the cluster configuration information is correct.

genw	Error	8	Create process failed.	Create process failed.	Memory or OS resources may not be sufficient. Check them.
genw	Error	9	Process does not exist. (pid=%d)	The process did not exist.	Check if the process exists.
genw	Error	10	Process aborted. (pid=%d)	The process did not exist.	Check if the process exists.
genw	Error	11	Asynchronous process does not exist. (pid=%d)	The process did not exist.	Check if the process exists.
genw	Error	12	Asynchronous process aborted. (pid=%d)	The process did not exist.	Check if the process exists.
genw	Error	13	Monitor path was invalid.	The path is invalid.	Check if the cluster configuration information is correct.
genw	Error	others	Internal error. (status=%d)	Another internal error occurred.	-

### Multi target monitor resources

Module Type	Type	Return value	Message	Description	Solution
mtw	Error	1	Option was invalid.	The parameter is invalid.	Check if the cluster configuration information is correct.
mtw	Error	2	User was not superuser.	User was not root user.	Log in as root user.
mtw	Error	3	Internal error. (status=%d)	Another internal error occurred.	-

### Mirror disk monitor resources

Module Type	Type	Return value	Message	Description	Solution
mdw	Error	1	The Mirror Agent has not started.	The Mirror Agent is not activated.	Check the Mirror Agent is active.
mdw	Error	2	Invalid option or parameter.	The parameter is invalid.	Check the cluster configuration data is correct.
mdw	Error	4	Failed to obtain the cluster configuration information.	Failed to obtain the cluster configuration data.	Check the cluster configuration data exists.
mdw	Error	5	The configuration information of the mirror disk monitor resource is invalid.(%s)	The configuration data of the mirror disk monitor resource is incorrect.	Check if the cluster configuration data is correct.
mdw	Error	30	Internal error	An error other than the errors mentioned above has occurred.	Memory or OS resources may not be sufficient. Check them.

Module Type	Type	Return value	Message	Description	Solution
mdw	Error	51	Failed to obtain the remote server status.	Failed to get the other server status.	Check if the Mirror Agent is activated on the remote server.  Check mirror disk connection status. Check if the IP address in the cluster configuration data is correct.
mdw	Error	52	The mirror driver of the remote server is not working.	The remote server cannot be connected because it is stopped, or the mirror driver on the remote server has a problem.	Restart the remote server.  This is not an issue if the remote server is intentionally disconnected like being stopped.
mdw	Error	53	The mirror driver of the local server is not working.	The mirror driver on the local server has a problem.	Restart the local server.
mdw	Error	54	Both local and remote drivers are not working.	The mirror drivers on the local and remote servers have a problem.	After cluster shutdown, restart the both servers.
mdw	Error	58	Local mirror disk is unknown or not constructed.(%1)	The mirror disk status is unknown on the local server, or the initial mirror construction is not performed yet.	You have to perform the initial mirror construction.
mdw	Error	63	Local mirror disk is abnormal. (%1)	The mirror disk has a problem on the local server.	The local server does not have the latest data. The mirror recovery needs to be performed.
mdw	Error	64	Remote mirror disk is abnormal.(%1)	Mirror disk is abnormal on the remote server.	The remote server does not have the latest data. The mirror recovery needs to be performed.
mdw	Error	65	Both local and remote mirror disks are abnormal.(%1)	The mirror drivers on the local and remote servers have a problem.	The forcible mirror recovery needs to be performed.
mdw	Error	66	The mirror disk resource was activated on both servers.(%1)	Mirror disk resources have been activated on both servers.	When activation of mirror disk resource is detected on both servers, the servers shut down automatically. Restart the servers.  See the description for the module type rc and event ID 92 in "Messages reported by syslog, alert, mail, and SNMP trap" on page 1416 and "Recovery from network partitioning" on page 1299 for details.

Module Type	Type	Return value	Message	Description	Solution
mdw	Error	99	monitor was timeout	Response to the mirror disk monitor resource has timed out.  If this error has occurred in the mirror disk monitor resource, there may be a delay in communication between the mirror agents or in the disk I/O with the cluster partition.	Increase the transmission timeout setting for communication between mirror agents.  Also, if the timeout setting for the mirror disk monitor resource is smaller than the transmission timeout setting for communication between the mirror agents, adjust the settings so that the former is larger than the latter.
mdw	Warning	100	The mirror recovery is in progress. (%1)	Mirror recovery is in progress.	Wait until mirror recovery is successfully completed.

### Mirror disk connect monitor resources

Module Type	Type	Return value	Message	Description	Solution
mdnw hdnw	Error	1	The Mirror Agent has not started.	The Mirror Agent is not activated.	Check the Mirror Agent is active.
mdnw hdnw	Error	2	Invalid option or parameter.	The parameter is invalid	Check the cluster configuration data is correct.
mdnw hdnw	Error	4	Failed to obtain the cluster configuration information.	Failed to obtain the cluster configuration data.	Check the cluster configuration data exists.
mdnw hdnw	Error	5	The configuration information of the mirror disk monitor resource is invalid.(%s)	The configuration data of the mirror disk connect monitor resource is incorrect.	Check the cluster configuration data is correct.
mdnw hdnw	Error	30	Internal error[status=%1]	An error other than the errors mentioned above has occurred.	Memory or OS resources may not be sufficient. Check them.
mdnw hdnw	Error	31	The network is disconnected.	The mirror disk connection is not connected.	Check the mirror disk connection status.
mdnw	Warning	101	One of the mirror disk connection is disconnected.	Among the multiple mirror disk connections that exist, some were disconnected.	Check the mirror disk connection starts.

### JVM monitor resources

Module Type	Type	Return value	Message	Description	Solution
jraw	Error	11	An error was detected in accessing the monitor target.	Java VM to be monitored cannot be connected.	Check that the Java VM to be monitored is running.

Module Type	Type	Return value	Message	Description	Solution
jraw	Error	12	JVM status changed to abnormal. cause = %1.	An error was detected in monitoring Java VM. %1: Error generation cause C-Heap GarbageCollection JavaMemoryPool Thread WorkManagerQueue WebOTXStall	Based on the message, check the Java application that is running on Java VM to be monitored.
jraw	Error	99	Internal error occurred.	An internal error has occurred.	Execute cluster suspend and cluster resume.

## System monitor resources

Module Type	Type	Return value	Message	Description	Solution
sraw	Error	11	Detected an error in monitoring system resource	An error was detected when monitoring system resources.	There may be an error with the resources. Check them.

## Hybrid disk monitor resources

Module Type	Type	Return value	Message	Description	Solution
hdw	Error	1	The Mirror Agent has not started.	The Mirror Agent is not activated.	Check the Mirror Agent is active.
hdw	Error	2	Invalid option or parameter.	The parameter is invalid.	Check the cluster configuration data is correct.
hdw	Error	4	Failed to obtain the cluster configuration information.	Failed to obtain the cluster configuration data.	Check the cluster configuration data exists.
hdw	Error	5	The configuration information of the hybrid disk monitor resource is invalid.(%s)	The configuration data of the mirror disk monitor resource is incorrect.	Check if the cluster configuration data is correct.
hdw	Error	13	Both hybrid disks are pending.	Mirror status of both servers is pending.	Confirm the mirror status. Execute full mirror recovery, forced recovery or resource activation.
hdw	Error	15	Local hybrid disk is pending. Remote hybrid disk status is unknown.	Status of hybrid disk of other server cannot be acquired. Local server is pending. It cannot be specified which server has the latest data.	Check the inter connect. When it is confirmed that the local server has the latest data, activate the resource in the local server. When it is confirmed that the other server has the latest data, start the other server and activate the resource in the server.

Module Type	Type	Return value	Message	Description	Solution
hdw	Error	30	Internal error	An error other than the errors mentioned above has occurred.	Memory or OS resources may not be sufficient. Check them.
hdw	Error	51	Failed to obtain the remote server status.	Failed to get the other server status.	Check if the Mirror Agent is activated on the remote server. Check mirror disk connection status. Check if the IP address in the cluster configuration data is correct.
hdw	Error	52	The mirror driver of the remote server is not working.	The remote server cannot be connected because it is stopped, or the mirror driver on the remote server has a problem.	Restart the remote server. This is not an issue if the remote server is intentionally disconnected like being stopped.
hdw	Error	53	The mirror driver of the local server is not working.	The mirror driver on the local server has a problem.	Restart the local server.
hdw	Error	54	Both local and remote drivers are not working.	The mirror drivers on the local and remote servers have a problem.	After cluster shutdown, restart the both servers.
hdw	Error	58	Local hybrid disk is unknown or not constructed.(%1)	The hybrid disk status is unknown on the local server, or the initial mirror construction is not performed yet.	You have to perform the initial mirror construction.
hdw	Error	63	Local hybrid disk is abnormal.(%1)	The hybrid disk has a problem on the local server.	The local server does not have the latest data. The mirror recovery needs to be performed.
hdw	Error	64	Remote hybrid disk is abnormal.(%1)	Hybrid disk is abnormal on the remote server.	The remote server does not have the latest data. The mirror recovery needs to be performed.
hdw	Error	65	Both local and remote hybrid disks are abnormal.(%1)	The hybrid drivers on the local and remote servers have a problem.	The forcible mirror recovery needs to be performed.

Module Type	Type	Return value	Message	Description	Solution
hdw	Error	66	The hybrid disk resource was activated on both servers.(%1)	Hybrid disk resources have been activated on both servers.	When activation of mirror disk resource is detected on both servers, the servers shut down automatically. Restart the servers.  See the description for the module type rc and event ID 92 in “Messages reported by syslog, alert, mail, and SNMP trap” on page 1416 and “Recovery from network partitioning” on page 1299 for details.
hdw	Error	99	monitor was timeout	Response to the hybrid disk monitor resource has timed out.  If this error has occurred in the hybrid disk monitor resource, there may be a delay in communication between the mirror agents or in the disk I/O with the cluster partition.	Increase the transmission timeout setting for communication between mirror agents.  Also, if the timeout setting for the hybrid disk monitor resource is smaller than the transmission timeout setting for communication between the mirror agents, adjust the settings so that the former is larger than the latter.
hdw	Warning	100	The mirror recovery is in progress. (%1)	Mirror recovery is in progress.	Wait until mirror recovery is successfully completed.

## Hybrid disk connect monitor resources

Module Type	Type	Return value	Message	Description	Solution
hdnw	Error	1	The Mirror Agent has not started.	The Mirror Agent is not activated.	Check the Mirror Agent is active.
hdnw	Error	2	Invalid option or parameter.	The parameter is invalid	Check the cluster configuration data is correct.
hdnw	Error	4	Failed to obtain the cluster configuration information.	Failed to obtain the cluster configuration data.	Check the cluster configuration data exists.
hdnw	Error	5	The configuration information of the hybrid disk monitor resource is invalid.(%s)	The configuration data of the mirror disk connect monitor resource is incorrect.	Check the cluster configuration data is correct.
hdnw	Error	30	Internal error[status=%1]	An error other than the errors mentioned above has occurred.	Memory or OS resources may not be sufficient. Check them.



Module Type	Type	Return value	Message	Description	Solution
hdnw	Error	31	The network is disconnected.	The mirror disk connection is not connected.	Check the mirror disk connection status.
hdnw	Warning	101	One of the hybrid disk connection is disconnected.	The mirror disk connection is not connected.	Check the mirror disk connection status.

## NIC link up/down monitor resources

Module Type	Type	Return value	Message	Description	Solution
miiw	Error	1	Option was invalid.	The option is invalid.	Check the cluster configuration data by using the Builder.
miiw	Error	4	Config was invalid. (err=%1) %2	The cluster configuration data is invalid.	Check the cluster configuration data by using the Builder.
miiw	Error	10	Get address information was failed. (err=%1)	Failed to obtain the socket address of the IPv4 or IPv6 address family.	Check if the kernel configuration supports the TCP/IP networking (IPv4 or IPv6).
miiw	Error	11	Socket creation was failed. (err=%1)	Failed to create a socket.	Memory or OS resources may not be sufficient. Check them.
miiw	Error	12	ioctl was failed. (err=%1) Device=%2 Request=%3	The control request to the network driver has failed.	Check the network driver supports the control request of %3. See Chapter 5, "Monitor resource details" of this guide.
miiw	Error	13	MII was not supported or no such device. Device=%1	Either MII is not supported by NIC or the monitoring target does not exist.	See Chapter 5, "Monitor resource details" of this guide. Check the network interface name using a command such as ifconfig if the monitoring target does not exist.
miiw	Error	20	NIC %1 link was down.	NIC link failed.	Check that the LAN cable is connected properly
miiw	Error	98	Internal error. (status=%d)	Other internal error has occurred.	-

## ARP monitor resources

Module Type	Type	Return value	Message	Description	Solution
arpw	Error	1	Initialize error.	A failure was detected during initialization.	Memory or OS resources may not be sufficient. Check them.

arpw	Error	2	Not found IP address.	Could not find the IP address.	Check the status of a resource to be monitored.
arpw	Error	3	Socket creation error.	An error occurred in creating a socket.	Memory or OS resources may not be sufficient. Check them.
arpw	Error	4	Socket I/O error.	A failure occurred in control request to the network driver.	-
arpw	Error	5	Packet send error.	Failed to send ARP packet.	Check if packets can be sent from the IP address using such as the ping command.
arpw	Error	90	Memory allocate error.	Failed to allocate the internal memory.	Memory or OS resources may not be sufficient. Check them.
arpw	Error	92	Timeout.	Timeout has occurred in monitoring.	-

## Virtual IP monitor resources

Module Type	Type	Return value	Message	Description	Solution
vipw	Error	1	Initialize error.	A failure was detected during initialization.	Memory or OS resources may not be sufficient. Check them.
vipw	Error	2	Invalid interface. (err=%1)	Interface name of NIC is invalid.	Check the cluster configuration information using the Builder. Or check the interface name of NIC exists.
vipw	Error	3	Get IP Address information error. (err=%1)	Failed to acquire the socket address of IPv4 or IPv6 address family.	Check that the kernel configuration supports TCP/IP networking (IPv4 or IPv6).
vipw	Error	4	Socket creation error. (err=%1)	Failed to create a socket.	Memory or OS resources may not be sufficient. Check them.
vipw	Error	5	Socket option error. (err=%1)	Failed to set the socket option.	Memory or OS resources may not be sufficient. Check them.
vipw	Error	6	Socket bind error. (err=%1)	Failed to bind a socket with the IP address from which a socket is sent.	Check the cluster configuration information using the Builder. Or check the interface name of NIC exists.
vipw	Error	7	Socket I/O error. (err=%1)	Failed in control request to network driver.	Memory or OS resources may not be sufficient. Check them.
vipw	Error	8	Packet send error. (err=%1)	Failed to send RIP packet.	Check if packet can be sent from the IP address using such as the ping command.

Module Type	Type	Return value	Message	Description	Solution
vipw	Error	90	Memory allocation error. (err=%1)	Failed to allocate internal memory.	Memory or OS resources may not be sufficient. Check them.
vipw	Error	92	Timeout.	Timeout occurred in monitoring.	-
vipw	Error	98	Internal error. (status=%1)	Other internal error occurred.	-

## VM monitor resources

Module Type	Type	Return value	Message	Description	Solution
vmw	Error	1	initialize error occurred.	An error was detected while initialization.	Memory or OS resources may not be sufficient. Check them.
vmw	Error	11	monitor success, virtual machine is not running.	Stop of the virtual machine was detected.	Check the status of the virtual machine.
vmw	Error	12	failed to get virtual machine status.	Failed to get the status of the virtual machine.	Check if the virtual machine exists.
vmw	Error	13	timeout occurred.	The monitoring timed out.	The OS may be highly loaded. Check it.

## Volume manager monitor resources

Module Type	Type	Return value	Message	Description	Solution
volmgrw	Warning	100	%1 %2 is %3 !	The status of the target (%2) of the volume manager (%1) transferred to %3.	Check the status of the volume manager target.
volmgrw	Error	10	Command was failed. Command=%1	%1 command failed.	The command failed. Check the action status of the volume manager.
volmgrw	Error	11	Option was invalid.	The option is invalid.	Check the cluster configuration information on the Builder.
volmgrw	Error	Others	Internal error. (status=%1)	Another internal error occurred.	-

## Dynamic DNS monitor resources

Module Type	Type	Return value	Message	Description	Solution
ddnsw	Error	1	Initialize error.	An error was detected during initialization.	There might not be enough memory space or OS resources. Check whether this is so.
ddnsw	Error	2	open() failed.(err = %1)	Opening the internally used file failed.	There might not be enough memory space or OS resources. Check whether this is so.

Module Type	Type	Return value	Message	Description	Solution
ddnsw	Error	3	write() failed.(err = %1)	Writing to the internally used file failed.	There might not be enough memory space or OS resources. Check whether this is so.
ddnsw	Error	4	close() failed.(err = %1)	Closing the internally used file failed.	There might not be enough memory space or OS resources. Check whether this is so.
ddnsw	Error	5	nsupdate command has failed.	Executing the nsupdate command failed.	Analyze the error by referring to the command return value.
ddnsw	Error	6	Ping can not reach the DNS server(%1).	There was no ping response from the DNS server (%1).	Check the DNS server status.
ddnsw	Error	7	nslookup command has failed.	Executing the nslookup command failed.	Check the DNS server status.
ddnsw	Error	8	Ping can not reach virtual host(%1).	There was no ping response from the virtual host (%1).	Check the DNS server status.
ddnsw	Error	90	Memory allocation error.(err=%1)	An internal memory allocation error occurred.	There might not be enough memory space or OS resources. Check whether this is so.
ddnsw	Error	92	Time out.	Monitoring timed out.	The OS might be heavily loaded. Check whether this is so.
ddnsw	Error	Other	Internal error.(status=%d)	A different internal error occurred.	There might not be enough memory space or OS resources. Check whether this is so.

## Process name monitor resources

Module Type	Type	Return value	Message	Description	Solution
psw	Error	11	Process[%1 (pid=%2)] Down	Deletion of a monitored process has been detected.	Check whether the monitored process is running normally.
psw	Error	12	Process count check error. Process count %1/%2 (%3)	The number of started processes for the monitor target process is less than the specified minimum count.	Check whether the monitored process is running normally.
psw	Error	13 to 51	Initialize error	An error has been detected during initialization.	Check the following possible causes: memory shortage or OS resource insufficiency.
psw	Error	13 to 51	Internal error	An internal error has occurred.	Check the following possible causes: memory shortage or OS resource insufficiency.
psw	Error	200	Monitoring timeout	Monitoring has timed out.	The OS may be highly loaded. Check that.

## BMC monitor resource

Module Type	Type	Return value	Message	Description	Solution
-------------	------	--------------	---------	-------------	----------

Module Type	Type	Return value	Message	Description	Solution
bmcw	Error	0	Success.	The monitoring process was successful.	
bmcw	Error	1	Initialize error.	An error occurred when the monitor started.	Check the following possible causes: memory shortage, OS resource insufficiency, or failure to install the IPMI driver correctly.
bmcw	Error	32	Not supported platform. (code=%1)	The platform is not supported.	The hardware may be other than the NX7700x series.
bmcw	Error	32	BMC access denied.	The IPMI command for monitoring failed.	Check the operating status of the IPMI driver.
bmcw	Error	64	Internal error. (status=%1)	An internal error occurred.	Check the following possible causes: memory shortage or OS resource insufficiency.
bmcw	Warning	128	The registered license is invalid. (%1)	The registered license is invalid.	Register a valid license.
bmcw	Warning	129	The license is not registered. (%1)	The license is not registered.	Purchase and register a license.
bmcw	Warning	130	The trial license has expired in %.4s/%.2s/%.2s. (%1)	The trial license has expired.	Register a valid license.
bmcw	Warning	130	The trial license is valid from %.4s/%.2s/%.2s. (%1)	The current date is earlier than the valid period of the trial license.	Register a valid license.
bmcw	Warning	131	The registered license is unknown. (%1)	The registered license is unknown.	Register a valid license.
bmcw	Error	200	Timeout.	Monitoring caused a timeout.	The BMC is highly loaded or has stalled. Check the BMC.

## Oracle Clusterware Synchronization Management monitor resource

Module Type	Type	Return value	Message	Description	Solution
osmw	Error	1	Initialize error.	An error occurred when the monitor started.	Check the following possible causes: memory shortage, OS resource insufficiency, or failure to install the IPMI driver correctly.
osmw	Error	1	Oracle Clusterware linkage is not enabled.	Oracle Clusterware linkage function is not enabled.	Enable the Oracle Clusterware linkage function.
osmw	Error	32	All registered Oracle processes do not exist.	A process of any watch targets doesn't exist.	Everything of a watch target process became extinct by some cause. Please check Oracle Clusterware processes.

Module Type	Type	Return value	Message	Description	Solution
osmw	Error	64	Internal error. (status=%1)	An internal error occurred.	Check the following possible causes: memory shortage or OS resource insufficiency.
osmw	Warning	128	The registered license is invalid. (%1)	The registered license is invalid.	Register a valid license.
osmw	Warning	129	The license is not registered. (%1)	The license is not registered.	Purchase and register a license.
osmw	Warning	130	The trial license has expired in %.4s/%.2s/%.2s. (%1)	The trial license has expired.	Register a valid license.
osmw	Warning	131	The trial license is valid from %.4s/%.2s/%.2s. (%1)	The current date is earlier than the valid period of the trial license.	Register a valid license.
osmw	Warning	132	The registered license is unknown. (%1)	The registered license is unknown.	Register a valid license.
osmw	Warning	160	Some registered Oracle processes do not exist.	A process of some watch targets doesn't exist.	Some of the watch target process became extinct by some cause. Please check Oracle Clusterware processes.
osmw	Error	200	Timeout.	Monitoring caused a timeout.	The OS may be highly loaded. Check that.

## Floating IP monitor resources

Module Type	Type	Return value	Message	Description	Solution
fipw	Error	1	User is not superuser.	The user does not have the root user right.	The user who executed the operation may not have the root user right. Or, memory or OS resources may not be sufficient. Check them.
fipw	Error	2	Parameter is invalid.	The parameter is invalid.	Check if the cluster configuration data is correct.
fipw	Error	3	Failed to get the value from cluster configuration data.	Failed to get the value from cluster configuration data.	Check if the cluster configuration data is correct.
fipw	Error	4	IP address does not exist.	The IP address does not exist.	NIC may have been disabled. Check if the FIP address exists with the ifconfig command or the ip command.

Module Type	Type	Return value	Message	Description	Solution
fipw	Error	5	Adapter Index is different.	The adapter index is different.	NIC may have been disabled. Check if the FIP address exists with the ifconfig command or the ip command.
fipw	Error	6	Failed to get IP address table.	Failed to get the IP address list.	Memory or OS resources may not be sufficient. Check them.
fipw	Error	7	Failed to get NIC interface name.	Failed to get the NIC interface name.	Memory or OS resources may not be sufficient. Check them.
fipw	Error	8	Failed to get NIC status.	Failed to get the NIC status.	Check if the NIC device is supported by the device I/O controller.
fipw	Error	9	Detected NIC Link Down.	Link Down of NIC was detected.	Check if the LAN cable is connected properly.
fipw	Error	10	Timeout occurred.	A timeout occurred.	Check the load status of the server and remove the load.
fipw	Error	99	Internal error occurred. (status=%d)	An internal error occurred.	Memory or OS resources may not be sufficient. Check them.

## AWS elastic ip monitor resources

Module type	Type	Return value	Message	Description	Solution
awseipw	Error	5	Failed in the AWS CLI command.	Failed in the AWS CLI command.	Check if the settings in the AWS CLI file are correct.
awseipw	Error	6	Timeout occurred.	Timeout occurred.	Check the load status of the server and remove the load.
awseipw	Error	7	The EIP address does not exist. (EIP ALLOCATION ID=%1)	The EIP address %1 does not exist.	The EIP may have been detached. Check it.
awseipw	Error	99	Internal error. (status=%1)	Internal error occurred.	Check if Python is installed correctly. Check if AWS CLI is installed correctly. Memory or OS resources may not be sufficient. Check them.
awseipw	Warning	105	Failed in the AWS CLI command.	Failed in the AWS CLI command.	Check if the settings in the AWS CLI file are correct.
awseipw	Warning	106	Timeout occurred.	Timeout occurred.	Check the load status of the server and remove the load.

## AWS virtual ip monitor resources

Module type	Type	Return value	Message	Description	Solution
awsvipw	Error	5	Failed in the AWS CLI command.	Failed in the AWS CLI command.	Check if the settings in the AWS CLI file are correct.
awsvipw	Error	6	Timeout occurred.	Timeout occurred.	Check the load status of the server and remove the load.
awsvipw	Error	7	The VIP address %1 does not exist.	The VIP address %1 does not exist.	NIC may have been disabled. Check if the VIP address exists with the ipconfig command.
awsvipw	Error	8	The routing for VIP %1 was changed.	The routing for VIP %1 was changed.	The VIP routing may have been changed. Check the Route Tables of the VPC.
awsvipw	Error	99	Internal error. (status=%1)	Internal error occurred.	Check if Python is installed correctly. Check if AWS CLI is installed correctly. Memory or OS resources may not be sufficient. Check them.
awsvipw	Warning	105	Failed in the AWS CLI command.	Failed in the AWS CLI command.	Check if the settings in the AWS CLI file are correct.
awsvipw	Warning	106	Timeout occurred.	Timeout occurred.	Check the load status of the server and remove the load.

## AWS AZ monitor resources

Module type	Type	Return value	Message	Description	Solution
awsazw	Error	4	Failed to monitor the availability zone %1	Failed to monitor the availability zone %1.	The availability zone to which the server belongs may have a problem. Check it.
awsazw	Error	5	Failed in the AWS CLI command.	Failed in the AWS CLI command.	Check if the settings in the AWS CLI file are correct.
awsazw	Error	5	Invalid availability zone: [%1]	The specified availability zone %1 does not exist.	Check if the settings of the availability zone are correct.
awsazw	Error	6	Timeout occurred.	Timeout occurred.	Check the load status of the server and remove the load.



Module type	Type	Return value	Message	Description	Solution
awsazw	Error	99	Internal error. (status=%1)	Internal error occurred.	Check if Python is installed correctly. Check if AWS CLI is installed correctly. Memory or OS resources may not be sufficient. Check them.
awsazw	Warning	105	Failed in the AWS CLI command.	Failed in the AWS CLI command.	Check if the settings in the AWS CLI file are correct.
awsazw	Warning	105	Invalid availability zone: [%1]	The specified availability zone %1 does not exist.	Check if the settings of the availability zone are correct.
awsazw	Warning	106	Timeout occurred.	Timeout occurred.	Check the load status of the server and remove the load.

### Azure probe port monitor resources

Module type	Type	Return value	Message	Description	Solution
azureppw	Error	4	Probe port %1 is closed.	Probe port is closed.	Probe port is closed. Please confirm the setting of a network of a server.
azureppw	Error	5	Timeout of waiting probe port %1 occurred.	Timeout of waiting probe port occurred.	A probe from a load balancer of Azure couldn't be received in the timeout of waiting probe port. Please confirm or whether a network is connected with whether an error doesn't occur by a network adapter right.
azureppw	Error	6	Monitoring probe port %1 failed.	Monitoring probe port failed.	Memory or OS resources may not be sufficient. Check them.
azureppw	Error	7	Monitoring probe port %1 is frozen.	Monitoring probe port is frozen.	Memory or OS resources may not be sufficient. Check them.
azureppw	Error	99	Internal error. (status=%1)	Internal error occurred.	Memory or OS resources may not be sufficient. Check them.

Module type	Type	Return value	Message	Description	Solution
azureppw	Warning	105	Timeout of waiting probe port %1 occurred.	Timeout of waiting probe port occurred.	A probe from a load balancer of Azure couldn't be received in the timeout of waiting probe port. Please confirm or whether a network is connected with whether an error doesn't occur by a network adapter right.

## Azure load balance monitor resources

Module type	Type	Return value	Message	Description	Solution
azurelbw	Error	4	On server %1, probe port %2 is opened.	On server, probe port is opened.	A probe port is opening by a standby server. Please make sure that the probe port won't be opened by a standby server.
azurelbw	Error	5	Monitoring probe port %1 failed.	Monitoring probe port failed.	Memory or OS resources may not be sufficient. Check them.
azurelbw	Error	99	Internal error. (status=%1)	Internal error occurred.	Memory or OS resources may not be sufficient. Check them.

## Monitoring option monitor resource

Monitor resources of monitoring options use common messages. Module types are different for each monitoring option monitor resource.

Monitoring option monitor resource	Module type
DB2 monitor resource	db2w
FTP monitor resource	ftpw
HTTP monitor resource	httpw
IMAP4 monitor resource	imap4w
MySQL monitor resource	mysqlw
NFS monitor resource	nfs
Oracle monitor resource	oracle
OracleAS monitor resource	oracleasw
POP3 monitor resource	pop3w
PostgreSQL monitor resource	psqlw
Samba monitor resource	sambaw
SMTP monitor resource	smtpw

Monitoring resource	option	monitor	Module type
Sybase monitor resource			sybasew
Tuxedo monitor resource			tuxw
Websphere monitor resource			wasw
Weblogic monitor resource			wlsw
WebOTX monitor resource			otwx

Module type	Type	Return value	Message	Description	Solution
(see the list above)	Error	1	Init error. [%1, ret=%2] %3: license/XML/log/share mem/library	license/XML/log/share memory module initialization error Failed in Dynamic Library Load.	OS may be heavily loaded. Check the status of OS.
(see the list above)	Error	2	Get config information error. [ret=%1]	Failed to acquire the setting information.	Check the cluster configuration information using the Builder.
(see the list above)	Error	3	Invalid parameter.	The setting information of Config file/Policy file is invalid. Command parameter is invalid.	Check the cluster configuration information using the Builder.
(see the list above)	Error	4	Detected function exception. [%1, ret=%2] %3: function name	A failure was detected.	Check the cluster configuration information using the Builder. The OS may be heavily loaded. Check it.
(see the list above)	Error	5	Failed to connect to %1 server. [ret=%2] %3:	Failed to connect to the monitor target. The actual module type is displayed in %1.	Check the status of the monitor target.
(see the list above)	Error	6	Detected authority error.	Failed in the user authentication.	Check the user name, password, and access right.
(see the list above)	Error	7	Failed to execute SQL statement (%1). [ret=%2] %3:	Failed to execute SQL statement (%1). The actual module type is displayed in %1.	Check the cluster configuration information using the Builder.
(see the list above)	Error	8	Failed to access with %1. %2:	Failed in data access with monitor target. The actual module type is displayed in %1.	Check the status of monitor target.
(see the list above)	Error	9	Detected error in %1. %2:	A failure occurred on monitor target. The actual module type is displayed in %1.	Check the status of monitor target.

Module type	Type	Return value	Message	Description	Solution
(see the list above)	Error	10	User was not superuser.	A user does not have the right as root user.	The user who executed the operation may not have a root user right. Or, memory or OS resources may not be sufficient. Check them.
(see the list above)	Error	11	Detected timeout error.	Communication timeout has occurred.	OS may be heavily loaded. Check it.
(see the list above)	Error	12	Can not found library. (libpath=%1, errno=%2)	Failed to load the library from the specified location.	Check where the library is located.
(see the list above)	Error	40	The license is not registered.	The license is not registered.	Check if the valid license is registered.
(see the list above)	Error	41	The registration license overlaps.	The registered license already exists.	Check if the valid license is registered.
(see the list above)	Error	42	The license is invalid.	The license is invalid.	Check if the valid license is registered.
(see the list above)	Error	43	The license of trial expired by %1. %2: <i>Validity_date</i>	The license of trial is expired. The actual validity date is displayed in <i>Validity_date</i> .	-
(see the list above)	Error	44	The license of trial effective from %1. %2: <i>Validity_date</i>	The trial license has not become effective yet. The actual validity date is displayed in <i>Validity_date</i> .	-
(see the list above)	Warning	71	Detected a monitor delay in monitoring %1. (timeout=%2*%3 actual-time=%4 delay warning rate=%5)	A monitoring delay was detected in monitoring %1. The current timeout value is %2 (second) x %3 (tick count per second). The actual measurement value at delay detection is %4 (tick count) and exceeded the delay warning rate %5 (%).	Check the load status of the server on which a monitoring delay was detected and remove the load. If a monitoring timeout is detected, extend it.
(see the list above)	Info	81	The collecting of detailed information triggered by monitor resource %1 error has been started (timeout=%2).	Collecting of detailed information triggered by the detection of a monitor resource \$1 monitoring error has started. The timeout is %2 seconds.	-
(see the list above)	Info	82	The collection of detailed information triggered by monitor resource %1 error has been completed.	Collecting of detailed information triggered by the detection of a monitor resource %1 monitoring error has been completed.	-

## Detailed info of monitor resource errors

Module type	Type	Return value	Message	Description	Solution
(see the list above)	Warning	83	The collection of detailed information triggered by monitor resource %1 error has been failed (%2).	Collecting of detailed information triggered by the detection of a monitor resource %1 monitoring error has failed. (%2)	-
(see the list above)	Error	99	Internal error. (status=%1)	An internal error was detected.	-

## JVM monitor resource log output messages

The following messages belong to the JVM operation and JVM load balancer linkage log files that are specific to the JVM monitor resources.

### JVM operation log

Message	Cause of generation	Action
Failed to write the %1\$s.stat.	Writing to the JVM statistics log has failed. %1\$s.stat: JVM statistics log file name	Check whether there is sufficient free disk space.
%1\$s: analyze finish[%4\$s]. state = %2\$s, cause = %3\$s	(When the status of the Java VM to be monitored is abnormal) the resource use amount has exceeded the threshold in the Java VM to be monitored. %1\$s: Name of the Java VM to be monitored %2\$s: Status of Java VM to be monitored (1=normal, 0=abnormal) %3\$s: Error generation location at abnormality occurrence %4\$s: Measurement thread name	Review the Java application that runs on the Java VM to be monitored.
thread stopped by UncaughtException.	The thread of the JVM monitor resource has stopped.	Execute cluster suspend/cluster resume and then restart the Java Resource Agent.
thread wait stopped by Exception.	The thread of the JVM monitor resource has stopped.	Execute cluster suspend/cluster resume and then restart the Java Resource Agent.
%1\$s: monitor thread can't connect to JVM.	The Java VM to be monitored could not be connected. %1\$s: Name of the Java VM to be monitored	Check that the Java VM to be monitored is running.
%1\$s: monitor thread can't get the JVM state.	The resource use amount could not be acquired from Java VM to be monitored. %1\$s: Name of the Java VM to be monitored	Check that the Java VM to be monitored is running.
%1\$s: JVM state is changed [abnormal -> normal].	The status of the Java VM to be monitored has changed from abnormal to normal. %1\$s: Name of the Java VM to be monitored	-
%1\$s: JVM state is changed [normal -> abnormal].	The status of the Java VM to be monitored has changed from normal to abnormal. %1\$s: Name of the Java VM to be monitored	Review the Java application that runs on the Java VM to be monitored.

Message	Cause of generation	Action
%1\$s: Failed to connect to JVM.	The Java VM to be monitored could not be connected. %1\$s: Name of the Java VM to be monitored	Check that the Java VM to be monitored is running.
Failed to write exit code.	The JVM monitor resource failed to write data to the file for recording the exit code.	Check whether there is sufficient free disk space.
Failed to be started JVMSaver.	Starting of the JVM monitor resource has failed.	Check the JVM operation log, remove the cause preventing the start, execute cluster suspend/cluster resume, and then restart the Java Resource Agent.
JVMSaver already started.	The JVM monitor resource has already been started.	Execute cluster suspend/cluster resume and then restart the Java Resource Agent.
%1\$s: GARBAGE_COLLECTOR_MXBEAN_DOMAIN_TYPE is invalid.	GC information could not be acquired from the Java VM to be monitored. %1\$s: Name of the Java VM to be monitored	Check whether the operating environment of the Java VM to be monitored is correct.
%1\$s: GarbageCollectorMXBean is invalid.	GC information could not be acquired from the Java VM to be monitored. %1\$s: Name of the Java VM to be monitored	Check whether the operating environment of the Java VM to be monitored is correct.
%1\$s: Failed to measure the GC stat.	GC information could not be acquired from the Java VM to be monitored. %1\$s: Name of the Java VM to be monitored	Check whether the operating environment of the Java VM to be monitored is correct.
%1\$s: GC stat is invalid. last.getCount = %2\$s, last.getTime = %3\$s, now.getCount = %4\$s, now.getTime = %5\$s.	The GC generation count and GC execution time could not be measured for the Java VM to be monitored. %1\$s: Name of the Java VM to be monitored %2\$s: GC generation count at last measurement %3\$s: Total GC execution time at last measurement %4\$s: GC generation count at this measurement %5\$s: Total GC execution time at this measurement	Check whether the operating environment of the Java VM to be monitored is correct.

Message	Cause of generation	Action
%1\$s: GC average time is too long. av = %6\$s, last.getCount = %2\$s, last.getTime = %3\$s, now.getCount = %4\$s, now.getTime = %5\$s.	The average GC execution time has exceeded the threshold in the Java VM to be monitored. %1\$s: Name of the Java VM to be monitored %2\$s: GC generation count at last measurement %3\$s: Total GC execution time at last measurement %4\$s: GC generation count at this measurement %5\$s: Total GC execution time at this measurement %6\$s: Average of the GC execution time used from the last measurement to this measurement	Review the Java application that runs on the Java VM to be monitored.
%1\$s: GC average time is too long compared with the last connection. av = %6\$s, last.getCount = %2\$s, last.getTime = %3\$s, now.getCount = %4\$s, now.getTime = %5\$s.	After the Java VM to be monitored was reconnected, the average of the GC execution time has exceeded the threshold in the Java VM to be monitored. %1\$s: Name of the Java VM to be monitored %2\$s: GC generation count at last measurement %3\$s: Total GC execution time at last measurement %4\$s: GC generation count at this measurement %5\$s: Total GC execution time at this measurement %6\$s: Average of the GC execution time used from the last measurement to this measurement	Review the Java application that runs on the Java VM to be monitored.
%1\$s: GC count is too frequently. count = %4\$s last.getCount = %2\$s, now.getCount = %3\$s.	The GC generation count has exceeded the threshold in the Java VM to be monitored. %1\$s: Name of the Java VM to be monitored %2\$s: GC generation count at last measurement %3\$s: GC generation count at this measurement %4\$s: GC generation count from the last measurement to this measurement	Review the Java application that runs on the Java VM to be monitored.



Message	Cause of generation	Action
%1\$s: GC count is too frequently compared with the last connection. count = %4\$s last.getCount = %2\$s, now.getCount = %3\$s.	After the Java VM to be monitored was reconnected, the GC generation count has exceeded the threshold in the Java VM to be monitored. %1\$s: Name of the Java VM to be monitored %2\$s: GC generation count at last measurement %3\$s: GC generation count at this measurement %4\$s: GC generation count from the last measurement to this measurement	Review the Java application that runs on the Java VM to be monitored.
%1\$s: RUNTIME_MXBEAN_NAME is invalid.	C heap information could not be acquired from the Java VM to be monitored. %1\$s: Name of the Java VM to be monitored	Check whether the operating environment of the Java VM to be monitored is correct.
%1\$s: RuntimeMXBean is invalid.	Information could not be acquired from the Java VM to be monitored. %1\$s: Name of the Java VM to be monitored	Check whether the operating environment of the Java VM to be monitored is correct.
%1\$s: Failed to measure the runtime stat.	Information could not be acquired from the Java VM to be monitored. %1\$s: Name of the Java VM to be monitored	Check whether the operating environment of the Java VM to be monitored is correct. Check whether the processing load is high in the Java VM to be monitored.
%1\$s: Process C-Heap capacity is too little. pname = %2\$s, pid = %4\$s, capacity = %3\$s.	The C heap free space has fallen below the threshold in the Java VM to be monitored. %1\$s: Name of the Java VM to be monitored %2\$s: Command line of the process to be monitored %3\$s: C heap free space %4\$s: ID of the process to be monitored	Review the Java application that runs on the Java VM to be monitored.
%1\$s: Failed to measure C-Heap capacity. stdout = %2\$s, stderr = %3\$s.	The C heap free space could not be measured in the Java VM to be monitored. %1\$s: Name of the Java VM to be monitored %2\$s: Standard output of the C heap measurement program %3\$s: Standard error output of the C heap measurement program	Check whether the machine load is high.

Message	Cause of generation	Action
%1\$s: Failed to measure C-Heap capacity. timeout at gap_chk.	The C heap free space could not be measured in the Java VM to be monitored due to a timeout. %1\$s: Name of the Java VM to be monitored	Check whether the machine load is high.
%1\$s: Failed to measure C-Heap capacity. execute error at gap_chk.stderr = %2\$s.	The C heap free space could not be measured in the Java VM to be monitored. %1\$s: Name of the Java VM to be monitored %2\$s: Standard error output of the C heap measurement program	Check whether the machine load is high.
%1\$s: Failed to measure C-Heap capacity. execute error at gap_chk.cause = %2\$s.	The C heap free space could not be measured in the Java VM to be monitored. %1\$s: Name of the Java VM to be monitored %2\$s: Detailed error information of C heap measurement program execution failure	Check whether the machine load is high.
%1\$s: MEMORY_MXBEAN_NAME is invalid. %2\$s, %3\$s.	Memory information could not be acquired from the Java VM to be monitored. %1\$s: Name of the Java VM to be monitored %2\$s: Memory pool name %3\$s: Memory name	Check whether the operating environment of the Java VM to be monitored is correct.
%1\$s: MemoryMXBean is invalid.	Memory information could not be acquired from the Java VM to be monitored. %1\$s: Name of the Java VM to be monitored	Check whether the operating environment of the Java VM to be monitored is correct.
%1\$s: Failed to measure the memory stat.	Memory information could not be acquired from the Java VM to be monitored. %1\$s: Name of the Java VM to be monitored	Check whether the operating environment of the Java VM to be monitored is correct. Check whether the processing load is high in the Java VM to be monitored.
%1\$s: MemoryPool name is undefined. memory_name = %2\$s.	Memory information could not be acquired from the Java VM to be monitored. %1\$s: Name of the Java VM to be monitored %2\$s: Name of the Java memory pool to be measured	Check whether the operating environment of the Java VM to be monitored is correct.

Message	Cause of generation	Action
%1\$s: MemoryPool capacity is too little. memory_name = %2\$s, used = %3\$s, max = %4\$s, ratio = %5\$s%.	The Java memory pool free space has fallen below the threshold in the Java VM to be monitored. %1\$s: Name of the Java VM to be monitored %2\$s: Name of the Java memory pool to be measured %3\$s: Use amount of the Java memory pool %4\$s: Maximum usable amount of the Java memory pool %5\$s: Use rate of the Java memory pool	Review the Java application that runs on the Java VM to be monitored.
%1\$s: THREAD_MXBEAN_NAME is invalid.	Thread information could not be acquired from the Java VM to be monitored. %1\$s: Name of the Java VM to be monitored	Check whether the operating environment of the Java VM to be monitored is correct.
%1\$s: ThreadMXBean is invalid.	Thread information could not be acquired from the Java VM to be monitored. %1\$s: Name of the Java VM to be monitored	Check whether the operating environment of the Java VM to be monitored is correct.
%1\$s: Failed to measure the thread stat.	Thread information could not be acquired from Java VM to be monitored. %1\$s: Name of the Java VM to be monitored	Check whether the operating environment of the Java VM to be monitored is correct.
%1\$s: Detect Deadlock. threads = %2\$s.	Thread deadlock has occurred in the Java VM to be monitored. %1\$s: Name of the Java VM to be monitored %2\$s: ID of the deadlock thread	Review the Java application that runs on the Java VM to be monitored.
%1\$s: Thread count is too much(%2\$s).	The number of activated threads has exceeded the threshold in the Java VM to be monitored. %1\$s: Name of the Java VM to be monitored %2\$s: Number of activated threads at measurement	Review the Java application that runs on the Java VM to be monitored.
%1\$s: ThreadInfo is null.Thread count = %2\$s.	Thread information could not be acquired in the Java VM to be monitored. %1\$s: Name of the Java VM to be monitored %2\$s: Number of activated threads at measurement	Check whether the operating environment of the version of the Java VM to be monitored is correct.
%1\$s: Failed to disconnect.	Disconnection from the Java VM to be monitored has failed. %1\$s: Name of the Java VM to be monitored	-

Message	Cause of generation	Action
%1\$s: Failed to connect to WebLogicServer.	WebLogic Server to be monitored could not be connected. %1\$s: Name of the Java VM to be monitored	Review the Java application that runs on the WebLogic Server to be monitored.
%1\$s: Failed to connect to Sun JVM.	Java VM and WebOTX to be monitored could not be connected. %1\$s: Name of the Java VM to be monitored	Review the Java application that runs on the Java VM and WebOTX to be monitored.
Failed to open the %1\$s.	The JVM statistics log could not be output. %1\$s: Name of the HA/JVMSaverJVM statistics log file	Check whether the disk has sufficient free space or whether the number of open files has exceeded the upper limit.
%1\$s: Can't find monitor file.	No monitoring %1\$s: Name of the Java VM to be monitored	-
%1\$s: Can't find monitor file, monitor stopped[thread:%2\$s].	Monitoring stops. %1\$s: Name of the Java VM to be monitored %2\$s: Type of the measurement thread	-
%1\$s: Failed to create monitor status file.	An internal file could not be created. %1\$s: Name of the Java VM to be monitored	Check whether the disk free space and the maximum number of volume files are sufficient.
%1\$s: Failed to delete monitor status file.	An internal file could not be deleted. %1\$s: Name of the Java VM to be monitored	Check whether there is a problem with the hard disk.
%1\$s: com.bea.Type=ServerRuntime is invalid.	Information could not be acquired from the Java VM to be monitored. %1\$s: Name of the Java VM to be monitored	Check whether the operating environment of the Java VM to be monitored is correct.
%1\$s: WorkManagerRuntimeMBean or ThreadPoolRuntimeMBean is invalid.	Information could not be acquired from the WebLogic Server to be monitored. %1\$s: Name of the Java VM to be monitored	Check whether the operating environment of the WebLogic Server to be monitored is correct.
%1\$s: Failed to measure the WorkManager or ThreadPool stat.	Information could not be acquired from the WebLogic Server to be monitored. %1\$s: Name of the Java VM to be monitored	Check whether the operating environment of the WebLogic Server to be monitored is correct.

Message	Cause of generation	Action
%1\$s: ThreadPool stat is invalid. last.pending = %2\$s, now.pending = %3\$s.	The number of waiting requests could not be measured in the thread pool of the WebLogic Server to be monitored. %1\$s: Name of the Java VM to be monitored %2\$s: Number of waiting requests at last measurement %3\$s: Number of waiting requests at this measurement	Check whether the operating environment of the version of the WebLogic Server to be monitored is correct.
%1\$s: WorkManager stat is invalid. last.pending = %2\$s, now.pending = %3\$s.	The number of waiting requests could not be measured in the work manager of the WebLogic Server to be monitored. %1\$s: Name of the Java VM to be monitored %2\$s: Number of waiting requests at last measurement %3\$s: Number of waiting requests at this measurement	Check whether the operating environment of the version of the WebLogic Server to be monitored is correct.
%1\$s: PendingRequest count is too much. count = %2\$s.	The number of waiting requests has exceeded the threshold in the thread pool of the WebLogic Server to be monitored. %1\$s: Name of the Java VM to be monitored %2\$s: Number of waiting requests at this measurement	Review the Java application that runs on the WebLogic Server to be monitored.
%1\$s: PendingRequest increment is too much. increment = %4\$s%, last.pending = %2\$s, now.pending = %3\$s.	The increment of the number of waiting requests has exceeded the threshold in the thread pool of the WebLogic Server to be monitored. %1\$s: Name of the Java VM to be monitored %2\$s: Number of waiting requests at last measurement %3\$s: Number of waiting requests at this measurement %4\$s: Increment of the number of waiting requests from the last measurement to this measurement	Review the Java application that runs on the WebLogic Server to be monitored.

Message	Cause of generation	Action
%1\$s: PendingRequest increment is too much compared with the last connection. increment = %4\$s, last.pending = %2\$s, now.pending = %3\$s.	After the WebLogic Server to be monitored was reconnected, the increment of the number of waiting requests has exceeded the threshold in the thread pool of the WebLogic Server to be monitored. %1\$s: Name of the Java VM to be monitored %2\$s: Number of waiting requests at last measurement %3\$s: Number of waiting requests at this measurement %4\$s: Increment of the number of waiting requests from the last measurement to this measurement	Review the Java application that runs on the WebLogic Server to be monitored.
%1\$s: Throughput count is too much. count = %2\$s.	The number of requests executed per unit time has exceeded the threshold in the thread pool of the WebLogic Server to be monitored. %1\$s: Name of the Java VM to be monitored %2\$s: Number of requests executed per unit time at this measurement	Review the Java application that runs on the WebLogic Server to be monitored.
%1\$s: Throughput increment is too much. increment = %4\$s, last.throughput = %2\$s, now.throughput = %3\$s.	The increment of the number of requests executed per unit time has exceeded the threshold in the thread pool of the WebLogic Server to be monitored. %1\$s: Name of the Java VM to be monitored %2\$s: Number of requests executed per unit time at last measurement %3\$s: Number of requests executed per unit time at this measurement %4\$s: Increment of the number of requests executed per unit time from the last measurement to this measurement	Review the Java application that runs on the WebLogic Server to be monitored.

Message	Cause of generation	Action
<p>%1\$: Throughput increment is too much compared with the last connection. increment = %4\$, last.throughput = %2\$, now.throughput = %3\$.</p>	<p>After the WebLogic Server to be monitored was reconnected, the increment of the number of requests executed per unit time has exceeded the threshold in the thread pool of the WebLogic Server to be monitored.                      %1\$: Name of the Java VM to be monitored                      %2\$: Number of requests executed per unit time at last measurement                      %3\$: Number of requests executed per unit time at this measurement                      %4\$: Increment of the number of requests executed per unit time from the last measurement to this measurement</p>	<p>Review the Java application that runs on the WebLogic Server to be monitored.</p>
<p>%1\$: PendingRequest count is too much. appName = %2\$, name = %3\$, count = %4\$.</p>	<p>The number of waiting requests has exceeded the threshold in the work manager of the WebLogic Server to be monitored.                      %1\$: Name of the Java VM to be monitored                      %2\$: Application name                      %3\$: Work manager name                      %4\$: Number of waiting requests</p>	<p>Review the Java application that runs on the WebLogic Server to be monitored.</p>
<p>%1\$: PendingRequest increment is too much. appName = %2\$, name = %3\$, increment = %6\$, last.pending = %4\$, now.pending = %5\$.</p>	<p>The increment of the number of waiting requests has exceeded the threshold in the work manager of the WebLogic Server to be monitored.                      %1\$: Name of the Java VM to be monitored                      %2\$: Application name                      %3\$: Work manager name                      %4\$: Number of waiting requests at last measurement                      %5\$: Number of waiting requests at this measurement                      %6\$: Increment of the number of waiting requests from the last measurement to this measurement</p>	<p>Review the Java application that runs on the WebLogic Server to be monitored.</p>

Message	Cause of generation	Action
%1\$s: PendingRequest increment is too much compared with the last connection. AppName = %2\$s, Name = %3\$s, increment = %6\$s, last.pending = %4\$s, now.pending = %5\$s.	After the WebLogic Server to be monitored was reconnected, the increment of the number of waiting requests has exceeded the threshold in the work manager of the WebLogic Server to be monitored. %1\$s: Name of the Java VM to be monitored %2\$s: Application name %3\$s: Work manager name %4\$s: Number of waiting requests at last measurement %5\$s: Number of waiting requests at this measurement %6\$s: Increment of the number of waiting requests from the last measurement to this measurement	Review the Java application that runs on the WebLogic Server to be monitored.
%1\$s: Can't find WorkManager. appName = %2\$s, name = %3\$s.	The work manager which was set could not be acquired from the WebLogic Server. %1\$s: Name of the Java VM to be monitored %2\$s: Application name %3\$s: Work manager name	Review the setting of <b>Target WebLogic Work Managers</b> .
%1\$s: analyze of average start[%2\$s].	Analyzing of the average value has started. %1\$s: Name of the Java VM to be monitored %2\$s: Thread name	-
%1\$s: analyze of average finish[%2\$s].state = %3\$s.	Analyzing of the average value has been completed. %1\$s: Name of the Java VM to be monitored %2\$s: Thread name %3\$s: Status of the target to be monitored	-
%1\$s: Average of PendingRequest count is too much. count = %2\$s.	The average of the number of waiting requests has exceeded the threshold in the thread pool of the WebLogic Server to be monitored.  %1\$s: Name of the Java VM to be monitored %2\$s: Number of waiting requests at this measurement	Review the Java application that runs on the WebLogic Server to be monitored.



Message	Cause of generation	Action
%1\$s: Average of Throughput count is too much. count = %2\$s.	The average of the number of requests executed per unit time has exceeded the threshold in the thread pool of the WebLogic Server to be monitored. %1\$s: Name of the Java VM to be monitored %2\$s: Number of requests executed per unit time at this measurement	Review the Java application that runs on the WebLogic Server to be monitored.
%1\$s: Average of PendingRequest count is too much. AppName = %2\$s, Name = %3\$s, count = %4\$s.	The average of the number of waiting requests has exceeded the threshold in the work manager of the WebLogic Server to be monitored. %1\$s: Name of the Java VM to be monitored %2\$s: Application name %3\$s: Work manager name %4\$s: Number of waiting requests at this measurement	Review the Java application that runs on the WebLogic Server to be monitored.
Error: Failed to operate clpbra_bigip.[%1\$s]	%1\$s: Error code	Review the setting.
action thread execution did not finish. action is alive = %1\$s.	Execution of [Command] has timed out. %1\$s: Executable file name specified by [Command]	Forcibly terminate [Command] . Review [Command timeout]. Remove the cause of the timeout, such as a high load.
%1\$s: Failed to connect to Local JVM. cause = %2\$s.	Failed to establish connection to JBoss. %1\$s: Monitor target name %2\$s: Detailed cause of the failure  The detailed cause is one of the following. <ul style="list-style-type: none"> <li>Failed to found tool.jar, please set jdk's path for the java path.</li> <li>Load tool.jar exception</li> <li>Get Local JVM url path exception</li> <li>Failed to get process name</li> <li>Failed to connect to JBoss JVM.</li> </ul>	Review [Java Installation Path] and [Process Name]. Specify JDK, instead of JRE, as [Java Installation Path]. Check whether JBoss has started.

## JVM load balancer linkage log

Message	Cause of generation	Action
lbadmin command start.	Execution of the load balancer linkage command has started.	-

Message	Cause of generation	Action
lbadm command finish.	Execution of the load balancer linkage command has been completed.	-
Into HealthCheck mode.	The health check function is enabled.	-
Into Weight mode.	The load calculation function of the Java VM to be monitored is valid.	-
The PID of lbadm.jar is "%1".	ID of the process relating to the load balancer linkage %1: Process ID of lbadm.jar	-
Thread wait stopped by Exception	Waiting for down judgment has been stopped.	-
Rename Command succeeded.	Renaming of the HTML file has been successful.	-
Rename Command failed.	Renaming of the HTML file has failed.	Check the HTML file name and HTML rename destination file name.
%1 doesn't exist.	The rename source HTML file does not exist. %1: HTML file name	Check the HTML file name.
%1 already exists.	The rename destination HTML file already exists. %1: HTML rename destination file name	Check the HTML rename destination file name.
Can't rename file:%1.	Renaming of the HTML file has failed. %1: HTML file name	Check the HTML rename destination file name.
The number of retries exceeded the limit.	The retry count for renaming the HTML file has exceeded the upper limit.	Check the HTML rename destination file name.
The percent of the load is "%1".	Load calculation for the Java VM to be monitored has been successful. %1: Load of Java VM to be monitored	-
stat log (%1) doesn't exist.	There is no JVM statistics log file. %1: JVM statistics log file name	Execute cluster suspend/cluster resume and then restart the Java Resource Agent.
stat log(%1:) cannot be opened for reading.	The JVM statistics log file could not be opened. %1: JVM statistics log file name	Execute cluster suspend/cluster resume and then restart the Java Resource Agent.
format of stat log (%1) is wrong.	The contents of the JVM statistics log file are invalid. %1: JVM statistics log file name	After deleting the JVM statistics log file, execute cluster suspend/cluster resume and then restart the Java Resource Agent.
Failed to get load of application server.	Data for load calculation could not be acquired from the JVM statistics log file.	Review whether the load calculation setting of the Java VM to be monitored is correct.
Can't find lock file(%1s*.stat.lck), maybe HA/JVMSaver did not start yet.	JVM monitoring has not yet started. %1: Internal file name	Start the JVM monitoring.

# Appendix

- Appendix A Glossary
- Appendix B Index



---

# Appendix A Glossary

<b>C heap</b>	Memory area used by Java VM itself
<b>GC</b>	Abbreviation for garbage collection
<b>Java heap</b>	Area in which the Java VM allocates memory according to a memory acquisition request from a Java application. Target of GC
<b>Java memory pool</b>	Memory area prepared by the Java VM for Java applications
<b>JMX</b>	Abbreviation for Java Management Extensions. Specification used for Java that manages and monitors the hardware and software in the network
<b>JVM operation log</b>	File for recording JVM monitoring operation information. The file is created in the following location: <EXPRESSCLUSTER_install_path>/log/ha/jra/jragent*.log * (* indicates a number starting at 0.)
<b>JVM statistics log</b>	File for recording statistics obtained from JVM monitoring. The file is created in the following location: <EXPRESSCLUSTER_install_path>/log/ha/jra/*.stat
<b>JVM load balancer linkage log</b>	File for recording the load balancer linkage operation information obtained from JVM monitoring. The file is created in the following location: <EXPRESSCLUSTER_install_path>/log/ha/jra/lbadmin.log
<b>Interconnect</b>	A dedicated communication path for server-to-server communication in a cluster. (Related terms: Private LAN, Public LAN)
<b>Virtual IP address</b>	IP address used to configure a remote cluster.
<b>Management client</b>	Any machine that uses the WebManager to access and manage a cluster system.
<b>Startup attribute</b>	A failover group attribute that determines whether a failover group should be started up automatically or manually when a cluster is started.
<b>Shared disk</b>	A disk that multiple servers can access.
<b>Shared disk type cluster</b>	A cluster system that uses one or more shared disks.
<b>Switchable partition</b>	A disk partition connected to multiple computers and is switchable among computers. (Related terms: Disk heartbeat partition)
<b>Cluster system</b>	Multiple computers are connected via a LAN (or other network) and behave as if it were a single system.

<b>Cluster shutdown</b>	To shut down an entire cluster system (all servers that configure a cluster system).
<b>Cluster partition</b>	A partition on a mirror disk or a hybrid disk. Used for managing mirror disks or hybrid disks. (Related term: Disk heartbeat partition)
<b>Active server</b>	A server that is running for an application set. (Related term: Standby server)
<b>Secondary server</b>	A destination server where a failover group fails over to during normal operations. (Related term: Primary server)
<b>Standby server</b>	A server that is not an active server. (Related term: Active server)
<b>Disk heartbeat partition</b>	A partition used for heartbeat communication in a shared disk type cluster.
<b>Data partition</b>	A local disk that can be used as a shared disk for switchable partition. Data partition for mirror disks or hybrid disks. (Related term: Cluster partition)
<b>Network partition</b>	All heartbeat is lost and the network between servers is partitioned. (Related terms: Interconnect, Heartbeat)
<b>Node</b>	A server that is part of a cluster in a cluster system. In networking terminology, it refers to devices, including computers and routers, that can transmit, receive, or process signals.
<b>Heartbeat</b>	Signals that servers in a cluster send to each other to detect a failure in a cluster. (Related terms: Interconnect, Network partition)
<b>Public LAN</b>	A communication channel between clients and servers. (Related terms: Interconnect, Private LAN)
<b>Failover</b>	The process of a standby server taking over the group of resources that the active server previously was handling due to error detection.
<b>Failback</b>	A process of returning an application back to an active server after an application fails over to another server.
<b>Failover group</b>	A group of cluster resources and attributes required to execute an application.
<b>Moving failover group</b>	Moving an application from an active server to a standby server by a user.
<b>Failover policy</b>	A priority list of servers that a group can fail over to.

---

<b>Private LAN</b>	LAN in which only servers configured in a clustered system are connected. (Related terms: Interconnect, Public LAN)
<b>Primary (server)</b>	A server that is the main server for a failover group. (Related term: Secondary server)
<b>Floating IP address</b>	Clients can transparently switch one server from another when a failover occurs. Any unassigned IP address that has the same network address that a cluster server belongs to can be used as a floating address.
<b>Master server</b>	Server displayed on top of the <b>Master Server</b> in <b>Server Common Properties</b> in the Builder
<b>Mirror disk connect</b>	LAN used for data mirroring in mirror disk or hybrid disk. Mirror connect can be used with primary interconnect.
<b>Mirror disk type cluster</b>	A cluster system that does not use a shared disk. Local disks of the servers are mirrored.





---

# Appendix B Index

## A

- Activation and deactivation error of recovery target, 852
- Adding a cluster, 1255
- Adding a server, 1356
- Adding an object, 165
- Adding servers, 1255
- Adjusting time-out temporarily, 438
- Advanced settings of user- mode monitoring, 941
- Alert Log tab, 212
- alert messages, 1240
- Alert service, 1239
- Alert Service tab, 198
- Alert view fields, 85
- Alert view operation, 87
- ARP monitor resources, 1533, 964
- Attributes common to group resources, 566
- automatic startup prohibition, 1248
- Automatically recovering from mirroring, 1390
- AWS AZ monitor resources, 1540, 1192
- AWS elastic ip monitor resources, 1539, 1184
- AWS elastic ip resource, 802
- AWS elastic ip resources, 1520, 802
- AWS virtual ip monitor resources, 1540, 1188
- AWS virtual ip resource, 807
- AWS virtual ip resources, 1521, 807
- Azure load balance monitor resources, 1200
- Azure load balance monitor resources, 1542
- Azure probe port monitor resources, 1196
- Azure probe port monitor resources, 1541
- Azure probe port resource, 813
- Azure probe port resources, 1522, 813
- Azure probe port resources, and Azure probe port monitor resources, and Azure load balance monitor resources, 1260

## B

- Behavior when an error is detected, 834, 848, 855
- BMC, 883
- BMC heartbeat resources, 1205, 1215
- BMC information change command, 550
- BMC monitor resource, 1536
- BMC tab, 235
- BMC(High-End Server Option) tab, 237
- Bonding, 1228

## C

- Canceling access restriction, 107
- Cautions, 888
- Change the settings without using the WebManager, 111
- Changing a current server, 109, 515
- Changing current server on hybrid disk, 1405
- Changing current server with a command, 1405
- Changing current server with WebManager, 1405
- Changing disk resources file system, 1333

- Changing offset or size of a partition on hybrid disk resource, 1345
- Changing offset or size of a partition on mirror disk resource, 1335
- Changing the host name, 1362
- Changing the name of a monitor resource, 872
- Changing the screen layout, 38, 40
- Changing the server configuration, 1279, 1356
- Changing the server IP address, 1360
- Chassis identify, 1237
- Chassis identify control command, 542
- Checking alerts, 27, 30, 32, 85
- Checking availability, 944
- Checking the cluster status, 27, 30, 76
- Checking the mirror break status from the WebManager, 1400
- Checking the mirror break status with a command, 1390
- Checking the mirror recovery progress from the WebManager, 1401
- Checking the mirror recovery progress with a command, 1392
- Checking the status of each object, 27, 30, 42
- Checking the status of individual server in the WebManager list view, 83
- Checking the status of the whole monitor in the WebManager list view, 84
- Checking the time information, 39
- Checking the whole status of the server, 82
- checkingthe process health, 295, 558
- clplamp, 539
- Cluster configuration information backup command, 424
- Cluster driver device information, 1295
- Cluster properties, 169
- Cluster shutdown, 116
- Cluster shutdown reboot, 116
- Collecting information at emergency OS shutdown, 415
- Collecting logs, 295, 408
- Collecting logs by specifying a type, 411
- Collecting logs by using the WebManager, 35
- colors of the icons, 43
- COM heartbeat resources, 1214
- Command that displays status, 303
- Common settings for the monitor resources of the monitoring option, 887
- Communication ports, 1292
- Conditions under which the mirror status becomes abnormal, 729
- Configuration and range, 912
- Configuring the settings to temporarily prevent execution of failover, 1301
- confirmation test for startup, 887
- Confirming the license, 41
- Consideration for using the Builder, 143
- control the group resource, 552
- Controlling group resources, 531
- Controlling monitor resources, 295, 523
- Controlling path, 693
- CPU frequency control command, 540

CPU usage, 1175  
 Creating a cluster, 417, 1255  
 Creating a group, 1256  
 Creating a monitor resource, 1256  
 Creating a new cluster, 155, 164  
 Creating cluster configuration information, 1251, 1253  
 custom monitor resources, 969

## D

DB2 monitor resources, 1006  
 DDNS resource, 796  
 DDNS resources, 795  
 Delay warning of monitor resources, 864  
 Delay Warning tab, 213  
 Deleting a server, 1358, 1359  
 dependencies of AWS elastic ip resources, 802  
 dependencies of AWS virtual ip resources, 807  
 dependencies of Azure probe port resources, 813  
 Dependencies of DDNS resources, 795  
 Dependencies of disk resource, 660  
 Dependencies of floating IP resource, 674  
 Dependencies of hybrid disk resource, 747  
 Dependencies of mirror disk resource, 706  
 Dependencies of the NAS resource, 763  
 Dependencies of virtual IP resources, 688  
 Dependencies of VM resources, 783  
 Dependencies of volume manager resources, 771  
 Dependency of EXEC resources, 624  
 Detailed info in activating and deactivating group resources, 1511  
 Detailed info of monitor resource errors, 1523  
 Details on the Builder screen, 145  
 Determining virtual IP address, 690  
 Directory structure of EXPRESSCLUSTER, 1280  
 Disconnecting a mirror disk, 108  
 Disk heartbeat resources, 1212  
 Disk I/O lockout command, 456  
 Disk I/O Lockout tab, 238  
 disk monitor resources, 889  
 Disk monitor resources, 1523  
 disk resource, 660  
 Disk Resource Tuning Properties, 665, 670  
 Disk resources, 1512  
 Displaying a group map, 304  
 Displaying all configuration data, 389  
 displaying and changing AWS elastic ip resource details, 803  
 displaying and changing AWS virtual ip resource details, 809  
 Displaying and changing EXEC resource script, 654  
 Displaying and changing floating IP monitor resource details, 906  
 Displaying and changing IP monitor resource details, 901  
 Displaying and changing the ARP monitor resource details, 965  
 Displaying and changing the automatic startup prohibition setting, 1248  
 displaying and changing the AWS AZ monitor resource details, 1192  
 Displaying and changing the comment, 872  
 Displaying and changing the comment of a group,

591, 621  
 Displaying and changing the comment of a group resource, 605  
 Displaying and changing the custom monitor resource details, 970  
 Displaying and changing the DB2 monitor resource details, 1008  
 displaying and changing the details of Azure load balance monitor resources, 1200  
 displaying and changing the details of Azure probe port monitor resources, 1196  
 Displaying and changing the details of disk monitor resources, 894  
 Displaying and changing the details of disk resource, 663  
 Displaying and changing the details of floating IP resource, 681  
 Displaying and changing the details of hybrid disk resource, 758  
 Displaying and changing the details of mirror disk resource, 716, 731  
 Displaying and changing the details of NAS resource, 765  
 Displaying and changing the details of the DDNS resources, 799  
 Displaying and changing the details of the MultiTarget monitor resource, 955  
 Displaying and changing the details of the Process name monitor resources, 1001  
 Displaying and changing the details of the VM monitor resources, 993  
 Displaying and changing the details of the VM resources, 785  
 Displaying and changing the details of the volume manager monitor resources, 778, 978  
 Displaying and changing the details of virtual IP resource, 696  
 Displaying and changing the exec resource details, 649  
 Displaying and changing the EXEC resource script, 651  
 Displaying and changing the EXEC resource script created by the Builder, 653  
 Displaying and changing the FTP monitor resource details, 1014  
 Displaying and changing the group attribute, 594  
 Displaying and changing the HTTP monitor resource details, 1019  
 Displaying and changing the hybrid disk connect monitor resource details, 927  
 Displaying and changing the hybrid disk monitor resource details, 932  
 Displaying and changing the IMAP4 monitor resource details, 1024  
 displaying and changing the JVM monitor resource details, 1146  
 Displaying and changing the mirror disk connect monitor resource details, 918  
 Displaying and changing the mirror disk monitor resource details, 922  
 Displaying and changing the MySQL monitor resource details, 1030  
 Displaying and changing the NFS monitor resource details, 1036  
 Displaying and changing the NIC link up/down

---

monitor resource details, 913  
 Displaying and changing the operation settings, 609  
 Displaying and changing the Oracle monitor resource details, 1044  
 Displaying and changing the OracleAS monitor resource details, 1052  
 Displaying and changing the OracleAS monitor resource properties, 1054  
 Displaying and changing the POP3 monitor resource details, 1059  
 Displaying and changing the PostgreSQL monitor resource details, 1065  
 Displaying and changing the Samba monitor resource details, 1071  
 Displaying and changing the settings of a monitor resource, 873  
 Displaying and changing the settings of group properties, 591, 621  
 Displaying and changing the settings of group resources, 605  
 Displaying and changing the settings of server group that starts up the group, 593  
 Displaying and changing the settings of servers belonging to a server group, 622  
 Displaying and changing the settings of servers that starts up the group, 591  
 Displaying and changing the settings of the time when an error is detected by a monitor resource, 876, 945  
 Displaying and changing the shutdown monitoring, 1224  
 Displaying and changing the SMTP monitor resource details, 1076  
 Displaying and changing the Sybase monitor resource details, 1082  
 Displaying and changing the system monitor resource details, 1172  
 Displaying and changing the Tuxedo monitor resource details, 1088  
 Displaying and changing the user-mode monitor resource details, 947  
 Displaying and changing the Weblogic monitor resource details, 1093  
 Displaying and changing the WebOTX monitor resource details, 1105  
 Displaying and changing the Websphere monitor resource details, 1099  
 Displaying and configuring the settings of dependency among group resources, 607  
 Displaying and setting group start dependence and group stop dependence, 601  
 displaying Azure probe port resource properties, 815, 816  
 Displaying EXEC resource properties, 658  
 Displaying only the configuration data of a certain group resource, 321  
 Displaying only the configuration data of a certain monitor resource, 343  
 Displaying only the configuration data of certain groups, 320  
 Displaying only the configuration data of certain servers, 314  
 Displaying only the information of certain group, 319  
 Displaying the ARP monitor resource property, 966  
 displaying the AWS elastic ip resource properties, 805  
 displaying the AWS virtual ip resource properties, 811  
 displaying the Azure load balance monitor resource properties, 1201  
 displaying the Azure probe port monitor resource properties, 1197  
 Displaying the cluster configuration data, 308  
 Displaying the cluster status, 295, 299  
 Displaying the custom monitor resource properties, 974  
 Displaying the DB2 monitor resource properties, 1010  
 Displaying the detailed information on the whole cluster in a list by the WebManager, 76  
 displaying the details of Azure probe port resources, 814  
 Displaying the disk monitor resource properties, 897  
 Displaying the disk resource properties, 671  
 Displaying the floating IP monitor resource properties with the WebManager, 907  
 Displaying the FTP monitor resource properties, 1016  
 Displaying the HTTP monitor resource properties, 1020  
 Displaying the hybrid disk connect monitor resource property, 928  
 Displaying the hybrid disk resource property, 759  
 Displaying the IMAP4 monitor resource properties, 1026  
 Displaying the IP monitor resource property, 903  
 Displaying the JVM monitor resource properties, 1165  
 Displaying the mirror disk connect monitor resource property, 919  
 Displaying the mirror disk monitor resource property, 923, 933  
 Displaying the mirror disk resource property, 744  
 Displaying the MySQL monitor resource properties, 1032  
 Displaying the NFS monitor resource properties, 1038  
 Displaying the NIC link up/down monitor resource property, 914  
 Displaying the Oracle monitor resource properties, 1048  
 Displaying the PID monitor resource property, 937  
 Displaying the POP3 monitor resource properties, 1061  
 Displaying the PostgreSQL monitor resource properties, 1067  
 Displaying the process name monitor resource properties, 1002  
 Displaying the properties of a DDNS resource, 800  
 Displaying the properties of a VHOSTW monitor resource, 997  
 Displaying the properties of a VM monitor resource, 994  
 Displaying the properties of a VM resource, 791  
 Displaying the properties of a volume manager monitor resource, 979  
 Displaying the properties of a volume manager

resource, 781  
 Displaying the properties of PING network partition resolution resources, 1221  
 displaying the property of a AWS AZ monitor resource, 1193  
 displaying the property of a AWS elastic ip monitor resource, 1185  
 displaying the property of a AWS virtual ip monitor resource, 1189  
 Displaying the property of a certain group, 617  
 Displaying the property of a LAN heartbeat resource, 1207  
 Displaying the property of floating IP resource, 686  
 Displaying the property of kernel mode LAN heartbeat resources, 1209  
 Displaying the property of NAS resource, 769  
 Displaying the property of the BMC heartbeat resource, 1215  
 Displaying the property of the COM heartbeat resource, 1214  
 Displaying the property of the disk heartbeat resource, 1213  
 Displaying the property of the MultiTarget monitor resource, 958  
 Displaying the property of the whole groups, 617  
 Displaying the Samba monitor resource properties, 1073  
 Displaying the server group properties, 623  
 Displaying the SMTP monitor resource properties, 1077  
 Displaying the status of heartbeat resources, 306, 307  
 Displaying the status of monitor resources, 305  
 Displaying the Sybase monitor resource properties, 1084  
 Displaying the Tuxedo monitor resource properties, 1089  
 Displaying the user-mode monitor resource property, 950  
 Displaying the virtual IP monitor resource property, 961  
 Displaying the virtual IP resource properties with the WebManager, 704  
 Displaying the Weblogic monitor resource properties, 1095  
 Displaying the WebOTX monitor resource properties, 1108  
 Displaying the Websphere monitor resource properties, 1101  
 distributions, 940, 941  
 Downloading the configuration file, 157  
 Driver syslog messages, 1489  
 Drivers that user-mode monitor resources depend, 940  
 Duration Time, 288, 289, 1175, 1176, 1177

## E

Edit menu, 165  
 Emergency server shutdown, 1299  
 Enabling and disabling dummy failure of monitor resources, 828  
 Environment, 1208  
 environment variable, 580  
 environment variables, 860

Environment variables, 626  
 Error messages, 27, 118  
 Estimating the amount of resource usage, 295, 553  
 Example of the MultiTarget monitor resource configuration, 954  
 Examples of mirror disk construction, 719  
 Exclusion tab, 214  
 Exec resources, 1515  
 EXEC resources, 624  
 Executing command corresponding to cause of each detected error, 1132  
 Execution timing of exec resource script, 629  
 Exiting from the Builder, 163  
 Express5800/A1080a series, 982, 1223, 1250  
 EXPRESSCLUSTER commands, 297  
 EXPRESSCLUSTER versions, 564  
 External monitoring link processing request command, 546

## F

failover policy, 571  
 Failover to a server group at another site, 983  
 Failure in resuming the cluster, 1300  
 File menu, 154, 241  
 Final action, 1296, 1298  
 FIP resource, 1228  
 Floating IP, 674  
 Floating IP address resources, 1511  
 floating IP monitor resources, 905  
 Floating IP monitor resources, 1538  
 floating IP resource, 674  
 flow of describing a script before final action, 581  
 For an example of how to configure network partition resolution, 1262  
 forced stop action, 1298  
 Forcibly mounting mirror disk when mirroring is not available, 1382, 1386  
 FTP monitor resources, 1013  
 Functional differences of the Builder between Linux and Windows, 241

## G

GC operation status check on monitor target Java VM, 1125  
 GC tab, 1158  
 Group start dependence and group stop dependence, 587

## H

Heartbeat I/F tab, 171  
 Help menu, 168  
 How DB2 monitor resources perform monitoring, 1007  
 How HTTP monitor resources perform monitoring, 1018  
 How JVM monitor resources perform monitoring, 1111  
 How monitor user-mode monitor resources perform monitoring, 941  
 How MySQL monitor resources perform monitoring, 1029

---

How NFS monitor resources perform monitoring, 1035  
How Oracle monitor resources perform monitoring, 1043  
How OracleAS monitor resources perform monitoring, 1051  
How PostgreSQL monitor resources perform monitoring, 1064  
How process name monitor resources perform monitoring, 1001  
How Samba monitor resources perform monitoring, 1070  
How SMTP monitor resources perform monitoring, 1075  
How Sybase monitor resources perform monitoring, 1081  
How system monitor resources perform monitoring, 1168  
How to delete logs or alerts, 1279, 1285  
How to replace a server with a new one, 1279, 1311  
How Tuxedo monitor resources perform monitoring, 1087  
How Weblogic monitor resources perform monitoring, 1092  
How WebOTX monitor resources perform monitoring, 1104  
How Websphere monitor resources perform monitoring, 1098  
HTTP monitor resources, 1018  
hybrid disk, 748  
hybrid disk connect monitor resources, 926  
Hybrid disk connect monitor resources, 1532  
hybrid disk error, 1300  
hybrid disk monitor resources, 931  
Hybrid disk monitor resources, 1530  
Hybrid disk resource operation command, 500  
Hybrid disk resources, 1517  
Hybrid disk status display commands, 489  
Hybrid sources, 747  
Hybrid-disk-related commands, 489

## I

I/O size, 890, 892  
IMAP4 monitor resources, 1023  
Info tab, 169, 229  
Initializing hybrid disks, 295, 516  
Initializing mirror disks, 485  
Inter-cluster processing request command, 544  
IP monitor resources, 1523, 900  
ipmi command, 883, 945

## J

Java memory area usage check on monitor target  
Java VM, 1123  
Java memory pool name, 1127  
JVM load balancer linkage log, 1557  
JVM monitor resource log output messages, 1546  
JVM monitor resources, 1529, 1111  
JVM monitor tab, 219  
JVM operation log, 1546  
JVM statistics log, 1123

## K

Keepalive driver, 1509  
Kernel mode LAN heartbeat driver, 1507

## L

LAN heartbeat resources, 1207  
License management command, 451  
Limitations of the WebManager, 117  
Limitations on using the Builder, 144  
Limiting the number of reboots, 868  
linkage with the server management infrastructure, 1269  
linking with the load balancer, 1115, 1117  
list view, 76  
Load Balancer Linkage tab, 1162, 1163  
Log structure, 1283

## M

Mail report, 1240  
Manually running mkfs to mirror disk or hybrid disk, 1389  
Manually setting the stop and start of the WebManager, 110  
Memory tab, 1150, 1153, 1155  
Message output command, 520  
message receive monitor resources, 982, 1270  
Message receive monitor resources, 1271  
Messages, 1416  
Messages reported by syslog, alert, mail, and SNMP trap, 1416  
method of judging EXEC resource activation/deactivation results, 624  
Mirror Agent tab, 215  
Mirror connect, 1231  
mirror disk, 732  
Mirror disk, 706  
Mirror disk connect monitor resources, 1529  
Mirror disk error, 1300  
mirror disk helper, 116  
Mirror disk helper, 89  
mirror disk monitor resources, 922  
Mirror disk monitor resources, 1527  
mirror disk resource, 724  
Mirror disk resource, 116  
Mirror disk resource operation command, 470  
Mirror disk resources, 1516  
Mirror Driver, 1490  
Mirror driver tab, 217  
mirror parameter settings, 751  
mirror parameters, 710  
Mirror related commands, 458  
Mirror statistics information collection function, 1286  
Mirror status display commands, 458  
Modifying the log level and size, 441  
Monitor interval mechanism of monitor resource, 829  
Monitor priority of the monitor resources, 872  
monitor resource, 1165, 1180  
monitor resource, 1180  
monitor resource, 1180

Monitor resource, 821  
 monitor resources, 1172  
 Monitor tab, 185  
 Monitor timing of monitor resource, 825  
 Monitoring, 889, 900  
 Monitoring by custom monitor resources, 969  
 Monitoring by floating IP monitor resources, 905  
 monitoring duration, 1168, 1182, 1183  
 Monitoring duration, 1182  
 Monitoring iPlanet Web Server, 1145  
 Monitoring JBoss, 1141  
 Monitoring SVF, 1144  
 Monitoring Tomcat, 1143  
 Monitoring WebLogic Server, 1137  
 Monitoring WebOTX, 1139  
 mount processing flow, 727, 756  
 Mounting hybrid disks manually, 1385  
 Mounting mirror disks manually, 1381  
 multi target monitor resources, 953  
 Multi target monitor resources, 1527  
 MultiTarget Monitor resource status, 953  
 MySQL monitor resources, 1028

## N

NAS resource, 763  
 NAS resources, 1513  
 network configuration, 1255  
 Network configuration tab, 171  
 Network partitions, 1218  
 Network partition resolution, 1299  
 network partition resolution by PING method, 1220  
 Network Partition Resolution Definition tab, 176  
 network partition resolution resources, 1219, 1255  
 NFS monitor resources, 1035  
 NIC link up/down monitor resources, 1533, 910  
 NNDS resources, 797  
 Normally mounting mirror disk when mirroring is available, 1381, 1385  
 Not resolving network partition, 1222  
 Note, 863, 905, 910, 917, 922, 926, 931, 936, 960, 964, 1006, 1018, 1023, 1028, 1035, 1041, 1058, 1063, 1070, 1075, 1080, 1087, 1092, 1098, 1104, 1111  
 Note on, 1214  
 notes, 581, 752, 802, 808, 814, 1051, 1184, 1188, 1192, 1196, 1200, 1215  
 Notes, 772, 784, 798, 953, 977, 982, 992, 996, 999, 1167, 1208, 1233, 1238, 1240, 1250, 1257  
 Notes on, 695, 763  
 Notes on custom resources, 969  
 Notes on disk resources, 662  
 Notes on EXEC resources, 648  
 Notes on floating IP resources, 676  
 number of processes being run by a user, 1182, 1183  
 number of running processes by user, 1177  
 number of running processes per user, 1177  
 Number of running processes per user, 289  
 NX7700x/A2010M or NX7700x/A2010L series, 982, 1223, 1249

## O

Opening the configuration file, 155  
 Operating a cluster and cluster services, 41  
 Operating a cluster by using the WebManager, 116  
 Operating groups, 295, 401  
 Operating Mirror Disk Helper, 93  
 Operating the cluster, 295, 395, 399, 400  
 Operating the cluster from the command line, 296  
 Operation status check on Thread Pool of WebLogic Server, 1127  
 Operation status check on Work Manager of WebLogic Server, 1126  
 Operations, 58  
 Operations at detection of activation and inactivation errors, 576  
 Operations of EXPRESSCLUSTER when VERITAS volume manager fails, 1409  
 Oracle Clusterware linkage tab, 228  
 Oracle Clusterware Synchronization Management monitor resource, 1537  
 Oracle monitor resources, 1041  
 OracleAS monitor resources, 822, 1051  
 Output paths of log files, 414  
 Overview of the Builder, 142  
 Overview of the EXPRESSCLUSTER X Builder, 145

## P

Parameter details, 169  
 Parameters list, 242  
 PCI slot fencing(High-End Server Option) tab, 240  
 PID monitor resources, 1526, 936  
 PING network partition resolution resource, 1220  
 Pop up menu, 152  
 POP3 monitor resources, 822, 1058  
 Port No. (Log) tab, 184  
 Port No. tab, 181  
 PostgreSQL monitor resources, 1063  
 Power saving tab, 218  
 Preparing for using virtual IP resources, 691  
 process name monitor resources, 999  
 Process name monitor resources, 1536  
 Properties, 167

## R

raw device, 890  
 RAW monitor resource setting example, 893  
 READ is selected for the disk monitor resource, 893  
 Reboot count control command, 536  
 Reboot count limit, 582  
 recover mirror (forcefully), 102, 107  
 Recovering from mirror breaks, 1389  
 Recovering mirror using the WebManager, 1402  
 Recovering mirror with a command, 1393  
 Recovery, 1299, 1429, 1528, 1532  
 Recovery tab, 188  
 Recovery/pre-recovery action script, 860  
 Removing an object, 166  
 Renaming a group, 591, 621  
 Renaming a group resource, 605

---

Renaming an object, 167  
replace a server, 1279, 1313, 1323  
Replacing a server and a hybrid disk of the shared disk, 1325  
Requirement to use virtual IP address, 694  
Resetting the reboot count, 586  
Resource deactivation error, 1299  
Returning from monitor error (Normal), 848  
Running the forcible mirror recovery from the WebManager only on one Server, 1404  
Running the forcible mirror recovery using the WebManager, 1402  
Running the forcible mirror recovery with a command, 1393  
Running the forcible mirror recovery with a command only on one server, 1399  
running the mirror status display command, 463, 494

## S

Samba monitor resources, 1070  
sample environment, 1251  
Saving the configuration file, 156  
script before final action, 580  
Script for forced stop, 1235  
Scripts, 625  
Searching an alert, 29, 32, 85, 86  
Server properties, 229  
Set up the DDNS server before using DDNS resources, 797  
Setting individual servers, 885  
setting of group start dependence and group stop dependence, 600  
Setting of SIGTERM, 1225  
Setting PID monitor resources, 936  
Setting the disk heartbeat resources, 1210  
Setting usage limitations, 112  
Setting virtual IP monitor resources, 960  
Settings for VHOSTW monitor resources, 996  
Settings of the Microsoft Azure environment, 1260  
Settings of the PING network partition resolution resources, 1220  
Shutdown monitoring, 1224  
Shutdown monitoring method, 1224  
Shutting down a specified server, 295, 399  
Shutting down and rebooting an individual server, 116  
Shutting down the entire cluster, 295, 400  
Simulate Mode, 164  
SMTP monitor resources, 1075  
SNMP linkage, 1242  
SNMP trap sending, 1241  
Specifying log collector server, 415  
Stall detection, 1299  
Starting and stopping an individual resource, 116  
Starting, stopping, and moving an individual group, 116  
Status Descriptions, 304, 305, 306, 307, 391, 392  
Stopping mirror recovery, 106  
Suspending and resuming a monitor resource, 116  
Suspending and resuming an individual monitor resource, 116  
Suspending and resuming monitoring on monitor resources, 827

Switch authorization of the WebManager, 115  
Switching partitions, 660  
Switching the operation modes, 31  
Sybase monitor resources, 1080  
Syslog generations, 414  
system monitor resources, 1167  
System monitor resources, 1530  
System requirements, 910, 1035

## T

Table for cluster name selection, 146  
Table for group name selection, 150  
Table for group selection, 147  
Table for monitor resource selection, 151  
Table for server name selection, 147  
Table for server selection, 146  
Table view, 146  
target monitoring application, 887  
the settings of dependency among group resources, 606  
The settings of the kernel mode LAN heartbeat resources, 1208  
the total number of open files, 1182  
Thread operation status check on monitor target Java VM, 1124  
Thread tab, 1157  
Timeout tab, 180, 185  
tips for creating a script before final action, 581  
Tips for creating exec resource script, 647  
Tips for recovery/pre-recovery action script coding, 863  
To the judgment of network partition resolution, 1261  
Total memory usage, 288, 1176  
total number of open files, 1176, 1177, 1182  
Total number of open files, 289, 1176  
total number of threads, 1177, 1182  
Total number of threads, 289, 1177  
Total virtual memory usage, 288, 1176  
tree view, 27, 30, 42, 1172, 1180  
Tree view, 145  
Troubleshooting, 1366  
Troubleshooting problems with VERITAS volume manager, 1406  
Tuning exec resource, 656  
Tuning multi target monitor resource, 956  
Tuxedo monitor resources, 1087  
Type of limitation, 112

## U

umount processing flow, 728, 757  
Unavailable commands when interconnections are disconnected, 1380  
Understanding disk heartbeat resources, 1210  
Understanding kernel mode LAN heartbeat resources, 1208  
Understanding mirror disk resources, 706  
Understanding server groups, 620  
Understanding VHOSTW monitor resources, 996  
Understanding VM monitor resources, 992  
Understanding volume manager monitor resources, 977

Updating the WebManager information, 38  
Uploading, 153, 158  
Upper limits of registration, 294  
User-mode monitor logic, 942  
user-mode monitor resources, 940  
User-mode monitor resources, 1526  
Using a tool bar of the Builder, 153  
Using menu bar of the Builder, 154  
Using the disk of the failed server, 1329  
Using the mirror disk of the failed server, 1319, 1321

## V

VHOST group resources, 1520  
VHOSTW monitor resources, 1535  
View menu, 164  
virtual IP monitor resources, 960  
Virtual IP monitor resources, 1534  
Virtual IP resource, 1512  
virtual IP resources, 688  
Virtual IP resources, 688  
Virtual memory usage check on monitor target Java VM, 1126  
VM monitor resources, 1535  
VM resource, 783  
VM resources, 1519, 783  
Volume manager monitor resources, 1535  
volume manager resource, 771  
Volume Manager Resource, 771  
Volume manager resources, 1519

## W

Wait time for synchronized cluster startup, 1332

Waiting for monitor resource to start monitoring, 865  
Waiting process for floating IP resource deactivation, 679  
Warning Light, 233, 1240  
Warning Light tab, 232  
Warning light turning off command, 539  
Weblogic monitor resources, 1092  
WebLogic tab, 1159  
WebManager, 1180  
WebManager, 28, 153  
WebManager tab, 206  
WebOTX monitor resources, 1104  
Websphere monitor resources, 1098  
What are heartbeat resources, 1205, 1206  
What causes servers to shut down, 1296  
When a heartbeat time-out occurs, 1374  
When a kernel page allocation error occurs, 1365, 1412  
When a monitor resource error occurs, 1372  
When activating or deactivating group resources fails, 1372  
When all interconnection LANs are disconnected, 1378  
When network partitioning occurs, 1374  
when READ is selected for disk monitor resources, 892  
When the EXPRESSCLUSTER system does not start or end, 1366  
Window, 27, 28  
Writing exec resource scripts, 643  
Writing recovery/pre-recovery action scripts, 861